



Produtos de Transmissão de Potência

Productos de Transmisión de Potencia

Power Transmission Products

Correias em "V"

Correias em "V"

"V" Belts

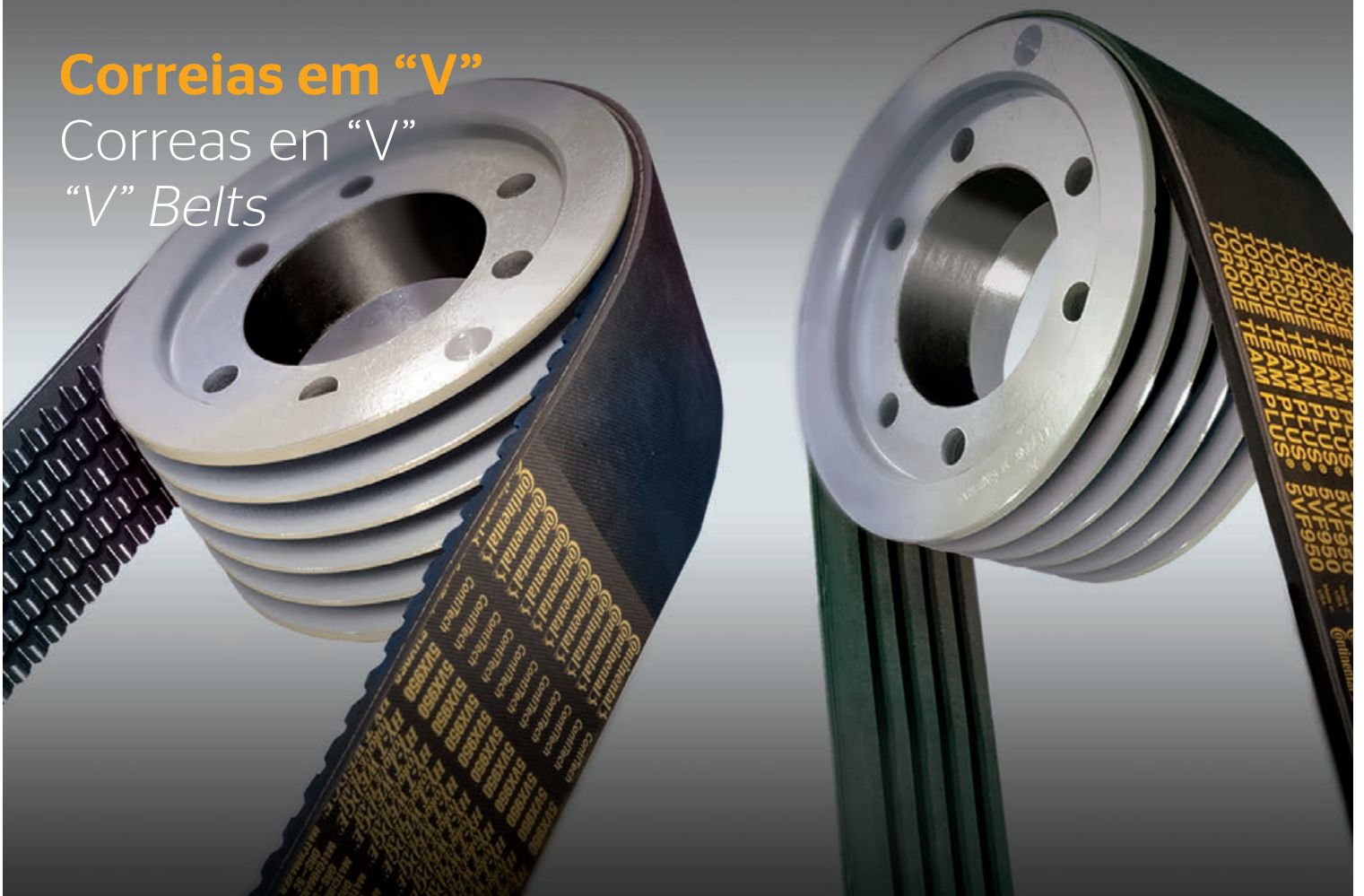

HY - T - Plus



Exemplo / Ejemplo / Example: B 180

Perfil	Largura da correia	Comprimento datum
Perfil	Ancho de la correia	Longitud datum
Profile	Top width	Datum length
B	17 mm	182.9"

Construção envelope em todos os tamanhos acima 120"
 Construcción envelope en todos los tamaños arriba 120"
 Envelope construction for all sizes up to 120"

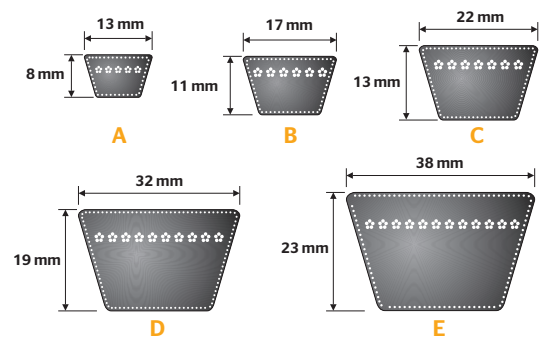

Torque Flex



Exemplo / Ejemplo / Example: AX 60

Perfil	Largura da correia	Comprimento datum
Perfil	Ancho de la correia	Longitud datum
Profile	Top width	Datum length
AX	13 mm	61.3"

Até 120" (inclusive): Construção Cut Edge (X)/Dentes moldados
 Hasta 120" (inclusive): Construcción Cut Edge (X)/Dientes Moldeados
 Up to 120" (included): Cut Edge (X)/Molded Cog construction

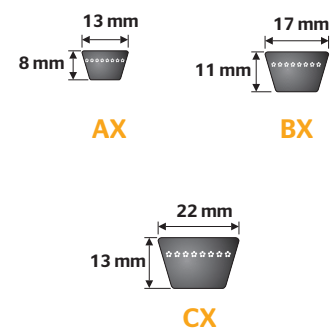

Torque Flex Classic

Exemplo / Ejemplo / Example: **A 60**

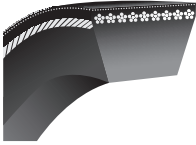

Perfil	Largura da correia	Comprimento datum
Perfil	Ancho de la correa	Longitud datum
Profile	Top width	Datum length
A	13 mm	61.3"

Até 120" (inclusive): Construção Cut Edge / Perfil liso
 Hasta 120" (inclusive): Construcción Cut Edge / Perfil liso
 Up to 120" (included): Cut Edge / Smooth profile

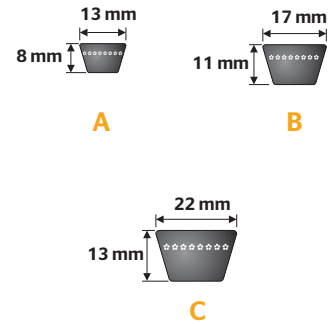

Metric

Exemplo / Ejemplo / Example: **XPA 1000**



Perfil	Largura da correia	Comprimento datum
Perfil	Ancho de la correa	Longitud datum
Profile	Top width	Datum length
XPA	13 mm	1000 mm

Até 3.050 mm (inclusive): Construção Cut Edge (X)/Dentes moldados
Acima 3.050 mm : Construção lisa
 Hasta 3.050 mm (inclusive): Construcción Cut Edge (X)/Dientes Moldeados
 Arriba 3.050 mm : Construcción lisa
 Up to 3.050 mm (included): Cut Edge (X)/Molded Cog construction
 Above 3.050 mm : Smooth construction

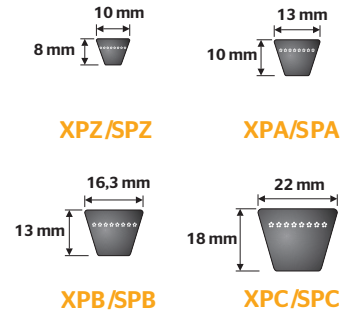

HY-T Wedge

Exemplo / Ejemplo / Example: **3VX 250**



Perfil	Largura da correia	Comprimento efetivo
Perfil	Ancho de la correa	Longitud efectiva
Profile	Top width	Effective length
3V	0,375"	25,0"

Até 118" (inclusive): Construção Cut Edge (X)/Dentes Moldados
Acima 118" : Construção envelope lisa
 Hasta 118" (inclusive): Construcción Cut Edge (X)/Dientes Moldeados
 Arriba 118" : Construcción envelope lisa
 Up to 118" (included): Cut Edge (X)/Molded Cog construction
 Above 118" : Smooth envelope construction

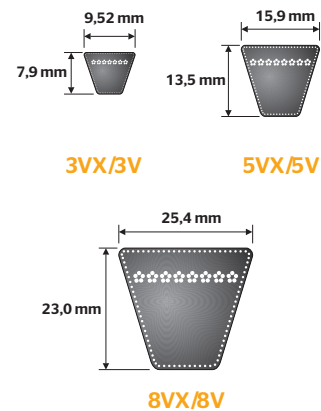

Torque Team

Fabricada nos modelos / Fabricado en los modelos / Manufactured in the models:

HY - T - PLUS, HY-T WEDGE, TORQUE FLEX, TORQUE FLEX CLASSIC e METRIC.

Exemplo / Ejemplo / Example: **3/3VX 400**

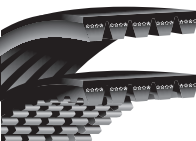

Número de ribs	Perfil	Largura da correia	Comprimento efetivo
Numero de ribs	Perfil	Ancho de la correa	Longitud efectiva
Number of ribs	Profile	Top width	Effective length
3	3VX	0,375"	40,0"

Até 118" (inclusive): Construção Cut Edge (X)/Dentes Moldados
Acima 118" : Construção envelope lisa
 Hasta 118" (inclusive): Construcción Cut Edge (X)/Dientes Moldeados
 Arriba 118" : Construcción envelope lisa
 Up to 118" (included): Cut Edge (X)/Molded Cog construction Above 118" : Smooth envelope construction

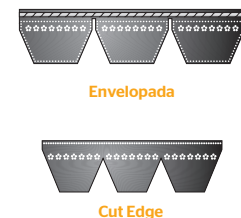

Fracionárias / Fraccionárias / Fractional



Exemplo / Ejemplo / Example: ZX 60

Perfil	Largura da correia	Comprimento Interno
Perfil	Ancho de la correa	Longitud Interior
Profile	Top width	Inner length
ZX	9,8 mm	60,0"

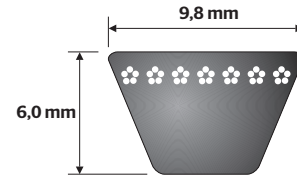

Poly-V

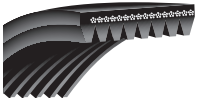

Exemplo / Ejemplo / Example: 6 PJ 600

Número de ribs	Perfil	Largura da correia	Comprimento efetivo
Numero de ribs	Perfil	Ancho de la correa	Longitud efectiva
Number of ribs	Profile	Top width	Effective length
6	J	14,04 mm	600 mm

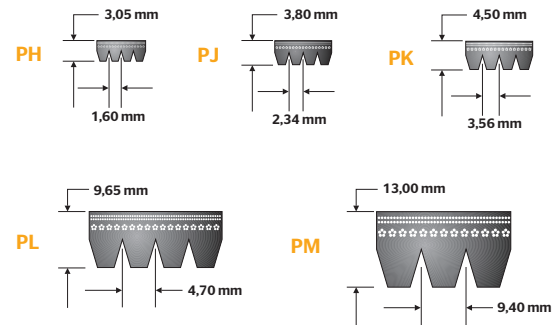

Variadoras de velocidade / Variadoras de velocidade / Variable speed

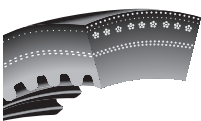

Exemplo / Ejemplo / Example: 3226V585

Perfil	Largura da correia	Comprimento Pitch
Perfil	Ancho de la correa	Longitud Pitch
Profile	Top width	Pitch length
V com 26 graus		
V with 26 degrees	32/16" = 50,8 mm	58,5"

Construção Envelope / Cut Edge / Dentes Moldados

Construcción Envelope / Cut Edge / Dientes Moldeados

Envelope Construction / Cut Edge / Molded Cog



Hexagonais / Hexagonales / Hex

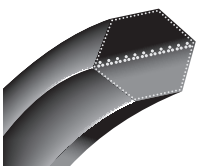

Exemplo / Ejemplo / Example: BB 75

Perfil	Largura da correia	Comprimento Pitch
Perfil	Ancho de la correa	Longitud Pitch
Profile	Top width	Pitch length
BB	0,66"	77,9"

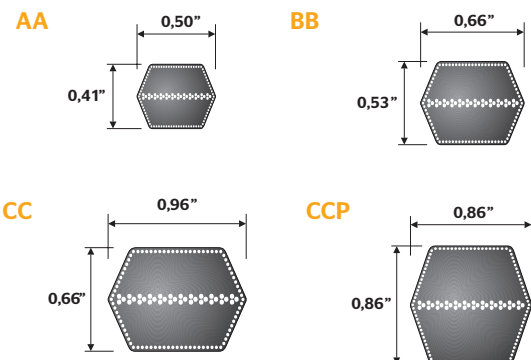

Correias sincronizadoras

Correas sincrónicas
Synchronous belts

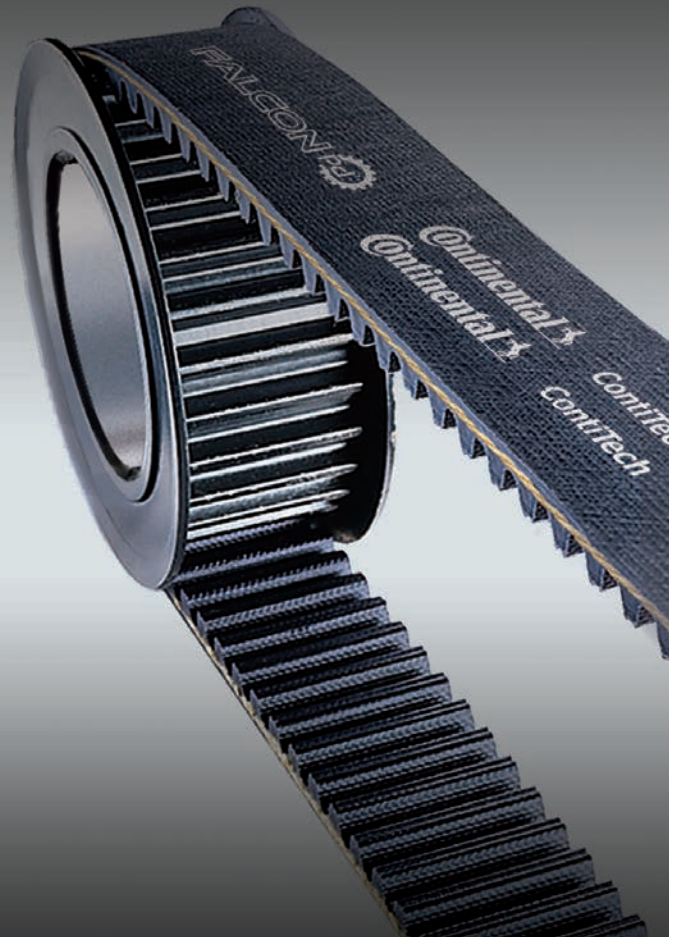

Positive Drive



Exemplo / Ejemplo / Example: 100 XL 025

Passo	Perfil	Largura da correia	Comprimento Pitch
Paso	Perfil	Ancho de la correia	Longitud Pitch
Pitch	Profile	Top width	Pitch length
0,200"	Trapezoidal	025=0,25"	100=10,0"

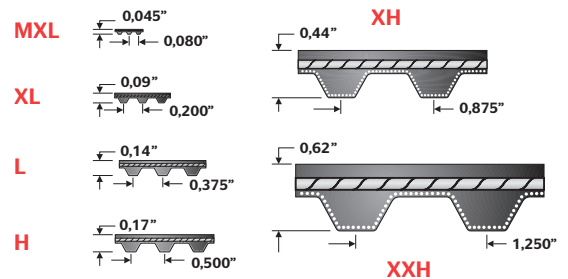

Dual Positive Drive



Exemplo / Ejemplo / Example: D 225 L 050

Passo	Perfil	Largura da correia	Comprimento Pitch
Paso	Perfil	Ancho de la correia	Longitud Pitch
Pitch	Profile	Top width	Pitch length
0,375"	Trapezoidal	050=0,50"	225=22,5"

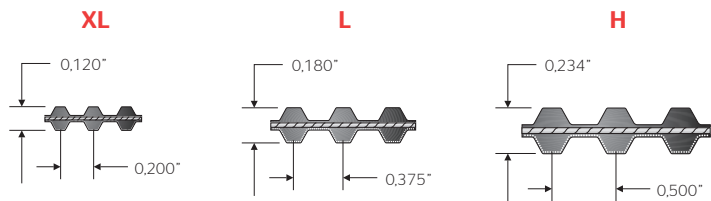

Dual Hi-Performance



Exemplo / Ejemplo / Example: **D1040 8M 20**

Passo	Perfil	Largura da correia	Comprimento Pitch
Paso	Perfil	Ancho de la correa	Longitud Pitch
Pitch	Profile	Top width	Pitch length
	Arredondado		
	Redondeado		
8 mm	Round	20=20 mm	1040=1040 mm

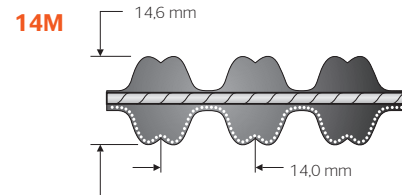
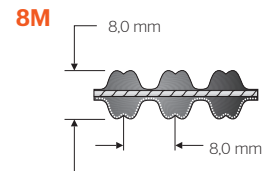

Super Toque PD



Exemplo / Ejemplo / Example: **100 S5M 375**

Passo	Perfil	Largura da correia	Comprimento Pitch
Paso	Perfil	Ancho de la correa	Longitud Pitch
Pitch	Profile	Top width	Pitch length
	Arredondado		
	Redondeado		
5 mm	Round	100=10,0 mm	375=375 mm

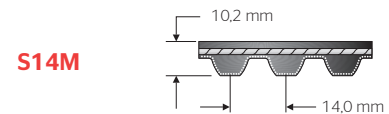
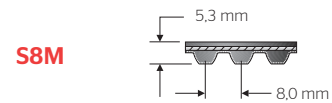
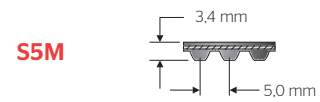

Hawk PD



Exemplo / Ejemplo / Example: **800 8M 50**

Passo	Perfil	Largura da correia	Comprimento Pitch
Paso	Perfil	Ancho de la correa	Longitud Pitch
Pitch	Profile	Top width	Pitch length
	Arredondado		
	Redondeado		
8 mm	Round	50=50 mm	800=800 mm

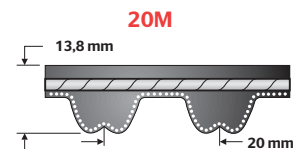
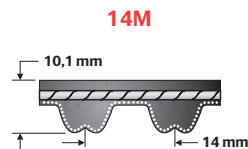
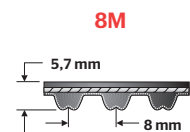
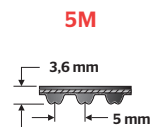

Black Hawk PD



Exemplo / Ejemplo / Example: 2310 14BH 115

Passo	Perfil	Largura da correia	Comprimento Pitch
Paso	Perfil	Ancho de la correa	Longitud Pitch
Pitch	Profile	Top width	Pitch length
14 mm	Arredondado Redondeado Round	115=115,0 mm	2310=2310 mm

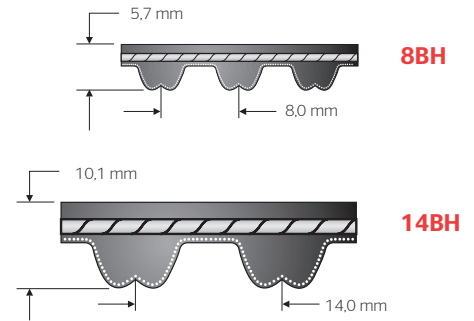

Falcon PD



Exemplo / Ejemplo / Example: 8GTR-640-12

Passo	Perfil	Largura da correia	Comprimento Pitch
Paso	Perfil	Ancho de la correa	Longitud Pitch
Pitch	Profile	Top width	Pitch length
8 = 8 mm	Circular	12=12,0 mm	640=640 mm

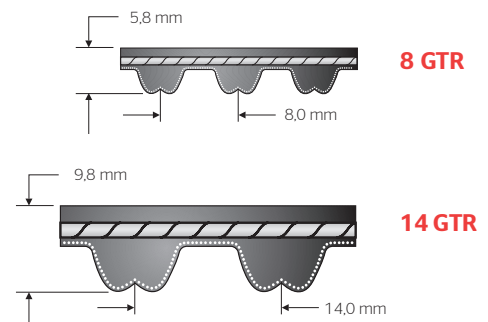

Silent Sync

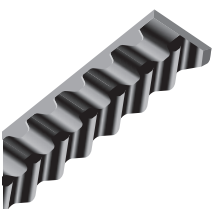

Exemplo / Ejemplo / Example: Y-640

Cor	Passo	Perfil	Largura da correia	Comprimento Pitch
Color	Paso	Perfil	Ancho de la correa	Longitud Pitch
Colour	Pitch	Profile	Top width	Pitch length
Yellow	8 mm	HOT*	16 mm	640 mm

Modelo / Modelo / Model:

Cor	Passo	Perfil	Largura da correia	Comprimento Pitch
Color	Paso	Perfil	Ancho de la correa	Longitud Pitch
Colour	Pitch	Profile	Top width	Pitch length
Yellow	8 mm	HOT	16 mm	640 mm / 2400 mm
White	8 mm	HOT	32 mm	640 mm / 2400 mm
Purple	8 mm	HOT	64 mm	720 mm / 1600 mm
Blue	14 mm	HOT	35 mm	994 mm / 3920 mm
Green	14 mm	HOT	52.5 mm	994 mm / 3920 mm
Orange	14 mm	HOT	70 mm	1120 mm / 3920 mm
Red	14 mm	HOT	105 mm	1260 mm / 3920 mm

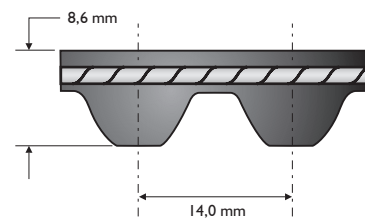
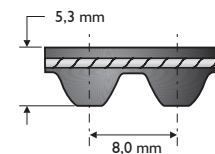

* **HOT:** Helical Offset Tooth
Dente Helicoidal
Diente Helicoidal

ContiTech



Brasil

Rodovia Presidente Castelo Branco,
Km 32 + 354,6m, nº 2.555 - Itapevi - SP
CEP 06696-100
email: sac.contitech@contitech.com.br

Argentina

Av. Cabildo 2677 - 4º. piso A (C1428AAI)
Ciudad de Buenos Aires - Argentina
Phone: (+5411) 4896-2444
Mail: infoargentina@contitech.com.ar

Chile

Avenida José Luis Caro 1635
Padre Hurtado - Santiago
Teléfono: (56-2) 2 4955300 - 2 4955339
Email: ventaschile@contitech.cl

Venezuela

Carretera Nacional Valencia-Tinaquillo
KM 46, Tinaquillo. Edo Cojedes - Venezuela
Phone: +58 258 4002111
4002102 4002132



Visite nosso site:

www.contitech.com.br

ContiTech. Engenharia em alto nível.

Uma divisão do Grupo Continental, a ContiTech é sinônimo de inovação e liderança em borracha natural e plásticos. Somos parceiros da indústria e enxergamos o futuro à nossa frente, nossos engenheiros desenvolvem soluções com e para os nossos clientes em todo o mundo. Essas soluções sob medida são criadas para atender as necessidades do mercado. Com grande experiência em materiais e processos, somos capazes de desenvolver tecnologias de ponta, com utilização responsável dos recursos. Somos rápidos para responder às tendências tecnológicas mais importantes, como a integração de funções, engenharia leve e redução da complexidade, e oferecer uma gama de produtos e serviços relevantes. Dessa forma, quando você precisar de nós, você vai encontrar, pois já estamos lá.

Continental 
The Future in Motion

O conteúdo aqui apresentado não é juridicamente vinculativo e é fornecida apenas como informação. As marcas exibidos aqui são de propriedade da Continental AG e/ou suas afiliadas. Copyright© Continental AG. Todos os direitos reservados. Para obter informações completas acesse contitech.de/disci_en e consulte o seu país de origem.

09002-01/15