

# BEARING DIMENSION CATALOG

- EXPLANATION OF TIMKEN® BEARING SYMBOLS
- BEARING DIMENSIONS BY PART NUMBER
- BEARING DIMENSIONS BY CORE BORE

PROUDLY MANUFACTURED  
IN TIMKEN COMPANY  
PLANTS THROUGHOUT  
THE WORLD

NOT TO BE USED AS A DESIGN MANUAL

MEMBER BEARING DIMENSION CATALOG 699

# TIMKEN

WORLDWIDE LEADER IN BEARINGS AND STEEL

# BEARING DIMENSION CATALOG

## INCLUDES:

- EXPLANATION OF TIMKEN® BEARING SYMBOLS
- BEARING DIMENSIONS BY PART NUMBER
- BEARING DIMENSIONS BY CORE BORE

## BEARING COMPONENTS ARE SHOWN IN BOTH METRIC AND INCH UNITS.

For each part number the top line is millimeters, bottom line is inches.

## BEARING COMPONENT WEIGHTS ARE SHOWN IN BOTH METRIC AND POUND UNITS.

For each part number the top line is kilograms, bottom line is pounds.

## NOT TO BE USED AS A DESIGN MANUAL

This is not a manual for the selection of bearings for new applications. Whenever it is necessary to select Timken bearings for new applications consult the Bearing Selection Handbook or get in touch with the nearest office of The Timken Company.

Every effort has been made to ensure that the data listed in this catalog is correct. However, we cannot assume responsibility for possible error.

©COPYRIGHT 1999 BY THE TIMKEN COMPANY

## INDEX

### EXPLANATION OF TIMKEN BEARING SYMBOLS

1. FITTING PRACTICES
2. 5A THRU 935 SERIES
3. 1100 THRU 9900 SERIES
4. 00000 THRU LM29700 SERIES
5. 29800 THRU 99000 SERIES
6. 100000 THRU HH249900 SERIES
7. 250000 THRU 299000 SERIES
8. LM300800 THRU 690000 SERIES
9. 700000 THRU LL989300 SERIES
10. IsoClass™
11. BEARING TYPES  
UNIT-BEARING™  
DUO-FACE® PLUS SEAL  
STEERING GEAR  
CROSSED ROLLER  
THRUST  
HYDRA-RIB™  
UNIPAC™
12. K PARTS
13. NP & XC PARTS
14. AUXILIARY PARTS
15. CONE BORE SECTION

---

## WARNING!

### **Failure to observe the following warnings could lead to a risk of serious bodily harm:**

- Never spin a bearing with compressed air. The rollers may be forcefully expelled.
- If a hammer and bar are used for bearing removal, fragments from the hammer, bar, or the bearing can be released with high velocity.  
*NOTE: A mild steel bar is preferred since it is less susceptible to fragmenting.*
- When installing or removing bearings, always wear safety glasses or goggles.

### **Failure to observe the following instructions can result in equipment failure leading to a risk of serious bodily harm:**

- Proper maintenance and handling practices are critical. Follow installation instructions and maintain proper lubrication.
- Do not attempt to disassemble unitized bearings. Components may be damaged.
- Do not use a damaged bearing.
- Do not mix parts of matched assemblies. Bearing damage could result.

Actual bearing performance is affected by many factors beyond the control of The Timken Company. Therefore, the feasibility of all bearing applications should be validated by the customer. The data contained in this guide is intended for reference purposes and will assist you in part number and external bearing dimension identification.

## TAPERED ROLLING BEARING – BASIC DESIGN

Considering the performance demands placed on tapered roller bearings, it's rather amazing how simple the basic design really is. Timken tapered roller bearings minimize friction because of the interrelationship of the bearing's four basic parts:

- The inner ring, or cone, is mounted onto the shaft.
- The outer ring, or cup, sits in the housing (hub).
- The tapered rollers, or rolling elements, allow relative motion between the cone and cup thus minimizing friction between the two.
- The cage, or separator, spaces and holds the rolling elements in the proper position.
- The races are the surfaces on the cup and cone where the rolling elements make contact.

The tapered roller bearing's most important dimensions are:

- The outside diameter of the outer ring, or cup, is known as the O.D. (D). The other basic dimension of this part is the cup width (C). Both are important for fitting the bearing onto the housing.
- The inside diameter of the inner ring, or cone is called the bore (d). This diameter must be correct in order to fit the bearing onto the shaft. The other basic dimension of this part is the cone width (B).
- When cup and cone are mated (including rollers and cage), the overall dimension is called the overall bearing width (T).

Bearing components or assemblies must be in alignment. Their fit onto a shaft or within a housing must be square or in alignment by checking:

- The maximum shaft radius (R), which allows the cone backface to make contact with the shoulder of the shaft.
- The maximum housing radius (r), which allows the cup backface to make contact with the shoulder of the housing.

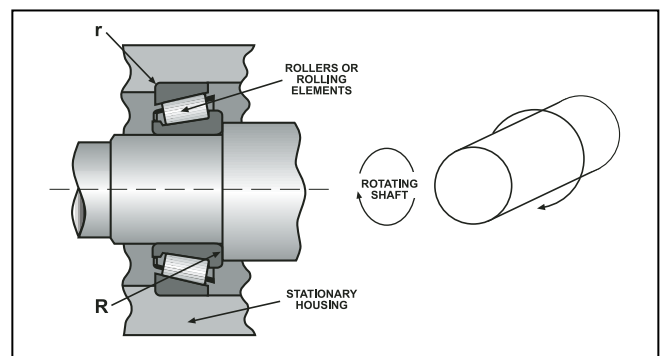
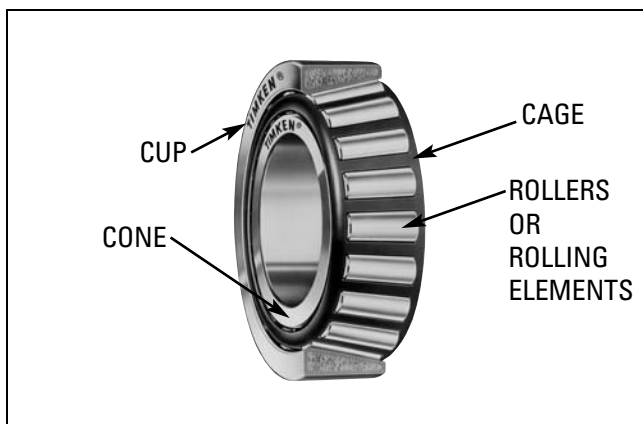
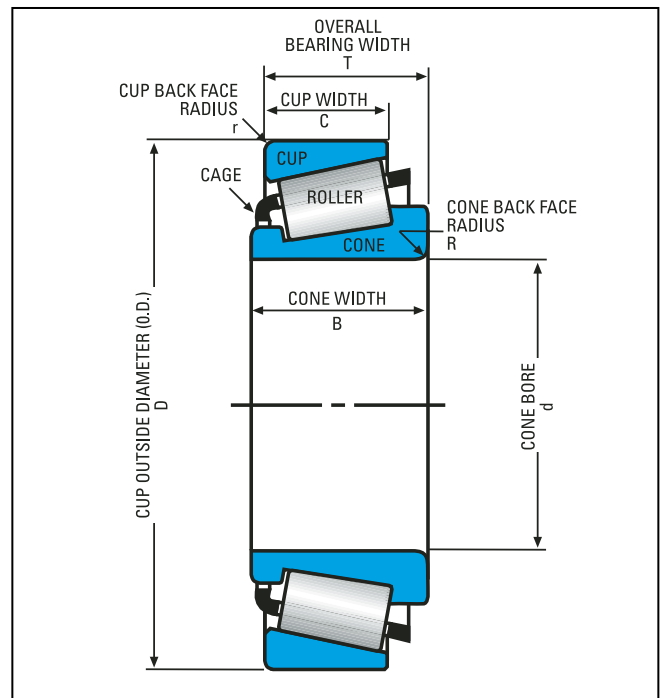
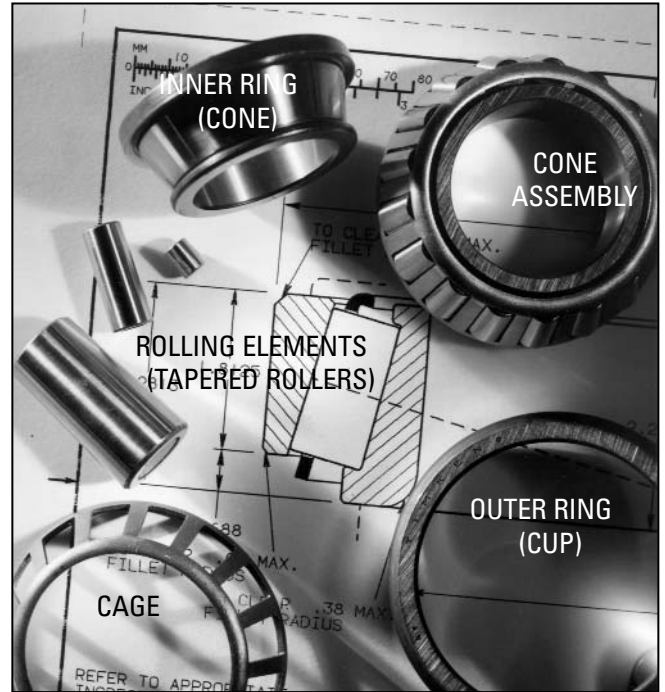

## TAPERED ROLLER BEARINGS – SPACER ASSEMBLIES

### Spacer Bearing Assemblies

Spacer bearing assemblies speed up bearing installation time because there is no need for bearing adjustment. Spacer bearing assemblies are suitable for use with two-row and four-row Timken® tapered roller bearings to preset the bench lateral (bench end play). Most matched bearing assemblies have serial numbers to ensure correct installation sequence.

Timken spacer bearings are precisely ground to provide the exact bench lateral required for the particular bearing application.

**Since each spacer is custom-fitted to a particular set of components, a spacer cannot be used with any other bearing components – even if they carry the same part numbers.**

**When ordering replacement bearing assemblies, specify:**

- cone number
- assembly number.

**If you do not have the assembly number, specify the component part numbers including:**

- cone number
- cup number
- spacer number
- bench end play, which is etched on the spacer.

**If you do not have any part numbers for the spacer assembly, specify:**

- Name of equipment
- Model number
- Year
- Application position of the bearing.

**WARNING: Always follow manufacturer's instructions. Failure to follow all instructions and to properly lubricate the bearing can cause equipment failure, creating a risk of serious bodily harm.**

**Over-filling or under-filling a wheel hub with lubricant may result in premature component failure. Creating a risk of serious bodily harm.**

**Never spin a bearing with compressed air. The rollers may be forcefully expelled, creating a risk of serious bodily harm.**

**DO NOT MIX PARTS.**



### Tapered Double Outer (TDO)

This diagram depicts the way spacers are used between the cone front faces in the TDO bearing. The spacer fits between the two single cones.

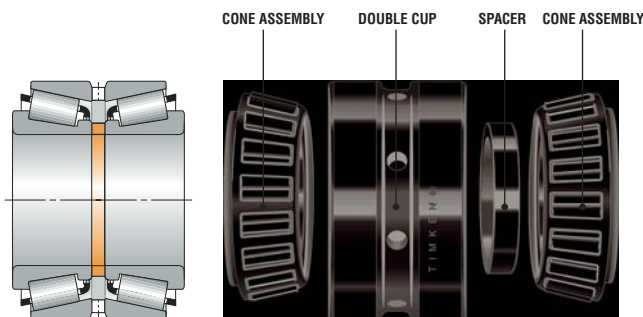

### Tapered Double Inner (TDI)

Here is an example of how spacers are used between the cup front faces in the type TDI bearing. The spacer fits between the two single cups.

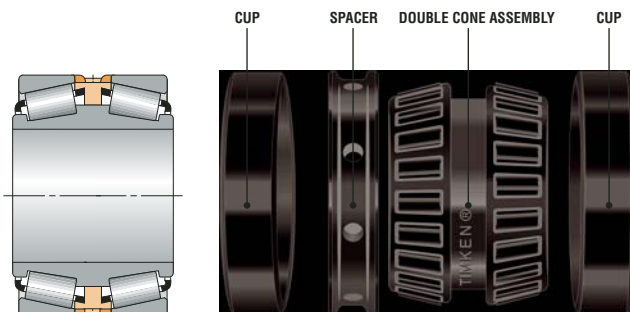

**This guide contains the basic information for most general-use parts in production by The Timken Company. The data contained within this guide is intended for reference purposes and will assist you in part number and external bearing dimension identification.**

**What you will find**

- Cup and cone combinations are grouped by series designation. Dimensional information, inch and metric form, is provided for each cup and cone combination and includes the following:

NOMENCLATURE	DIMENSION SYMBOL
• bore size	“d”
• outside diameter (O.D.)	“D”
• bearing width	“T”
• cone width	“B”
• cup width	“C”
• shaft and housing max fillet radii	“R” for cones – “r” for cups
• bearing weight	

- Where additional characteristics are important to differentiate between parts, the part number is preceded by an asterisk (\*). These characteristics are available in the remarks column.

**How to find part numbers**

- **If you know the part number**, use the index to locate the section where you will find the part. Once in that section, series are arranged in ascending order.
- **If you only know the cone bore dimension**, use the section titled BEARING DIMENSION BY CONE BORE to find an appropriate series.

## TAPERED ROLLER BEARING PART NUMBER PREFIXES AND SUFFIXES

PREFIX	SUFFIX	CONE OR CUP	EXPLANATION
A		Cone & Cup	Standard basic series part number.
	A	Cone	Different bore from basic part number.
	A	Cone	Different complement of rollers.
	A	Cone	Different radius from basic part number.
	A	Cup	Different OD from basic part number.
	A	Cup	Different radius from basic part number.
	A	Cup	Different width from basic part number.
	AA	Cone & Cup	Different bore, OD, width, or radius from basic part number.
	AB	Cone	Different bore, width, or radius from basic part number, assembled with brass cage.
	AB	Cup	Flanged cup. (Non-interchangeable with basic part number.)
	AC	Cone	Different bore or radius, different internal geometry.
	AC	Cup	Different OD, width, or radius from basic part number.
	AD	Cup	Double cup. (Non-interchangeable with basic part number.)
	ADW	Cone	Double cone. Pilots and slots each end, holes in large rib.
	AH	Cone	Assembled with special cage, rollers, and/or Duo-Face internal geometry. (Non-interchangeable with basic part number.)
	AL	Cone	Assembled with Duo-Face seal.
	ARB	Cup	Single cup with snap ring groove in OD.
	AS	Cone & Cup	Different bore, OD, width, or radius from basic part number.
	ASB	Cone	Single cone, different bore or width from basic part number, assembled with brass cage.
	AV	Cone & Cup	Made of special steel.
	AW	Cone & Cup	Keyway or slotted cone or cup.
	AX	Cone & Cup	Different bore, OD, width, or radius from basic part number.
	AXB	Cone	Different bore, width, or radius from basic part number, assembled with brass cage.
	AXD	Cup	IsoClass cup - double cup without oil holes or groove.
	AXV	Cone & Cup	Different OD, width, or radius from basic part number. Made of special steel.
	AXX	Cone & Cup	Different OD, width, or radius from basic part number. Made of special steel.
	B	Cup	Flanged cup. (Non-interchangeable with basic part number.)
	B	Cone & Cup	IsoClass bearing with same boundary dimensions as basic part number, but with different internal geometry, steeper included cup angle.
	BA	Cup	Flanged cup. (Non-interchangeable with basic part number.)
	BNA	Cone	IsoClass cone used in assemblies with 2 cones mated with double cup to form a double row non-adjustable bearing. (Non-interchangeable with other cones having the same basic part numbers which may vary in bore or width dimensions.)
	BR	Cup	Single cup with groove in OD for snap ring.
	BS	Cup	Flanged cup. (Non-interchangeable with basic part number.)
	BW	Cup	Flanged cup with slot. (Non-interchangeable with basic part number.)
	BXX	Cup	Flanged single cup. Made of special steel.
	C	Cone	Single cone, envelope dimensions same as basic part number, different internal geometry.
	C	Cup	Dimensionally different from basic part number. (Non-interchangeable).
	CA	Cone	Single cone, envelope dimensions same as basic part number, different internal geometry.
	CB	Cone	Single cone, dimensionally different from basic part number.



## TAPERED ROLLER BEARING PART NUMBER PREFIXES AND SUFFIXES

PREFIX	SUFFIX	CONE OR CUP	EXPLANATION
	CD	Cup	Double cup with oil holes and groove. One hole counter-bored for locking pin.
	CE	Cup	Dimensionally different from basic part number. (Non-interchangeable.)
CN		Cup	Neoprene cushioned cup.
	CP	Cone & Cup	Flash chrome plated. Otherwise, interchangeable with basic part number.
	CP	Cone & Cup	Envelope dimensions same as basic part number, different internal geometry, customized for performance.
	CR	Cone & Cup	Ribbed cup bearing series.
	CS	Cone & Cup	Dimensionally different from basic part number. (Non-interchangeable.)
	CX	Cone	Dimensionally different from basic part number. (Non-interchangeable.)
	D	Cone & Cup	Double cone or Double cup. (Non-interchangeable with basic part number.)
	DA	Cone	Double cone. (Non-interchangeable with cones having same basic part number.)
	DA	Cup	Spherical OD double cup. (Non-interchangeable with basic part number or other double cups having same basic numbers.)
	DB	Cup	Double cup with flange. (Non-interchangeable with basic part number or double cups having same basic numbers.)
	DB	Cone	Double cone assembled with brass cages.
	DC	Cup	Double cup with hole for locking pin.
	DD	Cone & Cup	Special long double cone or cup. (Non-interchangeable with basic part number or other double parts having same basic numbers.)
	DE	Cone & Cup	Double cone or double cup having different dimensions or other characteristics from single and double parts identified with same basic part number.
	DF	Cup	Double cup with oil holes and groove. Snap ring groove on OD.
	DG	Cone	Double cone with groove in bore.
	DGW	Cone	Double cone with pressure removal groove in bore, and having face slots.
	DH	Cone	Double cone with special cage, rollers, and/or internal geometry. (Non-interchangeable with basic part number.)
	DP	Cone	Double cone with puller groove.
	DR	Cup	Double cup for ribbed cup series. (Non-interchangeable with single and double cups identified with same basic part number.)
	DRB	Cup	Double cup with snap ring groove.
	DS	Cup	Crowned OD double cup. (Non-interchangeable with other cups having same basic part numbers.)
	DT	Cup	Tapered OD double cup. (Non-interchangeable with other cups having same basic part numbers.)
	DV	Cone & Cup	Double cone or double cup made of special steel.
	DVH	Cone	Double cone, special steel, and/or internal geometry. (Non-interchangeable with basic part number.)
	DW	Cone & Cup	Double cone or double cup with keyway or slot. (Non-interchangeable with cones or cups identified with same basic part numbers.)
	DWA	Cone	Double cone with one end extended and with oil slots in extended end.
	DWH	Cone	Double cone with oil slots, assembled with special cage, rollers, and/or internal geometry. (Non-interchangeable with basic part number.)
	DWV	Cone & Cup	Double cone or double cup with keyway or slot. (Non-interchangeable with cones or cups identified with same basic part numbers.) Made of special steel.

## TAPERED ROLLER BEARING PART NUMBER PREFIXES AND SUFFIXES

PREFIX	SUFFIX	CONE OR CUP	EXPLANATION
	DX	Cup	Adaptor for spherical or straight OD cup.
	DXX	Cone & Cup	Double cone or double cup made of special steel.
	E	Cone & Cup	Cones or cups having special characteristics differing from and non-interchangeable with other cones or cups identified with the same basic part numbers.
	ED	Cup	Double cup. (Non-interchangeable with other cups identified with same basic part numbers.)
	EDC	Cup	Double cup, special hole in OD for locking pin.
EE		Cone	Large and small ribs - close guided rollers. (Non-interchangeable with other cones identified with same basic part numbers.)
EH		Cone & Cup	Extra heavy series.
EL		Cone & Cup	Extra light series.
EX		Cone & Cup	Experimental.
	EXX	Cone & Cup	Cones or cups having special characteristics differing from and non-interchangeable with other cones or cups identified with the same basic part numbers. Made of special steel.
	F	Cone	Assembled with polymer cage.
FL		Cone & Cup	"Free lateral" series, no large or small ribs.
FX		Cone & Cup	Factory identification number only.
	G	Cone	Retainer groove in bore.
H		Cone & Cup	Heavy series. (Non-interchangeable with other cones and cups identified with same basic part numbers.)
	H	Cone	Assembled with special cage, rollers, and/or internal geometry. (Non-interchangeable with basic part number.)
	HV	Cone	Assembled with special cage, rollers, and/or internal geometry. Made of special steel. (Non-interchangeable with basic part number.)
HH		Cone & Cup	Heavy-Heavy series. (Non-interchangeable with other cones and cups identified with same basic part numbers.)
HM		Cone & Cup	Heavy-Medium series. (Non-interchangeable with other cones and cups identified with same basic part numbers.)
	HP	Cone	Assembled with special cage and/or roller, different internal geometry. Customized for performance. (Non-interchangeable with basic part number.)
	HR	Cup	Special cup used on "Hydra-Rib" bearing. (Non-interchangeable with basic part number.)
J		Cone & Cup	Used alone or with other prefix letters to indicate metric bore and/or OD.
JC		Cone & Cup	Metric Series.
JD		Cone & Cup	Metric Series.
JE		Cone & Cup	Metric Series.
JF		Cone & Cup	Metric Series.
JG		Cone & Cup	Metric Series.
JN		Cone & Cup	Metric Series.
JP		Cone & Cup	Metric Series.
JR		Cone & Cup	Metric Series.
JRM		Cone & Cup	Metric Series, UNIPAC™ bearing.
JS		Cone & Cup	Metric Series.
JT		Cone & Cup	Metric Series.
JU		Cone & Cup	Metric Series.
JW		Cone & Cup	Metric Series.
K		Cup	Double cup with heavy section. May have unusual feature such as flange. (Non-interchangeable with basic part number.)

## TAPERED ROLLER BEARING PART NUMBER PREFIXES AND SUFFIXES

PREFIX	SUFFIX	CONE OR CUP	EXPLANATION	
L	KP	Thrust Bearing Cone & Cup	Cadmium plated. Light series. (Non-interchangeable with other cones and cups identified with same basic part numbers.)	
	L	Cone	Cone assembled with Duo-Face seal.	
	L	Cup	Loose rib. (Part of Unit-Bearing.)	
	LA	Cone	Cone assembled with Duo-FaceX seal and with "O" ring groove in bore.	
	LA, LB,	Seal	These suffixes are used on a basic Duo-Face-Plus seal number to identify the assembly resulting from the use of the seal various cones in the series.	
LL		Cone & Cup	Light-Light series.	
LM		Cone & Cup	Light-Medium series.	
M		Cone & Cup	Medium series.	
N		Cone	Bock or Gilliam type bearings.	
NA	NA	Cone	Two cones mated with double cup to form double row non-adjustable bearing. (Non-interchangeable with other cones having same basic part numbers which may vary in bore, OD, and width dimensions.)	
	NA	Cup	Etched electric pencil or double cups mated with two "NA" type single cones to form double row non-adjustable bearings.	
	NAV	Cone	"NA" cone made of special steel.	
	NC	Cup	Cushioned cup (usually neoprene).	
	NI	Cup	Tapered or threaded bore.	
	NP		Cone & Cup	Used with random numbers for product differentiation.
		NR	Cone	"NA" type ribless cone for ribbed cup series.
	NW	Cone	"NA" type cone with slotted front face.	
	NWV	Cone	"NA" type cone with slotted front face. Made of special steel.	
	NX	Cone	Lapped front face.	
	P	Cone	Puller groove.	
R	P	Cone & Cup Cone & Cup	Customized for performance. Gilliam replacement series. (Non-interchangeable with other cones and cups identified with same basic numbers.)	
	R	Cone & Cup	Special feature bearing. (Non-interchangeable with bearings having the same basic part numbers.)	
	R	Cone & Cup	Bock type bearing.	
	R	Cone	Basic part number with polymer lubricant.	
RC	RB	Cup	Snap ring on OD.	
		Cone & Cup	Special ribbed cup bearing.	
	RN	Various	Used with random numbers, not to exceed six (6) digits, for purchased items that are distributed by Timken.	
	RR	Cone & Cup	"Relieved race."	
	S	Cone & Cup	Special feature bearing. (Non-interchangeable with bearings having same basic part numbers.)	
	SA	Cone & Cup	Special feature bearing. (Non-interchangeable with bearings having same basic part numbers.)	
	SB	Cone	Assembled with brass cage. (Non-interchangeable with basic part number.)	
	SB	Cup	Flanged cup. (Non-interchangeable with basic part number.)	
	SC	Cone	With square bore. (Non-interchangeable with basic part number.)	
	SD	Cone & Cup	Double cone with square bore or double cup. (Non-interchangeable with basic part number.)	
	SH	Cone	Special feature bearing, with special cage, rollers, and/or internal geometry. (Non-interchangeable with bearings having same basic part numbers.)	

## TAPERED ROLLER BEARING PART NUMBER PREFIXES AND SUFFIXES

PREFIX	SUFFIX	CONE OR CUP	EXPLANATION
	SL	Thrust Bearing	Basic part number with polymer lubricant.
	SR	Cone	Different radius from basic part numbers.
	SW	Cone & Cup	Slot or keyway. (Non-interchangeable with bearings having same basic part numbers.)
	SWB	Cone	Slot or keyway assembled with brass cage. (Non-interchangeable with bearings having same basic part numbers.)
	SWV	Cone	Slot or keyway made of special steel. (Non-interchangeable with bearings having same basic part numbers.)
	SX	Cup	Special feature bearing. (Non-interchangeable with bearings having same basic part numbers.)
T		Race	Thrust bearing assemblies.
T		Cup	Double cup with heavy section. May have unusual feature such as flange, tapered OD, etc.
	T	Cone	Tapered bore. (Non-interchangeable with basic part number.)
	T	Cup	Tapered OD. (Non-interchangeable with basic part number.)
	TA	Cone	Tapered bore "NA" type cone. (Non-interchangeable with basic part number.)
	TA	Cup	Tapered OD. (Non-interchangeable with basic part number.)
	TB	Cone	Tapered bore cone with brass cage. (Non-interchangeable with basic part number.)
TC		Race	Thrust bearing assembly.
	TC	Cone	Tapered bore. (Non-interchangeable with basic part number.)
	TD	Cone	Double with tapered bore. (Non-interchangeable with basic part number.)
	TDB	Cone	Double with tapered bore, assembled with brass cages. (Non-interchangeable with basic part number.)
	TDE	Cone	Double with tapered bore and extended rib. (Non-interchangeable with basic part number.)
	TDG	Cone	Double with tapered bore, groove in bore. (Non-interchangeable with basic part number.)
	TDGV	Cone	Double with tapered bore, groove in bore. Made of special steel. (Non-interchangeable with basic part number.)
	TDH	Cone	Double with tapered bore, special cage, rollers or internal geometry. (Non-interchangeable with basic part number.)
	TDL	Cone	Double with tapered bore, interlock feature. (Non-interchangeable with basic part number.)
	TDV	Cone	Double with tapered bore. Made of special steel. (Non-interchangeable with basic part number.)
	TDW	Cone	Double with tapered bore and slots or keys. (Non-interchangeable with basic part number.)
	TDXX	Cone	Double with tapered bore. Made of special steel. (Non-interchangeable with basic part number.)
	TE	Cone	Single, tapered bore, extended large rib. (Non-interchangeable with basic part number.)
	TEV	Cone	Single, tapered bore, extended large rib. Made of special steel. (Non-interchangeable with basic part number.)
	TL	Cone	Tapered bore with interlock feature. Non-interchangeable with basic part number.)
	TLE	Cone	Tapered bore with interlock feature and extended rib. (Non-interchangeable with basic part number.)
	TP	Cone	Tapered bore cone with puller groove. (Non-interchangeable with basic part number.)

**TAPERED ROLLER BEARING PART NUMBER PREFIXES AND SUFFIXES**

<b>PREFIX</b>	<b>SUFFIX</b>	<b>CONE OR CUP</b>	<b>EXPLANATION</b>
	TPE	Cone	Tapered bore cone with puller groove, extended large rib. (Non-interchangeable with basic part number.)
	TPV	Cone	Tapered bore cone. Made of special steel. (Non-interchangeable with basic part number.)
	TW	Cone & Cup	Tapered bore cone or cup OD with slots or keys. (Non-interchangeable with basic part number.)
	TWE	Cone & Cup	Tapered bore cone or cup OD with locking keyway in front face, extended larger rib. (Non-interchangeable with basic part number.)
	TXX	Cone	Tapered bore. Made of special steel. (Non-interchangeable with basic part number.)
U		Cone & Cup	Basic series part number, unitized, self-contained.
	U	Cone & Cup	Basic series part number, unitized, self-contained.
	US	Cone & Cup	Special close stand.
V		Cone & Cup	Special close stand.
	V	Cone & Cup	Made of special steel.
	VC	Cone	Special internal geometry. Made of special steel. (Non-interchangeable with basic part number.)
	VH	Cone	Special cage, rollers, and/or internal geometry. Made of special steel. (Non-interchangeable with basic part number.)
	W	Cone & Cup	Slot(s) or keyway(s).
	W	Thrust Bearing	Oil holes in retainer.
	WB	Cone	Slot(s) or keyway(s) with brass cage.
	WC	Cone	Slot(s) or keyway(s).
	WD	Cone	Double cone with slot(s) or keyway(s).
	WE	Cone & Cup	Extended face with slot(s) or keyway(s). (Non-interchangeable with basic part number.)
	WS	Cone & Cup	Slot(s) or keyway(s).
	WV	Cone & Cup	Slot(s) or keyway(s). Made of special steel.
	WXX	Cone & Cup	Slot(s) or keyway(s). Made of special steel.
X		Cone	IsoClass part number.
	X	Cone	Slot(s) or keyway(s).
	X	Cone & Cup	Special feature bearing. (Non-interchangeable with bearings having the same basic part number.)
	X	Cone & Cup	IsoClass bearing with same boundary dimensions as basic part number but with different internal geometry, yielding increased rating.
	XA	Cone & Cup	Special feature bearing. (Non-interchangeable with bearings having the same basic part number.)
XAA		Cone	IsoClass single cone. (Non-interchangeable with bearings having the same basic part number.)
XAB		Cone	IsoClass single cone. (Non-interchangeable with bearings having the same basic part number.)
	XB	Cone	Different bore, width, or radius, from basic part number. Assembled with brass cage. (Non-interchangeable with basic part number.)
	XB	Cup	Special feature flanged cup. (Non-interchangeable with bearings having the same basic part number.) (Non-interchangeable with basic part number.)
XC		Cone & Cup	Limited production bearings to which standard series part numbers have not been assigned.
	XD	Cup	Double cup, no oil holes or groove.
	XD	Cone	Double cone, different bore or width from basic part numbers. Double cone, oil holes in large rib.

## TAPERED ROLLER BEARING PART NUMBER PREFIXES AND SUFFIXES

PREFIX	SUFFIX	CONE OR CUP	EXPLANATION
	XDXP	Cup	Double cup, no oil holes or groove, special material and process.
	XE	Cup	Different bore, width, or radius from basic part number.
XGA		Cone	IsoClass single cone. (Non-interchangeable with bearings having the same basic part number.)
XGB		Cone	IsoClass single cone. (Non-interchangeable with bearings having the same basic part number.)
	XP	Cone	Special steel and process.
XR			Crossed roller bearing series.
	XS	Cone & Cup	Different bore, width, or radius from basic part number.
	XS	Cone	Double.
	XV	Cone & Cup	Special feature cone or cup made of special steel.
	XW	Cone	Slotted.
	XX	Cone & Cup	Single cone or single cup. Made of special steel.
Y		Cup	IsoClass part number.
	YD	Cup	Double cup with oil holes, no groove. (Non-interchangeable with basic part number.)
	YDA	Cup	Double cup with oil holes, no groove. (Non-interchangeable with bearings having the same basic part number.)
	YDV	Cup	Double cup with oil holes, no groove. Made of special steel.
	YDW	Cone	Double cup with oil holes, no groove. Slot(s) or keyway(s) in face(s).
	YKA	Cup	IsoClass single cup. (Non-interchangeable with bearings having the same basic part number.)
YKB		Cup	IsoClass single cup. (Non-interchangeable with bearings having the same basic part number.)
YSA		Cup	IsoClass single cup. (Non-interchangeable with bearings having the same basic part number.)
	Z	Cone & Cup	Close stand part.

**INTRODUCTION**

Mounting a bearing with the proper fit helps ensure the bearing will function as desired. In general, the rotating race must be mounted with a tight fit. A loose fit is used on a stationary cone or on a double cup, especially at the floating position. Cups mounted in an aluminum housing must have minimum tight fit of .001 times the cup O.D. For magnesium housings, the minimum tight fit must be .0015 times the cup O.D. The fitting practices listed within this catalog are specific to industrial applications. **Automotive bearings** require special fitting practices.

**Precision bearings** require a special fit that depends on the precision class of the bearing used. In addition to the proper fit and bearing alignment, the desired accuracy of the spindle, cup and cone seat roundness, and square backing shoulders for both the cup and the cone are very critical. Less than desirable spindle runout will likely result if any of these areas are out of tolerance. A complete discussion showing recommended fits, cup seat and cone seat roundness and backing squareness is found in the booklet "Timken Bearings For Machine Tools".

**Rolling mill bearings** also require special fitting practices depending on the type of bearing involved. Refer to the Timken booklet "Rolling Mill Bearings" for a complete discussion of fitting practices.

**MACHINED SURFACE FINISHES FOR SHAFTS AND HOUSINGS**

The cup and cone seats should be smooth and within specified tolerances for size, roundness and taper. Ground finish is usually recommended for shafts whenever possible. The recommended finish for ground and turned surfaces is as follows:

- Cone seats - ground 63 micro-inches AA (maximum) (1.6 micrometer).
- Cone seats - turned 125 micro-inches AA (maximum) (3.2 micrometer).

If the bearing seat finishes are rougher than these limits, there is not enough contact area and the fit will loosen easily, especially if the race is pressed on and off several times.

The following tables show machined finishes for shafts and housings and the recommended fitting practice for both inch and metric sizes.

**INCH SYSTEM BEARINGS  
CONE FITTING PRACTICE (inches)**

**CLASS: 4 AND 2 CONES**

CONE BORE			DEVIATION FROM MINIMUM CONE BORE AND RESULTANT FIT											
Range		Tolerance  Does not apply to TNASW and TNASWE type bearings.	ROTATING CONE		ROTATING OR STATIONARY CONE		STATIONARY CONE							
			Ground Seat	Constant Loads With Moderate Shock	Unground or Ground Seat Heavy Loads, or High Speed or Shock	Unground Seat	Ground Seat	Moderate Loads, No Shock	Moderate Loads, No Shock	Sheaves, Wheels, Idlers	Hardened and Ground Seat Wheel Spindles			
Over	Inclusive		Cone Seat Deviation	Resultant Fit	Cone Seat Deviation	Resultant Fit	Cone Seat Deviation	Resultant Fit	Cone Seat Deviation	Resultant Fit	Cone Seat Deviation	Resultant Fit	Cone Seat Deviation	Resultant Fit
0	3.0000	0.0000 +0.0005	+0.0015 +0.0010	0.0015T 0.0005T	+0.0025 +0.0015	0.0025T 0.0010T	+0.0005 0.0000	0.0005T 0.0005L	0.0000 -0.0005	0.0000 0.0010L	0.0000 -0.0005	0.0000 0.0010L	-0.0002 -0.0007	0.0002L 0.0012L
3.0000	12.0000	0.0000 +0.0010	+0.0025 +0.0015	0.0025T 0.0005T	Use Average Tight Cone Fit of 0.0005 in./in. of Cone Bore		+0.0010 0.0000	0.0010T 0.0010L	0.0000 -0.0010	0.0000 0.0020L	0.0000 -0.0010	0.0000 0.0020L	-0.0002 -0.0012	0.0002L 0.0022L
12.0000	24.0000	0.0000 +0.0020	+0.0050 +0.0030	0.0050T 0.0010T			+0.0020 0.0000	0.0020T 0.0020L	0.0000 -0.0020	0.0000 0.0040L	0.0000 -0.0020	0.0000 0.0040L	— —	— —
24.0000	36.0000	0.0000 +0.0030	+0.0075 +0.0045	0.0075T 0.0015T			+0.0030 0.0000	0.0030T 0.0030L	0.0000 -0.0030	0.0000 0.0060L	0.0000 -0.0030	0.0000 0.0060L	— —	— —

**EXAMPLE:** If the minimum cone bore = 3.0000 inches, the suggested shaft size = 3.0015 in. to 3.0010 in for a cone fit of 0.0015 in tight to 0.0005 in tight.

## INDUSTRIAL FITTING PRACTICES

### INCH SYSTEM BEARINGS CUP FITTING PRACTICE (inches)

### CLASS: 4 AND 2 CUPS

CUP OD			DEVIATION FROM MINIMUM CUP OD AND RESULTANT FIT							
Range		Tolerance	STATIONARY CUP				STATIONARY OR ROTATING CUP		ROTATING CUP	
			Floating or Clamped		Adjustable		Non Adjustable or in Carriers, Sheaves - Clamped		Sheaves - Unclamped ‡	
Over	Inclusive		Cup Seat Deviation	Resultant Fit	Cup Seat Deviation	Resultant Fit	Cup Seat Deviation	Resultant Fit	Cup Seat Deviation	Resultant Fit
0	3.0000	+0.0010 0.0000	+0.0020 +0.0030	0.0010L 0.0030L	0.0000 +0.0010	0.0010T 0.0010L	-0.0015 -0.0005	0.0025T 0.0005T	-0.0030 -0.0020	0.0040T 0.0020T
3.0000	5.0000	+0.0010 0.0000	+0.0020 +0.0030	0.0010L 0.0030L	0.0000 +0.0010	0.0010T 0.0010L	-0.0020 -0.0010	0.0030T 0.0010T	-0.0030 -0.0020	0.0040T 0.0020T
5.0000	12.0000	+0.0010 0.0000	+0.0020 +0.0030	0.0010L 0.0030L	0.0000 +0.0020	0.0010T 0.0020L	-0.0020 -0.0010	0.0030T 0.0010T	-0.0030 -0.0020	0.0040T 0.0020T
12.0000	24.0000	+0.0020 0.0000	+0.0040 +0.0060	0.0020L 0.0060L	+0.0010 +0.0030	0.0010T 0.0030L	-0.0030 -0.0010	0.0050T 0.0010T	-0.0040 -0.0020	0.0060T 0.0020T
24.0000	36.0000	+0.0030 0.0000	+0.0060 +0.0090	0.0030L 0.0090L	+0.0020 +0.0050	0.0010T 0.0050L	-0.0040 -0.0010	0.0070T 0.0010T	-	-

### INCH SYSTEM BEARINGS CONE FITTING PRACTICE (MICROMETERS)

### CLASS: 4 AND 2 CONES

CONE BORE			DEVIATION FROM MINIMUM CONE BORE AND RESULTANT FIT														
Range mm		Tolerance µm	ROTATING CONE		ROTATING OR STATIONARY CONE		STATIONARY CONE										
			Ground Seat		Unground or Ground Seat		Unground Seat		Ground Seat		Unground Seat		Hardened and Ground Seat				
Over	Inclusive	Does not apply to TNASW and TNASWE type bearings.	Constant Loads with Moderate Shock	Heavy Loads, or High Speed or Shock	Moderate Loads, No Shock	Moderate Loads, No Shock	Sheaves, Wheels, Idlers	Wheel Spindles									
			Cone Seat Deviation	Resultant Fit	Cone Seat Deviation	Resultant Fit	Cone Seat Deviation	Resultant Fit	Cone Seat Deviation	Resultant Fit	Cone Seat Deviation	Resultant Fit	Cone Seat Deviation	Resultant Fit	Cone Seat Deviation	Resultant Fit	
0	72.200	0 +13	+38 +25	38T 12T	+64 +38	64T 25T	+13 0	13T 13L	0 -13	0 26L	0 -13	0 26L	-5 -18	5L 31L			
76.200	304.800	0 +25	+64 +38	64T 13T	Use Average Tight Cone Fit of 0.5µm/mm of Cone Bore.	+25 0	25T 25L	0 -25	0 50L	0 -25	0 50L	0 -25	0 50L	-5 -30	5L 55L		
304.800	609.600	0 +51	+127 +76	127T 25T		+51 0	51T 51L	0 -51	0 102L	0 -51	0 102L	0 -51	0 102L	— —	— —		
609.600	914.400	0 +76	+190 +114	190T 38T		+76 0	76T 76L	0 -76	0 152L	0 -76	0 152L	0 -76	0 152L	— —	— —		

**EXAMPLE:** If the minimum cone bore = 75.000 mm, the suggested shaft size = 75.038 mm to 75.025 mm, for a cone fit of 0.038 mm tight to 0.012 mm tight.

‡ Unclamped cup design is applicable only to sheaves with negligible fleet angle



**INCH SYSTEM BEARINGS  
CUP FITTING PRACTICE (MICROMETERS)**

**CLASS: 4 AND 2 CUPS**

CUP OD			DEVIATION FROM MINIMUM CUP OD AND RESULTANT FIT							
Range (mm)		Tolerance (µm)	STATIONARY CUP				STATIONARY OR ROTATING CUP		ROTATING CUP	
			Floating or Clamped		Adjustable		Nonadjustable or in Carriers, Sheaves-Clamped		Sheaves-Unclamped ‡	
Over	Inclusive		Cup Seat Deviation	Resultant Fit	Cup Seat Deviation	Resultant Fit	Cup Seat Deviation	Resultant Fit	Cup Seat Deviation	Resultant Fit
0	76.200	+25 0	+51 +76	26L 76L	0 +25	25T 25L	-38 -13	63T 13T	-76 -51	101T 51T
76.200	127.000	+25 0	+51 +76	26L 76L	0 +25	25T 25L	-51 -25	76T 25T	-76 -51	101T 51T
127.000	304.800	+25 0	+51 +76	26L 76L	0 +51	25T 51L	-51 -25	76T 25T	-76 -51	101T 51T
304.800	609.600	+51 0	+102 +152	51L 152L	+26 +76	25T 76L	-76 -25	127T 25T	-102 -51	153T 51T
609.600	914.400	+76 0	+152 +229	76L 229L	+51 +127	25T 127L	-102 -25	178T 25T	— —	— —

**FOR METRIC "J" PREFIX AND IsoClass PARTS  
CUP FITTING PRACTICE (INCHES)**

**CLASS: K AND N CUPS**

CUP OD			DEVIATION FROM MAXIMUM CUP OD AND RESULTANT FIT											
Range		Tolerance	STATIONARY CUP						ROTATING CUP					
			Floating or Clamped			Adjustable			Non adjustable or in Carriers			Nonadjustable or in Carriers, Sheaves-Clamped		
Open	Inclusive		Cup Seat Deviation	Resultant Fit	Sym- bol	Cup Seat Deviation	Resultant Fit	Sym- bol	Cup Seat Deviation	Resultant Fit	Sym- bol	Cup Seat Deviation	Resultant Fit	Sym- bol
0.7087	1.1811	0.0000 -0.0005	+0.0003 +0.0011	0.0003L 0.0016L	G7	-0.0003 +0.0005	0.0003T 0.0010L	J7	-0.0013 -0.0005	0.0013T 0.0000	P7	-0.0017 -0.0009	0.0017T 0.0004T	R7
1.1811	1.9685	0.0000 -0.0006	+0.0004 +0.0014	0.0004L 0.0020L	G7	-0.0004 +0.0006	0.0004T 0.0011L	J7	-0.0016 -0.0006	0.0016T 0.0000	P7	-0.0020 -0.0010	0.0020T 0.0004T	R7
1.9685	3.1496	0.0000 -0.0006	+0.0004 +0.0016	0.0004L 0.0022L	G7	-0.0004 +0.0008	0.0004T 0.0014L	J7	-0.0021 -0.0009	0.0021T 0.0003T	P7	-0.0023 -0.0011	0.0023T 0.0005T	R7
3.1496	4.7244	0.0000 -0.0007	+0.0005 +0.0019	0.0005L 0.0026L	G7	-0.0005 +0.0009	0.0005T 0.0016L	J7	-0.0025 -0.0011	0.0025T 0.0004T	P7	-0.0029 -0.0015	0.0029T 0.0008T	R7
4.7244	5.9055	0.0000 -0.0008	+0.0006 +0.0022	0.0006L 0.0030L	G7	-0.0006 +0.0010	0.0006T 0.0018L	J7	-0.0028 -0.0012	0.0028T 0.0004T	P7	-0.0035 -0.0019	0.0035T 0.0011T	—
5.9055	7.0866	0.0000 -0.0010	+0.0006 +0.0022	0.0006L 0.0032L	G7	-0.0006 +0.0010	0.0006T 0.0020L	J7	-0.0028 -0.0012	0.0028T 0.0002T	P7	-0.0035 -0.0019	0.0035T 0.0009T	—
7.0866	9.8425	0.0000 -0.0012	+0.0006 +0.0024	0.0006L 0.0036L	G7	-0.0007 +0.0011	0.0007T 0.0023L	J7	-0.0032 -0.0014	0.0032T 0.0002T	P7	-0.0042 -0.0024	0.0042T 0.0012T	R7
9.8425	12.4016	0.0000 -0.0014	+0.0007 +0.0027	0.0007L 0.0041L	G7	-0.0007 +0.0013	0.0007T 0.0027L	J7	-0.0034 -0.0014	0.0034T 0.0000	P7	-0.0047 -0.0027	0.0047T 0.0013T	R7
12.4016	15.7480	0.0000 -0.0016	+0.0025 +0.0039	0.0025L 0.0055L	F6	-0.0007 +0.0015	0.0007T 0.0031L	J7	-0.0039 -0.0017	0.0039T 0.0001T	P7	-0.0059 -0.0037	0.0059T 0.0021T	R7
15.7480	19.6850	0.0000 -0.0018	+0.0028 +0.0038	0.0028L 0.0056L	F5	-0.0009 +0.0016	0.0009T 0.0034L	J7	-0.0044 -0.0019	0.0044T 0.0001T	P7	-0.0066 -0.0041	0.0066T 0.0023T	R7
19.6850	24.8032	0.0000 -0.0020	+0.0026 +0.0045	0.0026L 0.0065L	—	-0.0009 +0.0018	0.0009T 0.0038L	—	-0.0046 -0.0020	0.0046T 0.0000	—	-0.0070 -0.0042	0.0070T 0.0022T	—
24.8032	31.4961	0.0000 -0.0031	+0.0030 +0.0059	0.0030L 0.0090L	—	-0.0010 +0.0020	0.0010T 0.0051L	—	-0.0059 -0.0030	0.0059T 0.0001L	—	— —	— —	—
31.4961	39.3701	0.0000 -0.0039	+0.0030 +0.0069	0.0030L 0.0108L	—	-0.0010 +0.0030	0.0010T 0.0069L	—	-0.0079 -0.0039	0.0079T 0.0000	—	— —	— —	—

‡ Unclamped cup design is applicable only to sheaves with negligible fleet angle

# 1 INDUSTRIAL FITTING PRACTICES

FOR "J" PREFIX AND ISO PARTS  
CONE FITTING PRACTICE (INCHES)

CLASS: K AND N CONES

CONE BORE			DEVIATION FROM MAXIMUM CONE BORE AND RESULTANT FIT																	
			ROTATING CONE			ROTATING OR STATIONARY CONE			STATIONARY CONE											
Range		Tolerance	Ground Seat Constant Loads with Moderate Shock			Unground or Ground Seat Heavy Loads, or High Speed or Shock			Unground Seat Moderate Loads, No Shock			Ground Seat Moderate Loads, No Shock			Unground Seat Sheaves, Wheels, Idlers			Hardened and Ground Seat Wheel Spindles		
Over	Inclusive		Cone Seat Deviation	Resultant Fit	Sym- bol	Cone Seat Deviation	Resultant Fit	Sym- bol	Cone Seat Deviation	Resultant Fit	Sym- bol	Cone Seat Deviation	Resultant Fit	Sym- bol	Cone Seat Deviation	Resultant Fit	Sym- bol	Cone Seat Deviation	Resultant Fit	Sym- bol
0.3937	0.7087	-0.0005 0.0000	+0.0007 +0.0003	0.0012T 0.0003T	m6	+0.0009 +0.0005	0.0014T 0.0005T	n6	0.0000 -0.0004	0.0005T 0.0004L	h6	-0.0025 -0.0065	0.00025T 0.00065L	g6	-0.0025 -0.0065	0.00025T 0.00065L	g6	-0.0006 -0.0011	0.0001L 0.0010L	f6
0.7087	1.1811	-0.0005 0.0000	+0.0008 +0.0003	0.0013T 0.0003T	m6	+0.0011 +0.0006	0.0016T 0.0006T	n6	0.0000 -0.0005	0.0005T 0.0005L	h6	-0.0003 -0.0008	0.0002T 0.0008L	g6	-0.0003 -0.0008	0.0002T 0.0008L	g6	-0.0008 -0.0013	0.0003L 0.0013L	f6
1.1811	1.9685	-0.0005 0.0000	+0.0010 +0.0004	0.0015T 0.0004T	m6	+0.0013 +0.0007	0.0018T 0.0007T	n6	0.0000 -0.0006	0.0005T 0.0006L	h6	-0.0004 -0.0010	0.0001T 0.0010L	g6	-0.0004 -0.0010	0.0001T 0.0010L	g6	-0.0010 -0.0016	0.0005L 0.0016L	f6
1.9685	3.1496	-0.0006 0.0000	+0.0012 +0.0005	0.0018T 0.0005T	m6	+0.0015 +0.0008	0.0021T 0.0008T	n6	0.0000 -0.0007	0.0006T 0.0007L	h6	-0.0004 -0.0011	0.0002T 0.0011L	g6	-0.0004 -0.0011	0.0002T 0.0011L	g6	-0.0012 -0.0019	0.0006L 0.0019L	f6
3.1496	4.7244	-0.0008 0.0000	+0.0014 +0.0005	0.0022T 0.0005T	m6	+0.0019 +0.0010	0.0027T 0.0010T	n6	0.0000 -0.0009	0.0008T 0.0009L	h6	-0.0005 -0.0014	0.0003T 0.0014L	g6	-0.0005 0.0014	0.0003T 0.0014L	g6	-0.0014 -0.0023	0.0006L 0.0023L	f6
4.7244	7.0866	-0.0010 0.0000	+0.0022 +0.0022	0.0032T 0.0012T	n6	+0.0028 +0.0018	0.0038T 0.0018T	p6	0.0000 -0.0010	0.0010T 0.0010L	h6	-0.0006 -0.0016	0.0004T 0.0016L	g6	-0.0006 -0.0016	0.0004T 0.0016L	g6	-0.0016 -0.0026	0.0006L 0.0026L	f6
7.0866	9.8425	-0.0012 0.0000	+0.0026 +0.0014	0.0038T 0.0014T	n6	+0.0042 +0.0030	0.0054T 0.0030T	r6	0.0000 -0.0012	0.0012T 0.0012L	h6	-0.0006 -0.0018	0.0006T 0.0018L	g6	-0.0006 -0.0018	0.0006T 0.0018L	g6	-0.0020 -0.0032	0.0008L 0.0032L	f6
9.8425	12.4016	-0.0014 0.0000	+0.0026 +0.0014	0.0040T 0.0014T	n6	+0.0055 +0.0035	0.0069T 0.0035T	r7	0.0000 -0.0012	0.0014T 0.0012L	h6	-0.0007 -0.0019	0.0007T 0.0019L	g6	-0.0007 -0.0019	0.0007T 0.0019L	g6	-0.0022 -0.0034	0.0008L 0.0034L	f6
12.4016	15.7480	-0.0016 0.0000	+0.0030 +0.0016	0.0046T 0.0016T	n6	+0.0067 +0.0045	0.0083T 0.0045T	r7	0.0000 -0.0014	0.0016T 0.0014L	h6	-0.0007 -0.0029	0.0009T 0.0029L	g7	-0.0007 -0.0029	0.0009T 0.0029L	g7	—	—	—
15.7480	19.6850	-0.0018 0.0000	+0.0034 +0.0018	0.0052T 0.0018T	n6	+0.0075 +0.0050	0.0093T 0.0050T	r7	0.0000 -0.0016	0.0018T 0.0016L	h6	-0.0008 -0.0033	0.0010T 0.0033L	g7	-0.0008 -0.0033	0.0010T 0.0033L	g7	—	—	—
19.6850	24.8032	-0.0020 0.0000	+0.0039 +0.0020	0.0059T 0.0020T	—	+0.0079 +0.0050	0.0099T 0.0050T	—	0.0000 -0.0020	0.0020T 0.0020L	—	-0.0020 -0.0039	0.0000 0.0039L	—	-0.0020 -0.0039	0.0000 0.0039L	—	—	—	—
24.8032	31.4961	-0.0031 0.0000	+0.0049 +0.0020	0.0080T 0.0020T	—	+0.0089 +0.0059	0.0120T 0.0059T	—	0.0000 -0.0030	0.0031T 0.0030L	—	-0.0031 -0.0059	0.0000 0.0059L	—	-0.0031 -0.0059	0.0000 0.0059L	—	—	—	—
31.4961	39.3701	-0.0039 0.0000	+0.0059 +0.0020	0.0098T 0.0020T	—	+0.0108 +0.0069	0.0147T 0.0069T	—	0.0000 -0.0039	0.0039T 0.0039L	—	-0.0039 -0.0079	0.0000 0.0079L	—	-0.0039 -0.0079	0.0000 0.0079L	—	—	—	—

FOR "J" PREFIX AND ISO PARTS  
CUP FITTING PRACTICE (MICROMETERS)

CLASS: K AND N CUPS

CUP OD			DEVIATION FROM MAXIMUM CUP OD AND RESULTANT FIT											
Range (mm)		Tolerance (µm)	STATIONARY CUP									ROTATING CUP		
			Floating or Clamped			Adjustable			Nonadjustable or in Carriers			Nonadjustable or in Carriers or Sheaves-Clamped		
Open	Inclusive		Cup Seat Deviation	Resultant Fit	Sym-bol	Cup Seat Deviation	Resultant Fit	Sym-bol	Cup Seat Deviation	Resultant Fit	Sym-bol	Cup Seat Deviation	Resultant Fit	Sym-bol
18	30	0 -12	+7 +28	7L 40L	G7	-9 +12	9T 24L	J7	-35 -14	35T 2T	P7	-41 -20	41T 8T	R7
30	50	0 -14	+9 +34	9L 48L	G7	-11 +14	11T 28L	J7	-42 -17	42T 3T	P7	-50 -25	50T 11T	R7
50	65	0	+10	10L	G7	-12	12T	J7	-51	51T	P7	-60	60T	R7
65	80	-16	40	56L		+18	34L		-21	5T		-62 -32	62T 16T	
80	100	0	+12	12L	G7	-13	13T	J7	-59	59T	P7	-73	73T	R7
100	120	-18	47	65L		+22	34L		-24	6T		-76 -41	76T 23T	
120	150	0 -20	+14 +54	14L 74L	G7	-14 +26	14T 46L	J7	-68 -28	68T 8T	P7	-89 -48	89T 28T	—
150	180	0 -25	+14 +54	14L 79L	G7	-14 +260	14T 51L	J7	-68 -28	68T 3T	P7	-89 -48	89T 23T	—
180	200	0 -30	+15 +61	15L 91L	G7	-16 +30	16T 60L	J7	-79 -33	79T 3T	P7	-106	106T	R7
200	225											-60	30T	
225	250											-109 -63	109T 33T	
250	280	0	+17	17L	G7	-16	16T	J7	-88	88T	P7	-126	126T	R7
280	315	-35	+69	104L		+36	71L		-36	1T		-74 -130 -78	39T 130T 43T	
315	355	0	+62	62L	G7	-18	18T	J7	-98	98T	P7	-144	144T	R7
355	400	-40	+98	138L		+39	79L		-41	1T		-87 -150 -93	47T 150T 53T	
400	450	0	+68	68L	G7	-20	20T	J7	-108	108T	P7	-166	166T	R7
450	500	-45	+95	140L		+43	88L		-45	0		-103 -172 -109	58T 172T 64T	
500	630	0 -50	+65 +115	65L 165L	—	-22 +46	22T 96L	—	-118 -50	118T 0	—	-190 -120	190T 70T	—
630	800	0 -80	+75 +150	75L 230L	—	-25 +50	25T 130L	—	150 -75	150T 5L	—	—	—	—
800	1000	0 -100	+75 +175	75L 275L	—	-25 +75	25T 175L	—	-200 -100	200T 0	—	—	—	—

# 1 INDUSTRIAL FITTING PRACTICES

FOR "J" PREFIX AND ISO PARTS  
CONE FITTING PRACTICE (MICROMETERS)

CLASS: K AND N CONES

CONE BORE			DEVIATION FROM MAXIMUM CONE BORE AND RESULTANT FIT																	
		Tolerance	ROTATING CONE			ROTATING OR STATIONARY CONE			STATIONARY CONE											
Range			Ground Seat Constant Loads with Moderate Shock			Unground or Ground Seat Heavy Loads, or High Speed or Shock			Unground Seat Moderate Loads, No Shock			Ground Seat Moderate Loads No Shock			Unground Seat Sheaves, Wheels, Idlers			Hardened and Ground Seat Wheel Spindles		
Open	Inclusive		Cone Seat Deviation	Resultant Fit	Sym-bol	Cone Seat Deviation	Resultant Fit	Sym-bol	Cone Seat Deviation	Resultant Fit	Sym-bol	Cone Seat Deviation	Resultant Fit	Sym-bol	Cone Seat Deviation	Resultant Fit	Sym-bol	Cone Seat Deviation	Resultant Fit	Sym-bol
10	18	-12 0	+18 +7	30T 7T	m6	+23 +12	35T 12T	m6	0 -11	12T 011L	h6	-6 -17	6T 17L	g6	-6 -17	6T 17L	g6	-16 -27	4L 27L	f6
18	30	-12 0	+21 +8	33T 8T	m6	+28 +15	40T 15T	m6	0 -13	12T 13L	h6	-7 -20	5T 20L	g6	-7 -20	5T 20L	g6	-20 -33	8L 33L	f6
30	50	-12 0	+25 +9	37T 9T	m6	+33 +17	45T 17T	m6	0 -16	12T 16L	h6	-9 -25	3T 25L	g6	-9 -25	3T 25L	g6	-25 -41	13L 41L	f6
50	80	-15 0	+30 +11	45T 11T	m6	+39 +20	54T 20T	m6	0 -19	15T 19L	h6	-10 -29	5T 29L	g6	-10 -29	5T 29L	g6	-30 -49	15L 49L	f6
80	120	-20 0	+35 +13	55T 13T	m6	+45 +23	65T 23T	m6	0 -22	20T 22L	h6	-12 -34	8T 34L	g6	-12 -34	8T 34L	g6	-36 -58	16L 58L	f6
120	180	-25 0	+52 +27	77T 27T	m6	+68 +43	93T 43T	p6	0 -25	25T 25L	h6	-14 -39	11T 39L	g6	-14 -39	11T 39L	g6	-43 -68	18L 68L	f6
180	200	-30 0	+60 +31	90T 31T	m6	+106 +77	136T 77T	r6	0 -29	30T 29L	h6	-15 -44	15T 44L	g6	-15 -44	15T 44L	g6	-50 -79	20L 79L	f6
200	225					+109 +80	139T 80T													
225	250					+113 +84	143T 84T													
250	280	-35 0	+66 +34	101T 34T	m6	+146 +94	181T 94T	r7	0 -32	35T 32L	h6	-17 -49	18T 49L	g6	-17 -49	18T 49L	g6	-56 -88	21L 88L	f6
280	315					+150 +98	185T 98T													
315	355	-40 0	+73 +37	113T 37T	m6	+165 +108	205T 108T	r7	0 -36	40T 36L	h6	-18 -75	22T 75L	g7	-18 -75	22T 75L	g7	— —	— —	— —
355	400					+171 +114	211T 114T													
400	450	-45 0	+80 +40	125T 40T	m6	+189 +126	234T 126T	r7	0 -40	45T 40L	h6	-20 -83	25T 83L	g7	-20 -83	25T 83L	g7	— —	— —	— —
450	500					+195 +132	240 132T													
500	630	-50 0	+100 +50	150T 50T	—	+200 +125	250T 125T	—	0 -50	50T 50L	—	-50 -100	0 100L	—	-50 -100	0 100L	—	— —	— —	— —
630	800	-80 0	+150 +50	205T 50T	—	+225 +150	305T 150T	—	0 -75	80T 75L	—	-80 -150	0 150L	—	-80 -150	0 150L	—	— —	— —	— —
800	1000	-100 0	+150 +50	250T 50T	—	+275 +175	375T 175T	—	0 -100	100T 100L	—	-100 -200	0 200L	—	-100 -200	0 200L	—	— —	— —	— —

CONE			Max Shaft Fillet Radii R <sup>**</sup>	Weight	CUP			Max Hs'ng Fillet Radii r <sup>**</sup>	Weight	BEAR-ING	Remarks
Number	BORE d	WIDTH B			Number	OUTSIDE DIA D	WIDTH C			WIDTH T	
<b>5A Series</b>											
					6						
					6CE	SEE STEERING GEAR BEARING SECTION					
					7						
					7A						
					06						
<b>5C Series</b>											
4A	19.050 .7500	11.908 .4688	1.5 .06	.06 kg .12 lb	*06	49.154 1.9352	15.875 .6250	.8 .03	.11 kg .24 lb	18.968 .7468	4CB: NO SMALL RIB
4C	17.462 .6875	11.908 .4688	1.5 .06	.06 kg .13 lb	6	44.450 1.7500	9.525 .3750	1.5 .06	.03 kg .08 lb	12.700 .5000	4CX: NO SMALL RIB
*4T	23.812 .9375	11.908 .4688	.8 .03	.05 kg .12 lb	*7A	49.154 1.9352	22.225 .8750	.8 .03	.15 kg .33 lb	25.382 .9993	4T: TAPERED BORE
					*7	49.154 1.9352	15.088 .5940	.4 .02	.10 kg .23 lb	18.262 .7190	06 : CHAMFER ON FRONTFACE OD
*4CB	20.638 .8125	12.090 .4760	1.3 .05	.05 kg .12 lb	4CB and grouped cones may be paired with all single cups corresponding to 4A and will require .537 mm (.0605 in) to be added to the T-width values.						7 : CHAMFER ON FRONTFACE OD
*4CX	19.588 .7712	12.090 .4760	.3 .01	.06 kg .12 lb							7A : SHOULDER ON OD BACKFACE
4X	19.588 .7712	13.444 .5293	.4 .01	.06 kg .14 lb							SPECIAL CHAMFER ON FRONTFACE OD
<b>11A Series</b>											
					13C						
					13X	SEE STEERING GEAR BEARING SECTION					
					14						
					14C						
					14CE						
					14XS						
<b>11C Series</b>											
*12CA	23.812 .9375	11.153 .4391	1.5 .06	.06 kg .14 lb	13X	49.609 1.9531	11.509 .4531	1.5 .06	.06 kg .13 lb	15.872 .6249	12CA: NO SMALL RIB
*12CB	25.400 1.0000	11.153 .4391	1.5 .06	.06 kg .13 lb	13C	49.225 1.9380	11.509 .4531	1.5 .06	.05 kg .12 lb	15.872 .6249	12CB: NO SMALL RIB
					*14	53.917 2.1227	16.172 .6367	.4 .02	.12 kg .27 lb	20.887 .8223	14 : CHAMFER ON BACKFACE OD
					*14C	57.092 2.2477	17.094 .6730	- -	.18 kg .39 lb	21.483 .8458	SPECIAL CHAMFER ON FRONTFACE OD
					*14XS	57.092 2.2477	17.094 .6730	2.0 .08	.18 kg .40 lb	21.483 .8458	14C : CHAMFER ON BACKFACE OD
					14CE	52.362 2.0615	9.525 .3750	1.5 .06	.06 kg .13 lb	13.091 .5154	SPECIAL CHAMFER ON FRONTFACE OD
<b>15A Series</b>											
					16						
					17	SEE STEERING GEAR BEARING SECTION					
					18						
<b>15C Series</b>											
					16						
					17	SEE STEERING GEAR BEARING SECTION					
					18						
<b>21A Series</b>											
					23	SEE STEERING GEAR BEARING SECTION					
					24						
<b>21C Series</b>											
					23	SEE STEERING GEAR BEARING SECTION					
					24						

\*\*These Maximum Fillet Radii will be cleared by the Cone or Cup Radii.  
†Bore or O.D. shown are maximum dimensions. \* See Remarks Column.

31A - 245 SERIES

2

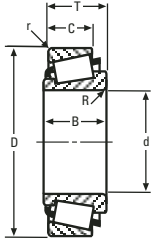

SINGLE ROW

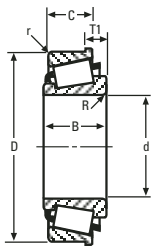

SINGLE ROW WITH FLANGE

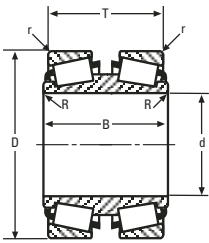

DOUBLE CONE

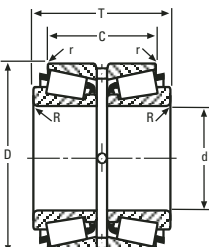

DOUBLE CUP

CONE				Weight	CUP				Weight	BEARING		Remarks
Number	BORE d	WIDTH B	Max Shaft Fillet Radii R <sup>**</sup>		Number	OUTSIDE DIA D	WIDTH C	Max Hs'ng Fillet Radii r <sup>**</sup>		WIDTH T		
<b>31A Series</b>												
*29	30.162 1.1875	16.662 .6560	1.5 .06	.13 kg .28 lb	32C	61.087 2.4050	11.908 .4688	1.5 .06	.08 kg .18 lb	19.054 .7502	29: NO SMALL RIB	
					32	61.087 2.4050	11.112 .4375	1.5 .06	.08 kg .18 lb	19.050 .7500		
					33	66.637 2.6235	11.112 .4375	1.5 .06	.13 kg .28 lb	19.050 .7500		
<b>31C Series</b>												
					32						SEE STEERING GEAR BEARING SECTION	
					32C							
					32X							
					33							
<b>35A Series</b>												
					36X						SEE STEERING GEAR BEARING SECTION	
					38A							
					38AW							
					38X							
<b>35C Series</b>												
*40	30.124 1.1860	15.479 .6094	1.3 .05	- -	36X	64.287 2.5310	13.096 .5156	1.5 .06	.10 kg .22 lb	18.273 .7194	40: NO SMALL RIB 38A : SPECIAL CHAMFER ON BACKFACE OD SPECIAL CHAMFER ON FRONTFACE OD 38AW : KEYWAY IN OD SURFACE SPECIAL CHAMFER ON BACKFACE OD SPECIAL CHAMFER ON FRONTFACE OD 38X : SPECIAL CHAMFER ON BACKFACE OD SPECIAL CHAMFER ON FRONTFACE OD	
					*38AW	69.850 2.7500	23.368 .9200	spcl. spcl.	.31 kg .69 lb	28.544 1.1238		
					*38X	69.850 2.7500	18.654 .7344	spcl. spcl.	.25 kg .56 lb	23.792 .9367		
					*38A	69.850 2.7500	23.368 .9200	spcl. spcl.	.32 kg .71 lb	28.544 1.1238		
<b>45 Series</b>												
					46						SEE STEERING GEAR BEARING SECTION	
					47							
					47W							
<b>U100 Series</b>												
U199	SEE UNIT BEARING SECTION				U160L	SEE UNIT BEARING SECTION						
<b>155 Series</b>												
157	20.000 .7874	16.205 .6380	1.0 .04	.11 kg .24 lb	153	52.000 2.0472	14.986 .5900	1.0 .04	.07 kg .15 lb	15.000 .5905		
<b>U200 Series</b>												
U298	SEE UNIT BEARING SECTION				U261L	SEE UNIT BEARING SECTION						
<b>235 Series</b>												
235	23.812 .9375	19.558 .7700	.8 .03	.16 kg .36 lb	233	62.000 2.4409	13.033 .5131	.8 .03	.10 kg .22 lb	17.000 .6693		
236	25.400 1.0000	19.558 .7700	.8 .03	.15 kg .34 lb	2320	56.896 2.2400	20.638 .8125	3.3 .13	.09 kg .20 lb	24.598 .9684		
237	25.000 .9843	19.558 .7700	.8 .03	.15 kg .34 lb	2330	56.896 2.2400	20.638 .8125	.8 .03	.10 kg .21 lb	24.598 .9684		
<b>245 Series</b>												
246X	22.225 .8750	19.000 .7480	3.5 .14	.19 kg .43 lb	242	62.000 2.4409	16.002 .6300	2.0 .08	.09 kg .21 lb	17.983 .7080		
0247	25.400 1.0000	19.000 .7480	2.0 .08	.18 kg .40 lb	243	62.000 2.4409	17.000 .6693	2.0 .08	.09 kg .21 lb	17.000 .6693		
247	25.000 .9843	19.000 .7480	2.0 .08	.18 kg .40 lb	244X	61.912 2.4375	17.462 .6875	3.3 .13	.10 kg .23 lb	21.018 .8275		
248X	20.622 .8119	19.000 .7480	2.0 .08	.21 kg .45 lb								

255 SERIES CONTINUED ON NEXT PAGE

\*\*These Maximum Fillet Radii will be cleared by the Cone or Cup Radii.  
†Bore or O.D. shown are maximum dimensions. \* See Remarks Column.

2

CONE				Max Shaft Fillet Radii R''	Weight	CUP			Max Hs'ng Fillet Radii r''	Weight	BEAR-ING	Remarks
Number	BORE d	WIDTH B				Number	OUTSIDE DIA D	WIDTH C				
<b>255 Series</b>												
255	31.750 1.2500	19.253 .7580	.23 .09	.21 kg .46 lb	0253	69.850 2.7500	17.462 .6875	2.0 .08	.13 kg .28 lb	17.462 .6875		
256	33.338 1.3125	19.253 .7580	.8 .03	.20 kg .44 lb	253	72.000 2.8346	17.000 .6693	.8 .03	.16 kg .35 lb	17.000 .6693		
257	30.162 1.1875	19.253 .7580	.8 .03	.22 kg .49 lb	2520	66.421 2.6150	20.638 .8125	3.3 .13	.12 kg .26 lb	24.606 .9687		
258	26.988 1.0625	19.253 .7580	.8 .03	.24 kg .54 lb	2523-S	69.850 2.7500	19.050 .7500	1.5 .06	.17 kg .37 lb	23.019 .9062		
259	35.000 1.3780	19.253 .7580	.8 .03	.18 kg .41 lb								
<b>U300 Series</b>												
U399	SEE UNIT BEARING SECTION				U360L	SEE UNIT BEARING SECTION						
U399A					U365L							
<b>315 Series</b>												
315	25.400 1.0000	22.174 .8730	.8 .03	.33 kg .74 lb	312	72.626 2.8593	23.812 .9375	3.3 .13	.19 kg .41 lb	26.988 1.0625		
316	30.162 1.1875	22.174 .8730	.8 .03	.30 kg .66 lb	313	72.000 2.8346	19.000 .7480	2.0 .08	.12 kg .26 lb	19.000 .7480		
319	30.000 1.1811	22.174 .8730	.8 .03	.30 kg .67 lb	314	80.000 3.1496	21.000 .8268	2.0 .08	.29 kg .64 lb	21.000 .8268		
320	22.225 .8750	22.174 .8730	.8 .03	.35 kg .78 lb	323	75.000 2.9528	19.000 .7480	2.0 .08	.17 kg .38 lb	19.000 .7480		
321	25.776 1.0148	22.174 .8730	.8 .03	.33 kg .72 lb								
322	29.972 1.1800	22.174 .8730	.8 .03	.30 kg .67 lb								
325	34.925 1.3750	22.174 .8730	.8 .03	.25 kg .56 lb								
<b>335 Series</b>												
334	30.162 1.1875	22.403 .8820	.8 .03	.43 kg .95 lb	332	80.000 3.1496	17.826 .7018	1.3 .05	.14 kg .32 lb	21.000 .8268		347X: EXTENDED LARGE RIB SHOULDER ON OD BACKFACE
V334A	25.000 .9842	21.151 .8327	1.5 .06	.45 kg 1.00 lb	332A	80.000 3.1496	21.000 .8268	2.3 .09	.18 kg .39 lb	24.175 .9518		332-B : FLANGE ON OD FRONTFACE, BEARING WIDTH IS T1 DIMENSION
335	34.925 1.3750	22.403 .8820	.8 .03	.39 kg .85 lb	*332-B	80.000 3.1496	17.826 .7018	.8 .03	.17 kg .37 lb	7.938 .3125		
335-S	33.338 1.3125	22.403 .8820	.8 .03	.40 kg .88 lb	332US	80.000 3.1496	17.826 .7018	2.0 .08	.14 kg .31 lb	21.000 .8268		
336	41.275 1.6250	22.403 .8820	.8 .03	.32 kg .70 lb	333	80.000 3.1496	21.000 .8268	2.0 .08	.16 kg .34 lb	21.000 .8268		
337	38.100 1.5000	22.403 .8820	.8 .03	.35 kg .78 lb	333A	79.974 3.1486	21.000 .8268	.8 .03	.16 kg .35 lb	21.000 .8268		
337W	38.100 1.5000	22.403 .8820	.8 .03	.34 kg .76 lb	V333AS	80.000 3.1496	21.000 .8268	1.5 .06	.16 kg .35 lb	21.000 .8268		
338	25.400 1.0000	22.403 .8820	.8 .03	.47 kg 1.03 lb	0332US	85.725 3.3750	17.826 .7018	2.3 .09	.24 kg .54 lb	21.000 .8268		
339	35.000 1.3780	22.403 .8820	.8 .03	.39 kg .85 lb	3320	80.167 3.1562	23.812 .9375	3.3 .13	.21 kg .46 lb	26.987 1.0625		
339X	35.000 1.3780	22.403 .8820	2.0 .08	.38 kg .85 lb	3320X	85.725 3.3750	23.812 .9375	3.3 .13	.30 kg .66 lb	21.000 .8268		
342	41.275 1.6250	22.403 .8820	3.5 .14	.31 kg .69 lb								
342-S	42.875 1.6880	22.403 .8820	3.5 .14	.29 kg .65 lb								
342-SW	42.875 1.6880	22.403 .8820	3.5 .14	.30 kg .66 lb								
342X	43.000 1.6929	22.403 .8820	3.5 .14	.30 kg .66 lb								
343	34.925 1.3750	22.403 .8820	3.5 .14	.38 kg .84 lb								
344	40.000 1.5748	22.403 .8820	3.5 .14	.33 kg .72 lb								
344A	40.000 1.5748	22.403 .8820	.8 .03	.33 kg .74 lb								
346	31.750 1.2500	22.403 .8820	.8 .03	.42 kg .92 lb								

\*\*These Maximum Fillet Radii will be cleared by the Cone or Cup Radii.  
†Bore or O.D. shown are maximum dimensions. \* See Remarks Column.

335 - 355 SERIES

2

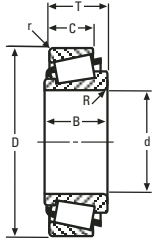

SINGLE ROW

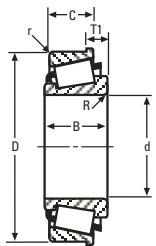

SINGLE ROW WITH FLANGE

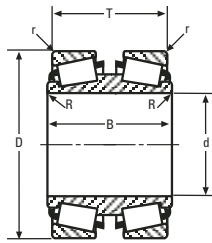

DOUBLE CONE

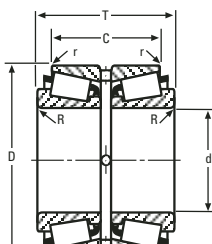

DOUBLE CUP

CONE			Max Shaft Fillet Radii R**	Weight	CUP			Max Hs'ng Fillet Radii r**	Weight	BEARING WIDTH T	Remarks
Number	BORE d	WIDTH B			Number	OUTSIDE DIA D	WIDTH C				
<b>335 Series (cont)</b>											
347	38.100 1.5000	22.403 .8820	3.5 .14								
337-S	38.100 1.5000	23.673 .9320	.8 .03	.37 kg .81 lb	337-S and grouped cones may be paired with all single cups corresponding to 334 and will require 1.270 mm (.0500 in) to be added to the T-width values.						
337X	40.483 1.5938	23.673 .9320	.8 .03	.34 kg .75 lb							
342A	41.275 1.6250	29.977 1.1802	3.5 .14	.39 kg .87 lb	342A may be paired with all single cups corresponding to 334 and will require 7.574 mm (.2982 in) to be added to the T-width values.						
*347X	35.710 1.4059	32.542 1.2812	5.0 .20	.48 kg 1.06 lb	347X may be paired with all single cups corresponding to 334 and will require 10.140 mm (.3992 in) to be added to the T-width values.						
<b>355 Series</b>											
350	40.000 1.5748	21.692 .8540	4.0 .16	.40 kg .88 lb	352	90.119 3.5480	21.808 .8586	2.3 .09	.32 kg .70 lb	23.000 .9055	359T: TAPERED BORE
350A	40.000 1.5748	21.692 .8540	.8 .03	.40 kg .89 lb	352A	88.875 3.4990	21.808 .8586	2.3 .09	.29 kg .63 lb	23.000 .9055	359TD: TAPERED BORE
355	44.450 1.7500	21.692 .8540	2.3 .09	.35 kg .78 lb	352X	90.000 3.5433	21.808 .8586	2.3 .09	.31 kg .69 lb	23.000 .9055	353D : GROOVE IN OD CENTER HOLES IN OD CENTER
355A	44.450 1.7500	21.692 .8540	.8 .03	.35 kg .78 lb	353	90.000 3.5433	23.000 .9055	2.0 .08	.33 kg .72 lb	23.000 .9055	353DC : HOLES IN OD CENTER
355X	44.450 1.7500	21.692 .8540	3.5 .14	.35 kg .77 lb	*353D	90.119 3.5480	44.450 1.7500	.8 .03	.67 kg 1.47 lb	50.795 1.9998	354-B : FLANGE ON OD FRONTFACE, BEARING WIDTH IS T1 DIMENSION
356	30.162 1.1875	21.692 .8540	.8 .03	.50 kg 1.10 lb	*353DC	90.119 3.5480	44.450 1.7500	.8 .03	.67 kg 1.47 lb	50.795 1.9998	354ED : GROOVE IN OD CENTER HOLES IN OD CENTER
357	40.000 1.5748	21.692 .8540	2.3 .09	.40 kg .89 lb	354	85.000 3.3465	19.000 .7480	2.0 .08	.15 kg .34 lb	19.000 .7480	
358	45.000 1.7717	21.692 .8540	1.5 .06	.35 kg .77 lb	354A	85.000 3.3465	17.462 .6875	1.3 .05	.16 kg .35 lb	20.635 .8124	
358A	45.000 1.7717	21.692 .8540	3.5 .14	.34 kg .75 lb	*354-B	85.000 3.3465	17.462 .6875	1.5 .06	.19 kg .42 lb	7.938 .3125	
358X	45.000 1.7717	21.692 .8540	2.0 .08	.35 kg .76 lb	*354ED	84.983 3.3458	44.450 1.7500	.8 .03	.43 kg .95 lb	50.795 1.9998	
359-S	46.038 1.8125	21.692 .8540	2.3 .09	.33 kg .73 lb	354X	85.000 3.3465	17.462 .6875	1.5 .06	.16 kg .36 lb	20.635 .8124	
359A	46.038 1.8125	21.692 .8540	3.5 .14	.33 kg .72 lb	3520	84.138 3.3125	23.812 .9375	3.3 .13	.22 kg .48 lb	26.992 1.0627	
*359T	46.038 1.8125	21.692 .8540	.8 .03	.34 kg .75 lb	3525	87.312 3.4375	23.812 .9375	3.3 .13	.30 kg .65 lb	26.992 1.0627	
357DW	42.862 1.6875	65.075 2.5620	.8 .03	1.07 kg 2.35 lb	352	90.119 3.5480	21.808 .8586	2.3 .09	.32 kg .70 lb	54.991 2.1650	
358D	42.862 1.6875	52.375 2.0620	1.5 .06	.98 kg 2.16 lb	352A	88.875 3.4990	21.808 .8586	2.3 .09	.29 kg .63 lb	54.991 2.1650	
*359TD	45.781 1.8024	52.375 2.0620	.8 .03	.94 kg 2.07 lb	352X	90.000 3.5433	21.808 .8586	2.3 .09	.31 kg .69 lb	54.991 2.1650	
					353	90.000 3.5433	23.000 .9055	2.0 .08	.33 kg .72 lb	54.991 2.1650	
					354	85.000 3.3465	19.000 .7480	2.0 .08	.15 kg .34 lb	46.990 1.8500	
					354A	85.000 3.3465	17.462 .6875	1.3 .05	.16 kg .35 lb	50.267 1.9790	
					354X	85.000 3.3465	17.462 .6875	1.5 .06	.16 kg .36 lb	50.267 1.9790	
					3520	84.138 3.3125	23.812 .9375	3.3 .13	.22 kg .48 lb	65.903 2.5946	
					3525	87.312 3.4375	23.812 .9375	3.3 .13	.30 kg .65 lb	65.903 2.5946	
NA357	40.000 1.5748	25.400 1.0000	1.5 .06	.88 kg 1.93 lb	*353D	90.119 3.5480	44.450 1.7500	.8 .03	.67 kg 1.47 lb	50.800 2.0000	
					*353DC	90.119 3.5480	44.450 1.7500	.8 .03	.67 kg 1.47 lb	50.800 2.0000	
					*354ED	84.983 3.3458	44.450 1.7500	.8 .03	.43 kg .95 lb	50.800 2.0000	

365 SERIES CONTINUED ON NEXT PAGE

\*\*These Maximum Fillet Radii will be cleared by the Cone or Cup Radii.  
†Bore or O.D. shown are maximum dimensions. \* See Remarks Column.



2

CONE			Max Shaft Fillet Radii R <sup>1</sup>	Weight	CUP			Max Hs'ng Fillet Radii r <sup>1</sup>	Weight	BEAR-ING	Remarks
Number	BORE d	WIDTH B			Number	OUTSIDE DIA D	WIDTH C			WIDTH T	
<b>365 Series</b>											
365	50.000 1.9685	22.225 .8750	2.0 .08	.35 kg .78 lb	362	90.000 3.5433	15.875 .6250	2.0 .08	.17 kg .38 lb	20.000 .7874	365DA: ASYMMETRICAL BEARING HOLES IN OD LEFTFACE
365-S	49.212 1.9375	22.225 .8750	.8 .03	.36 kg .80 lb	362A	88.900 3.5000	16.513 .6501	1.3 .05	.16 kg .36 lb	20.637 .8125	365DAA: ASYMMETRICAL BEARING HOLES IN OD LEFTFACE
365A	41.275 1.6250	22.225 .8750	3.5 .14	.46 kg 1.01 lb	*362AB	88.900 3.5000	16.513 .6501	1.3 .05	.19 kg .42 lb	8.887 .3499	365DE: EXTENDED SMALL RIB
366	50.000 1.9685	22.225 .8750	2.3 .09	.35 kg .78 lb	362AX	88.900 3.5000	19.688 .7751	1.3 .05	.21 kg .47 lb	23.812 .9375	365DEE: EXTENDED SMALL RIB
367	45.000 1.7717	22.225 .8750	2.0 .08	.42 kg .92 lb	*362-B	90.000 3.5433	15.875 .6250	.8 .03	.20 kg .44 lb	8.887 .3499	366DE: EXTENDED SMALL RIB
367X	44.988 1.7712	22.225 .8750	1.5 .06	.42 kg .92 lb	362X	90.000 3.5433	20.000 .7874	2.0 .08	.25 kg .55 lb	25.000 .9843	366DEE: EXTENDED SMALL RIB
*368	50.800 2.0000	22.225 .8750	1.5 .06	.34 kg .75 lb	362XD	89.985 3.5427	49.949 1.9665	.5 .02	.56 kg 1.24 lb	50.400 1.9843	367DA: ASYMMETRICAL BEARING HOLES IN OD LEFTFACE
368-S	51.592 2.0312	22.225 .8750	2.0 .08	.33 kg .73 lb	363	90.000 3.5433	20.000 .7874	.8 .03	.20 kg .45 lb	20.000 .7874	367DAA: ASYMMETRICAL BEARING HOLES IN OD LEFTFACE
368A	50.800 2.0000	22.225 .8750	3.5 .14	.33 kg .74 lb	*363D	90.000 3.5433	42.070 1.6563	.8 .03	.46 kg 1.01 lb	50.010 1.9689	367DAA: ASYMMETRICAL BEARING HOLES IN OD LEFTFACE
368W	50.800 2.0000	22.225 .8750	1.5 .06	.34 kg .75 lb	*363DC	90.000 3.5433	42.070 1.6563	.8 .03	.50 kg 1.10 lb	50.010 1.9689	367DE: EXTENDED SMALL RIB
369-S	47.625 1.8750	22.225 .8750	2.3 .09	.38 kg .85 lb	363X	88.900 3.5000	23.812 .9375	3.3 .13	.25 kg .56 lb	26.987 1.0625	367DEE: EXTENDED SMALL RIB
369A	47.625 1.8750	22.225 .8750	3.5 .14	.38 kg .84 lb	364XD	90.000 3.5433	42.862 1.6875	.8 .03	.51 kg 1.12 lb	50.802 2.0001	368: FRONTFACE CHAMFER
369AS	47.625 1.8750	22.225 .8750	2.3 .09	.38 kg .84 lb							368DA: ASYMMETRICAL BEARING HOLES IN OD LEFTFACE
370A	50.800 2.0000	22.225 .8750	5.0 .20	.33 kg .72 lb							368DAA: ASYMMETRICAL BEARING HOLES IN OD LEFTFACE
*365DA	44.450 1.7500	75.006 2.9530	.8 .03	1.28 kg 2.82 lb	362	90.000 3.5433	15.875 .6250	2.0 .08	.17 kg .38 lb	40.000 1.5748	
*365DAA	44.450 1.7500	75.006 2.9530	.8 .03	1.28 kg 2.82 lb	362A	88.900 3.5000	16.513 .6501	1.3 .05	.16 kg .36 lb	41.275 1.6250	368DE: EXTENDED SMALL RIB
*365DE	44.450 1.7500	88.900 3.5000	.8 .03	1.40 kg 3.08 lb	362AX	88.900 3.5000	19.688 .7751	1.3 .05	.21 kg .47 lb	47.625 1.8750	368DEE: EXTENDED SMALL RIB
*365DEE	44.450 1.7500	88.900 3.5000	.8 .03	1.40 kg 3.08 lb	362X	90.000 3.5433	20.000 .7874	2.0 .08	.25 kg .55 lb	50.002 1.9686	369DE: EXTENDED SMALL RIB
*366DE	47.625 1.8750	88.900 3.5000	.8 .03	1.24 kg 2.73 lb	363	90.000 3.5433	20.000 .7874	.8 .03	.20 kg .45 lb	40.000 1.5748	369DEE: EXTENDED SMALL RIB
*366DEE	47.625 1.8750	88.900 3.5000	.8 .03	1.24 kg 2.73 lb	363X	88.900 3.5000	23.812 .9375	3.3 .13	.25 kg .56 lb	53.975 2.1250	370DE: EXTENDED SMALL RIB
*367DA	49.212 1.9375	75.006 2.9530	.8 .03	1.08 kg 2.38 lb							370DEE: EXTENDED SMALL RIB
*367DAA	49.212 1.9375	75.006 2.9530	.8 .03	1.08 kg 2.38 lb							362-B : FLANGE ON OD FRONTFACE, BEARING WIDTH IS T1 DIMENSION
*367DE	49.212 1.9375	88.900 3.5000	.8 .03	1.16 kg 2.56 lb							362AB : FLANGE ON OD FRONTFACE, BEARING WIDTH IS T1 DIMENSION
*367DEE	49.212 1.9375	88.900 3.5000	.8 .03	1.16 kg 2.56 lb							363D : GROOVE IN OD CENTER HOLES IN OD CENTER
368D	50.800 2.0000	61.112 2.4060	.8 .03	.94 kg 2.08 lb							363DC : HOLES IN OD CENTER
*368DA	50.800 2.0000	75.006 2.9530	.8 .03	1.01 kg 2.23 lb							
*368DAA	50.800 2.0000	75.006 2.9530	.8 .03	1.01 kg 2.23 lb							
*368DE	50.800 2.0000	88.900 3.5000	.8 .03	1.08 kg 2.38 lb							
*368DEE	50.800 2.0000	88.900 3.5000	.8 .03	1.08 kg 2.38 lb							
*369DE	45.000 1.7717	88.900 3.5000	.8 .03	1.38 kg 3.03 lb							
*369DEE	45.000 1.7717	88.900 3.5000	.8 .03	1.38 kg 3.03 lb							
*370DE	50.000 1.9685	88.900 3.5000	.8 .03	1.12 kg 2.47 lb							

<sup>1</sup>These Maximum Fillet Radii will be cleared by the Cone or Cup Radii.  
<sup>†</sup>Bore or O.D. shown are maximum dimensions. \* See Remarks Column.

365 – 385 SERIES

2

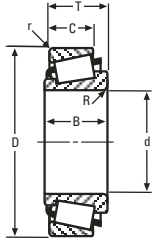

SINGLE ROW



SINGLE ROW WITH FLANGE

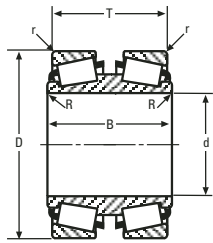

DOUBLE CONE

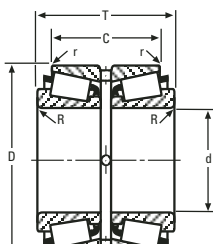

DOUBLE CUP

CONE				Max Shaft Fillet Radii R <sup>**</sup>	Weight	CUP			Max H's'ng Fillet Radii r <sup>**</sup>	Weight	BEARING WIDTH T	Remarks
Number	BORE d	WIDTH B				Number	OUTSIDE DIA D	WIDTH C				
<b>365 Series (cont)</b>												
*370DEE	50.000 1.9685	88.900 3.5000	.8 .03	1.12 kg 2.47 lb								
NA366	50.000 1.9685	25.006 .9845	3.5 .14	.72 kg 1.59 lb	362XD	89.985 3.5427	49.949 1.9665	.5 .02	.56 kg 1.24 lb	50.013 1.9690		
					*363D	90.000 3.5433	42.070 1.6563	.8 .03	.46 kg 1.01 lb	50.013 1.9690		
					*363DC	90.000 3.5433	42.070 1.6563	.8 .03	.50 kg 1.10 lb	50.013 1.9690		
					364XD	90.000 3.5433	42.862 1.6875	.8 .03	.51 kg 1.12 lb	50.013 1.9690		
<b>375 Series</b>												
375	50.800 2.0000	22.225 .8750	2.3 .09	.42 kg .92 lb	372	100.000 3.9370	21.824 .8592	2.0 .08	.43 kg .95 lb	25.000 .9842		377-S: FRONTFACE CHAMFER
375-S	50.800 2.0000	22.225 .8750	3.5 .14	.41 kg .91 lb	372A	96.838 3.8125	19.050 .7500	1.5 .06	.29 kg .64 lb	22.225 .8750		377TD: TAPERED BORE
375W	50.800 2.0000	22.225 .8750	.8 .03	.41 kg .89 lb	*372D	100.000 3.9370	39.690 1.5626	.8 .03	.76 kg 1.68 lb	50.800 2.0000		372D : GROOVE IN OD CENTER HOLES IN OD CENTER
376	45.000 1.7717	22.225 .8750	.8 .03	.50 kg 1.10 lb	372XD	100.000 3.9370	39.690 1.5626	.8 .03	.82 kg 1.80 lb	50.800 2.0000		
376A	45.000 1.7717	22.225 .8750	2.3 .09	.49 kg 1.09 lb	373	100.000 3.9370	25.000 .9842	2.0 .08	.47 kg 1.05 lb	24.998 .9842		
376X	45.000 1.7717	22.225 .8750	2.0 .08	.50 kg 1.09 lb	374	93.264 3.6718	15.083 .5938	1.3 .05	.17 kg .38 lb	20.637 .8125		
377	52.388 2.0625	22.225 .8750	2.3 .09	.40 kg .87 lb	3720	93.264 3.6718	23.812 .9375	3.3 .13	.28 kg .62 lb	26.988 1.0625		
*377-S	51.592 2.0312	22.225 .8750	1.5 .06	.41 kg .90 lb	3726	95.250 3.7500	23.812 .9375	3.3 .13	.34 kg .74 lb	26.988 1.0625		
377A	52.388 2.0625	22.225 .8750	4.8 .19	.38 kg .85 lb	3730	93.264 3.6718	23.812 .9375	.8 .03	.29 kg .65 lb	26.988 1.0625		
378A	49.987 1.9680	22.225 .8750	2.3 .09	.43 kg .95 lb								
380	52.388 2.0625	21.034 .8281	2.3 .09	.39 kg .85 lb								
375D	50.800 2.0000	53.188 2.0940	.8 .03	1.10 kg 2.43 lb	372	100.000 3.9370	21.824 .8592	2.0 .08	.43 kg .95 lb	58.735 2.3124		
375DW	50.800 2.0000	67.488 2.6570	.8 .03	1.20 kg 2.65 lb	372A	96.838 3.8125	19.050 .7500	1.5 .06	.29 kg .64 lb	53.188 2.0940		
376DE	47.625 1.8750	53.188 2.0940	.8 .03	1.22 kg 2.69 lb	373	100.000 3.9370	25.000 .9842	2.0 .08	.47 kg 1.05 lb	58.735 2.3124		
376DW	47.625 1.8750	67.488 2.6570	.8 .03	1.25 kg 2.76 lb	374	93.264 3.6718	15.083 .5938	1.3 .05	.17 kg .38 lb	50.013 1.9690		
*377TD	52.174 2.0541	53.188 2.0940	.8 .03	1.08 kg 2.39 lb	3720	93.264 3.6718	23.812 .9375	3.3 .13	.28 kg .62 lb	66.980 2.6370		
378DE	49.212 1.9375	53.188 2.0940	.8 .03	1.18 kg 2.59 lb	3726	95.250 3.7500	23.812 .9375	3.3 .13	.34 kg .74 lb	66.980 2.6370		
378DW	49.212 1.9375	67.488 2.6570	.8 .03	1.27 kg 2.79 lb	3730	93.264 3.6718	23.812 .9375	.8 .03	.29 kg .65 lb	66.980 2.6370		
<b>385 Series</b>												
385	55.000 2.1654	21.946 .8640	2.3 .09	.44 kg .97 lb	382	98.425 3.8750	17.826 .7018	.8 .03	.22 kg .49 lb	21.000 .8268		385-SD: EXTENDED SMALL RIB SQUARE BORE
385A	50.800 2.0000	21.946 .8640	2.3 .09	.50 kg 1.10 lb	382A	96.838 3.8125	15.875 .6250	.8 .03	.18 kg .39 lb	21.000 .8268		385DA: ASYMMETRICAL BEARING HOLES IN OD LEFTFACE
385AA	55.000 2.1654	21.946 .8640	2.3 .09	.44 kg .96 lb	*382-B	96.838 3.8125	17.826 .7018	- -	.22 kg .48 lb	7.938 .3125		NA385-SW: FRONTFACE CHAMFER SHOULDER ON OD BACKFACE SLOTS IN FRONTFACE
385AS	50.800 2.0000	21.946 .8640	1.5 .06	.50 kg 1.11 lb	382-S	96.838 3.8125	20.274 .7982	2.3 .09	.24 kg .53 lb	25.400 1.0000		
385AX	50.800 2.0000	21.946 .8640	.8 .03	.50 kg 1.11 lb	382X	96.838 3.8125	27.419 1.0795	2.3 .09	.38 kg .84 lb	32.545 1.2813		NA385-SWV: FRONTFACE CHAMFER MADE FROM VACUUM MELT STEEL SHOULDER ON OD BACKFACE SLOTS IN FRONTFACE
385X	55.000 2.1654	21.946 .8640	3.5 .14	.44 kg .96 lb	383	100.000 3.9370	21.000 .8268	2.0 .08	.28 kg .62 lb	21.000 .8268		
386	55.474 2.1840	21.946 .8640	2.3 .09	.43 kg .96 lb	383A	100.000 3.9370	17.826 .7018	2.0 .08	.25 kg .56 lb	21.000 .8268		

385 SERIES CONTINUED ON NEXT PAGE

\*\*These Maximum Fillet Radii will be cleared by the Cone or Cup Radii.  
†Bore or O.D. shown are maximum dimensions. \* See Remarks Column.

2

CONE			Max Shaft Fillet Radii R <sup>**</sup>	Weight	CUP			Max Hs'ng Fillet Radii r <sup>**</sup>	Weight	BEARING WIDTH T	Remarks
Number	BORE d	WIDTH B			Number	OUTSIDE DIA D	WIDTH C				
<b>385 Series (cont)</b>											
386A	47.625 1.8750	21.946 .8640	.8 .03	.55 kg 1.20 lb	383X	100.000 3.9370	22.225 .8750	1.3 .05	.35 kg .76 lb	25.400 1.0000	386DA: ASYMMETRICAL BEARING HOLES IN OD LEFTFACE
386AS	44.450 1.7500	21.946 .8640	3.5 .14	.58 kg 1.28 lb	*384D	100.000 3.9370	42.862 1.6875	.8 .03	.68 kg 1.49 lb	52.387 2.0625	NA386-SWV: FRONTFACE CHAMFER MADE FROM VACUUM MELT STEEL SHOULDER ON OD BACKFACE SLOTS IN FRONTFACE
386AX	47.625 1.8750	21.946 .8640	.8 .03	.54 kg 1.20 lb	*384DC	100.000 3.9370	42.862 1.6875	.8 .03	.68 kg 1.49 lb	52.387 2.0625	
387	57.150 2.2500	21.946 .8640	2.3 .09	.41 kg .90 lb	*384DRB	104.775 4.1250	39.675 1.5620	.8 .03	.82 kg 1.82 lb	49.200 1.9370	
387-S	57.150 2.2500	21.946 .8640	.8 .03	.41 kg .91 lb	*384ED	100.000 3.9370	39.675 1.5620	.8 .03	.59 kg 1.29 lb	49.200 1.9370	387DE: EXTENDED SMALL RIB
387A	57.150 2.2500	21.946 .8640	3.5 .14	.40 kg .89 lb	*384EDC	100.000 3.9370	39.675 1.5620	.8 .03	.59 kg 1.29 lb	49.200 1.9370	387DEE: EXTENDED SMALL RIB
387AS	57.150 2.2500	21.946 .8640	5.2 .20	.39 kg .86 lb	*384-SW	104.775 4.1250	22.225 .8750	.8 .03	.45 kg .99 lb	27.350 1.0768	388DA: ASYMMETRICAL BEARING HOLES IN OD LEFTFACE
387W	57.150 2.2500	21.946 .8640	2.3 .09	.41 kg .91 lb	384XD	100.000 3.9370	95.606 3.7640	.8 .03	1.69 kg 3.73 lb	105.130 4.1390	388DAA: ASYMMETRICAL BEARING HOLES IN OD LEFTFACE
388A	57.531 2.2650	21.946 .8640	3.5 .14	.40 kg .87 lb							388DE: EXTENDED SMALL RIB
388XS	57.981 2.2827	21.946 .8640	2.5 .10	.39 kg .87 lb							388DEE: EXTENDED SMALL RIB
389	55.575 2.1880	21.946 .8640	2.3 .09	.43 kg .95 lb							
389A	53.975 2.1250	21.946 .8640	.8 .03	.46 kg 1.01 lb							388TD: ASYMMETRICAL BEARING REVERSE TAPERED BORE
389AS	53.975 2.1250	21.946 .8640	1.5 .06	.46 kg 1.01 lb							382-B : FLANGE ON OD FRONTFACE, BEARING WIDTH IS T1 DIMENSION
389AW	53.975 2.1250	21.946 .8640	.8 .03	.46 kg 1.02 lb							384-SW : SHOULDER ON OD BACKFACE SLOTS IN BACKFACE
*NA385-SW	54.988 2.1649	26.035 1.0250	3.5 .14	.95 kg 2.09 lb	*384D	100.000 3.9370	42.862 1.6875	.8 .03	.68 kg 1.49 lb	52.070 2.0500	384D : GROOVE IN OD CENTER HOLES IN OD CENTER
*NA385-SWV	54.988 2.1649	26.035 1.0250	3.5 .14	.95 kg 2.09 lb	*384DC	100.000 3.9370	42.862 1.6875	.8 .03	.68 kg 1.49 lb	52.070 2.0500	384DC : HOLES IN OD CENTER
*NA386-SWV	54.988 2.1649	26.035 1.0250	3.5 .14	.93 kg 2.04 lb	*384DRB	104.775 4.1250	39.675 1.5620	.8 .03	.82 kg 1.82 lb	52.070 2.0500	384DRB : GROOVE IN OD RIGHTFACE HOLES IN OD CENTER
					*384ED	100.000 3.9370	39.675 1.5620	.8 .03	.59 kg 1.29 lb	52.070 2.0500	384ED : GROOVE IN OD CENTER HOLES IN OD CENTER
					*384EDC	100.000 3.9370	39.675 1.5620	.8 .03	.59 kg 1.29 lb	52.070 2.0500	384EDC : HOLES IN OD CENTER
					384XD	100.000 3.9370	95.606 3.7640	.8 .03	1.69 kg 3.73 lb	52.070 2.0500	384EDC : HOLES IN OD CENTER
					*K518331	119.987 4.7239	49.896 1.9644	spcl. spcl.	2.00 kg 4.42 lb	52.070 2.0500	K518331 : SPECIAL RADIUS ON LEFTFACE OD SPECIAL RADIUS ON RIGHTFACE OD
*387DE	55.000 2.1654	95.250 3.7500	.8 .03	1.50 kg 3.31 lb	382	98.425 3.8750	17.826 .7018	.8 .03	.22 kg .49 lb	42.062 1.6560	
*387DEE	55.000 2.1654	95.250 3.7500	.8 .03	1.51 kg 3.33 lb	382A	96.838 3.8125	15.875 .6250	.8 .03	.18 kg .39 lb	42.062 1.6560	
*388DA	55.562 2.1875	79.375 3.1250	.8 .03	1.35 kg 2.97 lb	382-S	96.838 3.8125	20.274 .7982	2.3 .09	.24 kg .53 lb	50.861 2.0024	
*388DAA	55.562 2.1875	79.375 3.1250	.8 .03	1.35 kg 2.97 lb	382X	96.838 3.8125	27.419 1.0795	2.3 .09	.38 kg .84 lb	65.151 2.5650	
*388DE	55.562 2.1875	95.250 3.7500	.8 .03	1.48 kg 3.26 lb	383	100.000 3.9370	21.000 .8268	2.0 .08	.28 kg .62 lb	42.062 1.6560	
*388DEE	55.562 2.1875	95.250 3.7500	.8 .03	1.48 kg 3.26 lb	383A	100.000 3.9370	17.826 .7018	2.0 .08	.25 kg .56 lb	42.062 1.6560	
					383X	100.000 3.9370	22.225 .8750	1.3 .05	.35 kg .76 lb	50.861 2.0024	
					*384-SW	104.775 4.1250	22.225 .8750	.8 .03	.45 kg .99 lb	54.762 2.1560	

\*\*These Maximum Fillet Radii will be cleared by the Cone or Cup Radii.  
†Bore or O.D. shown are maximum dimensions. \* See Remarks Column.

385 – 395 SERIES

2

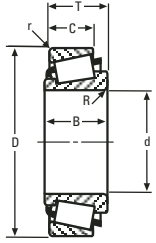

SINGLE ROW



SINGLE ROW WITH FLANGE

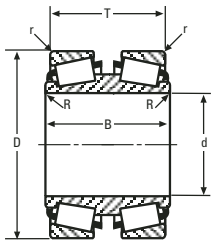

DOUBLE CONE

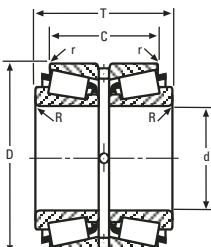

DOUBLE CUP

CONE				Weight	CUP			Weight	BEARING		Remarks
Number	BORE d	WIDTH B	Max Shaft Fillet Radii R**		Number	OUTSIDE DIA D	WIDTH C		Max Hs'ng Fillet Radii r**	WIDTH T	
<b>385 Series (cont)</b>											
*385-SD	51.308 2.0200	76.200 3.0000	- -	1.89 kg 4.17 lb	385-SD may be paired with all single cups corresponding to 387DE and will require 3.175 mm (.1250 in) to be added to the T-width values.						
*385DA	50.800 2.0000	85.555 3.3683	.8 .03	1.69 kg 3.72 lb	385DA and grouped cones may be paired with all single cups corresponding to 387DE and will require .008 mm (.0003 in) to be added to the T-width values.						
*386DA	49.212 1.9375	85.555 3.3683	.8 .03	1.77 kg 3.91 lb							
NA385	55.000 2.1654	26.192 1.0312	3.5 .14	.94 kg 2.08 lb	NA385 may be paired with all double cups corresponding to NA385-SW and will require .315 mm (.0124 in) to be added to the T-width values.						
*388TD	57.534 2.2651	53.188 2.0940	.7 .03	1.17 kg 2.59 lb	388TD and grouped cones may be paired with all single cups corresponding to 387DE and will require 9.235 mm (.3636 in) to be added to the T-width values.						
389DE	55.562 2.1875	53.188 2.0940	.8 .03	1.19 kg 2.63 lb							
389-S	55.575 2.1880	26.256 1.0337	2.3 .09	.47 kg 1.03 lb	382	98.425 3.8750	17.826 .7018	.8 .03	.22 kg .49 lb	20.886 .8223	
					382A	96.838 3.8125	15.875 .6250	.8 .03	.18 kg .39 lb	20.886 .8223	
					*382-B	96.838 3.8125	17.826 .7018	- -	.22 kg .48 lb	7.823 .3080	
					382-S	96.838 3.8125	20.274 .7982	2.3 .09	.24 kg .53 lb	25.285 .9955	
					382X	96.838 3.8125	27.419 1.0795	2.3 .09	.38 kg .84 lb	32.430 1.2768	
					383	100.000 3.9370	21.000 .8268	2.0 .08	.28 kg .62 lb	20.886 .8223	
					383A	100.000 3.9370	17.826 .7018	2.0 .08	.25 kg .56 lb	20.886 .8223	
					383X	100.000 3.9370	22.225 .8750	1.3 .05	.35 kg .76 lb	25.285 .9955	
					*384-SW	104.775 4.1250	22.225 .8750	.8 .03	.45 kg .99 lb	27.236 1.0723	
					384XD	100.000 3.9370	95.606 3.7640	.8 .03	1.69 kg 3.73 lb	104.900 4.1300	
<b>395 Series</b>											
390	57.150 2.2500	21.996 .8660	2.3 .09	- -	393	110.000 4.3307	27.000 1.0630	.8 .03	.39 kg .86 lb	27.000 1.0630	390DA: ASYMMETRICAL BEARING HOLES IN OD LEFTFACE
390A	63.500 2.5000	21.996 .8660	1.5 .06	- -	393A	112.712 4.4375	15.875 .6250	3.3 .13	.29 kg .64 lb	22.225 .8750	392DA: ASYMMETRICAL BEARING HOLES IN OD LEFTFACE
392	61.912 2.4375	21.996 .8660	.8 .03	- -	393AS	111.125 4.3750	18.824 .7411	1.3 .05	.29 kg .64 lb	22.000 .8661	395DA: ASYMMETRICAL BEARING HOLES IN OD LEFTFACE
395	63.500 2.5000	21.996 .8660	3.5 .14	- -	393C	113.487 4.4680	20.472 .8060	1.5 .06	.39 kg .86 lb	23.647 .9310	395TD: TAPERED BORE
395-S	66.675 2.6250	21.996 .8660	3.5 .14	- -	*393WE	116.586 4.5900	30.122 1.1859	.8 .03	.72 kg 1.58 lb	33.297 1.3109	399: FRONTFACE CHAMFER
395A	66.675 2.6250	21.996 .8660	.8 .03	- -	394	110.000 4.3307	22.000 .8661	.8 .03	.28 kg .62 lb	22.000 .8661	399AX: EXTENDED LARGE RIB SHOULDER ON OD BACKFACE
395X	63.500 2.5000	21.996 .8660	3.5 .14	- -	394A	110.000 4.3307	18.824 .7411	1.3 .05	.26 kg .58 lb	22.000 .8661	393WE: SLOTS IN BACKFACE
395XA	63.500 2.5000	21.996 .8660	7.0 .28	- -	*394AB	110.000 4.3307	18.824 .7411	1.3 .05	.30 kg .65 lb	7.925 .3120	394AB: FLANGE ON OD FRONTFACE, BEARING WIDTH IS T1 DIMENSION
396	50.000 1.9685	21.996 .8660	.8 .03	- -	*394ARB	110.000 4.3307	18.824 .7411	1.3 .05	.26 kg .58 lb	22.000 .8661	394ARB: GROOVE IN OD FRONTFACE
396-S	64.973 2.5580	21.996 .8660	3.5 .14	- -	394AS	110.000 4.3307	18.824 .7411	3.3 .13	.25 kg .55 lb	22.000 .8661	394D: GROOVE IN OD CENTER HOLES IN OD CENTER
396A	44.988 1.7712	21.996 .8660	3.5 .14	- -	394AX	110.000 4.3307	18.824 .7411	2.0 .08	- -	22.000 .8661	
397	60.000 2.3622	21.996 .8660	.8 .03	- -	394CS	113.487 4.4680	18.824 .7411	1.3 .05	.35 kg .77 lb	22.000 .8661	

395 SERIES CONTINUED ON NEXT PAGE

\*\*These Maximum Fillet Radii will be cleared by the Cone or Cup Radii.  
†Bore or O.D. shown are maximum dimensions. \* See Remarks Column.

2

CONE				Weight	CUP				Weight	BEAR-ING	Remarks
Number	BORE d	WIDTH B	Max Shaft Fillet Radii R <sup>**</sup>		Number	OUTSIDE DIA D	WIDTH C	Max Hs'ng Fillet Radii r <sup>**</sup>		WIDTH T	
395 Series (cont)											
397W	60.000 2.3622	21.996 .8660	.8 .03	-	*394D	110.000 4.3307	46.038 1.8125	.8 .03	.66 kg 1.46 lb	52.387 2.0625	394DA : HOLES IN OD CENTER SPECIAL RADIUS ON LEFTFACE OD
398	50.800 2.0000	21.996 .8660	.8 .03	-	*394DA	119.062 4.6875	46.038 1.8125	spcl. spcl.	1.02 kg 2.24 lb	52.387 2.0625	
*399	65.000 2.5591	21.996 .8660	2.0 .08	-	*394DC	110.000 4.3307	46.038 1.8125	.8 .03	.66 kg 1.46 lb	52.387 2.0625	394DC : HOLES IN OD CENTER
399A	68.262 2.6875	21.996 .8660	2.3 .09	-	394XS	109.985 4.3301	19.000 .7480	.5 .02	.28 kg .62 lb	23.749 .9350	394YD : HOLES IN OD CENTER
399AS	68.262 2.6875	21.996 .8660	5.0 .20	-	*394YD	110.000 4.3307	46.038 1.8125	.8 .03	.69 kg 1.53 lb	52.387 2.0625	3920-B : FLANGE ON OD FRONTFACE, BEARING WIDTH IS TI DIMENSION
					3920	112.712 4.4375	23.812 .9375	3.3 .13	.44 kg .98 lb	26.967 1.0617	K302664 : ASYMMETRICAL - TWO SERIES BEARING FLANGE ON OD RIGHTFACE
					*3920-B	112.712 4.4375	23.812 .9375	3.3 .13	.48 kg 1.06 lb	7.917 .3117	K426894 : ASYMMETRICAL - TWO SERIES BEARING FLANGE ON OD RIGHTFACE
					3921XA	109.985 4.3301	23.812 .9375	.5 .02	.36 kg .80 lb	26.555 1.0455	K529695 : ASYMMETRICAL - TWO SERIES BEARING FLANGE ON OD RIGHTFACE
390AC	63.500 2.5000	21.996 .8660	1.5 .06	1.16 kg 2.57 lb	*394D	110.000 4.3307	46.038 1.8125	.8 .03	.66 kg 1.46 lb	52.387 2.0625	
					*394DA	119.062 4.6875	46.038 1.8125	spcl. spcl.	1.02 kg 2.24 lb	52.387 2.0625	
					*394DC	110.000 4.3307	46.038 1.8125	.8 .03	.66 kg 1.46 lb	52.387 2.0625	
					*394YD	110.000 4.3307	46.038 1.8125	.8 .03	.69 kg 1.53 lb	52.387 2.0625	
*390DA	57.150 2.2500	86.952 3.4233	.8 .03	-	393	110.000 4.3307	27.000 1.0630	.8 .03	.39 kg .86 lb	55.248 2.1751	
*392DA	61.912 2.4375	86.952 3.4233	.8 .03	-	393A	112.712 4.4375	15.875 .6250	3.3 .13	.29 kg .64 lb	45.697 1.7991	
*395DA	63.500 2.5000	86.952 3.4233	.8 .03	-	393AS	111.125 4.3750	18.824 .7411	1.3 .05	.29 kg .64 lb	45.245 1.7813	
					393C	113.487 4.4680	20.472 .8060	1.5 .06	.39 kg .86 lb	48.542 1.9111	
					*393WE	116.586 4.5900	30.122 1.1859	.8 .03	.72 kg 1.58 lb	67.841 2.6709	
					394	110.000 4.3307	22.000 .8661	.8 .03	.28 kg .62 lb	45.245 1.7813	
					394A	110.000 4.3307	18.824 .7411	1.3 .05	.26 kg .58 lb	45.245 1.7813	
					*394ARB	110.000 4.3307	18.824 .7411	1.3 .05	.26 kg .58 lb	45.245 1.7813	
					394AS	110.000 4.3307	18.824 .7411	3.3 .13	.25 kg .55 lb	45.245 1.7813	
					394AX	110.000 4.3307	18.824 .7411	2.0 .08	- -	45.245 1.7813	
					394CS	113.487 4.4680	18.824 .7411	1.3 .05	.35 kg .77 lb	45.245 1.7813	
					394XS	109.985 4.3301	19.000 .7480	.5 .02	.28 kg .62 lb	48.745 1.9191	
					3920	112.712 4.4375	23.812 .9375	3.3 .13	.44 kg .98 lb	60.556 2.3841	
					3921XA	109.985 4.3301	23.812 .9375	.5 .02	.36 kg .80 lb	59.733 2.3517	
NA397	60.000 2.3622	26.192 1.0312	3.5 .14	1.40 kg 3.08 lb	*394D	110.000 4.3307	46.038 1.8125	.8 .03	.66 kg 1.46 lb	52.385 2.0624	
					*394DA	119.062 4.6875	46.038 1.8125	spcl. spcl.	1.02 kg 2.24 lb	52.385 2.0624	
					*394DC	110.000 4.3307	46.038 1.8125	.8 .03	.66 kg 1.46 lb	52.385 2.0624	
					*394YD	110.000 4.3307	46.038 1.8125	.8 .03	.69 kg 1.53 lb	52.385 2.0624	

\*\*These Maximum Fillet Radii will be cleared by the Cone or Cup Radii.  
†Bore or O.D. shown are maximum dimensions. \* See Remarks Column.

395 – 435 SERIES

2

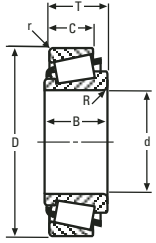

SINGLE ROW



SINGLE ROW WITH FLANGE

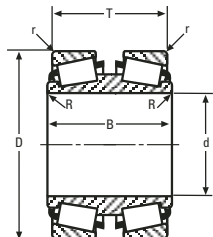

DOUBLE CONE

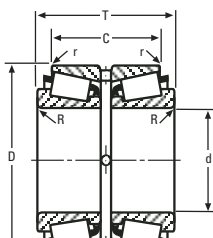

DOUBLE CUP

CONE				Weight	CUP			Max Hs'ng Fillet Radii r''	Weight	BEARING		Remarks
Number	BORE d	WIDTH B	Max Shaft Fillet Radii R''		Number	OUTSIDE DIA D	WIDTH C			WIDTH T		
<b>395 Series (cont)</b>												
					*K302664	124.396 4.8975	55.931 2.2020	- -	1.78 kg 3.93 lb	52.385 2.0624		
					*K426894	124.396 4.8975	58.738 2.3125	- -	2.07 kg 4.56 lb	52.385 2.0624		
					*K529695	124.396 4.8975	56.198 2.2125	- -	1.80 kg 3.96 lb	52.385 2.0624		
392DW	61.912 2.4375	73.025 2.8750	.8 .03	-	392DW and grouped cones may be paired with all single cups corresponding to 390DA and will require 10.305 mm (.4057 in) to be added to the T-width values.							
*395TD	64.971 2.5579	55.550 2.1870	.8 .03	-								
399D	61.912 2.4375	55.550 2.1870	.8 .03	-								
395CS	66.675 2.6250	23.444 .9230	3.5 .14	-	395CS may be paired with all single cups corresponding to 390 and will require 1.448 mm (.0570 in) to be added to the T-width values. 395CS may be paired with all double cups corresponding to 390 and will require 2.896 mm (.1140 in) to be added to the T-width values.							
*399AX	68.262 2.6875	36.347 1.4310	2.3 .09	-	399AX may be paired with all single cups corresponding to 390 and will require 14.351 mm (.5650 in) to be added to the T-width values. 399AX may be paired with all double cups corresponding to 390 and will require 28.702 mm (1.1300 in) to be added to the T-width values.							
<b>U400 Series</b>												
U497	SEE UNIT BEARING SECTION				U460L	SEE UNIT BEARING SECTION						
<b>415 Series</b>											413 : SHOULDER ON OD BACKFACE	
415	38.100 1.5000	29.083 1.1450	.8 .03	.50 kg 1.11 lb	412A	82.550 3.2500	23.812 .9375	1.5 .06	.21 kg .46 lb	28.575 1.1250		
416	30.000 1.1811	29.083 1.1450	.8 .03	.60 kg 1.33 lb	412	82.550 3.2500	30.162 1.1875	3.3 .13	.28 kg .63 lb	34.925 1.3750		
417	34.925 1.3750	29.083 1.1450	.8 .03	.54 kg 1.20 lb	413X	90.000 3.5433	22.000 .8661	2.0 .08	.36 kg .79 lb	26.012 1.0241		
418	38.100 1.5000	29.083 1.1450	3.5 .14	.50 kg 1.10 lb	*413	90.000 3.5433	26.162 1.0300	.8 .03	.37 kg .82 lb	26.161 1.0300		
419	41.275 1.6250	29.083 1.1450	3.5 .14	.45 kg 1.00 lb	414XA	90.000 3.5433	22.225 .8750	2.0 .08	.36 kg .79 lb	26.988 1.0625		
420	40.000 1.5748	29.083 1.1450	3.5 .14	.47 kg 1.04 lb	414X	88.900 3.5000	22.225 .8750	.8 .03	.34 kg .74 lb	26.988 1.0625		
421	35.000 1.3780	29.083 1.1450	.8 .03	.54 kg 1.20 lb	414A	88.500 3.4843	22.225 .8750	3.3 .13	.32 kg .70 lb	26.988 1.0625		
422	39.688 1.5625	29.083 1.1450	3.5 .14	.48 kg 1.05 lb	414	88.500 3.4843	22.225 .8750	1.5 .06	.33 kg .72 lb	26.988 1.0625		
<b>435 Series</b>												
435	44.450 1.7500	29.900 1.1772	.8 .03	.56 kg 1.24 lb	429XS	90.000 3.5433	25.400 1.0000	3.3 .13	.29 kg .64 lb	30.958 1.2188	NA435-SW: EXTENDED LARGE RIB FRONTFACE CHAMFER SLOTS IN FRONTFACE	
435-S	45.000 1.7717	29.900 1.1772	2.0 .08	.55 kg 1.21 lb	430X	90.000 3.5433	22.225 .8750	2.0 .08	.25 kg .54 lb	27.783 1.0938	438V: MADE FROM VACUUM MELT STEEL	
436	46.038 1.8125	29.900 1.1772	3.5 .14	.53 kg 1.17 lb	432	95.250 3.7500	22.225 .8750	2.3 .09	.38 kg .83 lb	27.783 1.0938	NA438-SW: FRONTFACE CHAMFER SLOTS IN FRONTFACE	
437	45.771 1.8020	29.900 1.1772	3.5 .14	.53 kg 1.18 lb	432A	95.250 3.7500	22.225 .8750	.8 .03	.38 kg .85 lb	27.783 1.0938	NA439-SW: EXTENDED LARGE RIB FRONTFACE CHAMFER SLOTS IN FRONTFACE	
438	44.450 1.7500	29.900 1.1772	3.5 .14	.55 kg 1.22 lb	*432AB	92.075 3.6250	22.225 .8750	2.3 .09	.33 kg .74 lb	11.115 .4376		
*438V	44.450 1.7500	29.900 1.1772	3.5 .14	.55 kg 1.22 lb	*432AV	95.250 3.7500	22.225 .8750	.8 .03	.38 kg .85 lb	27.783 1.0938	432-B : FLANGE ON OD FRONTFACE, BEARING WIDTH IS T1 DIMENSION	
438W	44.450 1.7500	29.900 1.1772	3.5 .14	.54 kg 1.20 lb	*432-B	95.250 3.7500	22.225 .8750	2.3 .09	.42 kg .92 lb	11.115 .4376	432AB : FLANGE ON OD FRONTFACE, BEARING WIDTH IS T1 DIMENSION	
439	41.275 1.6250	29.900 1.1772	1.3 .05	.61 kg 1.35 lb	*432D	95.250 3.7500	50.800 2.0000	.8 .03	.87 kg 1.93 lb	61.916 2.4376		
440	38.100 1.5000	29.900 1.1772	.8 .03	.66 kg 1.45 lb	*432DC	95.250 3.7500	50.800 2.0000	.8 .03	.87 kg 1.93 lb	61.916 2.4376	432AV : MADE FROM VACUUM MELT STEEL	
441	35.000 1.3780	29.900 1.1772	3.5 .14	.69 kg 1.53 lb	432X	95.250 3.7500	26.195 1.0313	3.3 .13	.46 kg 1.01 lb	31.753 1.2501	432D : GROOVE IN OD CENTER HOLES IN OD CENTER	

435 SERIES CONTINUED ON NEXT PAGE

\*\*These Maximum Fillet Radii will be cleared by the Cone or Cup Radii.  
†Bore or O.D. shown are maximum dimensions. \* See Remarks Column.

2

CONE			Max Shaft Fillet Radii R''	Weight	CUP			Max Hs'ng Fillet Radii r''	Weight	BEARING WIDTH T	Remarks
Number	BORE d	WIDTH B			Number	OUTSIDE DIA D	WIDTH C				
<b>435 Series (cont)</b>											
442-S	40.000 1.5748	29.900 1.1772	3.5 .14	.62 kg 1.38 lb	433	88.500 3.4843	30.162 1.1875	3.3 .13	.32 kg .72 lb	35.720 1.4063	432DC : HOLES IN OD CENTER T68976 : SPECIAL RADIUS ON LEFTFACE OD SPECIAL RADIUS ON RIGHTFACE OD K91179 : FLANGE ON OD LEFTFACE SPECIAL RADIUS ON LEFTFACE OD SPECIAL RADIUS ON RIGHTFACE OD TAPERED OD K326074 : FLANGE ON OD LEFTFACE SPECIAL RADIUS ON LEFTFACE OD
443	31.750 1.2500	29.900 1.1772	.8 .03	.74 kg 1.63 lb	4320	88.500 3.4843	33.338 1.3125	3.3 .13	.38 kg .83 lb	38.889 1.5310	
443W	31.750 1.2500	29.900 1.1772	.8 .03	.73 kg 1.60 lb	*T68976	120.650 4.7500	65.088 2.5625	spcl. spcl.	3.05 kg 6.73 lb	61.912 2.4375	
444	38.100 1.5000	29.900 1.1772	3.5 .14	.65 kg 1.44 lb							
445	28.575 1.1250	29.900 1.1772	.8 .03	.77 kg 1.71 lb							
447	41.275 1.6250	29.900 1.1772	3.5 .14	.61 kg 1.34 lb							
449	34.925 1.3750	29.900 1.1772	.8 .03	.70 kg 1.55 lb							
450	44.945 1.7695	29.900 1.1772	2.3 .09	.55 kg 1.22 lb							
NA438	44.450 1.7500	30.958 1.2188	3.5 .14	1.12 kg 2.48 lb	*432D	95.250 3.7500	50.800 2.0000	.8 .03	.87 kg 1.93 lb	61.915 2.4376	
*NA438-SW	44.450 1.7500	30.958 1.2188	3.5 .14	1.12 kg 2.47 lb	*432DC	95.250 3.7500	50.800 2.0000	.8 .03	.87 kg 1.93 lb	61.915 2.4376	
					K35666	127.000 5.0000	65.088 2.5625	3.3 .13	3.84 kg 8.47 lb	61.915 2.4376	
					K46688	120.000 4.7244	63.094 2.4840	3.3 .13	3.06 kg 6.75 lb	61.915 2.4376	
					*T68976	120.650 4.7500	65.088 2.5625	spcl. spcl.	3.05 kg 6.73 lb	61.915 2.4376	
					*K91179	127.000 5.0000	69.850 2.7500	spcl. spcl.	4.56 kg 10.04 lb	61.915 2.4376	
					*K326074	123.825 4.8750	69.850 2.7500	3.3 .13	4.53 kg 10.00 lb	61.915 2.4376	
*NA435-SW	44.450 1.7500	35.720 1.4063	3.5 .14	1.25 kg 2.76 lb	NA435-SW may be paired with all double cups corresponding to NA438 and will require 9.525 mm (.3750 in) to be added to the T-width values.						
*NA439-SW	44.450 1.7500	33.338 1.3125	.8 .03	1.19 kg 2.62 lb	NA439-SW may be paired with all double cups corresponding to NA438 and will require 4.760 mm (.1874 in) to be added to the T-width values.						
<b>455 Series</b>											
455	50.800 2.0000	29.317 1.1542	.8 .03	.81 kg 1.78 lb	452	107.950 4.2500	27.000 1.0630	.8 .03	.53 kg 1.16 lb	32.557 1.2818	NA455-SW: FRONTFACE CHAMFER SLOTS IN FRONTFACE
455-S	50.800 2.0000	29.317 1.1542	3.5 .14	.80 kg 1.76 lb	452A	107.950 4.2500	27.000 1.0630	3.3 .13	.53 kg 1.17 lb	32.557 1.2818	NA456-SW: EXTENDED LARGE RIB FRONTFACE CHAMFER SLOTS IN FRONTFACE
455A	38.100 1.5000	29.317 1.1542	3.5 .14	1.01 kg 2.22 lb	*452-B	107.950 4.2500	28.575 1.1250	.8 .03	.53 kg 1.17 lb	3.178 .1251	452-B : FLANGE ON OD FRONTFACE, BEARING WIDTH IS T1
455W	50.800 2.0000	29.317 1.1542	.8 .03	.78 kg 1.72 lb	*452D	107.950 4.2500	53.975 2.1250	.8 .03	1.09 kg 2.40 lb	65.089 2.5626	452D : GROOVE IN OD CENTER HOLES IN OD CENTER
456	53.975 2.1250	29.317 1.1542	3.5 .14	.74 kg 1.63 lb	*452DC	107.950 4.2500	53.975 2.1250	.8 .03	1.09 kg 2.40 lb	65.089 2.5626	
456W	53.975 2.1250	29.317 1.1542	3.5 .14	.71 kg 1.58 lb	453	107.950 4.2500	27.000 1.0630	.8 .03	.48 kg 1.06 lb	27.795 1.0943	452DC : HOLES IN OD CENTER
457	39.688 1.5625	29.317 1.1542	1.3 .05	.99 kg 2.18 lb	453A	107.950 4.2500	22.225 .8750	.8 .03	.42 kg .93 lb	27.782 1.0938	453-B : FLANGE ON OD FRONTFACE, BEARING WIDTH IS T1
458	44.450 1.7500	29.317 1.1542	.8 .03	.92 kg 2.02 lb	453AS	107.950 4.2500	22.225 .8750	2.3 .09	.41 kg .92 lb	27.782 1.0938	453DW : GROOVE IN OD CENTER
458-S	45.000 1.7717	29.317 1.1542	2.3 .09	.91 kg 2.00 lb	*453-B	107.950 4.2500	22.225 .8750	.8 .03	.46 kg 1.01 lb	11.115 .4376	HOLES IN OD CENTER KEYWAY IN OD SURFACE
459	40.000 1.5748	29.317 1.1542	2.0 .08	.98 kg 2.17 lb	*453DW	114.300 4.5000	55.562 2.1875	.8 .03	1.49 kg 3.29 lb	66.677 2.6251	453XB : FLANGE ON OD FRONTFACE, BEARING WIDTH IS T1
460	44.450 1.7500	29.317 1.1542	3.5 .14	.91 kg 2.01 lb	453E	104.775 4.1250	26.988 1.0625	3.3 .13	.42 kg .92 lb	32.545 1.2813	454AB : FLANGE ON OD FRONTFACE, BEARING WIDTH IS T1
461	42.850 1.6870	29.317 1.1542	.8 .03	.94 kg 2.08 lb	453X	104.775 4.1250	24.605 .9687	3.3 .13	.37 kg .81 lb	30.162 1.1875	DIMENSION
462	57.150 2.2500	29.317 1.1542	2.3 .09	.68 kg 1.50 lb	*453XB	107.950 4.2500	24.605 .9687	.8 .03	.49 kg 1.08 lb	8.735 .3439	

\*\*These Maximum Fillet Radii will be cleared by the Cone or Cup Radii.  
†Bore or O.D. shown are maximum dimensions. \* See Remarks Column.

455 - 475 SERIES

2

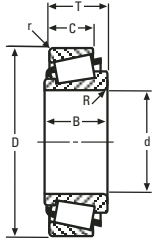

SINGLE ROW

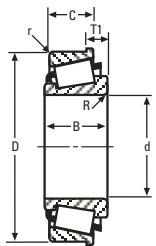

SINGLE ROW WITH FLANGE

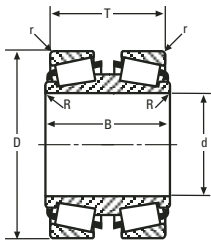

DOUBLE CONE

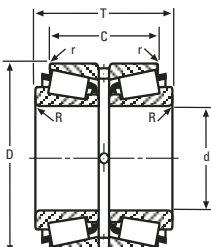

DOUBLE CUP

CONE			Max Shaft Fillet Radii R <sup>**</sup>	Weight	CUP			Max Hs'ng Fillet Radii r <sup>**</sup>	Weight	BEARING WIDTH T	Remarks
Number	BORE d	WIDTH B			Number	OUTSIDE DIA D	WIDTH C				
<b>455 Series (cont)</b>											
462A	57.150 2.2500	29.317 1.1542	2.3 .09	.67 kg 1.48 lb	454	110.000 4.3307	27.000 1.0630	2.0 .08	.55 kg 1.21 lb	27.795 1.0943	
462W	57.150 2.2500	29.317 1.1542	2.3 .09	.66 kg 1.45 lb	*454AB	109.949 4.3287	22.225 .8750	.8 .03	.55 kg 1.21 lb	11.115 .4376	
463	47.625 1.8750	29.317 1.1542	4.8 .19	.85 kg 1.87 lb	454X	109.949 4.3287	27.000 1.0630	1.5 .06	.55 kg 1.21 lb	27.795 1.0943	
464	41.275 1.6250	29.317 1.1542	2.3 .09	.96 kg 2.12 lb	4520	101.200 3.9843	33.338 1.3125	3.3 .13	.42 kg .93 lb	38.900 1.5315	
464A	41.275 1.6250	29.317 1.1542	1.5 .06	.96 kg 2.13 lb	4536	111.125 4.3750	32.545 1.2813	3.3 .13	.83 kg 1.82 lb	38.107 1.5003	
465	50.000 1.9685	29.317 1.1542	2.3 .09	.82 kg 1.81 lb							
466	54.988 2.1649	29.317 1.1542	2.3 .09	.72 kg 1.60 lb							
466-S	55.562 2.1875	29.317 1.1542	2.3 .09	.71 kg 1.57 lb							
467	47.625 1.8750	29.317 1.1542	.8 .03	.86 kg 1.91 lb							
468	52.388 2.0625	29.317 1.1542	1.5 .06	.76 kg 1.68 lb							
468W	52.388 2.0625	29.317 1.1542	1.5 .06	.76 kg 1.68 lb							
469	57.150 2.2500	29.317 1.1542	3.5 .14	.68 kg 1.49 lb							
469-S	57.150 2.2500	29.317 1.1542	4.8 .19	.67 kg 1.47 lb							
469A	57.150 2.2500	29.317 1.1542	3.5 .14	.67 kg 1.47 lb							
NA455	50.800 2.0000	32.545 1.2813	3.5 .14	1.69 kg 3.72 lb	*452D	107.950 4.2500	53.975 2.1250	.8 .03	1.09 kg 2.40 lb	65.090 2.5626	
*NA455-SW	50.800 2.0000	32.545 1.2813	3.5 .14	1.73 kg 3.81 lb	*452DC	107.950 4.2500	53.975 2.1250	.8 .03	1.09 kg 2.40 lb	65.090 2.5626	
					*453DW	114.300 4.5000	55.562 2.1875	.8 .03	1.49 kg 3.29 lb	65.090 2.5626	
*NA456-SW	50.800 2.0000	37.308 1.4688	3.5 .14	1.93 kg 4.26 lb	NA456-SW may be paired with all double cups corresponding to NA455 and will require 9.525 mm (.3750 in) to be added to the T-width values.						
<b>475 Series</b>											
475	55.000 2.1654	29.007 1.1420	.8 .03	1.16 kg 2.56 lb	472	120.000 4.7244	24.237 .9542	2.0 .08	.49 kg 1.07 lb	29.794 1.1730	482-SW: KEYWAY IN BACKFACE
475X	55.000 2.1654	29.007 1.1420	2.0 .08	1.16 kg 2.56 lb	472A	120.000 4.7244	23.444 .9230	3.3 .13	.46 kg 1.00 lb	29.002 1.1418	482E: SHOULDER ON ID BACKFACE
476	60.000 2.3622	29.007 1.1420	2.0 .08	1.06 kg 2.33 lb	*472-B	120.000 4.7244	24.237 .9542	.8 .03	.54 kg 1.18 lb	11.095 .4368	NA483-SW: EXTENDED LARGE RIB FRONTFACE CHAMFER SLOTS IN FRONTFACE
477	63.500 2.5000	29.007 1.1420	.8 .03	.98 kg 2.17 lb	*472D	120.000 4.7244	53.975 2.1250	.8 .03	1.21 kg 2.67 lb	65.090 2.5626	NA484-SW: FRONTFACE CHAMFER SLOTS IN FRONTFACE
478	65.000 2.5591	29.007 1.1420	2.3 .09	.94 kg 2.08 lb	*472DC	120.000 4.7244	53.975 2.1250	.8 .03	1.21 kg 2.67 lb	65.090 2.5626	
478-S	66.675 2.6250	29.007 1.1420	2.0 .08	.91 kg 2.00 lb	*472DS	127.000 5.0000	53.975 2.1250	.8 .03	1.80 kg 3.96 lb	65.090 2.5626	485T: TAPERED BORE
478W	65.000 2.5591	29.007 1.1420	2.3 .09	.93 kg 2.05 lb	472X	123.825 4.8750	24.605 .9687	3.3 .13	.63 kg 1.38 lb	30.162 1.1875	NA485-SW: EXTENDED LARGE RIB FRONTFACE CHAMFER SLOTS IN FRONTFACE
478XA	64.988 2.5586	29.007 1.1420	2.3 .09	.94 kg 2.08 lb	473	120.000 4.7244	29.000 1.1417	2.0 .08	.54 kg 1.18 lb	29.794 1.1730	
479	66.675 2.6250	29.007 1.1420	2.3 .09	.90 kg 1.99 lb	473XS	119.979 4.7236	27.193 1.0706	.5 .02	.58 kg 1.28 lb	32.751 1.2894	487TD: TAPERED BORE
480	68.262 2.6875	29.007 1.1420	3.5 .14	.86 kg 1.90 lb	474	130.000 5.1181	31.000 1.2205	2.0 .08	1.07 kg 2.36 lb	31.796 1.2518	472-B : FLANGE ON OD FRONTFACE, BEARING WIDTH IS T1 DIMENSION
482	69.850 2.7500	29.007 1.1420	3.5 .14	.82 kg 1.81 lb	474XS	120.000 4.7244	26.187 1.0310	2.0 .08	.54 kg 1.20 lb	31.796 1.2518	472D : GROOVE IN OD CENTER HOLES IN OD CENTER
*482-SW	69.850 2.7500	29.007 1.1420	3.5 .14	.80 kg 1.75 lb							472DC : HOLES IN OD CENTER
482A	69.850 2.7500	29.007 1.1420	4.8 .19	.81 kg 1.79 lb							472DS : HOLES IN OD CENTER

475 SERIES CONTINUED ON NEXT PAGE

\*\*These Maximum Fillet Radii will be cleared by the Cone or Cup Radii.  
†Bore or O.D. shown are maximum dimensions. \* See Remarks Column.



2

CONE			Max Shaft Fillet Radii R <sup>**</sup>	Weight	CUP			Max Hs'ng Fillet Radii r <sup>**</sup>	Weight	BEARING WIDTH T	Remarks
Number	BORE d	WIDTH B			Number	OUTSIDE DIA D	WIDTH C				
<b>475 Series (cont)</b>											
<b>482W</b>	69.850 2.7500	29.007 1.1420	3.5 .14	.80 kg 1.76 lb							K102084 : FLANGE ON OD LEFTFACE SPECIAL RADIUS ON LEFTFACE OD
<b>483</b>	63.500 2.5000	29.007 1.1420	3.5 .14	.97 kg 2.14 lb							SPECIAL RADIUS ON RIGHTFACE OD TAPERED OD
<b>484</b>	70.000 2.7559	29.007 1.1420	2.0 .08	.82 kg 1.82 lb							
<b>*485T</b>	72.255 2.8447	29.007 1.1420	3.5 .14	.77 kg 1.70 lb							K104052 : FLANGE ON OD LEFTFACE SPECIAL RADIUS ON LEFTFACE OD SPECIAL RADIUS ON RIGHTFACE OD
<b>NA476</b>	60.000 2.3622	32.545 1.2813	3.5 .14	2.23 kg 4.92 lb	<b>*472D</b>	120.000 4.7244	53.975 2.1250	.8 .03	1.21 kg 2.67 lb	65.090 2.5626	K109521 : FLANGE ON OD LEFTFACE SPECIAL RADIUS ON LEFTFACE OD
<b>NA482</b>	69.850 2.7500	32.545 1.2813	3.5 .14	1.72 kg 3.79 lb	<b>*472DC</b>	120.000 4.7244	53.975 2.1250	.8 .03	1.21 kg 2.67 lb	65.090 2.5626	SPECIAL RADIUS ON RIGHTFACE OD
<b>NA484</b>	70.000 2.7559	32.545 1.2813	3.5 .14	1.71 kg 3.77 lb	<b>*472DS</b>	127.000 5.0000	53.975 2.1250	.8 .03	1.80 kg 3.96 lb	65.090 2.5626	K109587 : ASYMMETRICAL - TWO SERIES BEARING SPECIAL RADIUS ON LEFTFACE OD
<b>*NA484-SW</b>	70.000 2.7559	32.545 1.2813	3.5 .14	1.69 kg 3.72 lb	<b>K88207</b>	158.750 6.2500	73.025 2.8750	3.3 .13	5.95 kg 13.13 lb	65.090 2.5626	SPECIAL RADIUS ON RIGHTFACE OD
					<b>K94495</b>	177.800 7.0000	73.025 2.8750	3.3 .13	8.84 kg 19.49 lb	65.090 2.5626	K302661 : SPECIAL RADIUS ON LEFTFACE OD
					<b>K100019</b>	149.225 5.8750	73.025 2.8750	3.3 .13	4.59 kg 10.12 lb	65.090 2.5626	SPECIAL RADIUS ON RIGHTFACE OD
					<b>*K102084</b>	203.200 8.0000	76.200 3.0000	spcl. spcl.	14.51 kg 32.00 lb	65.090 2.5626	
					<b>*K104052</b>	203.200 8.0000	76.200 3.0000	spcl. spcl.	14.51 kg 32.00 lb	65.090 2.5626	K312461 : FLANGE ON OD LEFTFACE SPECIAL RADIUS ON LEFTFACE OD
					<b>K104429</b>	177.800 7.0000	69.058 2.7188	3.3 .13	8.91 kg 19.65 lb	65.090 2.5626	SPECIAL RADIUS ON RIGHTFACE OD
					<b>K107168</b>	203.200 8.0000	76.200 3.0000	3.3 .13	13.76 kg 30.35 lb	65.090 2.5626	
					<b>*K109521</b>	228.600 9.0000	76.200 3.0000	spcl. spcl.	19.99 kg 44.08 lb	65.090 2.5626	
					<b>*K109587</b>	165.511 6.5162	71.438 2.8125	spcl. spcl.	5.01 kg 11.04 lb	65.090 2.5626	
					<b>*K302661</b>	203.200 8.0000	101.600 4.0000	spcl. spcl.	22.09 kg 48.71 lb	65.090 2.5626	
					<b>*K312461</b>	158.750 6.2500	73.025 2.8750	spcl. spcl.	6.39 kg 14.10 lb	65.090 2.5626	
					<b>K312489</b>	228.600 9.0000	76.200 3.0000	3.3 .13	19.18 kg 42.29 lb	65.090 2.5626	
					<b>K516771</b>	159.974 6.2982	73.025 2.8750	3.3 .13	6.17 kg 13.60 lb	65.090 2.5626	
					<b>K516772</b>	199.974 7.8730	76.200 3.0000	3.3 .13	13.12 kg 28.93 lb	65.090 2.5626	
					<b>K516776</b>	142.875 5.6250	73.025 2.8750	3.3 .13	3.85 kg 8.50 lb	65.090 2.5626	
<b>*487TD</b>	72.072 2.8375	67.539 2.6590	.8 .03	2.25 kg 4.95 lb	<b>472</b>	120.000 4.7244	24.237 .9542	2.0 .08	.49 kg 1.07 lb	69.040 2.7181	
					<b>472A</b>	120.000 4.7244	23.444 .9230	3.3 .13	.46 kg 1.00 lb	67.455 2.6557	
<b>482-S</b>	69.850 2.7500	32.609 1.2838	2.3 .09	.86 kg 1.91 lb	<b>472</b>	120.000 4.7244	24.237 .9542	2.0 .08	.49 kg 1.07 lb	29.680 1.1685	
					<b>472A</b>	120.000 4.7244	23.444 .9230	3.3 .13	.46 kg 1.00 lb	28.887 1.1373	
					<b>*472-B</b>	120.000 4.7244	24.237 .9542	.8 .03	.54 kg 1.18 lb	10.980 .4323	
					<b>472X</b>	123.825 4.8750	24.605 .9687	3.3 .13	.63 kg 1.38 lb	30.048 1.1830	
					<b>473</b>	120.000 4.7244	29.000 1.1417	2.0 .08	.54 kg 1.18 lb	29.680 1.1685	

\*\*These Maximum Fillet Radii will be cleared by the Cone or Cup Radii.  
†Bore or O.D. shown are maximum dimensions. \* See Remarks Column.

475 – 495 SERIES

2

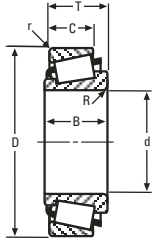

SINGLE ROW



SINGLE ROW WITH FLANGE

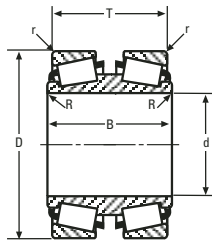

DOUBLE CONE

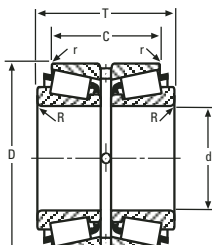

DOUBLE CUP

CONE			Max Shaft Fillet Radii R <sup>**</sup>	Weight	CUP			Max Hs'ng Fillet Radii r <sup>**</sup>	Weight	BEAR-ING	Remarks
Number	BORE d	WIDTH B			Number	OUTSIDE DIA D	WIDTH C			WIDTH T	
<b>475 Series (cont)</b>											
*482E	69.850 2.7500	45.964 1.8096	1.0 .04	1.21 kg 2.66 lb	473XS	119.979 4.7236	27.193 1.0706	.5 .02	.58 kg 1.28 lb	32.636 1.2849	482E may be paired with all single cups corresponding to 475 and will require 16.957 mm (.6676 in) to be added to the T-width values. 482E may be paired with all double cups corresponding to 475 and will require 33.914 mm (1.3352 in) to be added to the T-width values.
					474	130.000 5.1181	31.000 1.2205	2.0 .08	1.07 kg 2.36 lb	31.681 1.2473	
					474XS	120.000 4.7244	26.187 1.0310	2.0 .08	.54 kg 1.20 lb	31.682 1.2473	
					*NA483-SW	70.000 2.7559	37.308 1.4688	3.5 .14	1.91 kg 4.21 lb	NA483-SW and grouped cones may be paired with all double cups corresponding to NA476 and will require 9.525 mm (.3750 in) to be added to the T-width values.	
*NA485-SW	69.987 2.7554	37.308 1.4688	3.5 .14	1.96 kg 4.33 lb							
<b>495 Series</b>											
495	82.550 3.2500	29.769 1.1720	3.5 .14	1.07 kg 2.37 lb	492A	133.350 5.2500	22.225 .8750	3.3 .13	.42 kg .93 lb	30.163 1.1875	495DA: ASYMMETRICAL BEARING HOLES IN OD LEFTFACE
495-S	71.438 2.8125	29.769 1.1720	3.5 .14	1.39 kg 3.06 lb	*492W	133.350 5.2500	25.400 1.0000	3.3 .13	.50 kg 1.10 lb	33.338 1.3125	NA495-SW: FRONTFACE CHAMFER SLOTS IN FRONTFACE
495A	76.200 3.0000	29.769 1.1720	3.5 .14	1.26 kg 2.78 lb	493	136.525 5.3750	22.225 .8750	3.3 .13	.54 kg 1.18 lb	30.163 1.1875	496V: MADE FROM VACUUM MELT STEEL
495AA	66.675 2.6250	29.769 1.1720	3.5 .14	1.51 kg 3.33 lb	493A	134.976 5.3140	22.225 .8750	3.3 .13	.48 kg 1.06 lb	30.163 1.1875	497DA: ASYMMETRICAL BEARING HOLES IN OD LEFTFACE
495AS	77.788 3.0625	29.769 1.1720	3.5 .14	1.21 kg 2.68 lb	493AA	136.525 5.3750	22.225 .8750	.8 .03	.56 kg 1.23 lb	30.163 1.1875	
495AX	76.200 3.0000	29.769 1.1720	6.4 .25	1.23 kg 2.72 lb	*493-B	136.525 5.3750	22.225 .8750	3.3 .13	.60 kg 1.31 lb	13.475 .5305	NA497-SW: EXTENDED LARGE RIB FRONTFACE CHAMFER SLOTS IN FRONTFACE
495W	82.550 3.2500	29.769 1.1720	3.5 .14	1.07 kg 2.36 lb	*493D	136.525 5.3750	53.975 2.1250	.8 .03	1.39 kg 3.07 lb	69.850 2.7500	
495XA	82.550 3.2500	29.769 1.1720	7.0 .28	1.03 kg 2.28 lb	*493DC	136.525 5.3750	53.975 2.1250	.8 .03	1.39 kg 3.07 lb	69.850 2.7500	499T: TAPERED BORE
496	80.962 3.1875	29.769 1.1720	3.5 .14	1.12 kg 2.47 lb	*493DCA	136.525 5.3750	53.975 2.1250	.8 .03	1.43 kg 3.16 lb	69.850 2.7500	492W: SLOTS IN BACKFACE
496AS	81.700 3.2165	29.769 1.1720	3.5 .14	1.10 kg 2.42 lb	493P	136.525 5.3750	22.225 .8750	3.3 .13	.54 kg 1.18 lb	30.163 1.1875	493-B: FLANGE ON OD FRONTFACE, BEARING WIDTH IS T1 DIMENSION
496P	80.962 3.1875	29.769 1.1720	3.5 .14	1.12 kg 2.47 lb	493-S	136.525 5.3750	29.464 1.1600	3.3 .13	.62 kg 1.37 lb	30.163 1.1875	493D: GROOVE IN OD CENTER HOLES IN OD CENTER
*496V	80.962 3.1875	29.769 1.1720	3.5 .14	1.12 kg 2.47 lb	*493V	136.525 5.3750	22.225 .8750	3.3 .13	.54 kg 1.18 lb	30.163 1.1875	493DC: HOLES IN OD CENTER
496X	79.985 3.1490	29.769 1.1720	3.5 .14	1.15 kg 2.54 lb	493X	140.000 5.5118	22.225 .8750	3.0 .12	.67 kg 1.48 lb	30.163 1.1875	493DCA: HOLES IN OD CENTER
497	85.725 3.3750	29.769 1.1720	3.5 .14	.98 kg 2.15 lb	*494A	144.462 5.6875	22.225 .8750	1.5 .06	.82 kg 1.80 lb	30.163 1.1875	493V: MADE FROM VACUUM MELT STEEL
497A	85.725 3.3750	29.769 1.1720	6.4 .25	.95 kg 2.08 lb	*494-B	140.000 5.5118	22.225 .8750	3.0 .12	.75 kg 1.65 lb	13.495 .5313	494-B: FLANGE ON OD FRONTFACE, BEARING WIDTH IS T1 DIMENSION
497P	85.725 3.3750	29.769 1.1720	3.5 .14	.98 kg 2.15 lb	*494DC	139.974 5.5108	53.975 2.1250	.8 .03	1.71 kg 3.77 lb	69.850 2.7500	494A: SHOULDER ON OD BACKFACE
497W	85.725 3.3750	29.769 1.1720	3.5 .14	.96 kg 2.13 lb							494DC: HOLES IN OD CENTER
497X	75.000 2.9528	29.769 1.1720	3.0 .12	1.30 kg 2.86 lb							K312463: FLANGE ON OD LEFTFACE
498	84.138 3.3125	29.769 1.1720	3.5 .14	1.03 kg 2.26 lb							K312471: ASYMMETRICAL BEARING FLANGE ON OD LEFTFACE SPECIAL RADIUS ON LEFTFACE OD
498W	84.138 3.3125	29.769 1.1720	3.5 .14	1.02 kg 2.25 lb							SPECIAL RADIUS ON RIGHTFACE OD
499A	84.976 3.3455	29.769 1.1720	3.5 .14	1.00 kg 2.20 lb							
*499T	87.490 3.4445	29.769 1.1720	.8 .03	1.00 kg 2.20 lb							K326071: FLANGE ON OD LEFTFACE SPECIAL RADIUS ON LEFTFACE OD SPECIAL RADIUS ON RIGHTFACE OD

495 SERIES CONTINUED ON NEXT PAGE

\*\*These Maximum Fillet Radii will be cleared by the Cone or Cup Radii.  
†Bore or O.D. shown are maximum dimensions. \* See Remarks Column.

CONE			Max Shaft Fillet Radii R <sup>**</sup>	Weight	CUP			Max Hs'ng Fillet Radii r <sup>**</sup>	Weight	BEARING	Remarks
Number	BORE d	WIDTH B			Number	OUTSIDE DIA D	WIDTH C			WIDTH T	
<b>495 Series (cont)</b>											
*495DA	76.200 3.0000	106.477 4.1920	.8 .03	4.04 kg 8.90 lb	492A	133.350 5.2500	22.225 .8750	3.3 .13	.42 kg .93 lb	57.150 2.2500	
*497DA	80.962 3.1875	106.477 4.1920	.8 .03	3.53 kg 7.78 lb	*492W	133.350 5.2500	25.400 1.0000	3.3 .13	.50 kg 1.10 lb	63.500 2.5000	
					493	136.525 5.3750	22.225 .8750	3.3 .13	.54 kg 1.18 lb	57.150 2.2500	
					493A	134.976 5.3140	22.225 .8750	3.3 .13	.48 kg 1.06 lb	57.150 2.2500	
					493AA	136.525 5.3750	22.225 .8750	.8 .03	.56 kg 1.23 lb	57.150 2.2500	
					493P	136.525 5.3750	22.225 .8750	3.3 .13	.54 kg 1.18 lb	57.150 2.2500	
					*493V	136.525 5.3750	22.225 .8750	3.3 .13	.54 kg 1.18 lb	57.150 2.2500	
					493X	140.000 5.5118	22.225 .8750	3.0 .12	.67 kg 1.48 lb	57.150 2.2500	
					*494A	144.462 5.6875	22.225 .8750	1.5 .06	.82 kg 1.80 lb	57.150 2.2500	
*NA495-SW	76.200 3.0000	34.925 1.3750	3.5 .14	2.68 kg 5.91 lb	*493D	136.525 5.3750	53.975 2.1250	.8 .03	1.39 kg 3.07 lb	69.850 2.7500	
NA495A	76.200 3.0000	34.925 1.3750	3.5 .14	2.74 kg 6.05 lb	*493DC	136.525 5.3750	53.975 2.1250	.8 .03	1.39 kg 3.07 lb	69.850 2.7500	
					*493DCA	136.525 5.3750	53.975 2.1250	.8 .03	1.43 kg 3.16 lb	69.850 2.7500	
					*494DC	139.974 5.5108	53.975 2.1250	.8 .03	1.71 kg 3.77 lb	69.850 2.7500	
					K109597	158.750 6.2500	71.435 2.8124	1.5 .06	4.49 kg 9.90 lb	69.850 2.7500	
					K312462	203.200 8.0000	71.435 2.8124	1.5 .06	11.51 kg 25.38 lb	69.850 2.7500	
					*K312463	203.200 8.0000	71.435 2.8124	1.5 .06	12.20 kg 26.89 lb	69.850 2.7500	
					*K312471	203.200 8.0000	93.662 3.6875	spcl. spcl.	14.77 kg 32.56 lb	69.850 2.7500	
					*K326071	158.750 6.2500	71.435 2.8124	spcl. spcl.	5.02 kg 11.06 lb	69.850 2.7500	
496D	80.962 3.1875	59.538 2.3440	1.5 .06	2.70 kg 5.95 lb	492A	133.350 5.2500	22.225 .8750	3.3 .13	.42 kg .93 lb	60.325 2.3750	
496DA	81.700 3.2165	59.538 2.3440	2.0 .08	2.65 kg 5.85 lb	*492W	133.350 5.2500	25.400 1.0000	3.3 .13	.50 kg 1.10 lb	66.675 2.6250	
					493	136.525 5.3750	22.225 .8750	3.3 .13	.54 kg 1.18 lb	60.325 2.3750	
					493A	134.976 5.3140	22.225 .8750	3.3 .13	.48 kg 1.06 lb	60.325 2.3750	
					493AA	136.525 5.3750	22.225 .8750	.8 .03	.56 kg 1.23 lb	60.325 2.3750	
					493P	136.525 5.3750	22.225 .8750	3.3 .13	.54 kg 1.18 lb	60.325 2.3750	
					493-S	136.525 5.3750	29.464 1.1600	3.3 .13	.62 kg 1.37 lb	60.325 2.3750	
					*493V	136.525 5.3750	22.225 .8750	3.3 .13	.54 kg 1.18 lb	60.325 2.3750	
					493X	140.000 5.5118	22.225 .8750	3.0 .12	.67 kg 1.48 lb	60.325 2.3750	
					*494A	144.462 5.6875	22.225 .8750	1.5 .06	.82 kg 1.80 lb	60.325 2.3750	
*NA497-SW	85.725 3.3750	36.512 1.4375	3.5 .14	2.16 kg 4.77 lb	NA497-SW may be paired with all double cups corresponding to NA495-SW and will require 3.175 mm (.1250 in) to be added to the T-width values.						
498D	84.138 3.3125	75.413 2.9690	.8 .03	3.01 kg 6.63 lb	498D may be paired with all single cups corresponding to 496D and will require 15.875 mm (.6250 in) to be added to the T-width values.						

\*\*These Maximum Fillet Radii will be cleared by the Cone or Cup Radii.  
†Bore or O.D. shown are maximum dimensions. \* See Remarks Column.

525 – 535 SERIES

2

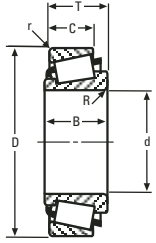

SINGLE ROW



SINGLE ROW WITH FLANGE

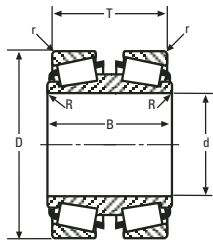

DOUBLE CONE

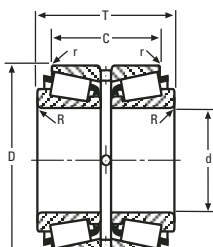

DOUBLE CUP

CONE			Max Shaft Fillet Radii R**	Weight	CUP			Max H's'ng Fillet Radii r**	Weight	BEARING WIDTH T	Remarks
Number	BORE d	WIDTH B			Number	OUTSIDE DIA D	WIDTH C				
<b>525 Series</b>											
525	38.100 1.5000	36.068 1.4200	3.5 .14	1.07 kg 2.36 lb	520X 100.000 3.9370	26.988 1.0625	3.3 .13	.35 kg .78 lb	34.925 1.3750	527AS: EXTENDED SMALL RIB	
525A	39.688 1.5625	36.068 1.4200	3.5 .14	1.04 kg 2.30 lb	tJ520 100.000 3.9370	26.988 1.0625	3.3 .13	.37 kg .81 lb	34.925 1.3750	V527A: EXTENDED LARGE RIB	
525X	38.100 1.5000	36.068 1.4200	.8 .03	1.08 kg 2.37 lb	522 101.600 4.0000	26.988 1.0625	3.3 .13	.41 kg .90 lb	34.925 1.3750	522-B: FLANGE ON OD FRONTFACE, BEARING WIDTH IS T1 DIMENSION	
526	41.275 1.6250	36.068 1.4200	3.5 .14	1.01 kg 2.24 lb	522A 100.038 3.9385	31.750 1.2500	4.3 .17	.44 kg .97 lb	39.688 1.5625	SPECIAL RADIUS ON BACKFACE OD	
526A	41.275 1.6250	36.068 1.4200	.8 .03	1.02 kg 2.25 lb	*522-B 101.600 4.0000	26.988 1.0625	spcl. spcl.	.47 kg 1.03 lb	14.288 .5625		
527	44.450 1.7500	36.068 1.4200	3.5 .14	.95 kg 2.10 lb	522X 101.200 3.9843	26.988 1.0625	3.3 .13	.39 kg .87 lb	34.925 1.3750		
527-S	44.983 1.7710	36.068 1.4200	4.3 .17	.94 kg 2.07 lb	V523 100.025 3.9380	27.927 1.0995	1.8 .07	.38 kg .84 lb	35.831 1.4107		
*527AS	44.450 1.7500	38.100 1.5000	3.5 .14	- -							
528	47.625 1.8750	36.068 1.4200	3.5 .14	.89 kg 1.96 lb							
528A	47.625 1.8750	36.068 1.4200	1.5 .06	.89 kg 1.97 lb							
528R	47.625 1.8750	36.068 1.4200	8.0 .31	.86 kg 1.89 lb							
529	50.800 2.0000	36.068 1.4200	.8 .03	.83 kg 1.82 lb							
529A	50.000 1.9685	36.068 1.4200	6.0 .24	.82 kg 1.81 lb							
529X	50.800 2.0000	36.068 1.4200	3.5 .14	.82 kg 1.80 lb							
*V527A	44.991 1.7713	39.688 1.5625	1.5 .06	1.02 kg 2.25 lb	V527A may be paired with all single cups corresponding to 525 and will require 3.620 mm (.1425 in) to be added to the T-width values.						
<b>535 Series</b>											
535	44.450 1.7500	36.957 1.4550	3.5 .14	1.09 kg 2.41 lb	532 111.125 4.3750	33.338 1.3125	3.3 .13	.79 kg 1.74 lb	38.100 1.5000	537X: KEYWAY IN ID	
536	47.625 1.8750	36.957 1.4550	3.5 .14	1.03 kg 2.27 lb	532A 111.125 4.3750	30.162 1.1875	3.3 .13	.74 kg 1.62 lb	38.100 1.5000	539T: TAPERED BORE	
537	50.800 2.0000	36.957 1.4550	3.5 .14	.96 kg 2.11 lb	*532-B 111.125 4.3750	30.162 1.1875	3.3 .13	.79 kg 1.75 lb	14.288 .5625	539W: KEYWAY IN ID	
*537X	50.800 2.0000	36.957 1.4550	3.5 .14	.97 kg 2.14 lb	532X 107.950 4.2500	28.575 1.1250	3.3 .13	.56 kg 1.24 lb	36.513 1.4375	532-B: FLANGE ON OD FRONTFACE, BEARING WIDTH IS T1 DIMENSION	
538	54.988 2.1649	36.957 1.4550	.8 .03	.86 kg 1.91 lb	532XA 109.949 4.3287	28.575 1.1250	3.3 .13	.64 kg 1.41 lb	36.513 1.4375	533D: GROOVE IN OD CENTER HOLES IN OD CENTER	
538US	54.988 2.1649	36.957 1.4550	3.5 .14	.86 kg 1.89 lb	533A 103.188 4.0625	30.162 1.1875	1.5 .06	.43 kg .95 lb	38.100 1.5000	533DC: HOLES IN OD CENTER	
539	53.975 2.1250	36.957 1.4550	3.5 .14	.88 kg 1.94 lb	*533D 111.125 4.3750	63.500 2.5000	1.5 .06	1.55 kg 3.41 lb	79.376 3.1250		
539A	53.975 2.1250	36.957 1.4550	5.5 .22	.87 kg 1.91 lb	*533DC 111.125 4.3750	63.500 2.5000	1.5 .06	1.55 kg 3.41 lb	79.376 3.1250		
*539T	53.975 2.1250	36.957 1.4550	3.5 .14	.92 kg 2.03 lb	533X 110.000 4.3307	30.162 1.1875	3.3 .13	.69 kg 1.52 lb	38.100 1.5000		
*539W	53.975 2.1250	36.957 1.4550	3.5 .14	.89 kg 1.96 lb	534 110.000 4.3307	26.988 1.0625	3.3 .13	.59 kg 1.30 lb	34.130 1.3437		
540	52.388 2.0625	36.957 1.4550	3.5 .14	.92 kg 2.03 lb							
54	41.275 1.6250	36.957 1.4550	3.5 .14	1.16 kg 2.55 lb							
542	38.100 1.5000	36.957 1.4550	3.5 .14	1.22 kg 2.68 lb							
543	40.000 1.5748	36.957 1.4550	3.5 .14	1.18 kg 2.60 lb							
543X	40.000 1.5748	36.957 1.4550	3.0 .12	1.18 kg 2.61 lb							
545	49.212 1.9375	36.957 1.4550	3.5 .14	.99 kg 2.19 lb							
546	49.982 1.9678	36.957 1.4550	3.5 .14	.98 kg 2.15 lb							

535 SERIES CONTINUED ON NEXT PAGE

\*\*These Maximum Fillet Radii will be cleared by the Cone or Cup Radii.  
†Bore or O.D. shown are maximum dimensions. \* See Remarks Column.

2

CONE			Max Shaft Fillet Radii R''	Weight	CUP			Max Hs'ng Fillet Radii r''	Weight	BEARING	Remarks
Number	BORE d	WIDTH B			Number	OUTSIDE DIA D	WIDTH C			WIDTH T	
<b>535 Series (cont)</b>											
NA539	53.975 2.1250	39.688 1.5625	3.5 .14	1.81 kg 3.98 lb	*533D	111.125 4.3750	63.500 2.5000	1.5 .06	1.55 kg 3.41 lb	79.375 3.1250	
					*533DC	111.125 4.3750	63.500 2.5000	1.5 .06	1.55 kg 3.41 lb	79.375 3.1250	
<b>555 Series</b>											
554	61.912 2.4375	36.678 1.4440	3.5 .14	1.27 kg 2.81 lb	552	123.825 4.8750	33.338 1.3125	3.3 .13	.80 kg 1.76 lb	38.100 1.5000	NA558: EXTENDED SMALL RIB
555	50.800 2.0000	36.678 1.4440	2.3 .09	1.56 kg 3.44 lb	552A	123.825 4.8750	30.162 1.1875	3.3 .13	.75 kg 1.65 lb	38.100 1.5000	NA558-SW: EXTENDED SMALL RIB FRONTFACE CHAMFER SLOTS IN FRONTFACE
555-S	57.150 2.2500	36.678 1.4440	3.5 .14	1.40 kg 3.09 lb	*552AW	123.825 4.8750	30.162 1.1875	3.3 .13	.76 kg 1.67 lb	38.100 1.5000	552-B: FLANGE ON OD FRONTFACE, BEARING WIDTH IS T1 DIMENSION
557	55.000 2.1654	36.678 1.4440	3.5 .14	1.46 kg 3.21 lb	552AX	123.825 4.8750	30.162 1.1875	.5 .02	.77 kg 1.69 lb	38.100 1.5000	552AW: KEYWAY BACKFACE
557-S	53.975 2.1250	36.678 1.4440	3.5 .14	1.48 kg 3.27 lb	*552-B	123.825 4.8750	30.162 1.1875	3.3 .13	.82 kg 1.81 lb	14.288 .5625	552D: GROOVE IN OD CENTER HOLES IN OD CENTER
557A	60.325 2.3750	36.678 1.4440	8.0 .31	1.28 kg 2.81 lb	*552D	123.825 4.8750	63.500 2.5000	1.5 .06	1.58 kg 3.49 lb	79.375 3.1250	
557X	53.975 2.1250	36.678 1.4440	3.5 .14	- -	*552DC	123.825 4.8750	63.500 2.5000	1.5 .06	1.58 kg 3.49 lb	79.375 3.1250	552DC: HOLES IN OD CENTER
558	60.325 2.3750	36.678 1.4440	2.3 .09	1.32 kg 2.92 lb	552-S	123.825 4.8750	26.975 1.0620	4.8 .19	.63 kg 1.38 lb	34.912 1.3745	553-BA: FLANGE ON OD FRONTFACE, BEARING WIDTH IS T1 DIMENSION
558-S	59.987 2.3617	36.678 1.4440	3.5 .14	1.33 kg 2.92 lb	552-SX	123.825 4.8750	31.750 1.2500	3.3 .13	.80 kg 1.77 lb	39.687 1.5625	553-SB: FLANGE ON OD FRONTFACE, BEARING WIDTH IS T1 DIMENSION
558A	60.325 2.3750	36.678 1.4440	3.5 .14	1.32 kg 2.90 lb	553A	125.000 4.9213	30.162 1.1875	3.3 .13	.80 kg 1.77 lb	38.100 1.5000	553X: GROOVE IN FRONTFACE
558X	60.000 2.3622	36.678 1.4440	3.0 .12	1.33 kg 2.93 lb	*553-BA	127.000 5.0000	34.925 1.3750	3.3 .13	.97 kg 2.13 lb	7.137 .2810	
559	63.500 2.5000	36.678 1.4440	3.5 .14	1.23 kg 2.71 lb	553-S	130.061 5.1205	30.162 1.1875	3.3 .13	1.04 kg 2.30 lb	38.100 1.5000	
559A	63.500 2.5000	36.678 1.4440	7.0 .28	1.20 kg 2.64 lb	553-SA	129.944 5.1159	30.162 1.1875	3.3 .13	1.04 kg 2.29 lb	38.100 1.5000	
560	66.675 2.6250	36.678 1.4440	3.5 .14	1.13 kg 2.50 lb	*553-SB	129.944 5.1159	30.162 1.1875	3.3 .13	1.13 kg 2.49 lb	14.288 .5625	
560-S	68.262 2.6875	36.678 1.4440	3.5 .14	1.09 kg 2.39 lb	*553X	122.238 4.8125	30.162 1.1875	3.3 .13	.68 kg 1.50 lb	38.100 1.5000	
*NA558	60.325 2.3750	39.688 1.5625	3.5 .14	2.73 kg 6.02 lb	*552D	123.825 4.8750	63.500 2.5000	1.5 .06	1.58 kg 3.49 lb	79.375 3.1250	
*NA558-SW	60.325 2.3750	39.688 1.5625	3.5 .14	2.76 kg 6.09 lb	*552DC	123.825 4.8750	63.500 2.5000	1.5 .06	1.58 kg 3.49 lb	79.375 3.1250	
<b>565 Series</b>											
565	63.500 2.5000	36.170 1.4240	3.5 .14	1.44 kg 3.18 lb	562	130.048 5.1200	28.575 1.1250	.8 .03	.80 kg 1.75 lb	36.512 1.4375	568T: TAPERED BORE
565-S	63.500 2.5000	36.170 1.4240	6.4 .25	1.42 kg 3.13 lb	*562DS	138.112 5.4375	65.088 2.5625	spcl. spcl.	2.60 kg 5.74 lb	80.962 3.1875	562DS: HOLES IN OD CENTER SPECIAL RADIUS ON LEFTFACE OD SPECIAL RADIUS ON RIGHTFACE OD
566	69.850 2.7500	36.170 1.4240	3.5 .14	1.25 kg 2.76 lb	562X	130.000 5.1181	29.000 1.1417	3.0 .12	.80 kg 1.75 lb	36.937 1.4542	563-B: FLANGE ON OD FRONTFACE, BEARING WIDTH IS T1 DIMENSION
566-S	69.850 2.7500	36.170 1.4240	.8 .03	1.26 kg 2.79 lb	563	127.000 5.0000	28.575 1.1250	3.3 .13	.64 kg 1.42 lb	36.512 1.4375	563D : GROOVE IN OD CENTER HOLES IN OD CENTER
566W	69.850 2.7500	36.170 1.4240	3.5 .14	1.24 kg 2.74 lb	563A	123.825 4.8750	28.575 1.1250	3.3 .13	.50 kg 1.11 lb	36.512 1.4375	563DC : HOLES IN OD CENTER
566X	69.850 2.7500	36.170 1.4240	6.8 .27	1.22 kg 2.70 lb	*563-B	127.000 5.0000	28.575 1.1250	3.3 .13	.72 kg 1.58 lb	14.288 .5625	
567	73.025 2.8750	36.170 1.4240	3.5 .14	1.15 kg 2.54 lb	*563D	127.000 5.0000	65.088 2.5625	1.5 .06	1.53 kg 3.38 lb	80.962 3.1875	564DW : GROOVE IN OD CENTER HOLES IN OD CENTER KEYWAY IN OD SURFACE
567-S	71.438 2.8125	36.170 1.4240	6.4 .25	1.18 kg 2.59 lb	*563DC	127.000 5.0000	65.088 2.5625	1.5 .06	1.53 kg 3.38 lb	80.962 3.1875	
567A	71.438 2.8125	36.170 1.4240	3.5 .14	1.20 kg 2.65 lb	563X	127.000 5.0000	28.575 1.1250	.8 .03	.66 kg 1.45 lb	36.512 1.4375	T61370 : ASYMMETRICAL BEARING BROKEN CORNER ON LEFTFACE OD CHAMFER ON RIGHTFACE OD
567AA	71.412 2.8115	36.170 1.4240	3.5 .14	1.21 kg 2.67 lb	564	131.762 5.1875	36.512 1.4375	3.3 .13	1.19 kg 2.63 lb	44.450 1.7500	
567W	73.025 2.8750	36.170 1.4240	3.5 .14	1.15 kg 2.53 lb	*564DW	133.350 5.2500	65.088 2.5625	.8 .03	2.07 kg 4.56 lb	80.962 3.1875	T64032A : BROKEN CORNER ON LEFTFACE OD CHAMFER ON RIGHTFACE OD
567X	73.025 2.8750	36.170 1.4240	4.8 .19	1.16 kg 2.55 lb	*T61370	127.000 5.0000	65.088 2.5625	- -	1.43 kg 3.15 lb	80.962 3.1875	

\*These Maximum Fillet Radii will be cleared by the Cone or Cup Radii.  
†Bore or O.D. shown are maximum dimensions. \* See Remarks Column.

565 – 575 SERIES

2

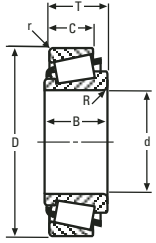

SINGLE ROW



SINGLE ROW WITH FLANGE

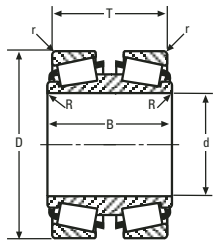

DOUBLE CONE

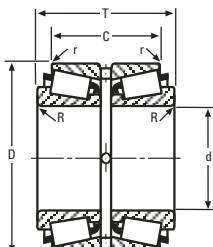

DOUBLE CUP

CONE			Max Shaft Fillet Radii R <sup>**</sup>	Weight	CUP			Max Hs'ng Fillet Radii r <sup>**</sup>	Weight	BEARING WIDTH T	Remarks
Number	BORE d	WIDTH B			Number	OUTSIDE DIA D	WIDTH C				
<b>565 Series (cont)</b>											
567XA	73.025 2.8750	36.170 1.4240	6.4 .25	1.15 kg 2.53 lb	*T64032A	127.000 5.0000	101.600 4.0000	-	2.76 kg 6.09 lb	117.475 4.6250	T78331 : ASYMMETRICAL BEARING BROKEN CORNER ON LEFTFACE OD BROKEN CORNER ON RIGHTFACE OD
568	73.817 2.9062	36.170 1.4240	.8 .03	1.14 kg 2.51 lb	*T78331	127.000 5.0000	65.088 2.5625	-	1.43 kg 3.15 lb	80.962 3.1875	
*568T	75.413 2.9690	36.170 1.4240	.8 .03	1.16 kg 2.55 lb							
568W	73.817 2.9062	36.170 1.4240	.8 .03	1.12 kg 2.46 lb							
568X	75.000 2.9528	36.170 1.4240	3.5 .14	1.09 kg 2.39 lb							
569	64.963 2.5576	36.170 1.4240	3.5 .14	1.40 kg 3.09 lb							
570	68.262 2.6875	36.170 1.4240	3.5 .14	1.30 kg 2.87 lb							
570X	70.000 2.7559	36.170 1.4240	3.0 .12	1.25 kg 2.76 lb							
NA567	73.025 2.8750	40.483 1.5938	6.8 .27	2.33 kg 5.14 lb	*562DS	138.112 5.4375	65.088 2.5625	spcl. spcl.	2.60 kg 5.74 lb	80.965 3.1876	
NA569	66.675 2.6250	40.483 1.5938	3.5 .14	2.84 kg 6.26 lb	*563D	127.000 5.0000	65.088 2.5625	1.5 .06	1.53 kg 3.38 lb	80.965 3.1876	
					*563DC	127.000 5.0000	65.088 2.5625	1.5 .06	1.53 kg 3.38 lb	80.965 3.1876	
					*564DW	133.350 5.2500	65.088 2.5625	.8 .03	2.07 kg 4.56 lb	80.965 3.1876	
					*T61370	127.000 5.0000	65.088 2.5625	-	1.43 kg 3.15 lb	80.965 3.1876	
					*T64032A	127.000 5.0000	101.600 4.0000	-	2.76 kg 6.09 lb	80.965 3.1876	
					*T78331	127.000 5.0000	65.088 2.5625	-	1.43 kg 3.15 lb	80.965 3.1876	
<b>575 Series</b>											
575	76.200 3.0000	36.098 1.4212	3.5 .14	1.60 kg 3.52 lb	572	139.992 5.5115	28.575 1.1250	3.3 .13	.77 kg 1.70 lb	36.513 1.4375	579TD : ASYMMETRICAL BEARING REVERSE TAPERED BORE
575-S	76.200 3.0000	36.098 1.4212	6.8 .27	1.56 kg 3.44 lb	572A	139.982 5.5111	28.575 1.1250	3.3 .13	.74 kg 1.64 lb	35.250 1.3878	580V : MADE FROM VACUUM MELT STEEL
575W	76.200 3.0000	36.098 1.4212	3.5 .14	1.61 kg 3.55 lb	*572AB	139.992 5.5115	28.575 1.1250	3.3 .13	.80 kg 1.77 lb	14.288 .5625	NA580-SW : EXTENDED LARGE RIB EXTENDED SMALL RIB
576	73.025 2.8750	36.098 1.4212	3.5 .14	1.70 kg 3.75 lb	*572-B	139.992 5.5115	28.575 1.1250	3.3 .13	.85 kg 1.88 lb	14.288 .5625	FRONTFACE CHAMFER SLOTS IN FRONTFACE
576W	73.025 2.8750	36.098 1.4212	3.5 .14	1.66 kg 3.67 lb	*572D	139.992 5.5115	66.675 2.6250	.8 .03	1.95 kg 4.29 lb	82.550 3.2500	572-B : FLANGE ON OD FRONTFACE, BEARING WIDTH IS T1 DIMENSION
577	74.612 2.9375	36.098 1.4212	3.5 .14	1.65 kg 3.64 lb	*572DC	139.992 5.5115	66.675 2.6250	.8 .03	1.95 kg 4.29 lb	82.550 3.2500	572AB : FLANGE ON OD FRONTFACE, BEARING WIDTH IS T1 DIMENSION
578	79.985 3.1490	36.098 1.4212	3.5 .14	1.46 kg 3.23 lb	572-S	139.700 5.5000	28.575 1.1250	.8 .03	.77 kg 1.71 lb	36.513 1.4375	572D : GROOVE IN OD CENTER HOLES IN OD CENTER
578W	79.992 3.1493	36.098 1.4212	3.5 .14	1.47 kg 3.24 lb	572X	139.700 5.5000	28.575 1.1250	3.3 .13	.76 kg 1.67 lb	36.513 1.4375	572DC : HOLES IN OD CENTER
578X	79.985 3.1490	36.098 1.4212	8.0 .31	1.41 kg 3.11 lb	572XS	139.700 5.5000	28.575 1.1250	4.8 .19	.74 kg 1.62 lb	36.513 1.4375	
580	82.550 3.2500	36.098 1.4212	3.5 .14	1.37 kg 3.02 lb	574	139.992 5.5115	28.575 1.1250	.5 .02	.79 kg 1.74 lb	36.513 1.4375	K100427 : CHAMFER ON LEFTFACE OD CHAMFER ON RIGHTFACE OD
*580V	82.550 3.2500	36.098 1.4212	3.5 .14	1.37 kg 3.02 lb							K104220 : CHAMFER ON LEFTFACE OD SPECIAL RADIUS ON RIGHTFACE OD TAPERED OD
580W	82.550 3.2500	36.098 1.4212	3.5 .14	1.37 kg 3.02 lb							
580WA	82.550 3.2500	36.098 1.4212	3.5 .14	1.37 kg 3.02 lb							
580X	82.550 3.2500	36.098 1.4212	4.8 .19	1.36 kg 3.00 lb							
581	80.962 3.1875	36.098 1.4212	3.5 .14	1.43 kg 3.15 lb							
581W	80.962 3.1875	36.098 1.4212	3.5 .14	1.44 kg 3.18 lb							
582	82.550 3.2500	36.098 1.4212	6.8 .27	1.33 kg 2.94 lb							

575 SERIES CONTINUED ON NEXT PAGE

\*\*These Maximum Fillet Radii will be cleared by the Cone or Cup Radii.  
†Bore or O.D. shown are maximum dimensions. \* See Remarks Column.

2

CONE			Max Shaft Fillet Radii R''	Weight	CUP			Max Hs'ng Fillet Radii r''	Weight	BEARING	Remarks
Number	BORE d	WIDTH B			Number	OUTSIDE DIA D	WIDTH C			WIDTH T	
<b>575 Series (cont)</b>											
*579TD	85.136 3.3518	80.134 3.1549	.8 .03	3.73 kg 8.23 lb	572	139.992 5.5115	28.575 1.1250	3.3 .13	.77 kg 1.70 lb	80.962 3.1875	
581D	80.962 3.1875	80.134 3.1549	1.5 .06	4.18 kg 9.22 lb	572A	139.982 5.5111	28.575 1.1250	3.3 .13	.74 kg 1.64 lb	78.438 3.0881	
					572-S	139.700 5.5000	28.575 1.1250	.8 .03	.77 kg 1.71 lb	80.962 3.1875	
					572X	139.700 5.5000	28.575 1.1250	3.3 .13	.76 kg 1.67 lb	80.962 3.1875	
					572XS	139.700 5.5000	28.575 1.1250	4.8 .19	.74 kg 1.62 lb	80.962 3.1875	
					574	139.992 5.5115	28.575 1.1250	.5 .02	.79 kg 1.74 lb	80.962 3.1875	
NA580	82.550 3.2500	41.275 1.6250	3.5 .14	2.89 kg 6.37 lb	*572D	139.992 5.5115	66.675 2.6250	.8 .03	1.95 kg 4.29 lb	82.550 3.2500	
					*572DC	139.992 5.5115	66.675 2.6250	.8 .03	1.95 kg 4.29 lb	82.550 3.2500	
					*K100427	192.966 7.5971	88.900 3.5000	-	5.41 kg 11.92 lb	82.550 3.2500	
					*K104220	171.450 6.7500	88.900 3.5000	spcl. spcl.	5.10 kg 11.25 lb	82.550 3.2500	
*NA580-SW	82.550 3.2500	46.038 1.8125	3.5 .14	2.98 kg 6.56 lb	NA580-SW may be paired with all double cups corresponding to NA580 and will require 9.525 mm (.3750 in) to be added to the T-width values.						
<b>595 Series</b>											
590	79.985 3.1490	36.322 1.4300	3.5 .14	2.04 kg 4.50 lb	592	152.400 6.0000	33.338 1.3125	3.3 .13	1.10 kg 2.42 lb	39.688 1.5625	NA593-SW: FRONTFACE CHAMFER SLOTS IN FRONTFACE
590A	76.200 3.0000	36.322 1.4300	3.5 .14	2.17 kg 4.79 lb	592A	152.400 6.0000	30.162 1.1875	3.3 .13	1.04 kg 2.29 lb	39.688 1.5625	594-SW: SLOTS IN BACKFACE
593	88.900 3.5000	36.322 1.4300	3.5 .14	1.70 kg 3.76 lb	592AS	152.400 6.0000	26.192 1.0312	.8 .03	.88 kg 1.93 lb	35.718 1.4062	NA596-SW: EXTENDED LARGE RIB FRONTFACE CHAMFER SLOTS IN FRONTFACE
593-S	89.090 3.5075	36.322 1.4300	3.5 .14	1.70 kg 3.74 lb	592AX	147.828 5.8200	26.192 1.0312	3.3 .13	.66 kg 1.45 lb	35.718 1.4062	592-B : FLANGE ON OD FRONTFACE, BEARING WIDTH IS T1 DIMENSION
593A	88.900 3.5000	36.322 1.4300	6.4 .25	1.67 kg 3.69 lb	*592-B	152.400 6.0000	30.162 1.1875	3.3 .13	1.13 kg 2.48 lb	15.875 .6250	592D : GROOVE IN OD CENTER HOLES IN OD CENTER
594	95.250 3.7500	36.322 1.4300	3.5 .14	1.44 kg 3.18 lb	*592D	152.400 6.0000	63.500 2.5000	.8 .03	2.29 kg 5.04 lb	82.550 3.2500	592DC : HOLES IN OD CENTER
*594-SW	95.250 3.7500	36.322 1.4300	3.5 .14	1.45 kg 3.20 lb	*592DC	152.400 6.0000	63.500 2.5000	.8 .03	2.29 kg 5.04 lb	82.550 3.2500	
594A	95.250 3.7500	36.322 1.4300	5.0 .20	1.43 kg 3.14 lb	592-S	152.400 6.0000	39.688 1.5625	3.3 .13	1.19 kg 2.62 lb	39.687 1.5625	K87718 : FLANGE ON OD LEFTFACE
594AA	95.250 3.7500	36.322 1.4300	.8 .03	1.46 kg 3.22 lb	592XE	147.638 5.8125	26.192 1.0312	.8 .03	.64 kg 1.42 lb	35.718 1.4062	K93891 : FLANGE ON OD LEFTFACE TAPERED OD
594R	95.250 3.7500	36.322 1.4300	8.0 .31	1.43 kg 3.15 lb	592XS	147.638 5.8125	26.192 1.0312	3.3 .13	.62 kg 1.38 lb	35.718 1.4062	K106815 : FLANGE ON OD LEFTFACE HOLES IN LEFTFACE TAPERED OD
594W	95.250 3.7500	36.322 1.4300	3.5 .14	1.45 kg 3.20 lb	593X	150.000 5.9055	27.000 1.0630	3.0 .12	.76 kg 1.67 lb	35.992 1.4170	
†J594X	95.000 3.7402	36.322 1.4300	8.0 .31	1.39 kg 3.07 lb	†JM719113	150.000 5.9055	27.000 1.0630	2.5 .10	.76 kg 1.68 lb	35.966 1.4160	K444675 : ASYMMETRICAL - TWO SERIES BEARING GROOVE IN OD LEFTFACE
595	82.550 3.2500	36.322 1.4300	3.5 .14	1.95 kg 4.30 lb							
595A	79.375 3.1250	36.322 1.4300	3.5 .14	2.06 kg 4.55 lb							
596	85.725 3.3750	36.322 1.4300	3.5 .14	1.83 kg 4.03 lb							
596-S	87.312 3.4375	36.322 1.4300	3.5 .14	1.77 kg 3.90 lb							
596W	93.662 3.6875	36.322 1.4300	3.5 .14	1.53 kg 3.38 lb							
597	93.662 3.6875	36.322 1.4300	3.5 .14	1.51 kg 3.33 lb							
597A	91.351 3.5965	36.322 1.4300	3.5 .14	1.61 kg 3.54 lb							
597X	90.000 3.5433	36.322 1.4300	3.0 .12	1.66 kg 3.67 lb							

†These Maximum Fillet Radii will be cleared by the Cone or Cup Radii.  
†Bore or O.D. shown are maximum dimensions. \* See Remarks Column.

595 – 635 SERIES

2

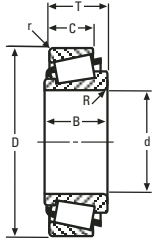

SINGLE ROW

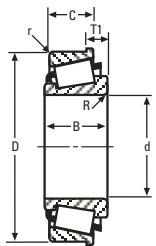

SINGLE ROW WITH FLANGE

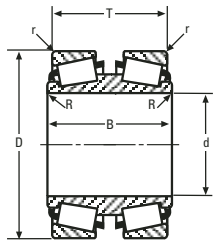

DOUBLE CONE

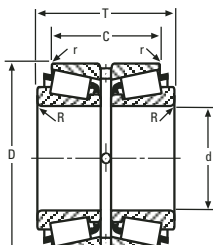

DOUBLE CUP

CONE			Max Shaft Fillet Radii R <sup>**</sup>	Weight	CUP			Max H's'ng Fillet Radii r <sup>**</sup>	Weight	BEARING WIDTH T	Remarks
Number	BORE d	WIDTH B			Number	OUTSIDE DIA D	WIDTH C				
<b>595 Series (cont)</b>											
598	92.075 3.6250	36.322 1.4300	3.5 .14	1.58 kg 3.47 lb							
598A	92.075 3.6250	36.322 1.4300	6.4 .25	1.54 kg 3.40 lb							
598W	92.075 3.6250	36.322 1.4300	3.5 .14	1.58 kg 3.48 lb							
598X	92.075 3.6250	36.322 1.4300	3.5 .14	1.57 kg 3.46 lb							
599X	85.000 3.3465	36.322 1.4300	3.0 .12	1.86 kg 4.10 lb							
NA593	88.900 3.5000	41.275 1.6250	3.5 .14	3.61 kg 7.96 lb	*592D	152.400 6.0000	63.500 2.5000	.8 .03	2.29 kg 5.04 lb	82.550 3.2500	
*NA593-SW	88.900 3.5000	41.275 1.6250	3.5 .14	3.56 kg 7.85 lb	*592DC	152.400 6.0000	63.500 2.5000	.8 .03	2.29 kg 5.04 lb	82.550 3.2500	
					*K87718	250.825 9.8750	101.600 4.0000	3.3 .13	28.58 kg 63.02 lb	82.550 3.2500	
					*K93891	254.000 10.0000	101.600 4.0000	3.3 .13	29.37 kg 64.75 lb	82.550 3.2500	
					K101989	250.825 9.8750	101.600 4.0000	3.3 .13	28.03 kg 61.82 lb	82.550 3.2500	
					*K106815	254.000 10.0000	101.600 4.0000	3.3 .13	29.62 kg 65.31 lb	82.550 3.2500	
					*K444675	161.925 6.3750	79.375 3.1250	.8 .03	3.58 kg 7.90 lb	82.550 3.2500	
					K516773	249.974 9.8415	101.600 4.0000	3.3 .13	26.78 kg 59.05 lb	82.550 3.2500	
*NA596-SW	88.900 3.5000	46.038 1.8125	3.5 .14	3.71 kg 8.18 lb	NA596-SW may be paired with all double cups corresponding to NA593 and will require 9.525 mm (.3750 in) to be added to the T-width values.						
<b>615 Series</b>											
615	44.450 1.7500	41.275 1.6250	3.5 .14	1.58 kg 3.48 lb	612	120.650 4.7500	31.750 1.2500	3.3 .13	.85 kg 1.87 lb	41.275 1.6250	617W: KEYWAY IN ID 623V: MADE FROM VACUUM MELT STEEL
617	47.625 1.8750	41.275 1.6250	3.5 .14	1.50 kg 3.31 lb	612A	120.040 4.7260	31.750 1.2500	3.3 .13	.82 kg 1.81 lb	41.275 1.6250	612-B: FLANGE ON OD FRONTFACE, BEARING WIDTH IS T1 DIMENSION
*617W	47.625 1.8750	41.275 1.6250	1.5 .06	1.52 kg 3.36 lb	*612-B	120.650 4.7500	31.750 1.2500	3.3 .13	.92 kg 2.02 lb	16.667 .6562	612V: MADE FROM VACUUM MELT STEEL
619	50.800 2.0000	41.275 1.6250	3.5 .14	1.42 kg 3.13 lb	612-S	120.650 4.7500	31.750 1.2500	.8 .03	.86 kg 1.90 lb	41.275 1.6250	612X: KEYWAY IN OD BACKFACE
620	39.688 1.5625	41.275 1.6250	.8 .03	1.68 kg 3.71 lb	*612V	120.650 4.7500	31.750 1.2500	3.3 .13	.85 kg 1.87 lb	41.275 1.6250	613-B: FLANGE ON OD FRONTFACE, BEARING WIDTH IS T1 DIMENSION
621	53.975 2.1250	41.275 1.6250	3.5 .14	1.34 kg 2.95 lb	*612X	120.650 4.7500	31.750 1.2500	3.3 .13	.85 kg 1.88 lb	41.275 1.6250	
621-S	53.975 2.1250	41.275 1.6250	3.5 .14	1.34 kg 2.94 lb	*613-B	120.650 4.7500	34.925 1.3750	3.3 .13	.93 kg 2.06 lb	12.700 .5000	
622A	55.006 2.1656	41.275 1.6250	.8 .03	1.32 kg 2.90 lb	613-S	114.300 4.5000	30.162 1.1875	1.5 .06	.54 kg 1.19 lb	40.183 1.5820	
622X	55.000 2.1654	41.275 1.6250	3.0 .12	1.31 kg 2.89 lb	613X	120.000 4.7244	30.988 1.2200	3.0 .12	.79 kg 1.74 lb	40.023 1.5757	
623	57.150 2.2500	41.275 1.6250	3.5 .14	1.25 kg 2.75 lb	614X	115.000 4.5276	31.496 1.2400	3.0 .12	.59 kg 1.29 lb	41.021 1.6150	
623A	57.150 2.2500	41.275 1.6250	6.4 .25	1.23 kg 2.70 lb							
*623V	57.150 2.2500	41.275 1.6250	3.5 .14	1.25 kg 2.75 lb							
624	53.975 2.1250	41.275 1.6250	.8 .03	1.35 kg 2.97 lb							
623-S	57.150 2.2500	38.100 1.5000	2.3 .09	1.23 kg 2.72 lb	623-S may be paired with all single cups corresponding to 615 and will require -2.083 mm (-.0820 in) to be added to the T-width values.						
<b>635 Series</b>											
635	57.150 2.2500	41.275 1.6250	3.5 .14	1.99 kg 4.38 lb	632	136.525 5.3750	31.750 1.2500	3.3 .13	1.04 kg 2.30 lb	41.275 1.6250	639X: BACKFACE CHAMFER
636	53.975 2.1250	41.275 1.6250	3.5 .14	2.08 kg 4.58 lb	632A	136.525 5.3750	39.688 1.5625	3.3 .13	1.18 kg 2.60 lb	41.275 1.6250	NA643-SW: FRONTFACE CHAMFER SLOTS IN FRONTFACE

635 SERIES CONTINUED ON NEXT PAGE

\*\*These Maximum Fillet Radii will be cleared by the Cone or Cup Radii.  
†Bore or O.D. shown are maximum dimensions. \* See Remarks Column.



2

CONE				Max Shaft Fillet Radii R <sup>†</sup>	Weight	CUP			Max Hs'ng Fillet Radii r <sup>†</sup>	Weight	BEAR-ING	Remarks
Number	BORE d	WIDTH B				Number	OUTSIDE DIA D	WIDTH C				
<b>635 Series (cont)</b>												
637	60.325 2.3750	41.275 1.6250	3.5 .14	1.89 kg 4.17 lb	*632AS	136.525 5.3750	55.562 2.1875	1.5 .06	1.70 kg 3.74 lb	55.560 2.1874	NA646-SW: FRONTFACE CHAMFER SHOULDER ON OD BACKFACE SLOTS IN FRONTFACE  632-B : FLANGE ON OD FRONTFACE, BEARING WIDTH IS T1 DIMENSION  632-S : KEYWAY IN OD BACKFACE THREADED OD FRONTFACE  632AS : KEYWAY IN OD SURFACE THREADED OD FRONTFACE  632D : GROOVE IN OD CENTER HOLES IN OD CENTER  632DC : HOLES IN OD CENTER 634W : KEYWAY BACKFACE SLOTS OD SURFACE	
639	63.500 2.5000	41.275 1.6250	3.5 .14	1.79 kg 3.95 lb	*632-B	136.525 5.3750	31.750 1.2500	3.3 .13	1.12 kg 2.48 lb	16.662 .6560		
*639X	63.500 2.5000	41.275 1.6250	spcl. spcl.	1.74 kg 3.83 lb	*632D	136.525 5.3750	76.200 3.0000	1.5 .06	2.56 kg 5.63 lb	95.250 3.7500		
641	66.675 2.6250	41.275 1.6250	3.5 .14	1.69 kg 3.72 lb	*632DC	136.525 5.3750	76.200 3.0000	1.5 .06	2.56 kg 5.63 lb	95.250 3.7500		
642	68.262 2.6875	41.275 1.6250	3.5 .14	1.63 kg 3.60 lb	*632-S	136.525 5.3750	41.275 1.6250	.8 .03	1.21 kg 2.67 lb	41.275 1.6250		
643	69.850 2.7500	41.275 1.6250	3.5 .14	1.58 kg 3.48 lb	633	130.175 5.1250	31.750 1.2500	3.3 .13	.70 kg 1.54 lb	41.275 1.6250		
644	71.438 2.8125	41.275 1.6250	3.5 .14	1.53 kg 3.37 lb	633X	130.000 5.1181	31.750 1.2500	3.0 .12	.69 kg 1.52 lb	41.275 1.6250		
645	71.438 2.8125	41.275 1.6250	6.4 .25	1.49 kg 3.30 lb	*634W	136.525 5.3750	35.720 1.4063	1.5 .06	1.23 kg 2.72 lb	45.245 1.7813		
645X	71.438 2.8125	41.275 1.6250	6.4 .25	1.49 kg 3.29 lb								
NA643	69.850 2.7500	47.625 1.8750	3.5 .14	3.33 kg 7.34 lb	*632D	136.525 5.3750	76.200 3.0000	1.5 .06	2.56 kg 5.63 lb	95.250 3.7500		K516780 : SPECIAL RADIUS ON LEFTFACE OD SPECIAL RADIUS ON RIGHTFACE OD
*NA643-SW	69.850 2.7500	47.625 1.8750	3.5 .14	3.37 kg 7.42 lb	*632DC	136.525 5.3750	76.200 3.0000	1.5 .06	2.56 kg 5.63 lb	95.250 3.7500		
					*K516780	159.974 6.2982	87.889 3.4602	spcl. spcl.	6.66 kg 14.69 lb	95.250 3.7500		
639A	63.500 2.5000	46.025 1.8120	6.4 .25	1.94 kg 4.27 lb	639A may be paired with all single cups corresponding to 635 and will require 4.750 mm (.1870 in) to be added to the T-width values. 639A may be paired with all double cups corresponding to 635 and will require 9.500 mm (.3740 in) to be added to the T-width values.							
*NA646-SW	69.987 2.7554	44.920 1.7685	3.0 .12	3.27 kg 7.21 lb	NA646-SW may be paired with all double cups corresponding to NA643 and will require -5.410 mm (-.2130 in) to be added to the T-width values.							
<b>655 Series</b>												
655	69.850 2.7500	41.275 1.6250	3.5 .14	2.37 kg 5.22 lb	652	152.400 6.0000	31.750 1.2500	3.3 .13	1.24 kg 2.74 lb	41.275 1.6250	NA659-SW: FRONTFACE CHAMFER SLOTS IN FRONTFACE  652-B: FLANGE ON OD FRONTFACE, BEARING WIDTH IS T1 DIMENSION	
656	64.960 2.5575	41.275 1.6250	3.5 .14	2.54 kg 5.59 lb	652A	149.225 5.8750	31.750 1.2500	3.3 .13	1.05 kg 2.33 lb	41.275 1.6250		
657	73.025 2.8750	41.275 1.6250	3.5 .14	2.25 kg 4.97 lb	*652-B	152.400 6.0000	31.750 1.2500	3.3 .13	1.35 kg 2.97 lb	16.667 .6562	653DT: ASYMMETRICAL BEARING GROOVE IN OD CENTER HOLES IN OD CENTER REVERSE TAPERED OD SPECIAL RADIUS ON LEFTFACE OD SPECIAL RADIUS ON RIGHTFACE OD	
658	74.612 2.9375	41.275 1.6250	3.5 .14	2.19 kg 4.84 lb	653	146.050 5.7500	31.750 1.2500	3.3 .13	.87 kg 1.92 lb	41.275 1.6250		
659	76.200 3.0000	41.275 1.6250	3.5 .14	2.13 kg 4.70 lb	*653DT	158.750 6.2500	76.200 3.0000	spcl. spcl.	3.24 kg 7.14 lb	95.250 3.7500		
661	79.375 3.1250	41.275 1.6250	3.5 .14	2.01 kg 4.42 lb	653X	150.000 5.9055	31.750 1.2500	3.0 .12	1.10 kg 2.43 lb	41.275 1.6250		
663	82.550 3.2500	41.275 1.6250	3.5 .14	1.88 kg 4.14 lb	*654D	152.400 6.0000	76.200 3.0000	1.5 .06	3.08 kg 6.80 lb	95.250 3.7500	654D: GROOVE IN OD CENTER HOLES IN OD CENTER  654DC: HOLES IN OD CENTER	
663A	82.550 3.2500	41.275 1.6250	6.8 .27	1.84 kg 4.05 lb	*654DC	152.400 6.0000	76.200 3.0000	1.5 .06	3.08 kg 6.80 lb	95.250 3.7500		
664	84.138 3.3125	41.275 1.6250	3.5 .14	1.81 kg 3.99 lb								
665	85.725 3.3750	41.275 1.6250	3.5 .14	1.74 kg 3.84 lb								
665A	85.725 3.3750	41.275 1.6250	6.4 .25	1.71 kg 3.77 lb								
665X	85.000 3.3465	41.275 1.6250	3.5 .14	1.77 kg 3.91 lb								
NA659	76.200 3.0000	47.625 1.8750	3.5 .14	4.56 kg 10.04 lb	*653DT	158.750 6.2500	76.200 3.0000	spcl. spcl.	3.24 kg 7.14 lb	95.250 3.7500		

<sup>†</sup>These Maximum Fillet Radii will be cleared by the Cone or Cup Radii.  
<sup>†</sup>Bore or O.D. shown are maximum dimensions. \* See Remarks Column.

655 – 675 SERIES

2

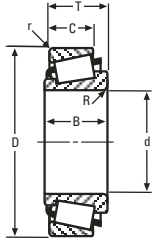

SINGLE ROW



SINGLE ROW WITH FLANGE

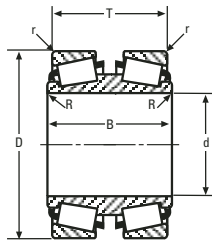

DOUBLE CONE

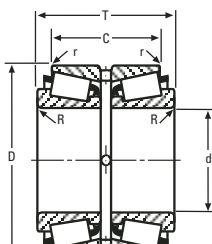

DOUBLE CUP

CONE			Max Shaft Fillet Radii R <sup>**</sup>	Weight	CUP			Max Hs'ng Fillet Radii r <sup>**</sup>	Weight	BEARING		Remarks
Number	BORE d	WIDTH B			Number	OUTSIDE DIA D	WIDTH C			WIDTH T		
<b>655 Series (cont)</b>												
*NA659-SW	76.200 3.0000	47.625 1.8750	3.5 .14	4.58 kg 10.11 lb	*654D	152.400 6.0000	76.200 3.0000	1.5 .06	3.08 kg 6.80 lb	95.250 3.7500		
					*654DC	152.400 6.0000	76.200 3.0000	1.5 .06	3.08 kg 6.80 lb	95.250 3.7500		
662	80.962 3.1875	38.100 1.5000	3.5 .14	1.82 kg 4.01 lb	662 may be paired with all single cups corresponding to 655 and will require -3.175 mm (-.1250 in) to be added to the T-width values. 662 may be paired with all double cups corresponding to 655 and will require -6.350 mm (-.2500 in) to be added to the T-width values.							
<b>675 Series</b>												
677	85.725 3.3750	41.275 1.6250	3.5 .14	2.90 kg 6.39 lb	672	168.275 6.6250	30.162 1.1875	3.3 .13	1.22 kg 2.69 lb	41.275 1.6250	688TD: TAPERED BORE	
679	88.900 3.5000	41.275 1.6250	3.5 .14	2.76 kg 6.08 lb	672A	168.275 6.6250	34.925 1.3750	3.3 .13	1.32 kg 2.91 lb	41.274 1.6250	NA691: EXTENDED SMALL RIB	
681	92.075 3.6250	41.275 1.6250	3.5 .14	2.61 kg 5.76 lb	*672-B	168.275 6.6250	30.162 1.1875	3.3 .13	1.33 kg 2.94 lb	18.255 .7187	NA691-SW: EXTENDED SMALL RIB SLOTS IN FRONTFACE	
681A	92.075 3.6250	41.275 1.6250	6.4 .25	2.58 kg 5.68 lb	*672D	168.275 6.6250	69.850 2.7500	.8 .03	3.12 kg 6.88 lb	92.075 3.6250	672-B: FLANGE ON OD FRONTFACE, BEARING WIDTH IS T1 DIMENSION	
681W	92.075 3.6250	41.275 1.6250	3.5 .14	2.62 kg 5.77 lb	*672DC	168.275 6.6250	69.850 2.7500	.8 .03	3.12 kg 6.88 lb	92.075 3.6250	672D: GROOVE IN OD CENTER HOLES IN OD CENTER	
682	94.976 3.7392	41.275 1.6250	3.5 .14	2.47 kg 5.45 lb	672P	168.275 6.6250	30.162 1.1875	3.3 .13	1.22 kg 2.70 lb	41.275 1.6250	672DC: HOLES IN OD CENTER	
683	95.250 3.7500	41.275 1.6250	3.5 .14	2.46 kg 5.42 lb	673	169.974 6.6919	30.162 1.1875	3.3 .13	1.33 kg 2.93 lb	41.275 1.6250	675DRB: GROOVE IN OD LEFTFACE	
683WA	95.250 3.7500	41.275 1.6250	3.5 .14	2.39 kg 5.28 lb	673X	170.000 6.6929	30.162 1.1875	3.0 .12	1.33 kg 2.94 lb	41.275 1.6250		
683X	95.000 3.7402	41.275 1.6250	3.5 .14	2.47 kg 5.45 lb	674	171.450 6.7500	30.162 1.1875	3.3 .13	1.40 kg 3.08 lb	41.275 1.6250		
683XA	95.250 3.7500	41.275 1.6250	5.0 .20	2.44 kg 5.39 lb	*675DRB	174.625 6.8750	69.850 2.7500	.8 .03	4.00 kg 8.81 lb	92.075 3.6250		
685	98.425 3.8750	41.275 1.6250	3.5 .14	2.30 kg 5.08 lb	672	168.275 6.6250	30.162 1.1875	3.3 .13	1.22 kg 2.69 lb	95.250 3.7500		
685W	98.425 3.8750	41.275 1.6250	3.5 .14	2.29 kg 5.05 lb	672A	168.275 6.6250	34.925 1.3750	3.3 .13	1.32 kg 2.91 lb	95.250 3.7500		
687	101.600 4.0000	41.275 1.6250	3.5 .14	2.14 kg 4.72 lb	672P	168.275 6.6250	30.162 1.1875	3.3 .13	1.22 kg 2.70 lb	95.250 3.7500		
687P	101.600 4.0000	41.275 1.6250	3.5 .14	2.16 kg 4.75 lb	673	169.974 6.6919	30.162 1.1875	3.3 .13	1.33 kg 2.93 lb	95.250 3.7500		
689	103.188 4.0625	41.275 1.6250	3.5 .14	2.06 kg 4.54 lb	673X	170.000 6.6929	30.162 1.1875	3.0 .12	1.33 kg 2.94 lb	95.250 3.7500		
*688TD	100.211 3.9453	95.250 3.7500	.8 .03	6.57 kg 14.48 lb	674	171.450 6.7500	30.162 1.1875	3.3 .13	1.40 kg 3.08 lb	95.250 3.7500		
*NA691	101.600 4.0000	46.038 1.8125	3.5 .14	4.45 kg 9.81 lb	*672D	168.275 6.6250	69.850 2.7500	.8 .03	3.12 kg 6.88 lb	92.075 3.6250		
*NA691-SW	101.600 4.0000	46.038 1.8125	3.5 .14	4.69 kg 10.35 lb	*672DC	168.275 6.6250	69.850 2.7500	.8 .03	3.12 kg 6.88 lb	92.075 3.6250		
					*675DRB	174.625 6.8750	69.850 2.7500	.8 .03	4.00 kg 8.81 lb	92.075 3.6250		
686	94.976 3.7392	40.488 1.5940	3.5 .14	2.43 kg 5.36 lb	686 may be paired with all single cups corresponding to 677 and will require -.787 mm (-.0310 in) to be added to the T-width values. 686 may be paired with all double cups corresponding to 677 and will require -1.575 mm (-.0620 in) to be added to the T-width values.							

745 SERIES CONTINUED ON NEXT PAGE

\*\*These Maximum Fillet Radii will be cleared by the Cone or Cup Radii.  
†Bore or O.D. shown are maximum dimensions. \* See Remarks Column.

2

CONE			Max Shaft Fillet Radii R''	Weight	CUP			Max Hs'ng Fillet Radii r''	Weight	BEAR-ING	Remarks
Number	BORE d	WIDTH B			Number	OUTSIDE DIA D	WIDTH C			WIDTH T	
<b>745 Series</b>											
740	80.962 3.1875	46.672 1.8375	5.0 .20	2.34 kg 5.15 lb	742	150.089 5.9090	36.512 1.4375	3.3 .13	1.07 kg 2.35 lb	44.450 1.7500	749V: MADE FROM VACUUM MELT STEEL 749W: KEYWAY IN ID
744	73.025 2.8750	46.672 1.8375	3.5 .14	2.70 kg 5.96 lb	742A	149.974 5.9045	36.512 1.4375	3.3 .13	1.04 kg 2.30 lb	44.450 1.7500	742-B: FLANGE ON OD FRONTFACE, BEARING WIDTH IS T1 DIMENSION
744A	69.850 2.7500	46.672 1.8375	5.2 .20	2.82 kg 6.22 lb	*742-B	150.089 5.9090	36.512 1.4375	3.3 .13	1.18 kg 2.59 lb	15.875 .6250	742D: GROOVE IN OD CENTER
745	59.931 2.3595	46.672 1.8375	3.5 .14	3.20 kg 7.06 lb	*742D	155.575 6.1250	85.725 3.3750	1.5 .06	3.46 kg 7.63 lb	101.600 4.0000	HOLES IN OD CENTER
745-S	63.500 2.5000	46.672 1.8375	3.5 .14	3.08 kg 6.78 lb	*742DC	155.575 6.1250	85.725 3.3750	1.5 .06	3.46 kg 7.63 lb	101.600 4.0000	742DC: HOLES IN OD CENTER
745A	69.850 2.7500	46.672 1.8375	3.5 .14	2.83 kg 6.25 lb	*742V	150.089 5.9090	36.512 1.4375	3.3 .13	1.05 kg 2.32 lb	44.450 1.7500	742V: MADE FROM VACUUM MELT STEEL
746	60.000 2.3622	46.672 1.8375	3.5 .14	3.20 kg 7.06 lb	*742X	150.089 5.9090	36.512 1.4375	3.3 .13	1.06 kg 2.33 lb	44.450 1.7500	742X: KEYWAY IN OD BACKFACE
747-S	64.960 2.5575	46.672 1.8375	3.5 .14	3.02 kg 6.67 lb	743	150.000 5.9055	35.000 1.3780	3.3 .13	1.02 kg 2.25 lb	44.455 1.7502	743DS: HOLES IN OD CENTER
748	80.000 3.1496	46.672 1.8375	3.0 .12	2.40 kg 5.29 lb	*743DS	168.275 6.6250	85.725 3.3750	1.5 .06	5.83 kg 12.85 lb	101.600 4.0000	
748-S	76.200 3.0000	46.672 1.8375	3.5 .14	2.57 kg 5.66 lb	743X	149.944 5.9033	35.000 1.3780	3.0 .12	1.02 kg 2.25 lb	44.455 1.7502	
749	85.026 3.3475	46.672 1.8375	3.5 .14	2.17 kg 4.78 lb	7464	149.225 5.8750	34.925 1.3750	3.3 .13	.93 kg 2.05 lb	42.863 1.6875	
749-S	85.026 3.3475	46.672 1.8375	5.0 .20	2.14 kg 4.72 lb							
749A	82.550 3.2500	46.672 1.8375	3.5 .14	2.28 kg 5.02 lb							
*749V	85.026 3.3475	46.672 1.8375	3.5 .14	2.16 kg 4.76 lb							
*749W	85.026 3.3475	46.672 1.8375	3.5 .14	2.15 kg 4.74 lb							
750	79.375 3.1250	46.672 1.8375	3.5 .14	2.42 kg 5.35 lb							
750A	82.550 3.2500	46.672 1.8375	6.5 .26	2.24 kg 4.94 lb							
750W	79.375 3.1250	46.672 1.8375	3.5 .14	2.42 kg 5.33 lb							
NA749	82.550 3.2500	50.800 2.0000	3.5 .14	4.68 kg 10.32 lb	*742D	155.575 6.1250	85.725 3.3750	1.5 .06	3.46 kg 7.63 lb	101.600 4.0000	
					*742DC	155.575 6.1250	85.725 3.3750	1.5 .06	3.46 kg 7.63 lb	101.600 4.0000	
					*743DS	168.275 6.6250	85.725 3.3750	1.5 .06	5.83 kg 12.85 lb	101.600 4.0000	
<b>755 Series</b>											
755	76.200 3.0000	48.260 1.9000	3.5 .14	3.09 kg 6.82 lb	752	161.925 6.3750	38.100 1.5000	3.3 .13	1.59 kg 3.51 lb	47.625 1.8750	NA759-SW: FRONTFACE CHAMFER SLOTS IN FRONTFACE
755W	76.200 3.0000	48.260 1.9000	3.5 .14	3.05 kg 6.73 lb	752A	159.995 6.2990	38.100 1.5000	.8 .03	1.47 kg 3.23 lb	47.625 1.8750	NA761-SW: FRONTFACE CHAMFER SLOTS IN FRONTFACE
756	82.550 3.2500	48.260 1.9000	11.2 .44	2.67 kg 5.88 lb	752AA	161.925 6.3750	38.100 1.5000	.5 .02	1.61 kg 3.55 lb	47.625 1.8750	752-B: FLANGE ON OD FRONTFACE, BEARING WIDTH IS T1 DIMENSION
756A	79.375 3.1250	48.260 1.9000	8.0 .31	2.89 kg 6.38 lb	*752-B	161.925 6.3750	38.100 1.5000	3.3 .13	1.72 kg 3.80 lb	17.450 .6870	752D: GROOVE IN OD CENTER
757	82.550 3.2500	48.260 1.9000	3.5 .14	2.79 kg 6.15 lb	*752D	161.925 6.3750	85.725 3.3750	1.5 .06	3.66 kg 8.06 lb	104.775 4.1250	HOLES IN OD CENTER
757W	82.550 3.2500	48.260 1.9000	3.5 .14	2.81 kg 6.20 lb	*752DC	161.925 6.3750	85.725 3.3750	1.5 .06	3.66 kg 8.06 lb	104.775 4.1250	752DC: HOLES IN OD CENTER
758	85.725 3.3750	48.260 1.9000	3.5 .14	2.63 kg 5.80 lb	753	168.275 6.6250	38.100 1.5000	3.3 .13	2.06 kg 4.55 lb	47.625 1.8750	753A: CHAMFER ON BACKFACE OD THREADED OD FRONTFACE
758W	85.725 3.3750	48.260 1.9000	3.5 .14	2.62 kg 5.79 lb	*753A	168.275 6.6250	49.212 1.9375	- .06	2.50 kg 5.52 lb	49.212 1.9375	754W: KEYWAY IN OD SURFACE THREADED OD FRONTFACE
759	88.900 3.5000	48.260 1.9000	3.5 .14	2.47 kg 5.44 lb	753X	160.000 6.2992	38.000 1.4961	3.3 .13	1.44 kg 3.18 lb	47.620 1.8748	
760	90.488 3.5625	48.260 1.9000	3.5 .14	2.38 kg 5.25 lb	*754W	168.275 6.6250	57.150 2.2500	3.3 .13	2.89 kg 6.38 lb	53.975 2.1250	K312486: SPECIAL RADIUS ON LEFTFACE OD SPECIAL RADIUS ON RIGHTFACE OD

\*\*These Maximum Fillet Radii will be cleared by the Cone or Cup Radii.  
†Bore or O.D. shown are maximum dimensions. \* See Remarks Column.

755 - 775 SERIES

2

CONE				Max Shaft Fillet Radii R**	Weight	CUP			Max Hs'ng Fillet Radii r**	Weight	BEARING		Remarks
Number	BORE d	WIDTH B				Number	OUTSIDE DIA D	WIDTH C				WIDTH T	
<b>755 Series (cont)</b>													
761W	88.900 3.5000	48.260 1.9000	3.5 .14	2.45 kg 5.39 lb									
762	73.025 2.8750	48.260 1.9000	3.5 .14	3.20 kg 7.06 lb									
762XA	73.025 2.8750	48.260 1.9000	3.5 .14	3.23 kg 7.13 lb									
766	88.900 3.5000	48.260 1.9000	7.0 .28	2.42 kg 5.34 lb									
767X	90.000 3.5433	48.260 1.9000	3.0 .12	2.41 kg 5.32 lb									
NA759	88.900 3.5000	52.388 2.0625	3.5 .14	5.07 kg 11.17 lb	*752D	161.925 6.3750	85.725 3.3750	1.5 .06	3.66 kg 8.06 lb	104.775 4.1250			
*NA759-SW	88.900 3.5000	52.388 2.0625	3.5 .14	5.11 kg 11.27 lb	*752DC	161.925 6.3750	85.725 3.3750	1.5 .06	3.66 kg 8.06 lb	104.775 4.1250			
*NA761-SW	88.900 3.5000	52.388 2.0625	3.5 .14	5.09 kg 11.23 lb	*K312486	206.375 8.1250	103.185 4.0624	spcl. spcl.	16.69 kg 36.81 lb	104.775 4.1250			
767D	88.900 3.5000	107.950 4.2500	1.5 .06	6.59 kg 14.52 lb	752	161.925 6.3750	38.100 1.5000	3.3 .13	1.59 kg 3.51 lb	101.549 3.9980			
					752A	159.995 6.2990	38.100 1.5000	.8 .03	1.47 kg 3.23 lb	101.549 3.9980			
					752AA	161.925 6.3750	38.100 1.5000	.5 .02	1.61 kg 3.55 lb	101.549 3.9980			
					753	168.275 6.6250	38.100 1.5000	3.3 .13	2.06 kg 4.55 lb	101.549 3.9980			
					*753A	168.275 6.6250	49.212 1.9375	- -	2.50 kg 5.52 lb	104.724 4.1230			
					753X	160.000 6.2992	38.000 1.4961	3.3 .13	1.44 kg 3.18 lb	101.539 3.9976			
762X	85.000 3.3465	48.489 1.9090	3.0 .12	2.69 kg 5.92 lb	762X may be paired with all single cups corresponding to 755 and will require .381 mm (.0150 in) to be added to the T-width values. 762X may be paired with all double cups corresponding to 755 and will require .762 mm (.0300 in) to be added to the T-width values.								
<b>775 Series</b>													
775	88.900 3.5000	48.006 1.8900	4.8 .19	3.81 kg 8.40 lb	772	180.975 7.1250	38.100 1.5000	3.3 .13	1.92 kg 4.24 lb	47.625 1.8750			NA776-SW: FRONTFACE CHAMFER SLOTS IN FRONTFACE
776	95.250 3.7500	48.006 1.8900	3.5 .14	3.47 kg 7.66 lb	772A	174.625 6.8750	38.100 1.5000	3.3 .13	1.39 kg 3.06 lb	47.625 1.8750			782W: KEYWAY IN ID
776W	95.250 3.7500	48.006 1.8900	3.5 .14	3.45 kg 7.61 lb	*772-B	180.975 7.1250	38.100 1.5000	3.3 .13	2.08 kg 4.58 lb	17.462 .6875			787TD: TAPERED BORE
777	95.250 3.7500	48.006 1.8900	9.5 .38	3.38 kg 7.44 lb	773	180.000 7.0866	40.000 1.5748	3.0 .12	1.89 kg 4.17 lb	48.000 1.8898			772-B: FLANGE ON OD FRONTFACE, BEARING WIDTH IS T1 DIMENSION
778	92.075 3.6250	48.006 1.8900	3.5 .14	3.65 kg 8.05 lb	773AA	179.974 7.0856	38.100 1.5000	3.0 .12	1.84 kg 4.06 lb	47.625 1.8750			773D: GROOVE IN OD CENTER HOLES IN OD CENTER
779	98.425 3.8750	48.006 1.8900	3.5 .14	3.29 kg 7.26 lb	*773D	180.000 7.0866	85.725 3.3750	.8 .03	4.27 kg 9.42 lb	104.775 4.1250			773DC: HOLES IN OD CENTER
779W	98.425 3.8750	48.006 1.8900	3.5 .14	3.23 kg 7.12 lb	*773DC	180.000 7.0866	85.725 3.3750	.8 .03	4.27 kg 9.42 lb	104.775 4.1250			774-BW: FLANGE ON OD FRONTFACE, BEARING WIDTH IS T1 DIMENSION KEYWAY IN OD SURFACE
780	101.600 4.0000	48.006 1.8900	3.5 .14	3.10 kg 6.85 lb	*774-BW	184.150 7.2500	47.625 1.8750	3.3 .13	2.73 kg 6.02 lb	7.938 .3125			774D: GROOVE IN OD CENTER HOLES IN OD CENTER
780W	101.600 4.0000	48.006 1.8900	3.5 .14	3.05 kg 6.73 lb	*774D	180.975 7.1250	85.725 3.3750	1.5 .06	4.22 kg 9.30 lb	104.775 4.1250			
782	104.775 4.1250	48.006 1.8900	3.5 .14	2.91 kg 6.42 lb	*774DC	180.975 7.1250	85.725 3.3750	1.5 .06	4.53 kg 9.98 lb	104.775 4.1250			774DC: HOLES IN OD CENTER
*782W	104.775 4.1250	48.006 1.8900	3.5 .14	2.85 kg 6.27 lb									
783	100.000 3.9370	48.006 1.8900	3.5 .14	3.20 kg 7.06 lb									
783A	99.974 3.9360	50.800 2.0000	3.0 .12	3.30 kg 7.27 lb									
783W	100.000 3.9370	48.006 1.8900	3.5 .14	3.20 kg 7.05 lb									

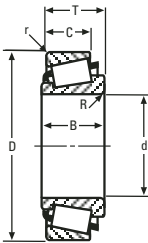

SINGLE ROW

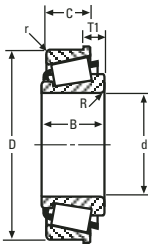

SINGLE ROW WITH FLANGE

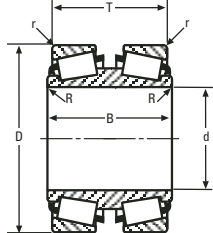

DOUBLE CONE

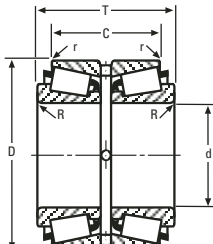

DOUBLE CUP

775 SERIES CONTINUED ON NEXT PAGE

\*\*These Maximum Fillet Radii will be cleared by the Cone or Cup Radii.  
†Bore or O.D. shown are maximum dimensions. \* See Remarks Column.

2

CONE				Max Shaft Fillet Radii R <sup>†</sup>	Weight	CUP			Max Hs'ng Fillet Radii r <sup>†</sup>	Weight	BEAR-ING	Remarks	
Number	BORE d	WIDTH B				Number	OUTSIDE DIA D	WIDTH C					WIDTH T
<b>775 Series (cont)</b>													
786	104.775 4.1250	48.006 1.8900	6.4 .25	2.87 kg 6.34 lb									
787	104.775 4.1250	48.006 1.8900	7.1 .28	2.86 kg 6.30 lb									
789	100.813 3.9690	47.625 1.8750	3.5 .14	3.14 kg 6.92 lb									
NA776	95.250 3.7500	52.388 2.0625	3.5 .14	7.23 kg 15.94 lb	*773D	180.000 7.0866	85.725 3.3750	.8 .03	4.27 kg 9.42 lb	104.775 4.1250			
*NA776-SW	95.250 3.7500	52.388 2.0625	3.5 .14	7.23 kg 15.93 lb	*773DC	180.000 7.0866	85.725 3.3750	.8 .03	4.27 kg 9.42 lb	104.775 4.1250			
NA780	101.600 4.0000	52.388 2.0625	3.5 .14	6.42 kg 14.16 lb	*774D	180.975 7.1250	85.725 3.3750	1.5 .06	4.22 kg 9.30 lb	104.775 4.1250			
NA782	104.775 4.1250	52.388 2.0625	3.5 .14	6.00 kg 13.22 lb	*774DC	180.975 7.1250	85.725 3.3750	1.5 .06	4.53 kg 9.98 lb	104.775 4.1250			
779D	98.425 3.8750	102.362 4.0300	1.6 .06	8.29 kg 18.29 lb	772	180.975 7.1250	38.100 1.5000	3.3 .13	1.92 kg 4.24 lb	101.600 4.0000			
782D	104.775 4.1250	102.362 4.0300	1.6 .06	7.48 kg 16.49 lb	772A	174.625 6.8750	38.100 1.5000	3.3 .13	1.39 kg 3.06 lb	101.600 4.0000			
*787TD	104.775 4.1250	104.775 4.1250	1.5 .06	8.39 kg 18.50 lb	773	180.000 7.0866	40.000 1.5748	3.0 .12	1.89 kg 4.17 lb	102.352 4.0296			
					773AA	179.974 7.0856	38.100 1.5000	3.0 .12	1.84 kg 4.06 lb	101.600 4.0000			
778D	98.425 3.8750	96.825 3.8120	1.6 .06	8.01 kg 17.67 lb	778D may be paired with all single cups corresponding to 779D and will require -.6350 mm (-.2500 in) to be added to the T-width values.								
<b>795 Series</b>													
795	120.650 4.7500	47.625 1.8750	3.3 .13	4.46 kg 9.83 lb	*792-B	206.375 8.1250	34.925 1.3750	3.3 .13	2.09 kg 4.60 lb	20.638 .8125	795DE: EXTENDED SMALL RIB		
796X	127.000 5.0000	47.625 1.8750	3.5 .14	4.00 kg 8.81 lb	792	206.375 8.1250	34.925 1.3750	3.3 .13	1.88 kg 4.15 lb	47.625 1.8750	796DE: EXTENDED SMALL RIB		
797	130.000 5.1181	47.625 1.8750	3.5 .14	3.77 kg 8.31 lb	*792CD	206.375 8.1250	82.550 3.2500	.8 .03	4.41 kg 9.73 lb	107.950 4.2500	796DEE: EXTENDED SMALL RIB		
798	127.000 5.0000	50.013 1.9690	3.3 .13	4.03 kg 8.88 lb	793	206.375 8.1250	34.925 1.3750	3.3 .13	1.90 kg 4.18 lb	47.625 1.8750	797DA: EXTENDED SMALL RIB HOLES IN OD LEFTFACE		
799	128.587 5.0625	47.625 1.8750	3.3 .13	3.88 kg 8.55 lb	*793DE	206.375 8.1250	82.550 3.2500	.8 .03	5.02 kg 11.08 lb	107.950 4.2500	797DE: EXTENDED SMALL RIB		
799A	130.175 5.1250	47.625 1.8750	3.5 .14	3.76 kg 8.28 lb							797DEE: EXTENDED SMALL RIB		
799W	128.587 5.0625	47.625 1.8750	3.3 .13	3.92 kg 8.64 lb							797TD: ASYMMETRICAL BEARING TAPERED BORE		
*795DE	120.000 4.7244	184.150 7.2500	.8 .03	14.79 kg 32.62 lb	792	206.375 8.1250	34.925 1.3750	3.3 .13	1.88 kg 4.15 lb	95.250 3.7500	798DA: EXTENDED SMALL RIB HOLES IN OD LEFTFACE		
*796DE	125.000 4.9213	184.150 7.2500	.8 .03	13.43 kg 29.61 lb	793	206.375 8.1250	34.925 1.3750	3.3 .13	1.90 kg 4.18 lb	95.250 3.7500	798DE: EXTENDED SMALL RIB		
*796DEE	125.000 4.9213	184.150 7.2500	.8 .03	13.46 kg 29.68 lb							798DEE: EXTENDED SMALL RIB		
*797DA	125.412 4.9375	157.958 6.2188	.8 .03	12.41 kg 27.37 lb							NA798-SW: FRONTFACE CHAMFER SLOTS IN FRONTFACE		
*797DE	125.412 4.9375	184.150 7.2500	.8 .03	13.24 kg 29.20 lb							792-B : FLANGE ON OD FRONTFACE, BEARING WIDTH IS T1 DIMENSION		
*797DEE	125.412 4.9375	184.150 7.2500	.8 .03	13.24 kg 29.20 lb							792CD : GROOVE IN OD CENTER HOLES IN OD CENTER		
*798DA	127.000 5.0000	157.958 6.2188	.8 .03	12.02 kg 26.51 lb							793DE: GROOVE IN OD CENTER HOLES IN OD CENTER		
*798DE	127.000 5.0000	184.150 7.2500	.8 .03	12.82 kg 28.27 lb									
*798DEE	127.000 5.0000	184.150 7.2500	.8 .03	12.82 kg 28.27 lb									
NA798	127.000 5.0000	53.975 2.1250	3.5 .14	- -	*792CD	206.375 8.1250	82.550 3.2500	.8 .03	4.41 kg 9.73 lb	107.950 4.2500			

<sup>†</sup>These Maximum Fillet Radii will be cleared by the Cone or Cup Radii.  
†Bore or O.D. shown are maximum dimensions. \* See Remarks Column.

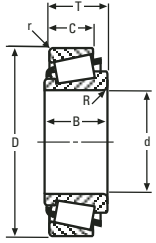

SINGLE ROW



SINGLE ROW WITH FLANGE

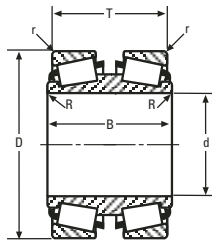

DOUBLE CONE

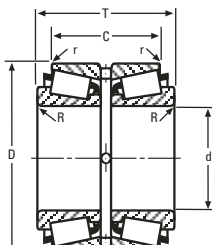

DOUBLE CUP

CONE			Max Shaft Fillet Radii R**	Weight	CUP			Max Hs'ng Fillet Radii r**	Weight	BEARING		Remarks
Number	BORE d	WIDTH B			Number	OUTSIDE DIA D	WIDTH C			WIDTH T		
795 Series (cont)												
*NA798-SW	127.000 5.0000	53.975 2.1250	3.5 .14	- -	*793DE	206.375 8.1250	82.550 3.2500	.8 .03	5.02 kg 11.08 lb	107.950 4.2500		
*797TD	125.412 4.9375	114.300 4.5000	1.5 .06	12.32 kg 27.17 lb	797TD may be paired with all single cups corresponding to 795DE and will require 19.050 mm (.7500 in) to be added to the T-width values.							
835 Series												
835	69.850 2.7500	56.363 2.2190	3.5 .14	4.42 kg 9.75 lb	832	168.275 6.6250	41.275 1.6250	3.3 .13	1.74 kg 3.83 lb	53.975 2.1250	843V: MADE FROM VACUUM MELT STEEL	
837	76.200 3.0000	56.363 2.2190	.8 .03	4.11 kg 9.06 lb	*832-B	168.275 6.6250	41.275 1.6250	3.3 .13	1.92 kg 4.23 lb	22.225 .8750	850V: MADE FROM VACUUM MELT STEEL	
838	80.962 3.1875	56.363 2.2190	.8 .03	3.85 kg 8.49 lb	*832V	168.275 6.6250	41.275 1.6250	3.3 .13	1.74 kg 3.83 lb	53.975 2.1250	832-B: FLANGE ON OD FRONTFACE, BEARING WIDTH IS T1 DIMENSION	
839	82.550 3.2500	56.363 2.2190	.8 .03	3.76 kg 8.29 lb	*833W	168.275 6.6250	44.450 1.7500	3.3 .13	1.85 kg 4.09 lb	57.150 2.2500	832V: MADE FROM VACUUM MELT STEEL	
841	85.725 3.3750	56.363 2.2190	3.5 .14	3.56 kg 7.86 lb	833X	170.000 6.6929	41.000 1.6142	3.0 .12	1.86 kg 4.11 lb	53.975 2.1250	833W: KEYWAY BACKFACE	
842	82.550 3.2500	56.363 2.2190	3.5 .14	3.75 kg 8.27 lb	*834D	171.450 6.7500	100.012 3.9375	.8 .03	5.42 kg 11.96 lb	125.413 4.9375	834D: GROOVE IN OD CENTER HOLES IN OD CENTER	
843	76.200 3.0000	56.363 2.2190	6.4 .25	4.09 kg 9.02 lb							K103951: SPECIAL RADIUS ON LEFTFACE OD SPECIAL RADIUS ON RIGHTFACE OD	
*843V	76.200 3.0000	56.363 2.2190	6.4 .25	4.09 kg 9.02 lb								
850	88.900 3.5000	56.363 2.2190	3.5 .14	3.37 kg 7.43 lb								
850A	89.891 3.5390	56.363 2.2190	3.5 .14	3.31 kg 7.30 lb								
*850V	88.900 3.5000	56.363 2.2190	3.5 .14	3.37 kg 7.43 lb								
850W	88.900 3.5000	56.363 2.2190	3.5 .14	3.35 kg 7.38 lb								
NA842	82.550 3.2500	62.708 2.4688	3.5 .14	7.80 kg 17.20 lb	*834D	171.450 6.7500	100.012 3.9375	.8 .03	5.42 kg 11.96 lb	125.415 4.9376		
					*K103951	215.900 8.5000	120.650 4.7500	spcl. spcl.	18.64 kg 41.10 lb	125.415 4.9376		
855 Series												
855	88.900 3.5000	57.531 2.2650	8.0 .31	5.02 kg 11.06 lb	852	190.500 7.5000	47.625 1.8750	3.3 .13	2.78 kg 6.12 lb	57.150 2.2500	861V: MADE FROM VACUUM MELT STEEL	
857	92.075 3.6250	57.531 2.2650	8.0 .31	4.81 kg 10.61 lb	853	190.000 7.4803	48.000 1.8898	3.0 .12	2.73 kg 6.02 lb	57.000 2.2441	861W: KEYWAY IN ID	
861	101.600 4.0000	57.531 2.2650	8.0 .31	4.15 kg 9.16 lb	854	190.500 7.5000	44.450 1.7500	3.3 .13	2.65 kg 5.85 lb	57.150 2.2500	864W: KEYWAY IN ID	
861-SW	101.600 4.0000	57.531 2.2650	8.0 .31	4.29 kg 9.45 lb	*854-B	190.500 7.5000	44.450 1.7500	3.3 .13	2.88 kg 6.36 lb	22.225 .8750	854-B: FLANGE ON OD FRONTFACE, BEARING WIDTH IS T1 DIMENSION	
*861V	101.600 4.0000	57.531 2.2650	8.0 .31	4.15 kg 9.16 lb	*854D	190.500 7.5000	101.600 4.0000	1.5 .06	6.28 kg 13.86 lb	127.000 5.0000	854D: GROOVE IN OD CENTER HOLES IN OD CENTER	
*861W	101.600 4.0000	57.531 2.2650	8.0 .31	4.13 kg 9.10 lb	*854DC	190.500 7.5000	101.600 4.0000	1.5 .06	6.28 kg 13.86 lb	127.000 5.0000	854DC: HOLES IN OD CENTER	
862	95.000 3.7402	57.531 2.2650	6.4 .25	4.64 kg 10.24 lb	*854V	190.500 7.5000	44.450 1.7500	3.3 .13	2.65 kg 5.85 lb	57.150 2.2500	854V: MADE FROM VACUUM MELT STEEL	
863X	100.000 3.9370	57.531 2.2650	6.0 .24	4.29 kg 9.45 lb	854X	200.025 7.8750	49.212 1.9375	3.3 .13	4.17 kg 9.19 lb	61.912 2.4375		
864	95.250 3.7500	57.531 2.2650	8.0 .31	4.60 kg 10.14 lb								
*864W	95.250 3.7500	57.531 2.2650	8.0 .31	4.47 kg 9.86 lb								
866	98.425 3.8750	57.531 2.2650	3.5 .14	4.44 kg 9.80 lb								
867A	94.976 3.7392	57.531 2.2650	3.5 .14	4.68 kg 10.32 lb								
869	87.312 3.4375	57.531 2.2650	8.0 .31	5.12 kg 11.28 lb								
NA861	101.600 4.0000	63.500 2.5000	3.5 .14	8.73 kg 19.24 lb	*854D	190.500 7.5000	101.600 4.0000	1.5 .06	6.28 kg 13.86 lb	127.000 5.0000		

855 SERIES CONTINUED ON NEXT PAGE

\*\*These Maximum Fillet Radii will be cleared by the Cone or Cup Radii.  
†Bore or O.D. shown are maximum dimensions. \* See Remarks Column.

2

CONE			Max Shaft Fillet Radii R <sup>†</sup>	Weight	CUP			Max Hs'ng Fillet Radii r <sup>†</sup>	Weight	BEAR-ING	Remarks
Number	BORE d	WIDTH B			Number	OUTSIDE DIA D	WIDTH C			WIDTH T	
<b>855 Series (cont)</b>											
					<b>*854DC</b>	190.500 7.5000	101.600 4.0000	1.5 .06	6.28 kg 13.86 lb	127.000 5.0000	
867DA	95.250 3.7500	127.000 5.0000	2.3 .09	12.47 kg 27.49 lb	852	190.500 7.5000	47.625 1.8750	3.3 .13	2.78 kg 6.12 lb	117.475 4.6250	
868D	101.600 4.0000	127.000 5.0000	1.5 .06	11.14 kg 24.56 lb	853	190.000 7.4803	48.000 1.8898	3.0 .12	2.73 kg 6.02 lb	117.175 4.6132	
					854	190.500 7.5000	44.450 1.7500	3.3 .13	2.65 kg 5.85 lb	117.475 4.6250	
					<b>*854V</b>	190.500 7.5000	44.450 1.7500	3.3 .13	2.65 kg 5.85 lb	117.475 4.6250	
					854X	200.025 7.8750	49.212 1.9375	3.3 .13	4.17 kg 9.19 lb	127.000 5.0000	
<b>895 Series</b>											
896	136.525 5.3750	57.150 2.2500	3.5 .14	5.91 kg 13.04 lb	<b>*892-B</b>	228.600 9.0000	44.450 1.7500	3.3 .13	3.42 kg 7.55 lb	22.225 .8750	892-B : FLANGE ON OD FRONTFACE, BEARING WIDTH IS T1 DIMENSION
898	139.700 5.5000	57.150 2.2500	3.5 .14	5.60 kg 12.36 lb	892	228.600 9.0000	44.450 1.7500	3.3 .13	3.07 kg 6.76 lb	57.150 2.2500	892CD : GROOVE IN OD CENTER HOLES IN OD CENTER
898A	139.700 5.5000	57.150 2.2500	6.4 .25	5.55 kg 12.25 lb	<b>*892CD</b>	228.600 9.0000	98.425 3.8750	1.5 .06	6.76 kg 14.90 lb	123.825 4.8750	
899	139.700 5.5000	58.738 2.3125	3.5 .14	5.60 kg 12.34 lb							
<b>935 Series</b>											
<b>*935A</b>	109.100 4.2953	74.000 2.9134	spcl. spcl.	6.41 kg 14.14 lb	930	206.375 8.1250	53.975 2.1250	3.3 .13	3.18 kg 7.00 lb	66.675 2.6250	935A: SPECIAL BACKFACE RADIUS
<b>*937XA</b>	109.900 4.3268	74.000 2.9134	spcl. spcl.	6.33 kg 13.96 lb	932	212.725 8.3750	53.975 2.1250	3.3 .13	4.07 kg 8.98 lb	66.675 2.6250	936W: KEYWAY IN ID
					<b>*932-B</b>	212.725 8.3750	53.975 2.1250	3.3 .13	4.44 kg 9.78 lb	23.812 .9375	937XA: SPECIAL BACKFACE RADIUS
					933	210.000 8.2677	53.975 2.1250	3.3 .13	3.72 kg 8.19 lb	67.000 2.6378	932-B: FLANGE ON OD FRONTFACE, BEARING WIDTH IS T1 DIMENSION
936	107.950 4.2500	66.675 2.6250	8.0 .31	6.34 kg 13.97 lb	930	206.375 8.1250	53.975 2.1250	3.3 .13	3.18 kg 7.00 lb	66.675 2.6250	932CD: GROOVE IN OD CENTER HOLES IN OD CENTER
<b>*936W</b>	107.950 4.2500	66.675 2.6250	8.0 .31	6.21 kg 13.68 lb	932	212.725 8.3750	53.975 2.1250	3.3 .13	4.07 kg 8.98 lb	66.675 2.6250	
938	114.300 4.5000	66.675 2.6250	7.0 .28	5.77 kg 12.73 lb	<b>*932-B</b>	212.725 8.3750	53.975 2.1250	3.3 .13	4.44 kg 9.78 lb	23.812 .9375	
938-SW	114.300 4.5000	66.675 2.6250	7.0 .28	6.00 kg 13.24 lb	<b>*932CD</b>	212.725 8.3750	117.475 4.6250	1.5 .06	8.60 kg 18.97 lb	142.875 5.6250	
938A	114.300 4.5000	66.675 2.6250	3.2 .13	5.82 kg 12.82 lb	933	210.000 8.2677	53.975 2.1250	3.3 .13	3.72 kg 8.19 lb	67.000 2.6378	
941	101.600 4.0000	66.675 2.6250	7.0 .28	6.90 kg 15.22 lb							
942	110.000 4.3307	66.675 2.6250	6.4 .25	6.18 kg 13.63 lb							
943	98.425 3.8750	66.675 2.6250	3.5 .14	7.21 kg 15.90 lb							
944A	99.974 3.9360	66.675 2.6250	3.5 .14	7.09 kg 15.62 lb							
94	111.918 4.4062	66.675 2.6250	13.5 .53	5.80 kg 12.78 lb							
NA938	114.300 4.5000	71.438 2.8125	3.5 .14	11.87 kg 26.18 lb	<b>*932CD</b>	212.725 8.3750	117.475 4.6250	1.5 .06	8.60 kg 18.97 lb	142.875 5.6250	
NA938A	114.300 4.5000	71.438 2.8125	3.5 .14	11.88 kg 26.19 lb							
946D	107.950 4.2500	152.400 6.0000	3.3 .13	16.26 kg 35.85 lb	930	206.375 8.1250	53.975 2.1250	3.3 .13	3.18 kg 7.00 lb	142.875 5.6250	
					932	212.725 8.3750	53.975 2.1250	3.3 .13	4.07 kg 8.98 lb	142.875 5.6250	
					933	210.000 8.2677	53.975 2.1250	3.3 .13	3.72 kg 8.19 lb	143.525 5.6506	

<sup>†</sup>These Maximum Fillet Radii will be cleared by the Cone or Cup Radii.  
<sup>†</sup>Bore or O.D. shown are maximum dimensions. \* See Remarks Column.

1100 – 1900 SERIES

3

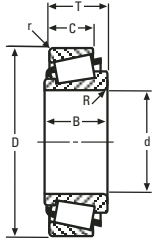

SINGLE ROW

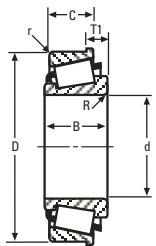

SINGLE ROW WITH FLANGE

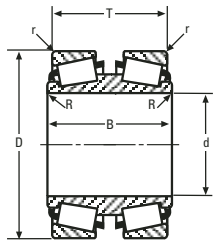

DOUBLE CONE

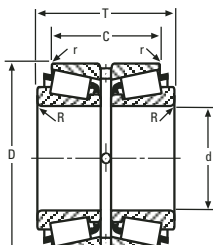

DOUBLE CUP

CONE			Max Shaft Fillet Radii R <sup>**</sup>	Weight	CUP			Max Hs'ng Fillet Radii r <sup>**</sup>	Weight	BEARING WIDTH T	Remarks
Number	BORE d	WIDTH B			Number	OUTSIDE DIA D	WIDTH C				
<b>1100 Series</b>											
1163X	14.288 .5625	22.555 .8880	1.5 .06	.12 kg .26 lb	1120NI	44.450 1.7500	14.288 .5625	1.5 .06	.05 kg .10 lb	20.637 .8125	
1178X	15.875 .6250	22.555 .8880	1.5 .06	.11 kg .25 lb	1130	44.450 1.7500	15.875 .6250	.8 .03	.05 kg .12 lb	21.875 .8612	
					1130NI	44.450 1.7500	14.288 .5625	.5 .02	.05 kg .10 lb	20.637 .8125	
<b>1200 Series</b>											
1280	22.225 .8750	22.225 .8750	.8 .03	.18 kg .40 lb	1220	57.150 2.2500	17.462 .6875	1.5 .06	.10 kg .23 lb	22.225 .8750	
<b>1300 Series</b>											
1380	22.225 .8750	20.168 .7940	1.5 .06	.14 kg .30 lb	1328	52.388 2.0625	14.288 .5625	1.5 .06	.07 kg .15 lb	19.367 .7625	1380V: MADE FROM VACUUM MELT STEEL
1380H	22.225 .8750	20.168 .7940	1.5 .06	.14 kg .30 lb	*1328-B	52.388 2.0625	14.288 .5625	1.5 .06	.08 kg .17 lb	9.042 .3560	1328-B: FLANGE ON OD FRONTFACE, BEARING WIDTH IS T1 DIMENSION
*1380V	22.225 .8750	20.168 .7940	1.5 .06	.14 kg .30 lb	*1328V	52.388 2.0625	14.288 .5625	1.5 .06	.07 kg .15 lb	19.367 .7625	1328V: MADE FROM VACUUM MELT STEEL
					328X	52.388 2.0625	14.288 .5625	1.5 .06	.07 kg .15 lb	19.367 .7625	
					1329	53.975 2.1250	14.288 .5625	1.5 .06	.08 kg .18 lb	19.367 .7625	
					1330	50.800 2.0000	15.875 .6250	1.5 .06	.06 kg .13 lb	20.002 .7875	
					1331	56.896 2.2400	14.288 .5625	.8 .03	.11 kg .24 lb	19.367 .7625	
1351	19.050 .7500	23.978 .9440	2.8 .11	.17 kg .38 lb	1351 may be paired with all single cups corresponding to 1380 and will require 3.810 mm (.1500 in) to be added to the T-width values.						
<b>1500 Series</b>											
*1551	20.638 .8125	26.010 1.0240	.3 .01	.10 kg .23 lb	1530	45.784 1.8025	15.875 .6250	.8 .03	.05 kg .11 lb	26.193 1.0312	1551: BACKFACE CHAMFER SPECIAL FRONTFACE RADIUS
<b>1600 Series</b>											
1674	31.623 1.2450	20.638 .8125	1.5 .06	.21 kg .46 lb	1620	66.675 2.6250	15.875 .6250	1.5 .06	.12 kg .26 lb	20.638 .8125	
1680	33.338 1.3125	20.638 .8125	3.5 .14	.19 kg .42 lb							
<b>1700 Series</b>											
1755	22.225 .8750	19.837 .7810	1.3 .05	-	*BB-1217	56.896 2.2400	15.875 .6250	spcl. spcl.	-	19.368 .7625	1784A: FRONTFACE CHAMFER
1774	19.004 .7482	19.837 .7810	1.5 .06	-	1729	56.896 2.2400	15.875 .6250	1.3 .05	.10 kg .22 lb	19.368 .7625	BB-1217: SPECIAL RADIUS ON BACKFACE OD SPECIAL RADIUS ON FRONTFACE OD
1775	19.050 .7500	19.837 .7810	1.5 .06	-	*1729-B	56.896 2.2400	15.875 .6250	.8 .03	.11 kg .25 lb	7.455 .2935	1729-B: FLANGE ON OD FRONTFACE, BEARING WIDTH IS T1 DIMENSION
1778	20.627 .8121	19.837 .7810	.8 .03	-	1729X	56.896 2.2400	15.875 .6250	1.5 .06	.10 kg .22 lb	19.368 .7625	
1779	23.812 .9375	19.837 .7810	.8 .03	-	1730	53.975 2.1250	15.875 .6250	.8 .03	.07 kg .15 lb	19.368 .7625	
1780	25.400 1.0000	19.837 .7810	.8 .03	-	1738X	57.150 2.2500	17.551 .6910	2.3 .09	.11 kg .25 lb	20.218 .7960	
*1784A	21.422 .8434	19.837 .7810	1.5 .06	-							
1751	23.812 .9375	24.282 .9560	.8 .03	-	1751 may be paired with all single cups corresponding to 1755 and will require 4.445 mm (.1750 in) to be added to the T-width values.						
<b>1900 Series</b>											
1975	22.225 .8750	19.355 .7620	.8 .03	.18 kg .40 lb	1920	56.896 2.2400	15.875 .6250	3.3 .13	.07 kg .15 lb	19.845 .7813	1922-B: FLANGE ON OD FRONTFACE, BEARING WIDTH IS T1 DIMENSION
1984W	28.575 1.1250	19.355 .7620	.8 .03	.14 kg .30 lb	*1922-B	57.150 2.2500	15.875 .6250	1.5 .06	.09 kg .19 lb	7.937 .3125	1931-B: FLANGE ON OD FRONTFACE, BEARING WIDTH IS T1 DIMENSION
1985	28.575 1.1250	19.355 .7620	.8 .03	.15 kg .32 lb	1922	57.150 2.2500	15.875 .6250	1.5 .06	.08 kg .17 lb	19.845 .7813	1932-B: FLANGE ON OD FRONTFACE, BEARING WIDTH IS T1 DIMENSION
1986	25.400 1.0000	19.355 .7620	1.3 .05	.17 kg .36 lb	1929	60.325 2.3750	15.080 .5937	1.5 .06	.10 kg .23 lb	19.050 .7500	

1900 SERIES CONTINUED ON NEXT PAGE

\*\*These Maximum Fillet Radii will be cleared by the Cone or Cup Radii.  
†Bore or O.D. shown are maximum dimensions. \*See Remarks Column.



3

CONE			Max Shaft Fillet Radii R''	Weight	CUP			Max Hs'ng Fillet Radii r''	Weight	BEAR-ING	Remarks
Number	BORE d	WIDTH B			Number	OUTSIDE DIA D	WIDTH C			T	
<b>1900 Series (cont)</b>											
1986W	25.400 1.0000	19.355 .7620	.8 .03	.16 kg .35 lb	1930	56.896 2.2400	15.875 .6250	.8 .03	.07 kg .16 lb	19.845 .7813	
1987	26.975 1.0620	19.355 .7620	.8 .03	.16 kg .34 lb	*1931-B	60.325 2.3750	15.875 .6250	.8 .03	.12 kg .27 lb	7.937 .3125	
1988	28.575 1.1250	19.355 .7620	3.5 .14	.14 kg .31 lb	1931	60.325 2.3750	15.875 .6250	1.3 .05	.11 kg .25 lb	19.845 .7813	
1994X	25.400 1.0000	19.355 .7620	3.5 .14	.16 kg .36 lb	*1932-B	58.738 2.3125	15.080 .5937	1.3 .05	.10 kg .22 lb	7.937 .3125	
1997X	26.988 1.0625	19.355 .7620	3.3 .13	.15 kg .33 lb	1932	58.738 2.3125	15.080 .5937	1.3 .05	.09 kg .19 lb	19.050 .7500	
1990X	23.812 .9375	21.336 .8400	3.5 .14	.19 kg .41 lb	1990X may be paired with all single cups corresponding to 1975 and will require 1.981 mm (.0780 in) to be added to the T-width values.						
<b>A2000 Series</b>											
A2031	7.938 .3125	10.785 .4246	.5 .02	.03 kg .07 lb	*A2120D	30.480 1.2000	21.260 .8370	- -	.04 kg .08 lb	25.400 1.0000	A2043: FRONTFACE CHAMFER SLOTS IN FRONTFACE NON-ADJUSTABLE CONE
A2037	9.525 .3750	10.785 .4246	1.3 .05	.03 kg .06 lb	A2126	31.991 1.2595	7.938 .3125	1.3 .05	.02 kg .04 lb	10.008 .3940	A2120D : CHAMFER ON LEFTFACE OD CHAMFER ON RIGHTFACE OD GROOVE IN OD CENTER HOLES IN OD CENTER
A2037A	9.525 .3750	10.785 .4246	1.3 .05	-	*A2126-B	31.991 1.2595	7.938 .3125	spcl. spcl.	.02 kg .05 lb	4.458 .1755	
A2047	11.986 .4719	10.785 .4246	.8 .03	.03 kg .06 lb	*A2126DB	31.991 1.2595	20.447 .8050	spcl. spcl.	.02 kg .05 lb	24.581 .9678	A2126-B : FLANGE ON OD FRONTFACE, BEARING WIDTH IS T1 DIMENSION SPECIAL RADIUS ON BACKFACE OD
A2047A	11.986 .4719	10.785 .4246	.8 .03	-	*A2127	31.991 1.2595	9.538 .3755	1.3 .05	.02 kg .04 lb	10.567 .4160	
*A2043	11.112 .4375	14.351 .5650	.8 .03	.03 kg .07 lb	*A2120D	30.480 1.2000	21.260 .8370	- -	.04 kg .08 lb	29.306 1.1538	A2126DB : FLANGE ON OD CENTER HOLES IN CENTER FLANGE SPECIAL RADIUS ON LEFTFACE OD
					K103256	38.100 1.5000	26.988 1.0625	1.3 .05	.12 kg .27 lb	28.578 1.1251	SPECIAL RADIUS ON RIGHTFACE OD
					*K312469	40.005 1.5750	26.988 1.0625	1.3 .05	.15 kg .34 lb	28.578 1.1251	A2127 : SHOULDER ON ID FRONTFACE K312469: BROKEN CORNER ON LEFTFACE OD FLANGE ON OD LEFTFACE
<b>2300 Series</b>											
2380	22.225 .8750	24.765 .9750	.8 .03	.21 kg .47 lb	2320	56.896 2.2400	20.638 .8125	3.3 .13	.09 kg .20 lb	23.812 .9375	
2381	23.812 .9375	24.765 .9750	2.3 .09	.20 kg .44 lb	2330	56.896 2.2400	20.638 .8125	.8 .03	.10 kg .21 lb	23.812 .9375	
2382	25.400 1.0000	24.765 .9750	.8 .03	.19 kg .42 lb							
2356	25.400 1.0000	34.290 1.3500	3.5 .14	.24 kg .53 lb	2356 may be paired with all single cups corresponding to 2380 and will require 9.525 mm (.3750 in) to be added to the T-width values.						
<b>2400 Series</b>											
2473	25.400 1.0000	23.812 .9375	.8 .03	.30 kg .65 lb	2420	68.262 2.6875	17.462 .6875	1.5 .06	.14 kg .31 lb	22.225 .8750	
2473X	25.400 1.0000	23.812 .9375	2.3 .09	.29 kg .65 lb							
2474	28.575 1.1250	23.812 .9375	.8 .03	.27 kg .60 lb							
2475	31.750 1.2500	23.812 .9375	3.5 .14	.24 kg .52 lb							
<b>2500 Series</b>											
2558	30.162 1.1875	25.357 .9983	2.3 .09	.30 kg .66 lb	2520	66.421 2.6150	20.638 .8125	3.3 .13	.12 kg .26 lb	25.400 1.0000	2553: EXTENDED LARGE RIB
2559	30.162 1.1875	25.357 .9983	.8 .03	.30 kg .66 lb	2520A	66.421 2.6150	20.638 .8125	1.5 .06	.13 kg .28 lb	25.400 1.0000	2554: EXTENDED LARGE RIB
2560X	30.000 1.1811	25.357 .9983	2.0 .08	.30 kg .66 lb	2522X	66.675 2.6250	20.638 .8125	3.3 .13	.12 kg .27 lb	25.400 1.0000	2557T: EXTENDED LARGE RIB TAPERED BORE
2561X	30.213 1.1895	24.714 .9730	2.3 .09	.29 kg .65 lb	2523	69.850 2.7500	19.050 .7500	1.3 .05	.17 kg .37 lb	23.813 .9375	2581T: TAPERED BORE
2578	28.575 1.1250	25.357 .9983	2.3 .09	.31 kg .69 lb	*2523-B	69.850 2.7500	19.050 .7500	1.5 .06	.18 kg .40 lb	8.725 .3435	2583T: TAPERED BORE

\*\*These Maximum Fillet Radii will be cleared by the Cone or Cup Radii.  
†Bore or O.D. shown are maximum dimensions. \*See Remarks Column.

2500 – 2700 SERIES

3

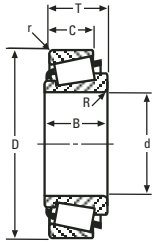

SINGLE ROW



SINGLE ROW WITH FLANGE

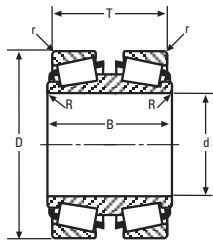

DOUBLE CONE

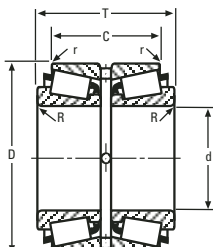

DOUBLE CUP

CONE				Weight	CUP			Max Hs'ng Fillet Radii r''	Weight	BEARING		Remarks
Number	BORE d	WIDTH B	Max Shaft Fillet Radii R''		Number	OUTSIDE DIA D	WIDTH C			WIDTH T		
<b>2500 Series (cont)</b>												
2580	31.750 1.2500	25.357 .9983	.8 .03	.28 kg .63 lb	*2523D	69.850 2.7500	57.150 2.2500	.8 .03	.57 kg 1.25 lb	66.675 2.6250	2584: EXTENDED LARGE RIB	
2580A	31.750 1.2500	25.357 .9983	1.3 .05	.28 kg .63 lb	2523-S	69.850 2.7500	19.050 .7500	1.5 .06	.17 kg .37 lb	23.813 .9375	2523-B: FLANGE ON OD FRONTFACE, BEARING WIDTH IS T1 DIMENSION	
2580W	31.750 1.2500	25.357 .9983	.8 .03	.28 kg .62 lb	2524YD	69.850 2.7500	57.150 2.2500	.8 .03	.57 kg 1.25 lb	66.675 2.6250	2523D: GROOVE IN OD CENTER HOLES IN OD CENTER	
2581	33.338 1.3125	25.357 .9983	.8 .03	.27 kg .59 lb	2525	72.022 2.8355	19.050 .7500	.8 .03	.20 kg .45 lb	23.813 .9375		
*2581T	33.338 1.3125	25.357 .9983	.8 .03	.28 kg .61 lb	2526X	72.000 2.8346	19.050 .7500	2.0 .08	.20 kg .45 lb	23.813 .9375		
2582	31.750 1.2500	25.357 .9983	3.5 .14	.28 kg .62 lb	2530	66.421 2.6150	20.638 .8125	.8 .03	.13 kg .28 lb	25.400 1.0000		
*2583T	30.162 1.1875	25.357 .9983	1.5 .06	.29 kg .65 lb								
2585	33.338 1.3125	25.357 .9983	3.5 .14	.26 kg .58 lb								
2586	30.000 1.1811	25.357 .9983	3.5 .14	.30 kg .65 lb								
*2553	31.750 1.2500	30.912 1.2170	3.5 .14	.33 kg .72 lb	2553 and grouped cones may be paired with all single cups corresponding to 2558 and will require 5.555 mm (.2187 in) to be added to the T-width values.							
*2554	33.338 1.3125	30.912 1.2170	3.5 .14	.31 kg .67 lb	2553 and grouped cones may be paired with all double cups corresponding to 2558 and will require 11.110 mm (.4374 in) to be added to the T-width values.							
*2557T	30.955 1.2187	30.912 1.2170	3.4 .13	.33 kg .72 lb								
*2584	32.532 1.2808	26.944 1.0608	5.0 .20	.28 kg .61 lb	2584 may be paired with all single cups corresponding to 2558 and will require 1.588 mm (.0625 in) to be added to the T-width values. 2584 may be paired with all double cups corresponding to 2558 and will require 3.175 mm (.1250 in) to be added to the T-width values.							
<b>2600 Series</b>												
2681	27.200 1.0709	25.433 1.0013	.3 .01	.26 kg .58 lb	2620	63.100 2.4843	19.050 .7500	3.3 .13	.11 kg .23 lb	23.812 .9375	2683: FRONTFACE CHAMFER	
2682	26.162 1.0300	25.433 1.0013	1.5 .06	.27 kg .60 lb	2630	63.100 2.4843	19.050 .7500	.8 .03	.11 kg .25 lb	23.812 .9375	2688T: TAPERED BORE 2631-B: FLANGE ON OD FRONTFACE, BEARING WIDTH IS T1 DIMENSION SPECIAL RADIUS ON BACKFACE OD	
*2683	23.812 .9375	25.433 1.0013	.8 .03	.29 kg .63 lb	*2631-B	66.421 2.6150	19.050 .7500	.8 .03	.17 kg .38 lb	8.725 .3435		
2684	22.225 .8750	25.433 1.0013	1.5 .06	.30 kg .66 lb	2631	66.421 2.6150	19.050 .7500	1.3 .05	.16 kg .36 lb	23.812 .9375	2632DB: FLANGE ON OD CENTER KEYWAY IN OD SURFACE SPECIAL RADIUS ON LEFT FACE OD	
2685	23.812 .9375	25.433 1.0013	.8 .03	.29 kg .64 lb	*2632DB	63.500 2.5000	60.325 2.3750	.8 .03	.62 kg 1.37 lb	69.849 2.7500	SPECIAL RADIUS ON RIGHTFACE OD	
2687	25.400 1.0000	25.433 1.0013	1.3 .05	.28 kg .61 lb	2633X	62.000 2.4409	19.050 .7500	3.0 .12	.09 kg .20 lb	23.812 .9375		
2688	26.988 1.0625	25.433 1.0013	1.5 .06	.26 kg .58 lb								
*2688T	26.988 1.0625	25.433 1.0013	1.5 .06	.26 kg .58 lb								
2689	28.575 1.1250	25.433 1.0013	1.3 .05	.25 kg .55 lb								
2689A	28.575 1.1250	24.790 .9760	1.3 .05	.25 kg .55 lb								
2690	29.367 1.1562	25.433 1.0013	3.5 .14	.24 kg .53 lb								
2691	29.367 1.1562	25.433 1.0013	.8 .03	.24 kg .54 lb								
<b>2700 Series</b>												
2775	34.976 1.3770	25.654 1.0100	1.5 .06	- -	*2720-B	76.200 3.0000	19.050 .7500	3.3 .13	.23 kg .51 lb	11.112 .4375	2787T: TAPERED BORE	
2776	38.100 1.5000	25.654 1.0100	4.3 .17	- -	2720	76.200 3.0000	19.050 .7500	3.3 .13	.18 kg .40 lb	23.775 .9360	2798T: TAPERED BORE	
2777	38.100 1.5000	25.654 1.0100	5.5 .22	- -	2726	73.025 2.8750	19.050 .7500	3.3 .13	.13 kg .28 lb	23.775 .9360	2720-B: FLANGE ON OD FRONTFACE, BEARING WIDTH IS T1 DIMENSION	

2700 SERIES CONTINUED ON NEXT PAGE

\*\*These Maximum Fillet Radii will be cleared by the Cone or Cup Radii.  
†Bore or O.D. shown are maximum dimensions. \*See Remarks Column.

2700 – JRM3000 SERIES

3

CONE			Max Shaft Fillet Radii R''	Weight	CUP			Max Hs'ng Fillet Radii r''	Weight	BEAR-ING	Remarks
Number	BORE d	WIDTH B			Number	OUTSIDE DIA D	WIDTH C			WIDTH T	
<b>2700 Series (cont)</b>											
2780	36.487 1.4365	25.654 1.0100	1.5 .06	-	2729X	76.200 3.0000	19.050 .7500	1.5 .06	19 kg .41 lb	23.775 .9360	
2783	31.750 1.2500	25.654 1.0100	1.5 .06	-	2729	76.200 3.0000	19.050 .7500	.8 .03	19 kg .42 lb	23.775 .9360	
2785	33.338 1.3125	25.654 1.0100	3.5 .14	-	2731	79.375 3.1250	19.050 .7500	3.3 .13	24 kg .52 lb	23.775 .9360	
2785W	33.338 1.3125	25.654 1.0100	3.5 .14	-	2732	79.375 3.1250	24.608 .9688	.8 .03	34 kg .75 lb	29.333 1.1548	
2786	34.925 1.3750	25.654 1.0100	5.0 .20	-	2733	75.260 2.9630	19.050 .7500	3.3 .13	16 kg .36 lb	23.775 .9360	
*2787T	34.925 1.3750	25.654 1.0100	1.5 .06	-	2734	79.375 3.1250	20.638 .8125	3.3 .13	26 kg .58 lb	25.363 .9985	
2788	38.100 1.5000	25.654 1.0100	3.5 .14	-	2735X	73.025 2.8750	19.050 .7500	.8 .03	13 kg .29 lb	23.775 .9360	
2788A	38.100 1.5000	25.654 1.0100	1.5 .06	-	2736	74.612 2.9375	19.050 .7500	.8 .03	16 kg .36 lb	23.775 .9360	
2788W	38.100 1.5000	25.654 1.0100	3.5 .14	-							
2789	39.688 1.5625	25.654 1.0100	3.5 .14	-							
2790	33.338 1.3125	25.654 1.0100	1.5 .06	-							
2791A	35.707 1.4058	25.654 1.0100	1.5 .06	-							
2793	34.925 1.3750	25.654 1.0100	.8 .03	-							
2794	36.487 1.4365	25.654 1.0100	3.5 .14	-							
2796	34.925 1.3750	25.654 1.0100	3.5 .14	-							
*2798T	37.732 1.4855	25.654 1.0100	1.5 .06	-							
2799W	38.100 1.5000	25.654 1.0100	3.5 .14	-							
<b>2800 Series</b>											
2875	31.750 1.2500	23.812 .9375	3.5 .14	.32 kg .70 lb	2820	73.025 2.8750	17.462 .6875	3.3 .13	.14 kg .32 lb	22.225 .8750	
2876	33.338 1.3125	23.812 .9375	3.5 .14	.30 kg .66 lb	2821	73.025 2.8750	17.462 .6875	.8 .03	.15 kg .34 lb	22.225 .8750	
2877	34.925 1.3750	23.812 .9375	3.5 .14	.29 kg .63 lb							
2878	34.925 1.3750	23.812 .9375	.8 .03	.29 kg .64 lb							
2879	31.750 1.2500	23.812 .9375	.8 .03	.32 kg .71 lb							
2880	35.306 1.3900	23.812 .9375	3.5 .14	.28 kg .62 lb							
<b>2900 Series</b>											
2973	42.862 1.6875	25.608 1.0082	3.5 .14	.44 kg .97 lb	*2924-B	85.000 3.3465	20.638 .8125	1.3 .05	.26 kg .58 lb	9.525 .3750	2924-B : FLANGE ON OD FRONTFACE, BEARING WIDTH IS T1 DIMENSION SPECIAL RADIUS ON BACKFACE OD
2975	44.450 1.7500	25.608 1.0082	3.5 .14	.42 kg .92 lb	2924	85.000 3.3465	20.638 .8125	1.3 .05	.22 kg .48 lb	25.400 1.0000	
2984	46.038 1.8125	25.608 1.0082	3.5 .14	.39 kg .87 lb	2925	87.312 3.4375	22.225 .8750	2.3 .09	.29 kg .65 lb	26.987 1.0625	
2984A	46.038 1.8125	25.608 1.0082	.8 .03	.40 kg .88 lb							
<b>A3000 Series</b>											
A3044	SEE MULTI-ROW STEERING GEAR BEARING SECTION										
A3045											
<b>JRM3000 Series</b>											
JRM3049	30.000 1.1811	19.5072 .768	2.54 .1	-	JRM3010XDA	SEE UNIPAC BEARING SECTION					

\*\*These Maximum Fillet Radii will be cleared by the Cone or Cup Radii.  
†Bore or O.D. shown are maximum dimensions. \*See Remarks Column.

3100 – 3400 SERIES

3

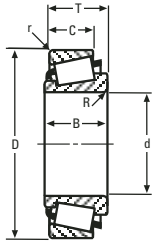

SINGLE ROW

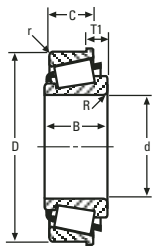

SINGLE ROW WITH FLANGE

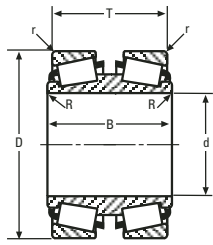

DOUBLE CONE

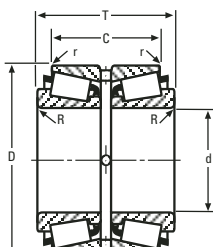

DOUBLE CUP

CONE				Weight	CUP			Weight	BEARING		Remarks
Number	BORE d	WIDTH B	Max Shaft Fillet Radii R <sup>**</sup>		Number	OUTSIDE DIA D	WIDTH C		Max Hs'ng Fillet Radii r <sup>**</sup>	WIDTH T	
<b>3100 Series</b>											
3187	30.162 1.1875	29.997 1.1810	.8 .03	.38 kg .85 lb	*3120-B	72.626 2.8593	23.812 .9375	3.3 .13	.24 kg .53 lb	11.112 .4375	3162: BROKEN BACKFACE ID 3196: FRONTFACE CHAMFER
3188	31.750 1.2500	29.997 1.1810	.8 .03	.37 kg .81 lb	3120-S	72.000 2.8346	23.812 .9375	3.3 .13	.20 kg .45 lb	30.162 1.1875	
3188-S	31.750 1.2500	29.997 1.1810	1.5 .06	.36 kg .80 lb	3120	72.626 2.8593	23.812 .9375	3.3 .13	.22 kg .48 lb	30.162 1.1875	3120-B: BEARING WIDTH IS T1 DIMENSION
3189	25.400 1.0000	29.997 1.1810	.8 .03	.43 kg .95 lb	3126	72.034 2.8360	23.812 .9375	2.8 .11	.21 kg .46 lb	30.162 1.1875	
3190	30.000 1.1811	29.997 1.1810	3.5 .14	.38 kg .84 lb	3129	76.200 3.0000	23.812 .9375	.8 .03	.30 kg .67 lb	30.162 1.1875	
319	30.162 1.1875	29.997 1.1810	3.5 .14	.38 kg .84 lb	3130	72.626 2.8593	23.812 .9375	.8 .03	.23 kg .50 lb	30.162 1.1875	
3192	28.575 1.1250	29.997 1.1810	3.5 .14	.40 kg .87 lb							
3193	31.750 1.2500	29.997 1.1810	3.5 .14	.36 kg .80 lb							
*3196	33.338 1.3125	29.997 1.1810	3.5 .14	.34 kg .75 lb							
3197	33.338 1.3125	29.997 1.1810	.8 .03	.35 kg .76 lb							
3198	28.575 1.1250	29.997 1.1810	1.3 .05	.40 kg .88 lb							
3199	31.750 1.2500	29.997 1.1810	2.3 .09	.36 kg .80 lb							
*3162	23.812 .9375	39.573 1.5580	.3 .01	.56 kg 1.24 lb	3162 may be paired with all single cups corresponding to 3187 and will require 9.576 mm (.3770 in) to be added to the T-width values.						
<b>3300 Series</b>											
3378	36.487 1.4365	30.391 1.1965	3.5 .14	.49 kg 1.08 lb	3320	80.167 3.1562	23.812 .9375	3.3 .13	.21 kg .46 lb	29.370 1.1563	3353: BROKEN BACKFACE ID
3379	34.925 1.3750	30.391 1.1965	3.5 .14	.51 kg 1.13 lb	*3320-B	80.167 3.1562	23.812 .9375	3.3 .13	.27 kg .60 lb	10.320 .4063	3381-SW: SLOTS IN BACKFACE
3381	38.100 1.5000	30.391 1.1965	3.5 .14	.47 kg 1.03 lb	3320X	85.725 3.3750	23.812 .9375	3.3 .13	.30 kg .66 lb	23.384 .9206	3382T: TAPERED BORE
*3381-SW	38.100 1.5000	30.391 1.1965	3.5 .14	.46 kg 1.01 lb	3321	77.534 3.0525	23.812 .9375	3.3 .13	.17 kg .36 lb	29.370 1.1563	3320-B: FLANGE ON OD FRONTFACE, BEARING WIDTH IS T1 DIMENSION
3382	39.688 1.5625	30.391 1.1965	3.5 .14	.45 kg .98 lb	3324	80.167 3.1562	21.430 .8437	3.3 .13	.18 kg .40 lb	26.987 1.0625	3329-B: FLANGE ON OD FRONTFACE, BEARING WIDTH IS T1 DIMENSION
*3382T	39.688 1.5625	30.391 1.1965	3.3 .13	.45 kg .99 lb	3325	79.974 3.1486	23.812 .9375	3.3 .13	.20 kg .45 lb	29.370 1.1563	
3383	41.275 1.6250	30.391 1.1965	3.5 .14	.42 kg .93 lb	3328	84.138 3.3125	23.812 .9375	3.3 .13	.30 kg .67 lb	29.370 1.1563	
3384	41.275 1.6250	30.391 1.1965	.8 .03	.43 kg .94 lb	3329	81.755 3.2187	23.812 .9375	3.3 .13	.25 kg .54 lb	29.370 1.1563	
3386	39.688 1.5625	30.391 1.1965	.8 .03	.45 kg 1.00 lb	*3329-B	81.755 3.2187	23.812 .9375	3.3 .13	.29 kg .64 lb	10.320 .4063	
3387	38.100 1.5000	30.391 1.1965	.8 .03	.48 kg 1.05 lb	3331	80.167 3.1562	23.812 .9375	.8 .03	.22 kg .48 lb	29.370 1.1563	
					3339	80.035 3.1510	23.812 .9375	1.5 .06	.21 kg .47 lb	29.370 1.1563	
*3353	36.512 1.4375	38.329 1.5090	.3 .01	.60 kg 1.31 lb	3353 and grouped cones may be paired with all single cups corresponding to 3378 and will require 7.938 mm (.3125 in) to be added to the T-width values.						
3360	34.925 1.3750	38.329 1.5090	3.5 .14	.62 kg 1.36 lb							
3360A	34.925 1.3750	38.329 1.5090	3.5 .14	.62 kg 1.38 lb							
336	38.100 1.5000	38.329 1.5090	3.5 .14	.56 kg 1.24 lb							
<b>3400 Series</b>											
3474	30.162 1.1875	29.771 1.1721	.8 .03	.51 kg 1.12 lb	*3420-B	79.375 3.1250	23.812 .9375	3.3 .13	.28 kg .61 lb	10.320 .4063	3476-SW: SLOTS IN BACKFACE
3476	31.750 1.2500	29.771 1.1721	1.3 .05	.49 kg 1.08 lb	3420	79.375 3.1250	23.812 .9375	3.3 .13	.25 kg .56 lb	29.370 1.1563	3476X: FRONTFACE CHAMFER 3478: FRONTFACE CHAMFER

3400 SERIES CONTINUED ON NEXT PAGE

\*\*These Maximum Fillet Radii will be cleared by the Cone or Cup Radii.  
†Bore or O.D. shown are maximum dimensions. \*See Remarks Column.

3

CONE			Max Shaft Fillet Radii R''	Weight	CUP			Max Hs'ng Fillet Radii r''	Weight	BEAR-ING	Remarks
Number	BORE d	WIDTH B			Number	OUTSIDE DIA D	WIDTH C			WIDTH T	
<b>3400 Series (cont)</b>											
*3476-SW	31.750 1.2500	29.771 1.1721	1.3 .05	.49 kg 1.09 lb	3422	80.167 3.1562	23.812 .9375	3.3 .13	.27 kg .60 lb	29.370 1.1563	3479X: FRONTFACE CHAMFER
*3476X	31.750 1.2500	29.771 1.1721	1.5 .06	.49 kg 1.08 lb	*3423D	82.550 3.2500	55.562 2.1875	.8 .03	.82 kg 1.81 lb	66.678 2.6251	3490: FRONTFACE CHAMFER
3477	33.338 1.3125	29.771 1.1721	3.5 .14	.47 kg 1.03 lb	*3424YD	82.550 3.2500	55.562 2.1875	.8 .03	.82 kg 1.81 lb	66.678 2.6251	3420-B : FLANGE ON OD FRONTFACE, BEARING WIDTH IS T1 DIMENSION
*3478	34.925 1.3750	29.771 1.1721	3.5 .14	.45 kg .99 lb	3426	79.324 3.1230	23.812 .9375	3.3 .13	.25 kg .55 lb	29.370 1.1563	SPECIAL RADIUS ON BACKFACE OD SPECIAL RADIUS ON FRONTFACE OD
3479	36.512 1.4375	29.771 1.1721	.8 .03	.43 kg .95 lb	3431	82.550 3.2500	23.812 .9375	3.3 .13	.33 kg .72 lb	29.370 1.1563	3423D : GROOVE IN OD CENTER HOLES IN OD CENTER
*3479X	36.512 1.4375	29.771 1.1721	3.5 .14	.43 kg .94 lb							
3480	35.000 1.3780	29.771 1.1721	1.5 .06	.45 kg .99 lb							3424YD : HOLES IN OD CENTER
3482	34.925 1.3750	29.771 1.1721	.8 .03	.45 kg 1.00 lb							
3483	33.338 1.3125	29.771 1.1721	.8 .03	.47 kg 1.04 lb							
*3490	38.100 1.5000	29.771 1.1721	3.5 .14	.40 kg .89 lb							
<b>JRM3400 Series</b>											
JRM3449	34.000 1.3386	19.5072 0.768	2.54 0.1	- -	JRM3410XD	SEE UNIPAC BEARING SECTION					
<b>3500 Series</b>											
*3575T	39.688 1.5625	30.886 1.2160	1.5 .06	.56 kg 1.23 lb	3520	84.138 3.3125	23.812 .9375	3.3 .13	.22 kg .48 lb	30.163 1.1875	3575T TAPERED BORE
3576	41.275 1.6250	30.886 1.2160	.8 .03	.53 kg 1.17 lb	*3520V	84.138 3.3125	23.812 .9375	3.3 .13	.22 kg .48 lb	30.163 1.1875	3586V: MADE FROM VACUUM MELT STEEL
3577	41.275 1.6250	30.886 1.2160	3.5 .14	.53 kg 1.16 lb	3521	86.284 3.3970	23.812 .9375	3.3 .13	.27 kg .60 lb	30.163 1.1875	3520V: MADE FROM VACUUM MELT STEEL
3578	44.450 1.7500	30.886 1.2160	3.5 .14	.47 kg 1.05 lb	3525	87.312 3.4375	23.812 .9375	3.3 .13	.30 kg .65 lb	30.163 1.1875	3525-B : FLANGE ON OD FRONTFACE, BEARING WIDTH IS T1 DIMENSION
3578A	44.450 1.7500	30.886 1.2160	5.5 .22	.46 kg 1.02 lb	*3525-B	87.312 3.4375	23.812 .9375	spcl. spcl.	.33 kg .72 lb	11.100 .4370	SPECIAL RADIUS ON BACKFACE OD SPECIAL RADIUS ON FRONTFACE OD
3578AA	44.450 1.7500	30.886 1.2160	.5 .02	.48 kg 1.06 lb	3526	87.312 3.4375	23.812 .9375	.8 .03	.31 kg .68 lb	30.163 1.1875	
3579	42.862 1.6875	30.886 1.2160	3.5 .14	.50 kg 1.10 lb	3530	84.138 3.3125	23.812 .9375	.8 .03	.23 kg .50 lb	30.163 1.1875	
3580	38.100 1.5000	30.886 1.2160	1.5 .06	.58 kg 1.28 lb							
3581	34.925 1.3750	30.886 1.2160	3.5 .14	.62 kg 1.36 lb							
3582	40.000 1.5748	30.886 1.2160	3.5 .14	.55 kg 1.20 lb							
3583	38.100 1.5000	30.886 1.2160	3.5 .14	.57 kg 1.27 lb							
3585	41.275 1.6250	30.886 1.2160	1.5 .06	.53 kg 1.17 lb							
3586	45.237 1.7810	30.886 1.2160	3.5 .14	.46 kg 1.02 lb							
*3586V	45.237 1.7810	30.886 1.2160	3.5 .14	.46 kg 1.02 lb							
<b>JRM3500 Series</b>											
JRM3534	34.000 1.3386	18.500 0.7284	N/A N/A	- -	JRM3564XD	SEE UNIPAC BEARING SECTION					
JRM3535	35.000 1.3780	18.500 0.7284	3.5 0.14	- -							
JRM3535H	35.000 1.3780	18.500 0.7284	3.5 0.14	- -							
JRM3535X	35.000 1.3780	18.500 0.7284	3.5 0.14	- -							
JRM3535XA	35.000 1.3780	18.500 0.7284	3.5 0.14	- -							
JRM3536	35.000 1.3780	18.500 0.7284	3.5 0.14	- -							

\*These Maximum Fillet Radii will be cleared by the Cone or Cup Radii.  
†Bore or O.D. shown are maximum dimensions. \*See Remarks Column.

JRM3500 – 3700 SERIES

3

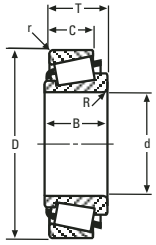

SINGLE ROW

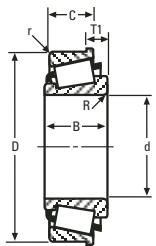

SINGLE ROW WITH FLANGE

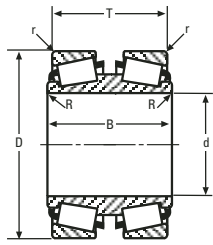

DOUBLE CONE

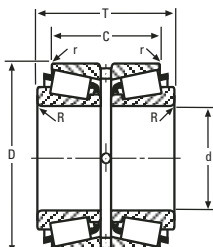

DOUBLE CUP

CONE			Max Shaft Fillet Radii R <sup>**</sup>	Weight	CUP			Max H's'ng Fillet Radii r <sup>**</sup>	Weight	BEARING WIDTH T	Remarks
Number	BORE d	WIDTH B			Number	OUTSIDE DIA D	WIDTH C				
JRM3500 Series (cont)											
JRM3535A	35.000 1.3780	17.500 .6890	1.8 .07	- -	JRM3565XD	SEE UNIPAC BEARING SECTION					
JS-3500 Series											
†JS-3549A	35.000 1.3780	23.500 .9252	2.0 .08	.26 kg .58 lb	†JS-3510	70.000 2.7559	19.000 .7480	1.5 .06	.16 kg .34 lb	24.000 .9449	
3600 Series											
3659	23.812 .9375	30.416 1.1975	2.3 .09	.29 kg .65 lb	*3620-B	61.912 2.4375	23.812 .9375	3.3 .13	.17 kg .37 lb	9.525 .3750	3655: BROKEN BACKFACE ID 3620-B : FLANGE ON OD FRONTFACE, BEARING WIDTH IS T1 DIMENSION SPECIAL RADIUS ON BACKFACE OD SPECIAL RADIUS ON FRONTFACE OD
3660	20.638 .8125	30.416 1.1975	2.3 .09	.32 kg .71 lb	3620	61.912 2.4375	23.812 .9375	3.3 .13	.15 kg .32 lb	28.575 1.1250	
*3655	22.225 .8750	38.354 1.5100	.3 .01	.37 kg .81 lb	3655 may be paired with all single cups corresponding to 3659 and will require 7.938 mm (.3125 in) to be added to the T-width values.						
3700 Series											
3767	52.388 2.0625	30.302 1.1930	2.3 .09	.53 kg 1.18 lb	373	100.000 3.9370	25.000 .9842	2.0 .08	.47 kg 1.05 lb	28.173 1.1092	3750T: EXTENDED LARGE RIB TAPERED BORE
3767A	52.388 2.0625	30.302 1.1930	2.3 .09	.53 kg 1.17 lb	3720	93.264 3.6718	23.812 .9375	3.3 .13	.28 kg .62 lb	30.163 1.1875	3751: BROKEN BACKFACE ID EXTENDED LARGE RIB
3767AA	52.388 2.0625	30.302 1.1930	4.5 .18	.54 kg 1.19 lb	*3720-B	93.264 3.6718	23.812 .9375	3.3 .13	.32 kg .70 lb	11.112 .4375	3753: BROKEN BACKFACE ID EXTENDED LARGE RIB
3767W	52.388 2.0625	30.302 1.1930	2.3 .09	.53 kg 1.16 lb	*3720V	93.264 3.6718	23.812 .9375	3.3 .13	.28 kg .62 lb	30.163 1.1875	
3774	39.688 1.5625	30.302 1.1930	3.5 .14	.75 kg 1.65 lb	3726	95.250 3.7500	23.812 .9375	3.3 .13	.34 kg .74 lb	30.163 1.1875	3760: EXTENDED LARGE RIB
3775	50.800 2.0000	30.302 1.1930	.8 .03	.57 kg 1.25 lb	3727	93.662 3.6875	23.812 .9375	3.3 .13	.29 kg .65 lb	30.163 1.1875	3762: EXTENDED LARGE RIB
3776	44.983 1.7710	30.302 1.1930	3.5 .14	.66 kg 1.46 lb	*3729D	93.264 3.6718	52.388 2.0625	.8 .03	.68 kg 1.49 lb	65.088 2.5625	3780V: MADE FROM VACUUM MELT STEEL
3777	46.038 1.8125	30.302 1.1930	3.5 .14	.65 kg 1.42 lb	*3729DC	93.264 3.6718	52.388 2.0625	.8 .03	.68 kg 1.49 lb	65.088 2.5625	NA3780-SW: FRONTFACE CHAMFER SLOTS IN FRONTFACE
3778	47.625 1.8750	30.302 1.1930	6.4 .25	.60 kg 1.32 lb	3730	93.264 3.6718	23.812 .9375	.8 .03	.29 kg .65 lb	30.163 1.1875	3795: SPECIAL FRONTFACE RADIUS
3779	47.625 1.8750	30.302 1.1930	3.5 .14	.62 kg 1.36 lb	3731	99.979 3.9362	23.812 .9375	3.3 .13	.47 kg 1.04 lb	30.163 1.1875	3720-B: FLANGE ON OD FRONTFACE, BEARING WIDTH IS T1 DIMENSION
3780	50.800 2.0000	30.302 1.1930	3.5 .14	.56 kg 1.23 lb	3732	98.425 3.8750	23.812 .9375	3.3 .13	.43 kg .94 lb	30.163 1.1875	3720V : MADE FROM VACUUM MELT STEEL
*3780V	50.800 2.0000	30.302 1.1930	3.5 .14	.56 kg 1.23 lb	3733	100.038 3.9385	23.812 .9375	.8 .03	.49 kg 1.07 lb	30.163 1.1875	3729D : GROOVE IN OD CENTER HOLES IN OD CENTER
3780W	50.800 2.0000	30.302 1.1930	3.5 .14	.56 kg 1.23 lb	3735	100.040 3.9386	23.812 .9375	3.3 .13	.47 kg 1.04 lb	30.100 1.1850	
3781	49.212 1.9375	30.302 1.1930	3.5 .14	.59 kg 1.30 lb							3729DC: HOLES IN OD CENTER
3781A	48.412 1.9060	30.302 1.1930	3.5 .14	.60 kg 1.33 lb							
3782	44.450 1.7500	30.302 1.1930	3.5 .14	.67 kg 1.48 lb							
3783	44.450 1.7500	30.302 1.1930	6.4 .25	.66 kg 1.45 lb							
3784	50.800 2.0000	30.302 1.1930	6.4 .25	.54 kg 1.19 lb							
*3795	50.800 2.0000	30.302 1.1930	3.5 .14	.55 kg 1.22 lb							
*3750T	50.005 1.9687	36.652 1.4430	4.9 .19	.70 kg 1.54 lb	3750T and grouped cones may be paired with all single cups corresponding to 3767 and will require 6.350 mm (.2500 in) to be added to the T-width values.						
*3751	34.925 1.3750	36.652 1.4430	.3 .01	.97 kg 2.14 lb	3750T and grouped cones may be paired with all double cups corresponding to 3767 and will require 12.700 mm (.5000 in) to be added to the T-width values.						
*3753	41.275 1.6250	36.652 1.4430	.3 .01	.86 kg 1.90 lb							
*3760	44.450 1.7500	36.652 1.4430	3.5 .14	.79 kg 1.75 lb							

3700 SERIES CONTINUED ON NEXT PAGE

\*\*These Maximum Fillet Radii will be cleared by the Cone or Cup Radii.  
†Bore or O.D. shown are maximum dimensions. \*See Remarks Column.

3

CONE			Max Shaft Fillet Radii R <sup>**</sup>	Weight	CUP			Max Hs'ng Fillet Radii r <sup>**</sup>	Weight	BEAR-ING	Remarks	
Number	BORE d	WIDTH B			Number	OUTSIDE DIA D	WIDTH C			WIDTH T		
<b>3700 Series (cont)</b>												
*3762	50.800 2.0000	36.652 1.4430	3.5 .14	.66 kg 1.45 lb								
NA3780	50.800 2.0000	32.542 1.2812	3.5 .14	1.15 kg 2.54 lb	*3729D	93.264 3.6718	52.388 2.0625	.8 .03	.68 kg 1.49 lb	65.085 2.5624		
*NA3780-SW	50.800 2.0000	32.542 1.2812	3.5 .14	1.14 kg 2.51 lb	*3729DC	93.264 3.6718	52.388 2.0625	.8 .03	.68 kg 1.49 lb	65.085 2.5624		
<b>3800 Series</b>												
3872	34.925 1.3750	30.162 1.1875	3.5 .14	.64 kg 1.41 lb	3820	85.725 3.3750	23.812 .9375	3.3 .13	.28 kg .61 lb	30.163 1.1875	3820-B: FLANGE ON OD FRONTFACE, BEARING WIDTH IS T1 DIMENSION SPECIAL RADIUS ON BACKFACE OD SPECIAL RADIUS ON FRONTFACE OD  3820W: KEYWAY BACKFACE 3822RB: GROOVE IN OD FRONTFACE	
3872A	34.925 1.3750	30.162 1.1875	.8 .03	.64 kg 1.42 lb	*3820-B	85.725 3.3750	23.812 .9375	spcl. spcl.	.30 kg .66 lb	11.112 .4375		
3875	38.100 1.5000	30.162 1.1875	.8 .03	.60 kg 1.33 lb	*3820W	85.725 3.3750	23.812 .9375	3.3 .13	.29 kg .63 lb	30.163 1.1875		
3876	38.100 1.5000	30.162 1.1875	3.5 .14	.60 kg 1.31 lb	3821	85.725 3.3750	23.812 .9375	1.3 .05	.29 kg .63 lb	30.163 1.1875		
3877	41.275 1.6250	30.162 1.1875	3.5 .14	.55 kg 1.21 lb	*3822RB	88.108 3.4688	23.812 .9375	3.3 .13	.35 kg .76 lb	30.163 1.1875		
3877A	41.275 1.6250	30.162 1.1875	2.2 .09	.55 kg 1.22 lb								
3878	36.512 1.4375	30.162 1.1875	.8 .03	.62 kg 1.37 lb								
3878A	36.512 1.4375	30.162 1.1875	3.5 .14	.62 kg 1.36 lb								
3879	40.000 1.5748	30.162 1.1875	.8 .03	.57 kg 1.27 lb								
3880	41.275 1.6250	30.162 1.1875	.8 .03	.55 kg 1.22 lb								
<b>3900 Series</b>												
3975	50.800 2.0000	30.048 1.1830	3.5 .14	1.05 kg 2.31 lb	*3919RB	112.712 4.4375	24.605 .9687	3.3 .13	.42 kg .94 lb	30.163 1.1875		3955: EXTENDED LARGE RIB
3977	60.000 2.3622	30.048 1.1830	3.5 .14	.86 kg 1.90 lb	3920	112.712 4.4375	23.812 .9375	3.3 .13	.44 kg .98 lb	30.163 1.1875	3958: EXTENDED LARGE RIB	
3977X	59.987 2.3617	28.000 1.1024	2.3 .09	.84 kg 1.85 lb	*3920-B	112.712 4.4375	23.812 .9375	3.3 .13	.48 kg 1.06 lb	11.112 .4375	3959: BROKEN BACKFACE ID EXTENDED LARGE RIB	
3978	59.530 2.3437	30.048 1.1830	1.5 .06	.88 kg 1.94 lb	*3920XX	112.712 4.4375	23.812 .9375	3.3 .13	.44 kg .98 lb	30.163 1.1875	3960: EXTENDED LARGE RIB	
3979	57.150 2.2500	30.048 1.1830	3.5 .14	.92 kg 2.03 lb	3921XA	109.985 4.3301	23.812 .9375	.5 .02	.36 kg .80 lb	29.751 1.1713	3984XX: MADE FROM VACUUM MELT STEEL	
3980	60.325 2.3750	30.048 1.1830	3.5 .14	.85 kg 1.88 lb	*3924-BW	115.895 4.5628	30.162 1.1875	1.5 .06	.71 kg 1.56 lb	4.762 .1875	3919RB: GROOVE IN OD FRONTFACE	
3980W	60.325 2.3750	30.048 1.1830	3.5 .14	.84 kg 1.85 lb	3925	112.712 4.4375	23.812 .9375	.8 .03	.46 kg 1.01 lb	30.163 1.1875	3920-B: FLANGE ON OD FRONTFACE, BEARING WIDTH IS T1 DIMENSION	
3981	58.738 2.3125	30.048 1.1830	3.5 .14	.89 kg 1.96 lb	3926	112.712 4.4375	26.988 1.0625	3.3 .13	.53 kg 1.17 lb	33.338 1.3125	3920XX: MADE FROM VACUUM MELT STEEL	
3982	63.500 2.5000	30.048 1.1830	3.5 .14	.78 kg 1.72 lb	3927AS	110.000 4.3307	23.020 .9063	.5 .02	.35 kg .77 lb	29.370 1.1563	3924-BW: FLANGE ON OD FRONTFACE, BEARING WIDTH IS T1 DIMENSION	
3982W	63.500 2.5000	30.048 1.1830	3.5 .14	.76 kg 1.68 lb	3927X	110.000 4.3307	23.812 .9375	3.3 .13	.35 kg .78 lb	30.163 1.1875	KEYWAY IN OD SURFACE	
3982X	63.500 2.5000	30.048 1.1830	7.0 .28	.75 kg 1.65 lb								
3984	66.675 2.6250	30.048 1.1830	3.5 .14	.70 kg 1.55 lb								
*3984XX	66.675 2.6250	30.048 1.1830	3.5 .14	.71 kg 1.56 lb								
3994	66.675 2.6250	30.048 1.1830	5.5 .22	.70 kg 1.55 lb								
*3955	63.500 2.5000	36.398 1.4330	3.5 .14	.92 kg 2.04 lb	3955 and grouped cones may be paired with all single cups corresponding to 3975 and will require 6.350 mm (.2500 in) to be added to the T-width values.							
*3958	57.150 2.2500	36.398 1.4330	3.5 .14	1.10 kg 2.42 lb								
*3959	52.388 2.0625	36.398 1.4330	.3 .01	1.22 kg 2.69 lb								
*3960	60.325 2.3750	36.398 1.4330	5.0 .20	1.00 kg 2.21 lb								

\*\*These Maximum Fillet Radii will be cleared by the Cone or Cup Radii.  
†Bore or O.D. shown are maximum dimensions. \*See Remarks Column.

3900 – 4300 SERIES

3

CONE			Max Shaft Fillet Radii R <sup>**</sup>	Weight	CUP			Max H's'ng Fillet Radii r <sup>**</sup>	Weight	BEARING WIDTH T	Remarks
Number	BORE d	WIDTH B			Number	OUTSIDE DIA D	WIDTH C				
<b>3900 Series (cont)</b>											
3992	66.675 2.6250	29.223 1.1505	5.5 .22	.69 kg 1.52 lb	3992 may be paired with all single cups corresponding to 3975 and will require -.825 mm (-.0325 in) to be added to the T-width values.						
<b>JRM3900 Series</b>											
JRM3935A	35.000 1.3780	18.500 .7284	2.5 .10	-	JRM3968XD	SEE UNIPAC BEARING SECTION					
JRM3938A	38.125 1.5010	18.500 .7284	2.0 .08	-							
JRM3939	39.000 1.5354	18.500 .7284	3.8 .15	-							
JRM3939C	39.000 1.5354	18.500 .7284	3.8 .15	-							
JRM3939W	39.000 1.5354	18.500 .7284	3.8 .15	-							
JRM3939WA	39.000 1.5354	18.500 .7284	3.8 .15	-							
<b>A4000 Series</b>											
A4044	11.112 .4375	10.988 .4326	1.3 .05	.04 kg .08 lb	A4138	34.989 1.3775	8.730 .3437	1.3 .05	.02 kg .05 lb	10.998 .4330	A4051: EXTENDED LARGE RIB EXTENDED SMALL RIB SLOTS IN FRONTFACE NON-ADJUSTABLE CONE
A4049	12.680 .4992	10.988 .4326	.8 .03	.03 kg .07 lb	*A4138-B	34.989 1.3775	8.730 .3437	1.3 .05	.02 kg .05 lb	4.630 .1823	A4138-B: FLANGE ON OD FRONTFACE, BEARING WIDTH IS T1 DIMENSION
A4050	12.700 .5000	10.988 .4326	1.3 .05	.03 kg .07 lb	*A4138D	34.989 1.3775	20.638 .8125	.6 .02	.06 kg .13 lb	25.174 .9911	A4138D: GROOVE IN OD CENTER HOLES IN OD CENTER
A4059	14.989 .5901	10.988 .4326	.8 .03	.03 kg .06 lb	T54148	34.989 1.3775	8.730 .3437	.3 .01	.02 kg .05 lb	10.998 .4330	K444656: SPECIAL CHAMFER ON LEFTFACE OD SPECIAL CHAMFER ON RIGHTFACE OD
					T54148A	34.989 1.3775	8.730 .3437	.3 .01	.02 kg .05 lb	10.998 .4330	
*A4051	12.700 .5000	14.288 .5625	.8 .03	.04 kg .09 lb	K24299	44.450 1.7500	26.988 1.0625	.8 .03	.17 kg .37 lb	28.578 1.1251	
					K56570	44.450 1.7500	26.988 1.0625	2.3 .09	.17 kg .37 lb	28.578 1.1251	
					K56570A	44.450 1.7500	26.988 1.0625	2.3 .09	.17 kg .37 lb	28.578 1.1251	
					K56570X	44.450 1.7500	26.988 1.0625	2.3 .09	.17 kg .37 lb	28.578 1.1251	
					K97618	41.275 1.6250	26.988 1.0625	.8 .03	.17 kg .37 lb	28.578 1.1251	
					*K444656	44.450 1.7500	26.988 1.0625	2.3 .09	.17 kg .37 lb	28.578 1.1251	
<b>JF4000 Series</b>											
†JF4049	40.000 1.5748	32.500 1.2795	2.5 .10	.58 kg 1.27 lb	†JF4010	85.000 3.3465	28.000 1.1024	2.0 .08	.32 kg .72 lb	33.040 1.3008	
<b>JRM4000 Series</b>											
JRM4040A	39.954 1.5730	16.500 .6496	3.5 .14	-	JRM4076XD	SEE UNIPAC BEARING SECTION					
JRM4042	42.000 1.6535	20.000 .7874	3.5 .14	-	JRM4076XDA	SEE UNIPAC BEARING SECTION					
<b>JRM4200 Series</b>											
JRM4249	42.000 1.6535	19.500 .7677	3.8 .15	-	JRM4210XD	SEE UNIPAC BEARING SECTION					
JRM4248	42.000 1.6535	19.075 .7510	2.5 .10	-	JRM4214XD	SEE UNIPAC BEARING SECTION					
<b>4300 Series</b>											
4367	39.688 1.5625	40.386 1.5900	3.5 .14	.83 kg 1.84 lb	4320	88.500 3.4843	33.338 1.3125	3.3 .13	.38 kg .83 lb	39.687 1.5625	4356: EXTENDED LARGE RIB 4357: EXTENDED LARGE RIB
4368	34.925 1.3750	40.386 1.5900	3.5 .14	.92 kg 2.03 lb	4328	90.043 3.5450	33.338 1.3125	.8 .03	.44 kg .98 lb	39.687 1.5625	4364: EXTENDED LARGE RIB
4370	44.450 1.7500	40.386 1.5900	3.5 .14	.73 kg 1.62 lb	4335	90.488 3.5625	33.338 1.3125	3.3 .13	.45 kg .99 lb	39.687 1.5625	
4375	38.100 1.5000	40.386 1.5900	1.5 .06	.87 kg 1.91 lb							
4375H	38.100 1.5000	40.386 1.5900	1.5 .06	.87 kg 1.91 lb							

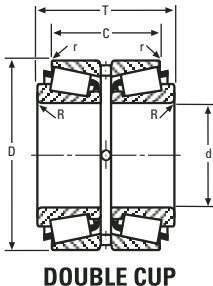
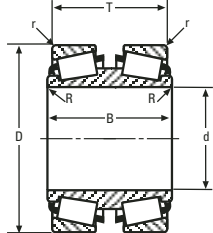
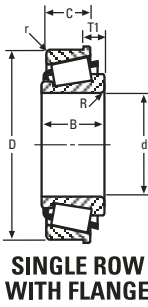
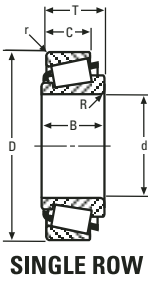

4300 SERIES CONTINUED ON NEXT PAGE

\*\*These Maximum Fillet Radii will be cleared by the Cone or Cup Radii.  
†Bore or O.D. shown are maximum dimensions. \*See Remarks Column.



3

CONE			Max Shaft Fillet Radii R''	Weight	CUP			Max Hs'ng Fillet Radii r''	Weight	BEAR-ING	Remarks
Number	BORE d	WIDTH B			Number	OUTSIDE DIA D	WIDTH C			WIDTH T	
<b>4300 Series (cont)</b>											
4388	41.275 1.6250	40.386 1.5900	3.5 .14	.80 kg 1.77 lb							
4395	42.070 1.6563	40.386 1.5900	3.5 .14	.78 kg 1.73 lb							
4395P	42.070 1.6563	40.386 1.5900	3.5 .14	.78 kg 1.73 lb							
*4356	36.512 1.4375	51.498 2.0275	.5 .02	1.11 kg 2.45 lb	4356 and grouped cones may be paired with all single cups corresponding to 4367 and will require 11.112 mm (.4375 in) to be added to the T-width values.						
*4357	41.275 1.6250	51.498 2.0275	.5 .02	.99 kg 2.19 lb							
*4364	44.450 1.7500	46.736 1.8400	3.5 .14	.83 kg 1.83 lb	4364 may be paired with all single cups corresponding to 4367 and will require 6.350 mm (.2500 in) to be added to the T-width values.						
<b>4500 Series</b>											
4559	45.000 1.7717	40.157 1.5810	3.5 .14	1.19 kg 2.63 lb	4520	101.200 3.9843	33.338 1.3125	3.3 .13	.42 kg .93 lb	39.687 1.5625	4550T: TAPERED BORE
4580	50.800 2.0000	40.157 1.5810	3.5 .14	1.05 kg 2.32 lb	4535	104.775 4.1250	33.338 1.3125	3.3 .13	.57 kg 1.26 lb	39.687 1.5625	
4595	53.975 2.1250	40.157 1.5810	3.5 .14	.97 kg 2.14 lb	4536	111.125 4.3750	32.545 1.2813	3.3 .13	.83 kg 1.82 lb	38.895 1.5313	
*4550T	53.975 2.1250	46.507 1.8310	6.4 .25	1.12 kg 2.47 lb	4550T and grouped cones may be paired with all single cups corresponding to 4559 and will require 6.350 mm (.2500 in) to be added to the T-width values.						
4553	53.975 2.1250	46.507 1.8310	3.5 .14	1.10 kg 2.42 lb							
<b>JF4500 Series</b>											
*†JF4549	45.000 1.7717	35.000 1.3780	2.5 .10	.77 kg 1.70 lb	†JF4510	95.000 3.7402	30.000 1.1811	2.5 .10	.42 kg .92 lb	36.000 1.4173	JF4549: FRONTFACE CHAMFER
<b>JW4500 Series</b>											
†JW4549	45.000 1.7717	26.500 1.0433	2.5 .10	.57 kg 1.25 lb	†JW4510	95.000 3.7402	20.000 .7874	2.5 .10	.34 kg .76 lb	29.000 1.1417	
<b>A5000 Series</b>											
A5069	17.455 .6872	11.112 .4375	1.5 .06	.03 kg .07 lb	*A5144V	36.525 1.4380	7.938 .3125	1.5 .06	.02 kg .04 lb	11.112 .4375	A5069V: MADE FROM SPECIAL STEEL A5144V : MADE FROM SPECIAL STEEL
*A5069V	17.455 .6872	11.112 .4375	1.5 .06	.03 kg .07 lb	A5144	36.525 1.4380	7.938 .3125	1.5 .06	.02 kg .04 lb	11.112 .4375	
<b>JP5000 Series</b>											
*†JP5049P	SEE HYDRA-RIB SECTION				*†JP5017HR	SEE HYDRA-RIB SECTION					
*†JP5049PH	SEE HYDRA-RIB SECTION				*†JP5019HR	SEE HYDRA-RIB SECTION					
	SEE HYDRA-RIB SECTION				*†JP5020HR	SEE HYDRA-RIB SECTION					
<b>JW5000 Series</b>											
*†JW5049	50.000 1.9685	29.000 1.1417	3.0 .12	.77 kg 1.71 lb	†JW5010	105.000 4.1339	22.000 .8661	3.0 .12	.46 kg 1.02 lb	32.000 1.2598	JW5049: FRONTFACE CHAMFER
<b>5300 Series</b>											
5356	44.450 1.7500	44.475 1.7510	1.3 .05	1.24 kg 2.73 lb	5320	101.200 3.9843	36.512 1.4375	3.3 .13	.54 kg 1.18 lb	43.657 1.7188	5354: BROKEN BACKFACE ID
5358	47.625 1.8750	44.475 1.7510	1.3 .05	1.16 kg 2.56 lb	*5335V	103.188 4.0625	36.512 1.4375	3.3 .13	.63 kg 1.38 lb	43.657 1.7188	5395V: MADE FROM VACUUM MELT STEEL
5361	47.625 1.8750	44.475 1.7510	3.5 .14	1.15 kg 2.54 lb	5335	103.188 4.0625	36.512 1.4375	3.3 .13	.63 kg 1.38 lb	43.657 1.7188	5335V : MADE FROM VACUUM MELT STEEL
5395	49.212 1.9375	44.475 1.7510	3.5 .14	1.11 kg 2.45 lb							
*5395V	49.212 1.9375	44.475 1.7510	3.5 .14	1.11 kg 2.45 lb							
*5354	44.450 1.7500	53.238 2.0960	.3 .01	1.43 kg 3.16 lb	5354 may be paired with all single cups corresponding to 5356 and will require 8.763 mm (.3450 in) to be added to the T-width values.						
5360	50.000 1.9685	43.713 1.7210	3.0 .12	1.08 kg 2.38 lb	5360 may be paired with all single cups corresponding to 5356 and will require -.762 mm (-.0300 in) to be added to the T-width values.						

\*\*These Maximum Fillet Radii will be cleared by the Cone or Cup Radii.  
†Bore or O.D. shown are maximum dimensions. \*See Remarks Column.

5500 – A6000 SERIES

3

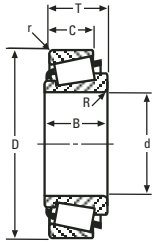

SINGLE ROW



SINGLE ROW WITH FLANGE

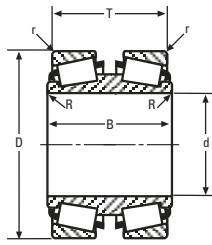

DOUBLE CONE

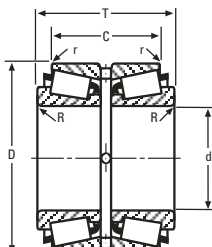

DOUBLE CUP

CONE			Max Shaft Fillet Radii R <sup>**</sup>	Weight	CUP			Max Hs'ng Fillet Radii r <sup>**</sup>	Weight	BEARING WIDTH T	Remarks
Number	BORE d	WIDTH B			Number	OUTSIDE DIA D	WIDTH C				
<b>5500 Series</b>											
5562	49.212 1.9375	43.764 1.7230	1.3 .05	1.93 kg 4.26 lb	5520	120.251 4.7343	36.512 1.4375	3.3 .13	.71 kg 1.57 lb	44.450 1.7500	5550T: EXTENDED LARGE RIB TAPERED BORE
5564	63.500 2.5000	43.764 1.7230	5.0 .20	1.48 kg 3.26 lb	5521	130.000 5.1181	36.512 1.4375	3.3 .13	1.26 kg 2.78 lb	44.450 1.7500	5552: EXTENDED LARGE RIB
5565	50.800 2.0000	43.764 1.7230	1.3 .05	1.89 kg 4.17 lb	5535	122.238 4.8125	36.512 1.4375	3.3 .13	.80 kg 1.77 lb	43.657 1.7188	5553: BROKEN BACKFACE ID EXTENDED LARGE RIB
5566	55.562 2.1875	43.764 1.7230	1.3 .05	1.75 kg 3.87 lb	*5535-B	122.238 4.8125	36.512 1.4375	3.3 .13	.89 kg 1.96 lb	13.495 .5313	5557: EXTENDED LARGE RIB
5577	53.975 2.1250	43.764 1.7230	1.3 .05	1.80 kg 3.97 lb	*5535V	122.238 4.8125	36.512 1.4375	3.3 .13	.80 kg 1.77 lb	43.657 1.7188	5578V: MADE FROM VACUUM MELT STEEL
5578	53.975 2.1250	43.764 1.7230	3.5 .14	1.79 kg 3.95 lb							5583V: MADE FROM VACUUM MELT STEEL
*5578V	53.975 2.1250	43.764 1.7230	3.5 .14	1.79 kg 3.95 lb							5584V: MADE FROM VACUUM MELT STEEL
5582	60.325 2.3750	43.764 1.7230	.8 .03	1.61 kg 3.54 lb							5535-B : FLANGE ON OD FRONTFACE, BEARING WIDTH IS T1 DIMENSION
5583	60.325 2.3750	43.764 1.7230	3.5 .14	1.60 kg 3.52 lb							5535V : MADE FROM VACUUM MELT STEEL
*5583V	60.325 2.3750	43.764 1.7230	3.5 .14	1.60 kg 3.52 lb							
5584	63.500 2.5000	43.764 1.7230	3.5 .14	1.49 kg 3.29 lb							
*5584V	63.500 2.5000	43.764 1.7230	3.5 .14	1.49 kg 3.29 lb							
5595	65.883 2.5938	43.764 1.7230	3.5 .14	1.41 kg 3.10 lb							
*5550T	66.675 2.6250	51.702 2.0355	6.8 .27	1.67 kg 3.68 lb	5550T and grouped cones may be paired with all single cups corresponding to 5562 and will require 7.938 mm (.3125 in) to be added to the T-width values.						
*5552	63.500 2.5000	51.702 2.0355	3.5 .14	1.72 kg 3.80 lb							
*5553	66.675 2.6250	51.702 2.0355	.3 .01	1.60 kg 3.53 lb							
*5557	68.262 2.6875	51.702 2.0355	3.5 .14	1.52 kg 3.36 lb							
5569	60.000 2.3622	44.313 1.7446	3.0 .12	1.63 kg 3.59 lb	5569 may be paired with all single cups corresponding to 5562 and will require .549 mm (.0216 in) to be added to the T-width values.						
<b>JS-5500 Series</b>											
†JS-5547	52.400 2.0630	29.500 1.1614	4.0 .16	.70 kg 1.54 lb	†JS-5510	100.000 3.9370	24.000 .9449	2.5 .10	.36 kg .80 lb	30.000 1.1811	
<b>JW5500 Series</b>											
*†JW5549	55.000 2.1654	31.000 1.2205	3.0 .12	1.00 kg 2.20 lb	†JW5510	115.000 4.5276	23.500 .9252	3.0 .12	.57 kg 1.26 lb	34.000 1.3386	JW5549: FRONTFACE CHAMFER
<b>5700 Series</b>											
5760	76.200 3.0000	46.100 1.8150	3.5 .14	1.83 kg 4.03 lb	5720	142.138 5.5960	34.925 1.3750	3.3 .13	1.25 kg 2.76 lb	44.450 1.7500	5757T: TAPERED BORE
*5784T	80.962 3.1875	46.100 1.8150	3.4 .13	1.68 kg 3.71 lb	5722	140.081 5.5150	47.625 1.8750	3.3 .13	1.59 kg 3.50 lb	57.150 2.2500	5784T: TAPERED BORE 5735V : MADE FROM VACUUM MELT STEEL
5795	77.788 3.0625	46.100 1.8150	3.5 .14	1.76 kg 3.88 lb	*5735V	135.733 5.3438	34.925 1.3750	3.3 .13	.89 kg 1.97 lb	44.450 1.7500	
					5735	135.733 5.3438	34.925 1.3750	3.3 .13	.87 kg 1.92 lb	44.450 1.7500	
5752	73.025 2.8750	52.451 2.0650	5.0 .20	2.19 kg 4.84 lb	5752 and grouped cones may be paired with all single cups corresponding to 5760 and will require 6.350 mm (.2500 in) to be added to the T-width values.						
5755	76.200 3.0000	52.451 2.0650	3.5 .14	2.05 kg 4.53 lb							
*5757T	80.962 3.1875	52.451 2.0650	3.4 .13	1.87 kg 4.13 lb							
<b>A6000 Series</b>											
A6062	15.875 .6250	11.153 .4391	1.3 .05	.04 kg 1.0 lb	A6157	39.992 1.5745	9.525 .3750	1.3 .05	.03 kg .07 lb	12.014 .4730	A6157-B: FLANGE ON OD FRONTFACE, BEARING WIDTH IS T1 DIMENSION
A6067	16.993 .6690	11.153 .4391	.8 .03	.04 kg .09 lb	A6157A	39.982 1.5741	9.525 .3750	1.3 .05	.03 kg .07 lb	12.014 .4730	

A6000 SERIES CONTINUED ON NEXT PAGE

\*\*These Maximum Fillet Radii will be cleared by the Cone or Cup Radii.  
†Bore or O.D. shown are maximum dimensions. \*See Remarks Column.

3

CONE			Max Shaft Fillet Radii R''	Weight	CUP			Max Hs'ng Fillet Radii r''	Weight	BEARING	Remarks
Number	BORE d	WIDTH B			Number	OUTSIDE DIA D	WIDTH C			WIDTH T	
<b>A6000 Series (cont)</b>											
A6075	19.050 .7500	11.153 .4391	1.0 .04	.04 kg .08 lb	*A6157-B 39.992 1.5745	9.525 .3750	1.3 .05	.04 kg .08 lb	4.851 .1910		
					A6162 41.275 1.6250	8.730 .3437	1.3 .05	.03 kg .08 lb	11.905 .4687		
<b>JF6000 Series</b>											
*†JF6049	60.000 2.3622	39.000 1.5354	2.5 .10	1.24 kg 2.74 lb	†JF6010 115.000 4.5276	33.000 1.2992	2.5 .10	.62 kg 1.37 lb	40.000 1.5748	JF6049: FRONTFACE CHAMFER	
<b>JN6000 Series</b>											
†JN6049	60.000 2.3622	46.000 1.8110	5.0 .20	1.76 kg 3.87 lb	†JN6010 125.000 4.9213	40.000 1.5748	2.5 .10	1.07 kg 2.36 lb	48.000 1.8898		
<b>JP6000 Series</b>											
†JP6049	60.000 2.3622	20.000 .7874	2.0 .08	.43 kg .94 lb	†JP6010 100.000 3.9370	15.500 .6102	2.0 .08	.17 kg .38 lb	21.000 .8268	JP6010-B : FLANGE ON OD FRONTFACE, BEARING WIDTH IS T1 DIMENSION	
					*†JP6010-B 100.000 3.9370	15.500 .6102	2.0 .08	.20 kg .43 lb	8.500 .3347		
<b>JW6000 Series</b>											
*†JW6049	60.000 2.3622	33.500 1.3189	3.0 .12	1.27 kg 2.81 lb	†JW6010 125.000 4.9213	26.000 1.0236	3.0 .12	.75 kg 1.65 lb	37.000 1.4567	JW6049: FRONTFACE CHAMFER	
<b>6200 Series</b>											
6277	44.450 1.7500	52.388 2.0625	3.5 .14	2.34 kg 5.16 lb	6220 127.000 5.0000	41.275 1.6250	3.3 .13	1.21 kg 2.67 lb	50.800 2.0000	6220-B : FLANGE ON OD FRONTFACE, BEARING WIDTH IS T1 DIMENSION	
6279	50.800 2.0000	52.388 2.0625	3.5 .14	2.15 kg 4.73 lb	*6220-B 127.000 5.0000	41.275 1.6250	3.3 .13	1.32 kg 2.91 lb	17.462 .6875		
6280	53.975 2.1250	52.388 2.0625	3.5 .14	2.04 kg 4.49 lb							
<b>6300 Series</b>											
6361	60.000 2.3622	56.007 2.2050	3.0 .12	2.47 kg 5.44 lb	6320 135.755 5.3447	44.450 1.7500	3.3 .13	1.37 kg 3.03 lb	53.975 2.1250	6386V: MADE FROM VACUUM MELT STEEL	
6375	57.150 2.2500	56.007 2.2050	4.3 .17	2.57 kg 5.68 lb	*6320-B 135.755 5.3447	44.450 1.7500	3.3 .13	1.49 kg 3.29 lb	17.462 .6875	6320-B: FLANGE ON OD FRONTFACE, BEARING WIDTH IS T1 DIMENSION	
6376	60.325 2.3750	56.007 2.2050	3.5 .14	2.45 kg 5.40 lb	*6320V 135.755 5.3447	44.450 1.7500	3.3 .13	1.37 kg 3.03 lb	53.975 2.1250	6320V : MADE FROM VACUUM MELT STEEL	
6379	65.088 2.5625	56.007 2.2050	3.5 .14	2.24 kg 4.95 lb	6321 131.762 5.1875	44.450 1.7500	3.3 .13	1.08 kg 2.39 lb	53.975 2.1250		
6380	54.813 2.1580	56.007 2.2050	.8 .03	2.68 kg 5.90 lb	6325 135.000 5.3150	44.450 1.7500	3.0 .12	1.32 kg 2.91 lb	53.975 2.1250		
6381	54.988 2.1649	56.007 2.2050	3.5 .14	2.66 kg 5.87 lb	†J6327 140.000 5.5118	44.450 1.7500	3.3 .13	1.69 kg 3.73 lb	53.975 2.1250		
6382	63.500 2.5000	56.007 2.2050	4.3 .17	2.31 kg 5.09 lb							
6385	64.973 2.5580	56.007 2.2050	3.5 .14	2.25 kg 4.96 lb							
6385-S	65.000 2.5591	56.007 2.2050	3.0 .12	2.25 kg 4.96 lb							
6386	66.675 2.6250	56.007 2.2050	4.3 .17	2.17 kg 4.78 lb							
6386A	66.675 2.6250	56.007 2.2050	8.7 .34	2.11 kg 4.66 lb							
*6386V	66.675 2.6250	56.007 2.2050	4.3 .17	2.17 kg 4.78 lb							
6387	57.150 2.2500	56.007 2.2050	.8 .03	2.59 kg 5.71 lb							
6389	66.675 2.6250	56.007 2.2050	6.4 .25	2.15 kg 4.74 lb							
6391	59.987 2.3617	56.007 2.2050	3.5 .14	2.46 kg 5.43 lb							
†J6392	65.000 2.5591	56.007 2.2050	3.0 .12	2.25 kg 4.96 lb							
6377	65.088 2.5625	65.532 2.5800	6.5 .26	2.51 kg 5.55 lb	6377 and grouped cones may be paired with all single cups corresponding to 6361 and will require 9.525 mm (.3750 in) to be added to the T-width values.						
6377A	65.088 2.5625	65.532 2.5800	6.5 .26	2.53 kg 5.57 lb							

\*\*These Maximum Fillet Radii will be cleared by the Cone or Cup Radii.  
†Bore or O.D. shown are maximum dimensions. \*See Remarks Column.

6400 – JD6500 SERIES

3

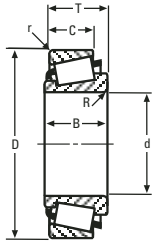

SINGLE ROW

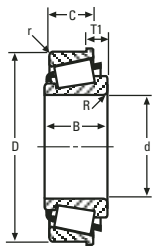

SINGLE ROW WITH FLANGE

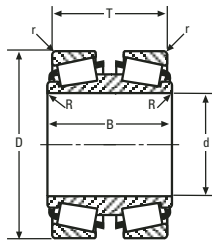

DOUBLE CONE

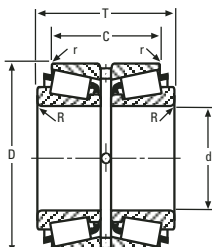

DOUBLE CUP

CONE			Max Shaft Fillet Radii R''	Weight	CUP			Max Hs'ng Fillet Radii r''	Weight	BEARING	Remarks
Number	BORE d	WIDTH B			Number	OUTSIDE DIA D	WIDTH C			WIDTH T	
<b>6400 Series</b>											
6454	69.850 2.7500	54.229 2.1350	5.0 .20	-	6420	149.225 5.8750	44.450 1.7500	3.3 .13	1.62 kg 3.56 lb	53.975 2.1250	6420-B: FLANGE ON OD FRONTFACE, BEARING WIDTH IS T1 DIMENSION
6455	57.150 2.2500	54.229 2.1350	3.5 .14	-	6420A	149.225 5.8750	44.450 1.7500	.8 .03	1.63 kg 3.60 lb	53.975 2.1250	
6459	70.000 2.7559	54.229 2.1350	3.0 .12	-	*6420-B	149.225 5.8750	44.450 1.7500	3.3 .13	1.74 kg 3.83 lb	17.462 .6875	
6460	73.025 2.8750	54.229 2.1350	3.5 .14	-	6424	150.000 5.9055	45.000 1.7717	3.0 .12	1.70 kg 3.74 lb	54.000 2.1260	
6461	76.200 3.0000	54.229 2.1350	3.5 .14	-	6427	157.162 6.1875	44.450 1.7500	3.3 .13	-	53.975 2.1250	
6461A	76.200 3.0000	54.229 2.1350	9.7 .38	-							
6461CA	76.200 3.0000	54.229 2.1350	3.5 .14	-							
6464	64.960 2.5575	54.229 2.1350	3.5 .14	-							
6465	57.150 2.2500	54.229 2.1350	6.8 .27	-							
6466	76.200 3.0000	54.229 2.1350	6.4 .25	-							
6475	63.500 2.5000	54.229 2.1350	3.5 .14	-							
6484	69.850 2.7500	54.229 2.1350	6.4 .25	-							
<b>6500 Series</b>											
6559C	82.550 3.2500	55.100 2.1693	3.5 .14	3.39 kg 7.47 lb	6520	169.850 6.6870	44.450 1.7500	3.3 .13	2.38 kg 5.24 lb	53.975 2.1250	6550T: TAPERED BORE
6559CP	82.550 3.2500	55.100 2.1693	3.5 .14	3.45 kg 7.60 lb	6521	160.338 6.3125	44.450 1.7500	3.3 .13	1.54 kg 3.40 lb	53.975 2.1250	6552W: KEYWAY IN ID
*6559V	82.550 3.2500	55.100 2.1693	3.5 .14	3.42 kg 7.53 lb	6525X	160.000 6.2992	44.450 1.7500	3.0 .12	1.52 kg 3.34 lb	53.975 2.1250	6559V: MADE FROM VACUUM MELT STEEL
6574P	76.162 2.9985	55.100 2.1693	3.5 .14	3.78 kg 8.34 lb	6535	161.925 6.3750	42.862 1.6875	3.3 .13	1.65 kg 3.64 lb	53.974 2.1250	6576V: MADE FROM VACUUM MELT STEEL
6575	76.200 3.0000	55.100 2.1693	6.4 .25	3.70 kg 8.16 lb	*6535-B	161.925 6.3750	42.862 1.6875	3.3 .13	1.74 kg 3.84 lb	19.050 .7500	6580V: MADE FROM VACUUM MELT STEEL
6576	76.200 3.0000	55.100 2.1693	3.5 .14	3.73 kg 8.22 lb	6535P	161.925 6.3750	42.862 1.6875	3.3 .13	1.66 kg 3.65 lb	53.974 2.1250	6535-B: FLANGE ON OD FRONTFACE, BEARING WIDTH IS T1 DIMENSION
6576C	76.200 3.0000	55.100 2.1693	3.5 .14	3.73 kg 8.22 lb	*6535W	161.925 6.3750	42.862 1.6875	3.3 .13	1.69 kg 3.72 lb	53.974 2.1250	6535W: KEYWAY BACKFACE
6576CP	76.200 3.0000	55.100 2.1693	3.5 .14	3.79 kg 8.35 lb	6536	161.925 6.3750	42.862 1.6875	.8 .03	1.67 kg 3.69 lb	53.974 2.1250	6536V: MADE FROM VACUUM MELT STEEL
*6576V	76.200 3.0000	55.100 2.1693	3.5 .14	3.73 kg 8.22 lb	*6536V	161.925 6.3750	42.862 1.6875	.8 .03	1.67 kg 3.69 lb	53.974 2.1250	
6580	88.900 3.5000	55.100 2.1693	3.5 .14	3.02 kg 6.65 lb							
*6580V	88.900 3.5000	55.100 2.1693	3.5 .14	3.02 kg 6.65 lb							
6581X	90.000 3.5433	55.100 2.1693	3.0 .12	2.95 kg 6.51 lb							
†J6581X	90.000 3.5433	55.100 2.1693	3.0 .12	2.95 kg 6.51 lb							
*6550T	85.725 3.3750	63.830 2.5130	8.0 .31	4.24 kg 9.35 lb	6550T and grouped cones may be paired with all single cups corresponding to 6559C and will require 8.730 mm (.3437 in) to be added to the T-width values.						
6552	88.900 3.5000	63.830 2.5130	3.5 .14	3.43 kg 7.55 lb							
*6552W	88.900 3.5000	63.830 2.5130	3.5 .14	3.77 kg 8.32 lb							
6553	85.725 3.3750	63.830 2.5130	6.8 .27	3.61 kg 7.95 lb							
6554	76.200 3.0000	63.830 2.5130	3.5 .14	4.25 kg 9.37 lb							
<b>JD6500 Series</b>											
*†JD6549	65.000 2.5591	31.000 1.2205	2.0 .08	.82 kg 1.81 lb	†JD6510	110.000 4.3307	25.000 .9843	2.0 .08	.36 kg .80 lb	31.000 1.2205	JD6549: SPECIAL BACKFACE RADIUS

JW6500 SERIES CONTINUED ON NEXT PAGE

\*\*These Maximum Fillet Radii will be cleared by the Cone or Cup Radii.  
†Bore or O.D. shown are maximum dimensions. \*See Remarks Column.

3

CONE			Max Shaft Fillet Radii R''	Weight	CUP			Max Hs'ng Fillet Radii r''	Weight	BEARING	Remarks
Number	BORE d	WIDTH B			Number	OUTSIDE DIA D	WIDTH C			WIDTH T	
<b>JW6500 Series</b>											
*†JW6549	65.000 2.5591	33.500 1.3189	3.0 .12	- -	†JW6510	130.000 5.1181	26.000 1.0236	3.0 .12	.81 kg 1.79 lb	37.000 1.4567	JW6549: FRONTFACE CHAMFER
<b>JF7000 Series</b>											
†JF7049	70.000 2.7559	42.000 1.6535	3.0 .12	1.70 kg 3.75 lb	†JF7010	130.000 5.1181	35.000 1.3780	2.5 .10	.80 kg 1.75 lb	43.000 1.6929	
†JF7049A	70.000 2.7559	42.000 1.6535	7.0 .28	1.66 kg 3.66 lb							
<b>JP7000 Series</b>											
†JP7049	70.000 2.7559	20.000 .7874	2.0 .08	.49 kg 1.09 lb	*†JP7010-B	110.000 4.3307	15.500 .6102	2.0 .08	.22 kg .48 lb	8.500 .3347	JP7010-B : FLANGE ON OD FRONTFACE, BEARING WIDTH IS T1 DIMENSION
					†JP7010	110.000 4.3307	15.500 .6102	2.0 .08	.19 kg .43 lb	21.000 .8268	
<b>JW7000 Series</b>											
†JW7049	70.000 2.7559	35.500 1.3976	3.0 .12	1.69 kg 3.72 lb	†JW7010	140.000 5.5118	27.000 1.0630	3.0 .12	.95 kg 2.10 lb	39.000 1.5354	
<b>JP7500 Series</b>											
*†JP7548P	SEE HYDRA-RIB SECTION				*†JP7519HR	SEE HYDRA-RIB SECTION					
*†JP7549P	SEE HYDRA-RIB SECTION				*†JP7520HR	SEE HYDRA-RIB SECTION					
<b>JW7500 Series</b>											
*†JW7549	75.000 2.9528	38.000 1.4961	3.0 .12	2.05 kg 4.52 lb	†JW7510	150.000 5.9055	29.000 1.1417	3.0 .12	1.17 kg 2.58 lb	42.000 1.6535	JW7549: FRONTFACE CHAMFER
<b>JP8000 Series</b>											
†JP8049	80.000 3.1496	22.500 .8858	2.0 .08	.69 kg 1.52 lb	*†JP8010-B	125.000 4.9213	17.500 .6890	2.0 .08	.33 kg .72 lb	10.500 .4134	JP8049H: HOLES IN BACKFACE TO UNDERCUT
*†JP8049H	80.000 3.1496	22.500 .8858	2.0 .08	- -	†JP8010	125.000 4.9213	17.500 .6890	2.0 .08	.27 kg .60 lb	24.000 .9449	JP8010-B : FLANGE ON OD FRONTFACE, BEARING WIDTH IS T1 DIMENSION
<b>JW8000 Series</b>											
†JW8049	80.000 3.1496	41.000 1.6142	3.0 .12	2.59 kg 5.72 lb	†JW8010	160.000 6.2992	31.000 1.2205	3.0 .12	1.44 kg 3.18 lb	45.000 1.7717	
<b>8307 Series</b>											
8307	34.988 1.3775	34.925 1.3750	1.5 .06	.57 kg 1.26 lb	83073	77.003 3.0316	11.112 .4375	1.5 .06	.09 kg .19 lb	34.925 1.3750	
<b>8500 Series</b>											
8573	228.600 9.0000	52.388 2.0625	6.4 .25	9.23 kg 20.35 lb	*8520-B	327.025 12.8750	36.512 1.4375	3.3 .13	4.31 kg 9.51 lb	25.400 1.0000	8575X: KEYWAY IN ID
8574	234.950 9.2500	52.388 2.0625	6.4 .25	8.46 kg 18.66 lb	8520	327.025 12.8750	36.512 1.4375	3.3 .13	3.81 kg 8.40 lb	52.388 2.0625	NA8575-SW: EXTENDED LARGE RIB FRONTFACE CHAMFER SLOTS IN FRONTFACE
8575	234.950 9.2500	52.388 2.0625	6.4 .25	8.28 kg 18.26 lb	*8520CD	327.025 12.8750	82.550 3.2500	1.5 .06	8.90 kg 19.63 lb	114.300 4.5000	8520-B : FLANGE ON OD FRONTFACE, BEARING WIDTH IS T1 DIMENSION
*8575X	234.950 9.2500	52.388 2.0625	6.4 .25	9.00 kg 19.84 lb	8522	328.625 12.9380	36.512 1.4375	3.3 .13	4.04 kg 8.90 lb	52.388 2.0625	8520CD : GROOVE IN OD CENTER HOLES IN OD CENTER
8578	241.300 9.5000	52.388 2.0625	6.4 .25	7.30 kg 16.10 lb	*8522D	328.625 12.9380	82.550 3.2500	1.5 .06	9.42 kg 20.78 lb	114.300 4.5000	8522D : GROOVE IN OD CENTER HOLES IN OD CENTER
*NA8575-SW	234.950 9.2500	58.738 2.3125	6.4 .25	- -	*8520CD	327.025 12.8750	82.550 3.2500	1.5 .06	8.90 kg 19.63 lb	117.475 4.6250	
					*8522D	328.625 12.9380	82.550 3.2500	1.5 .06	9.42 kg 20.78 lb	117.475 4.6250	
8576D	234.950 9.2500	93.662 3.6875	1.5 .06	20.73 kg 45.70 lb	8520	327.025 12.8750	36.512 1.4375	3.3 .13	3.81 kg 8.40 lb	93.662 3.6875	
8576DW	234.950 9.2500	93.662 3.6875	1.5 .06	20.68 kg 45.60 lb	8522	328.625 12.9380	36.512 1.4375	3.3 .13	4.04 kg 8.90 lb	93.662 3.6875	
<b>JP8500 Series</b>											
JP8548	SEE HYDRA-RIB SECTION				JP8518HR	SEE HYDRA-RIB SECTION					
JP8549P	SEE HYDRA-RIB SECTION				JP8519HR	SEE HYDRA-RIB SECTION					
<b>8800 Series</b>											
8880D	241.300 9.5000	92.075 3.6250	1.5 .06	20.58 kg 45.37 lb	8820	342.900 13.5000	34.925 1.3750	3.3 .13	4.40 kg 9.70 lb	92.075 3.6250	

\*These Maximum Fillet Radii will be cleared by the Cone or Cup Radii.  
†Bore or O.D. shown are maximum dimensions. \*See Remarks Column.

8900 – 9900 SERIES

3

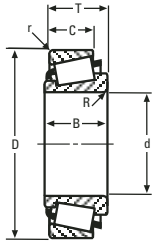

SINGLE ROW

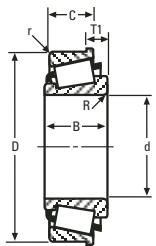

SINGLE ROW WITH FLANGE

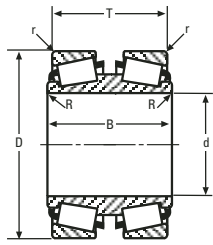

DOUBLE CONE

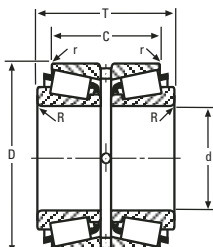

DOUBLE CUP

CONE				Weight	CUP				Weight	BEAR-ING WIDTH T	Remarks
Number	BORE d	WIDTH B	Max Shaft Fillet Radii R		Number	OUTSIDE DIA D	WIDTH C	Max H's'ng Fillet Radii r			
<b>8900 Series</b>											
*8970DW	196.850 7.7500	81.758 3.2188	1.5 .06	17.22 kg 37.98 lb	8920	298.450 11.7500	31.750 1.2500	3.3 .13	2.85 kg 6.27 lb	81.757 3.2188	8970DW: KEYWAY IN ID
8975D	203.200 8.0000	81.758 3.2188	5.6 .22	16.03 kg 35.35 lb							
8976D	203.352 8.0060	81.758 3.2188	5.6 .22	16.00 kg 35.28 lb							
<b>JP9000 Series</b>											
†JP9049	90.000 3.5433	22.500 .8858	2.0 .08	.78 kg 1.73 lb	*†JP9010-B	135.000 5.3150	17.500 .6890	2.0 .08	.36 kg .78 lb	10.500 .4134	JP9010-B: FLANGE ON OD FRONTFACE, BEARING WIDTH IS T1 DIMENSION
					†JP9010	135.000 5.3150	17.500 .6890	2.0 .08	.31 kg .68 lb	24.000 .9449	
<b>9100 Series</b>											
9180	61.912 2.4375	46.038 1.8125	3.5 .14	2.88 kg 6.35 lb	9120	158.750 6.2500	34.925 1.3750	3.3 .13	1.82 kg 4.01 lb	50.800 2.0000	9178 may be paired with all single cups corresponding to 9180 and will require 4.762 mm (.1875 in) to be added to the T-width values.
9181	61.912 2.4375	46.038 1.8125	.8 .03	2.89 kg 6.37 lb	9121	152.400 6.0000	31.750 1.2500	3.3 .13	1.20 kg 2.64 lb	47.625 1.8750	
9185	68.262 2.6875	46.038 1.8125	3.5 .14	2.64 kg 5.83 lb							
9178	61.912 2.4375	52.388 2.0625	3.5 .14	3.14 kg 6.91 lb							
9278	68.262 2.6875	46.038 1.8125	3.5 .14	3.27 kg 7.21 lb	9220	161.925 6.3750	31.750 1.2500	3.3 .13	1.37 kg 3.03 lb	49.212 1.9375	
<b>9200 Series</b>											
9285	76.200 3.0000	46.038 1.8125	3.5 .14	2.94 kg 6.49 lb	*9220D	161.925 6.3750	70.637 2.7810	.8 .03	2.89 kg 6.38 lb	105.562 4.1560	9285XX: MADE FROM VACUUM MELT STEEL 9220D: GROOVE IN OD CENTER HOLES IN OD CENTER
*9285XX	76.200 3.0000	46.038 1.8125	3.5 .14	2.90 kg 6.39 lb	*9220XX	161.925 6.3750	31.750 1.2500	3.3 .13	1.37 kg 3.03 lb	49.212 1.9375	9220XX: MADE FROM VACUUM MELT STEEL
					*9221-B	161.925 6.3750	30.162 1.1875	3.3 .13	1.46 kg 3.23 lb	24.600 .9685	9221-B: FLANGE ON OD FRONTFACE, BEARING WIDTH IS T1 DIMENSION
9275	60.325 2.3750	46.038 1.8125	3.5 .14	3.51 kg 7.73 lb							9275 may be paired with all single cups corresponding to 9278 and will require -1.588 mm (-.0625 in) to be added to the T-width values. 9275 may be paired with all double cups corresponding to 9278 and will require -3.175 mm (-.1250 in) to be added to the T-width values.
<b>9300 Series</b>											
*NA9378	76.200 3.0000	54.767 2.1562	3.5 .14	- -	*9320D	177.800 7.0000	74.612 2.9375	2.3 .09	4.64 kg 10.23 lb	109.535 4.3124	NA9378: EXTENDED SMALL RIB 9320D: GROOVE IN OD CENTER HOLES IN OD CENTER
9380	76.200 3.0000	46.038 1.8125	3.5 .14	3.62 kg 7.98 lb	9320	177.800 7.0000	34.925 1.3750	3.3 .13	2.19 kg 4.83 lb	52.387 2.0625	9321-B: FLANGE ON OD FRONTFACE, BEARING WIDTH IS T1 DIMENSION
9382	69.914 2.7525	46.038 1.8125	3.5 .14	3.88 kg 8.55 lb	*9320D	177.800 7.0000	74.612 2.9375	2.3 .09	4.64 kg 10.23 lb	109.537 4.3125	
9386H	84.138 3.3125	46.038 1.8125	3.5 .14	3.21 kg 7.08 lb	*9321-B	171.450 6.7500	31.750 1.2500	3.3 .13	1.77 kg 3.91 lb	25.400 1.0000	
					9321	171.450 6.7500	31.750 1.2500	3.3 .13	1.49 kg 3.28 lb	49.212 1.9375	
9378	76.200 3.0000	50.800 2.0000	3.5 .14	3.86 kg 8.52 lb							9378 may be paired with all single cups corresponding to 9380 and will require 3.175 mm (.1250 in) to be added to the T-width values. 9378 may be paired with all double cups corresponding to 9380 and will require 6.350 mm (.2500 in) to be added to the T-width values.
<b>JF9500 Series</b>											
†JF9549	95.000 3.7402	46.000 1.8110	3.0 .12	2.58 kg 5.68 lb	†JF9510	160.000 6.2992	38.000 1.4961	3.0 .12	1.18 kg 2.60 lb	46.000 1.8110	
<b>9900 Series</b>											
*9974D	216.103 8.5080	127.000 5.0000	1.5 .06	31.83 kg 70.18 lb	9920	330.200 13.0000	50.800 2.0000	3.3 .13	7.09 kg 15.64 lb	130.175 5.1250	9974D: ASYMMETRICAL BEARING SHOULDER ON OD RIGHTFACE
*9974DW	216.103 8.5080	127.000 5.0000	1.5 .06	31.80 kg 70.12 lb							9974DW: ASYMMETRICAL BEARING SHOULDER ON OD RIGHTFACE SLOTS IN LEFTFACE 9976D: HOLES IN OD CENTER

9900 SERIES CONTINUED ON NEXT PAGE

\*\*These Maximum Fillet Radii will be cleared by the Cone or Cup Radii.  
†Bore or O.D. shown are maximum dimensions. \*See Remarks Column.

CONE			Max Shaft Fillet Radii R <sup>**</sup>	Weight	CUP			Max Hs'ng Fillet Radii r <sup>**</sup>	Weight	BEAR-ING	Remarks
Number	BORE d	WIDTH B			Number	OUTSIDE DIA D	WIDTH C			WIDTH T	
9900 Series (cont)											
*9976D	215.900 8.5000	193.675 7.6250	3.3 .13	45.67 kg 100.71 lb							9976D may be paired with all single cups corresponding to 9974D and will require 73.025 mm (2.8750 in) to be added to the T-width values.
9977D	216.103 8.5080	142.875 5.6250	3.3 .13	36.22 kg 79.86 lb							9977D may be paired with all single cups corresponding to 9974D and will require 22.225 mm (.8750 in) to be added to the T-width values.

\*\*These Maximum Fillet Radii will be cleared by the Cone or Cup Radii.  
†Bore or O.D. shown are maximum dimensions. \*See Remarks Column.

00000 – 03000 SERIES

4

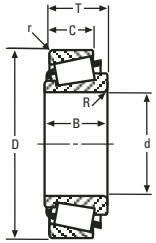

SINGLE ROW

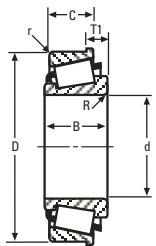

SINGLE ROW WITH FLANGE

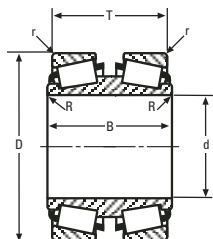

DOUBLE CONE

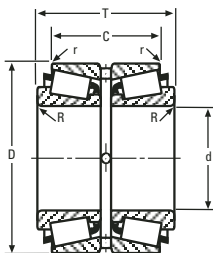

DOUBLE CUP

CONE			Max Shaft Fillet Radii R**	Weight	CUP			Max Hs'ng Fillet Radii r**	Weight	BEARING	Remarks	
Number	BORE d	WIDTH B			Number	OUTSIDE DIA D	WIDTH C			WIDTH T		
<b>00000 Series</b>												
00050	12.700 .5000	14.072 .5540	1.5 .06	.05 kg .10 lb	00150	38.100 1.5000	11.112 .4375	.8 .03	.03 kg .08 lb	13.495 .5313	00153DB: FLANGE ON OD LEFTFACE  0068X: EXTENDED LARGE RIB	
00059	13.500 .5315	14.072 .5540	2.5 .10	.04 kg .10 lb	00152	38.100 1.5000	13.556 .5337	.8 .03	.04 kg .09 lb	13.736 .5408		
					00152X	36.512 1.4375	11.112 .4375	1.5 .06	.03 kg .06 lb	13.495 .5313		
					*00153DB	38.100 1.5000	25.400 1.0000	.8 .03	.09 kg .20 lb	30.957 1.2188		
					00162X	41.300 1.6260	14.288 .5625	.3 .01	.07 kg .14 lb	13.973 .5501		
00053												
00055	SEE MULTI-ROW STEERING GEAR BEARING SECTION											
00057												
00058												
*00068X	11.112 .4375	18.110 .7130	.8 .03	.06 kg .14 lb	00068X may be paired with all single cups corresponding to 00050 and will require 4.140 mm (.1630 in) to be added to the T-width values. 00068X may be paired with all double cups corresponding to 00050 and will require 8.280 mm (.3260 in) to be added to the T-width values.							
<b>02400 Series</b>												
02473	25.400 1.0000	22.225 .8750	.8 .03	.28 kg .61 lb	02419	66.987 2.6373	16.000 .6299	1.5 .06	.11 kg .25 lb	20.500 .8071	02420-B: FLANGE ON OD FRONT FACE, BEARING WIDTH IS T1 DIMENSION	
02473X	27.988 1.1019	20.500 .8071	.8 .03	.25 kg .55 lb	02420	68.262 2.6875	17.462 .6875	1.5 .06	.15 kg .33 lb	22.225 .8750		
02474	28.575 1.1250	22.225 .8750	.8 .03	.25 kg .56 lb	02420A	68.262 2.6875	16.238 .6393	1.5 .06	.14 kg .31 lb	21.000 .8268		
02474A	29.987 1.1806	22.225 .8750	.8 .03	.24 kg .54 lb	*02420-B	68.262 2.6875	17.462 .6875	1.5 .06	.20 kg .45 lb	8.730 .3437		
02474W	28.575 1.1250	22.225 .8750	.8 .03	.25 kg .54 lb	02421	68.262 2.6875	17.462 .6875	.8 .03	.15 kg .33 lb	22.225 .8750		
02475	31.750 1.2500	22.225 .8750	3.5 .14	.22 kg .49 lb								
02475A	31.750 1.2500	22.225 .8750	1.5 .06	.23 kg .50 lb								
02475W	31.750 1.2500	22.225 .8750	.8 .03	.22 kg .47 lb								
02476	31.750 1.2500	22.225 .8750	.8 .03	.23 kg .50 lb								
02476X	31.986 1.2593	20.500 .8071	.8 .03	.22 kg .48 lb								
<b>02800 Series</b>												
02872	28.575 1.1250	22.225 .8750	.8 .03	.33 kg .72 lb	02820	73.025 2.8750	17.462 .6875	3.3 .13	.15 kg .34 lb	22.225 .8750		02823D : GROOVE IN OD CENTER HOLES IN OD CENTER
02875	31.750 1.2500	22.225 .8750	3.5 .14	.29 kg .65 lb	*02823D	76.200 3.0000	38.100 1.5000	.8 .03	.47 kg 1.04 lb	47.625 1.8750		
02876	31.750 1.2500	22.225 .8750	.8 .03	.30 kg .66 lb	02830	73.025 2.8750	17.462 .6875	.8 .03	.16 kg .36 lb	22.225 .8750		
02877	34.925 1.3750	22.225 .8750	3.5 .14	.26 kg .58 lb	02831	80.962 3.1875	17.462 .6875	.8 .03	.29 kg .65 lb	22.225 .8750		
02878	34.925 1.3750	22.225 .8750	.8 .03	.27 kg .59 lb								
02884	36.449 1.4350	22.225 .8750	.8 .03	.25 kg .56 lb								
<b>03000 Series</b>												
03062	15.875 .6250	14.681 .5780	1.3 .05	.06 kg .13 lb	03157X	40.000 1.5748	11.112 .4375	1.5 .06	.03 kg .06 lb	14.287 .5625	NA03063-SW: FRONTFACE CHAMFER SLOTS IN FRONTFACE  K24429 : SPECIAL RADIUS ON LEFTFACE OD SPECIAL RADIUS ON RIGHTFACE OD	
03066X	17.000 .6693	14.681 .5780	.8 .03	.06 kg .13 lb	03162	41.275 1.6250	11.112 .4375	2.0 .08	.03 kg .08 lb	14.287 .5625		

03000 SERIES CONTINUED ON NEXT PAGE

\*\*These Maximum Fillet Radii will be cleared by the Cone or Cup Radii.  
†Bore or O.D. shown are maximum dimensions. \*See Remarks Column.



4

CONE			Max Shaft Fillet Radii R <sup>**</sup>	Weight	CUP			Max Hs'ng Fillet Radii r <sup>**</sup>	Weight	BEAR-ING	Remarks
Number	BORE d	WIDTH B			Number	OUTSIDE DIA D	WIDTH C			WIDTH T	
<b>03000 Series (cont)</b>											
*NA03063-SW	15.875 .6250	18.258 .7188	.8 .03	.14 kg .31 lb	*K24429	50.800 2.0000	34.925 1.3750	2.8 .11	.27 kg .59 lb	36.515 1.4376	
					K35667	53.975 2.1250	34.925 1.3750	3.3 .13	.34 kg .75 lb	36.515 1.4376	
					K90651	50.800 2.0000	34.925 1.3750	2.3 .09	.28 kg .62 lb	36.515 1.4376	
					K97770	52.388 2.0625	34.925 1.3750	3.3 .13	.33 kg .72 lb	36.515 1.4376	
<b>05000 Series</b>											
05062	15.875 .6250	14.381 .5662	1.5 .06	-	05175	44.450 1.7500	11.430 4.500	1.5 .06	.03 kg .07 lb	15.494 .6100	NA05076-SW: EXTENDED LARGE RIB FRONTFACE CHAMFER SLOTS IN FRONTFACE
05066	16.993 .6690	14.381 .5662	1.5 .06	-	*05180D	45.984 1.8104	25.212 .9926	.8 .03	.11 kg .24 lb	31.750 1.2500	05180D : GROOVE IN OD CENTER HOLES IN OD CENTER
05068	17.462 .6875	14.381 .5662	.8 .03	-	05185	47.000 1.8504	11.112 4.375	1.3 .05	.05 kg .10 lb	14.381 .5662	05185-B : FLANGE ON OD FRONTFACE, BEARING WIDTH IS T1 DIMENSION
05070X	18.000 .7087	14.381 .5662	1.5 .06	-	05185A	46.982 1.8497	11.112 4.375	1.5 .06	.05 kg .10 lb	14.381 .5662	
05070XS	17.988 .7082	14.381 .5662	2.0 .08	-	*05185-B	47.000 1.8504	11.112 4.375	1.5 .06	.05 kg .12 lb	6.038 .2377	05185D : GROOVE IN OD CENTER HOLES IN OD CENTER
05075	19.050 .7500	14.381 .5662	1.3 .05	-	*05185D	47.000 1.8504	25.212 .9926	.8 .03	.11 kg .24 lb	31.750 1.2500	K39214 : SPECIAL RADIUS ON LEFTFACE OD
05075X	19.050 .7500	14.381 .5662	1.5 .06	-	05185-S	47.000 1.8504	11.112 4.375	1.5 .06	.05 kg .10 lb	14.381 .5662	SPECIAL RADIUS ON RIGHTFACE OD
05075XS	19.050 .7500	14.381 .5662	1.5 .06	-	05186	46.990 1.8500	12.000 4.724	1.5 .06	.05 kg .11 lb	15.250 .6004	K104605 : SPECIAL RADIUS ON LEFTFACE OD SPECIAL RADIUS ON RIGHTFACE OD
05079	19.987 .7869	14.381 .5662	1.5 .06	-							K312495 : SPECIAL RADIUS ON LEFTFACE OD SPECIAL RADIUS ON RIGHTFACE OD SPHERICAL OD
NA05075	19.050 .7500	15.875 .6250	1.3 .05	-	*05180D	45.984 1.8104	25.212 .9926	.8 .03	.11 kg .24 lb	31.750 1.2500	
					*05185D	47.000 1.8504	25.212 .9926	.8 .03	.11 kg .24 lb	31.750 1.2500	
					*K39214	63.500 2.5000	33.338 1.3125	spcl. spcl.	.49 kg 1.07 lb	31.750 1.2500	
					*K104605	57.150 2.2500	33.338 1.3125	spcl. spcl.	.33 kg .72 lb	31.750 1.2500	
					K108609	63.500 2.5000	33.338 1.3125	- -	.44 kg .98 lb	31.750 1.2500	
					*K312495	63.500 2.5000	33.338 1.3125	spcl. spcl.	.38 kg .84 lb	31.750 1.2500	
*NA05076-SW	19.050 .7500	17.462 .6875	.8 .03	-	NA05076-SW may be paired with all double cups corresponding to NA05075 and will require 3.175 mm (.1250 in) to be added to the T-width values.						
<b>07000 Series</b>											
07079	20.000 .7874	14.260 .5614	1.5 .06	.10 kg .22 lb	07196	50.005 1.9687	9.525 .3750	1.0 .04	.03 kg .08 lb	13.495 .5313	07196-B: FLANGE ON OD FRONTFACE, BEARING WIDTH IS T1 DIMENSION
07079X	19.987 .7869	14.260 .5614	1.5 .06	.10 kg .22 lb	*07196-B	50.005 1.9687	9.525 .3750	1.0 .04	.04 kg .09 lb	6.749 .2657	07196D: GROOVE IN OD CENTER HOLES IN OD CENTER
07087	22.225 .8750	14.260 .5614	1.3 .05	.09 kg .21 lb	*07196D	50.005 1.9687	25.400 1.0000	.6 .02	.10 kg .23 lb	33.341 1.3126	07196DC: HOLES IN OD CENTER
07087X	22.225 .8750	14.260 .5614	1.5 .06	.09 kg .21 lb	*07196DC	50.005 1.9687	25.400 1.0000	.6 .02	.10 kg .23 lb	33.341 1.3126	07204-B: FLANGE ON OD FRONTFACE, BEARING WIDTH IS T1 DIMENSION
07090X	22.987 .9050	14.260 .5614	2.5 .10	.09 kg .20 lb	07204	51.994 2.0470	12.700 .5000	1.3 .05	.06 kg .13 lb	15.011 .5910	07205-B: FLANGE ON OD FRONTFACE, BEARING WIDTH IS T1 DIMENSION
07093	23.812 .9375	14.260 .5614	1.5 .06	.09 kg .19 lb	*07204-B	51.994 2.0470	12.700 .5000	1.5 .06	.07 kg .15 lb	5.080 .2000	

\*\*These Maximum Fillet Radii will be cleared by the Cone or Cup Radii.  
†Bore or O.D. shown are maximum dimensions. \*See Remarks Column.

07000 – 09000 SERIES

4

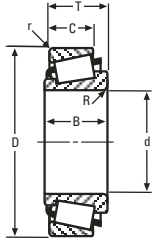

SINGLE ROW



SINGLE ROW WITH FLANGE

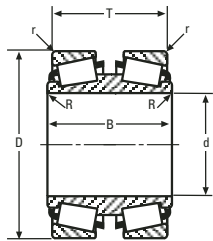

DOUBLE CONE

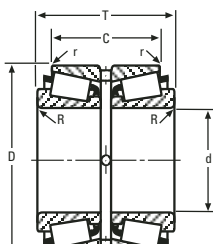

DOUBLE CUP

CONE			Max Shaft Fillet Radii R <sup>**</sup>	Weight	CUP			Max Hs'ng Fillet Radii r <sup>**</sup>	Weight	BEAR-ING	Remarks
Number	BORE d	WIDTH B			Number	OUTSIDE DIA D	WIDTH C			WIDTH T	
<b>07000 Series (cont)</b>											
07096	25.159 .9905	14.260 .5614	1.5 .06	.08 kg .18 lb	07205	52.000 2.0472	12.700 .5000	2.0 .08	.06 kg .13 lb	15.011 .5910	07210XB: FLANGE ON OD FRONTFACE, BEARING WIDTH IS T1 DIMENSION
07097	25.000 .9843	14.260 .5614	1.5 .06	.08 kg .18 lb	*07205-B	52.000 2.0472	12.700 .5000	1.5 .06	.07 kg .15 lb	5.080 .2000	
07098	24.981 .9835	14.260 .5614	1.5 .06	.08 kg .18 lb	07205X	51.986 2.0467	13.000 .5118	1.5 .06	.07 kg .14 lb	16.249 .6397	
07098W	24.981 .9835	14.260 .5614	1.5 .06	.08 kg .18 lb	07210X	50.800 2.0000	12.700 .5000	1.5 .06	.05 kg .11 lb	15.011 .5910	
07099	25.273 .9950	14.260 .5614	1.5 .06	.08 kg .18 lb	*07210XB	50.800 2.0000	12.700 .5000	1.5 .06	.06 kg .13 lb	5.080 .2000	
07100	25.400 1.0000	14.260 .5614	1.0 .04	.08 kg .18 lb							
07100-S	25.400 1.0000	14.260 .5614	1.5 .06	.08 kg .18 lb							
07100-SA	25.400 1.0000	14.260 .5614	3.3 .13	.08 kg .17 lb							
07100W	25.400 1.0000	14.260 .5614	1.0 .04	.08 kg .18 lb							
07100D	25.400 1.0000	36.512 1.4375	.8 .03	.22 kg .48 lb	07196	50.005 1.9687	9.525 .3750	1.0 .04	.03 kg .08 lb	27.046 1.0648	
07101DW	25.400 1.0000	36.512 1.4375	.8 .03	.22 kg .48 lb	07204	51.994 2.0470	12.700 .5000	1.3 .05	.06 kg .13 lb	30.079 1.1842	
					07205	52.000 2.0472	12.700 .5000	2.0 .08	.06 kg .13 lb	30.079 1.1842	
					07205X	51.986 2.0467	13.000 .5118	1.5 .06	.07 kg .14 lb	32.553 1.2816	
					07210X	50.800 2.0000	12.700 .5000	1.5 .06	.05 kg .11 lb	30.079 1.1842	
<b>08000 Series</b>											
08118	30.162 1.1875	15.080 .5937	3.5 .14	.11 kg .25 lb	*08231-B	58.738 2.3125	10.716 .4219	1.0 .04	.06 kg .13 lb	6.736 .2652	08118DA: ASYMMETRICAL BEARING HOLES IN OD LEFTFACE
08125	31.750 1.2500	15.080 .5937	1.0 .04	.11 kg .24 lb	08231	58.738 2.3125	10.716 .4219	1.0 .04	.06 kg .12 lb	14.683 .5781	08118DAA: ASYMMETRICAL BEARING HOLES IN OD LEFTFACE
08125W	31.750 1.2500	15.080 .5937	1.0 .04	.11 kg .24 lb	*08231D	58.738 2.3125	24.608 .9688	.4 .02	.13 kg .29 lb	32.542 1.2812	08118DE: EXTENDED SMALL RIB HOLES IN OD RIGHTFACE
					08237	58.788 2.3145	10.716 .4219	1.0 .04	.06 kg .12 lb	14.683 .5781	08118DEE: EXTENDED SMALL RIB
*08118DA	30.162 1.1875	60.325 2.3750	.8 .03	.40 kg .88 lb	08231	58.738 2.3125	10.716 .4219	1.0 .04	.06 kg .12 lb	29.154 1.1478	08125DA: ASYMMETRICAL BEARING HOLES IN OD LEFTFACE
*08118DAA	30.162 1.1875	60.325 2.3750	.8 .03	.40 kg .88 lb	08237	58.788 2.3145	10.716 .4219	1.0 .04	.06 kg .12 lb	29.154 1.1478	08125DAA: ASYMMETRICAL BEARING HOLES IN OD LEFTFACE
*08118DE	30.162 1.1875	69.850 2.7500	.8 .03	.44 kg .98 lb							08125DE: EXTENDED SMALL RIB
*08118DEE	30.162 1.1875	69.850 2.7500	.8 .03	.44 kg .98 lb							08125DEE: EXTENDED SMALL RIB
*08125DA	31.750 1.2500	60.325 2.3750	.8 .03	.36 kg .80 lb							08231-B : FLANGE ON OD FRONTFACE, BEARING WIDTH IS T1 DIMENSION
*08125DAA	31.750 1.2500	60.325 2.3750	.8 .03	.36 kg .80 lb							08231D : GROOVE IN OD CENTER HOLES IN OD CENTER
*08125DE	31.750 1.2500	69.850 2.7500	.8 .03	.41 kg .90 lb							
*08125DEE	31.750 1.2500	69.850 2.7500	.8 .03	.41 kg .90 lb							
NA08125	31.750 1.2500	16.271 .6406	1.5 .06	- -	*08231D	58.738 2.3125	24.608 .9688	.4 .02	.13 kg .29 lb	32.542 1.2812	
<b>09000 Series</b>											
09062	15.875 .6250	21.539 .8480	.8 .03	.13 kg .29 lb	09194	49.225 1.9380	17.462 .6875	3.5 .14	.08 kg .17 lb	23.020 .9063	09070: BACKFACE CHAMFER FRONTFACE CHAMFER
*09070	17.653 .6950	21.539 .8480	spcl. spcl.	.12 kg .27 lb	09194-S	52.883 2.0820	14.684 .5781	3.3 .13	.10 kg .21 lb	20.241 .7969	09072W: FRONTFACE CHAMFER KEYWAY IN BACKFACE
*09072W	18.313 .7210	21.539 .8480	.8 .03	.10 kg .23 lb	09195	49.225 1.9380	14.288 .5625	1.3 .05	.06 kg .14 lb	19.845 .7813	

09000 SERIES CONTINUED ON NEXT PAGE

\*\*These Maximum Fillet Radii will be cleared by the Cone or Cup Radii.  
†Bore or O.D. shown are maximum dimensions. \*See Remarks Column.

4

CONE			Max Shaft Fillet Radii R''	Weight	CUP			Max Hs'ng Fillet Radii r''	Weight	BEAR-ING	Remarks
Number	BORE d	WIDTH B			Number	OUTSIDE DIA D	WIDTH C			WIDTH T	
<b>09000 Series (cont)</b>											
*09073T	19.050 .7500	21.539 .8480	.3 .01	.09 kg .19 lb	*09195AB	49.225 1.9380	14.288 .5625	1.3 .05	.07 kg .16 lb	8.809 .3468	09073T: BROKEN BACKFACE ID FRONTFACE CHAMFER SHOULDER ON ID BACKFACE
*09074	19.050 .7500	21.539 .8480	spcl. spcl.	.12 kg .26 lb	09196	49.225 1.9380	17.462 .6875	1.5 .06	.08 kg .18 lb	23.020 .9063	09074: BACKFACE CHAMFER
*09074A	19.050 .7500	21.539 .8480	spcl. spcl.	- -	09199	49.225 1.9380	27.239 1.0724	1.3 .05	.14 kg .32 lb	32.545 1.2813	09074A: BACKFACE CHAMFER
09078	19.050 .7500	21.539 .8480	1.3 .05	.12 kg .26 lb	09201	50.800 2.0000	17.462 .6875	.5 .02	.09 kg .21 lb	20.637 .8125	09075: BACKFACE CHAMFER
09081	20.625 .8120	21.539 .8480	1.5 .06	.11 kg .24 lb	09207	52.819 2.0795	14.173 .5580	1.5 .06	.10 kg .21 lb	19.731 .7768	EXTENDED LARGE RIB FRONTFACE CHAMFER
*09081-S	20.612 .8115	21.539 .8480	spcl. spcl.	.11 kg .24 lb	*T48651	49.225 1.9380	13.056 .5140	- -	.06 kg .13 lb	19.366 .7625	SHOULDER ON OD BACKFACE THREADED BORE
09067	19.050 .7500	19.050 .7500	1.3 .05	.11 kg .24 lb	09194	49.225 1.9380	17.462 .6875	3.5 .14	.08 kg .17 lb	21.209 .8350	09075: BACKFACE CHAMFER EXTENDED LARGE RIB FRONTFACE CHAMFER SHOULDER ON OD BACKFACE THREADED BORE
					09194-S	52.883 2.0820	14.684 .5781	3.3 .13	.10 kg .21 lb	18.430 .7256	09079: NO SMALL RIB
					09195	49.225 1.9380	14.288 .5625	1.3 .05	.06 kg .14 lb	18.034 .7100	09081-S: BACKFACE CHAMFER
					*09195AB	49.225 1.9380	14.288 .5625	1.3 .05	.07 kg .16 lb	6.998 .2755	09195AB: FLANGE ON OD FRONTFACE, BEARING WIDTH IS T1 DIMENSION
					*09195DB	49.225 1.9380	31.549 1.2421	.8 .03	.17 kg .38 lb	39.042 1.5371	09195DB: FLANGE ON OD RIGHTFACE
					09196	49.225 1.9380	17.462 .6875	1.5 .06	.08 kg .18 lb	21.209 .8350	T48651: BROKEN CORNER ON BACKFACE OD BROKEN CORNER ON FRONTFACE OD
					09199	49.225 1.9380	27.239 1.0724	1.3 .05	.14 kg .32 lb	30.734 1.2100	
					09201	50.800 2.0000	17.462 .6875	.5 .02	.09 kg .21 lb	18.826 .7412	
					09207	52.819 2.0795	14.173 .5580	1.5 .06	.10 kg .21 lb	17.920 .7055	
					*T48651	49.225 1.9380	13.056 .5140	- -	.06 kg .13 lb	17.555 .6912	
*09075	19.000 .7480	22.332 .8792	spcl. spcl.	.13 kg .29 lb	09075 and grouped cones may be paired with all single cups corresponding to 09062 and will require .792 mm (.0312 in) to be added to the T-width values.						
*09076	19.000 .7480	22.332 .8792	spcl. spcl.	.11 kg .23 lb							
*09079	19.050 .7500	17.475 .6880	1.5 .06	- -	09079 may be paired with all single cups corresponding to 09067 and will require .389 mm (.0153 in) to be added to the T-width values.						
09079 may be paired with all double cups corresponding to 09067 and will require .777 mm (.0306 in) to be added to the T-width values.											
<b>JP10000 Series</b>											
†JP10044	95.000 3.7402	22.500 .8858	3.0 .12	.96 kg 2.11 lb	*†JP10010-B	140.000 5.7087	17.500 .6890	3.0 .12	.37 kg .81 lb	10.500 .4134	JP10048: NO LARGE RIB STRAIGHT OD NO SMALL RIB
†JP10049	100.000 3.9370	22.500 .8858	3.0 .12	.82 kg 1.81 lb	†JP10010A	140.000 5.7087	17.500 .6890	.8 .03	.33 kg .73 lb	24.000 .9449	JP10010-B: FLANGE ON OD FRONTFACE, BEARING WIDTH IS T1 DIMENSION
†JP10049A	100.000 3.9370	22.500 .8858	5.0 .20	.82 kg 1.81 lb	†JP10010	140.000 5.7087	17.500 .6890	3.0 .12	.31 kg .69 lb	24.000 .9449	

†These Maximum Fillet Radii will be cleared by the Cone or Cup Radii.  
†Bore or O.D. shown are maximum dimensions. \*See Remarks Column.

JP10000 – M12400 SERIES

4

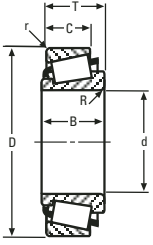

SINGLE ROW

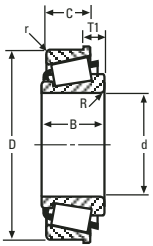

SINGLE ROW WITH FLANGE

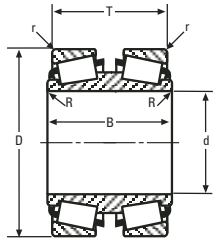

DOUBLE CONE

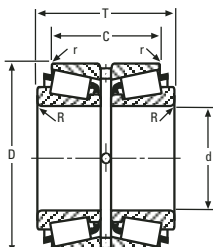

DOUBLE CUP

CONE				Weight	CUP			Weight	BEARING		Remarks
Number	BORE d	WIDTH B	Max Shaft Fillet Radii R <sup>**</sup>		Number	OUTSIDE DIA D	WIDTH C		Max Hs'ng Fillet Radii r <sup>**</sup>	WIDTH T	
<b>JP10000 Series (cont)</b>											
*†JP10048	95.000 3.7402	28.000 1.1024	3.0 .12	- -	JP10048 may be paired with all single cups corresponding to JP10044 and will require -.4785 mm (-.1660 in) to be added to the T-width values.						
†JP10049H	SEE HYDRA-RIB BEARING SECTION				†JP10019HRA	SEE HYDRA-RIB BEARING SECTION					
					†JP10019HR	SEE HYDRA-RIB BEARING SECTION					
<b>11000 Series</b>											
11157	39.980 1.5740	17.384 .6844	1.5 .06	.22 kg .49 lb	*11300-B	76.200 3.0000	14.288 .5625	1.5 .06	.14 kg .32 lb	7.293 .2871	11300-B : FLANGE ON OD FRONTFACE, BEARING WIDTH IS T1 DIMENSION SPECIAL RADIUS ON BACKFACE OD
11157X	40.000 1.5748	17.384 .6844	1.8 .07	.22 kg .49 lb	11300	76.200 3.0000	14.288 .5625	1.5 .06	.13 kg .28 lb	18.009 .7090	
11162	41.275 1.6250	17.384 .6844	1.5 .06	.21 kg .47 lb	11315-S	80.000 3.1496	14.288 .5625	2.0 .08	.18 kg .39 lb	18.009 .7090	
11163	41.275 1.6250	17.384 .6844	.8 .03	.21 kg .47 lb	11315	80.000 3.1496	14.288 .5625	1.5 .06	.18 kg .39 lb	18.009 .7090	
11165X	42.000 1.6535	17.384 .6844	1.8 .07	.20 kg .45 lb							
<b>JP11000 Series</b>											
*†JP11035	SEE HYDRA-RIB BEARING SECTION				*†JP11019HR	SEE HYDRA-RIB BEARING SECTION					
*†JP11048	SEE HYDRA-RIB BEARING SECTION					SEE HYDRA-RIB BEARING SECTION					
<b>11500 Series</b>											
11590	15.875 .6250	14.288 .5625	1.5 .06	.06 kg .13 lb	11520	42.862 1.6875	9.525 .3750	1.5 .06	.04 kg .09 lb	14.287 .5625	
11590A	15.875 .6250	14.288 .5625	3.5 .14	.06 kg .14 lb							
<b>LM11700 Series</b>											
LM11749	17.462 .6875	14.605 .5750	1.3 .05	.06 kg .12 lb	LM11710	39.878 1.5700	10.668 .4200	1.3 .05	.03 kg .06 lb	13.843 .5450	
LM11749F	17.462 .6875	14.605 .5750	1.3 .05	- -							
<b>LM11900 Series</b>											
LM11949	19.050 .7500	16.637 .6550	1.3 .05	- -	LM11910	45.237 1.7810	12.065 .4750	1.3 .05	.04 kg .10 lb	15.494 .6100	LM11919 : CHAMFER ON FRONTFACE OD
LM11949F	19.050 .7500	16.637 .6550	1.3 .05	- -	*LM11919	52.800 2.0787	14.605 .5750	1.3 .05	.12 kg .26 lb	18.034 .7100	
<b>12000 Series</b>											
12168	42.862 1.6875	17.145 .6750	1.5 .06	.23 kg .50 lb	*12303-B	76.992 3.0312	11.908 .4688	1.5 .06	.11 kg .24 lb	9.126 .3593	12303-B : FLANGE ON OD FRONTFACE, BEARING WIDTH IS T1 DIMENSION SPECIAL RADIUS ON BACKFACE OD
12175	44.450 1.7500	17.145 .6750	1.5 .06	.21 kg .47 lb	12303	76.992 3.0312	11.908 .4688	1.5 .06	.10 kg .21 lb	17.464 .6876	
<b>JP12000 Series</b>											
*†JP12049	120.000 4.7244	25.000 .9843	3.0 .12	1.25 kg 2.76 lb	†JP12010	170.000 6.6929	19.500 .7677	3.0 .12	.48 kg 1.07 lb	27.000 1.0630	JP12049: FRONTFACE CHAMFER JP12049A: FRONTFACE CHAMFER
*†JP12049A	120.000 4.7244	25.000 .9843	6.0 .24	1.23 kg 2.71 lb							
†JP12043P	SEE HYDRA-RIB BEARING SECTION				†JP12019HR	SEE HYDRA-RIB BEARING SECTION					
†JP12049P	SEE HYDRA-RIB BEARING SECTION					SEE HYDRA-RIB BEARING SECTION					
<b>M12400 Series</b>											
M12430					M12411DB	SEE MULTI-ROW STEERING GEAR BEARING SECTION					
M12431	SEE MULTI-ROW STEERING GEAR BEARING SECTION										
M12448											

12500 SERIES CONTINUED ON NEXT PAGE

\*\*These Maximum Fillet Radii will be cleared by the Cone or Cup Radii.  
†Bore or O.D. shown are maximum dimensions. \*See Remarks Column.

4

CONE			Max Shaft Fillet Radii R''	Weight	CUP			Max Hs'ng Fillet Radii r''	Weight	BEARING	Remarks
Number	BORE d	WIDTH B			Number	OUTSIDE DIA D	WIDTH C			WIDTH T	
<b>12500 Series</b>											
12580	20.638 .8125	19.845 .7813	1.5 .06	.12 kg .26 lb	12520 *T70335	49.225 1.9380 76.200 3.0000	15.875 .6250 46.833 1.8438	1.5 .06 5.0 .20	.07 kg .15 lb 1.12 kg 2.48 lb	19.845 .7813 43.663 1.7190	NA12581-SW: FRONTFACE CHAMFER SLOTS IN FRONTFACE T70335 : SPECIAL RADIUS ON LEFTFACE OD SPECIAL RADIUS ON RIGHTFACE OD
*NA12581-SW	20.638 .8125	24.211 .9532	1.5 .06	.29 kg .65 lb	K38958 *T70335	76.200 3.0000 76.200 3.0000	46.833 1.8438 46.833 1.8438	3.3 .13 5.0 .20	1.12 kg 2.48 lb 1.12 kg 2.48 lb	48.423 1.9064 48.423 1.9064	
<b>M12600 Series</b>											
M12648	22.225 .8750	18.288 .7200	1.3 .05	.11 kg .23 lb	M12610	50.005 1.9687	13.970 .5500	1.3 .05	.06 kg .13 lb	17.526 .6900	
M12648A	22.225 .8750	18.288 .7200	.4 .01	.11 kg .23 lb							
M12649	21.430 .8437	18.288 .7200	1.3 .05	.11 kg .24 lb							
M12649F	21.430 .8437	18.288 .7200	1.3 .05	- -							
M12649X	21.430 .8437	18.288 .7200	3.5 .14	.11 kg .24 lb							
<b>LM12700 Series</b>											
LM12748	21.430 .8437	16.637 .6550	1.3 .05	- -	LM12710	45.237 1.7810	12.065 4.750	1.3 .05	.04 kg .08 lb	15.494 .6100	JLM12712-B: FLANGE ON OD FRONTFACE, BEARING WIDTH IS T1 DIMENSION SPECIAL RADIUS ON BACKFACE OD
LM12748F	21.430 .8437	16.637 .6550	1.3 .05	.08 kg .17 lb	LM12710P	45.237 1.7810	12.065 4.750	1.3 .05	.04 kg .08 lb	15.494 .6100	
LM12749	21.986 .8656	16.637 .6550	1.3 .05	- -	LM12711	45.974 1.8100	12.065 4.750	1.3 .05	.04 kg .09 lb	15.494 .6100	
LM12749F	21.986 .8656	16.637 .6550	1.3 .05	.07 kg .16 lb	*JLM12712-B	45.000 1.7717	12.065 4.750	spcl. spcl.	.05 kg .11 lb	6.429 .2531	
LM12749FP	21.986 .8656	16.637 .6550	1.3 .05	.07 kg .16 lb							
<b>13000 Series</b>											
13169D	42.862 1.6875	31.750 1.2500	.8 .03	.59 kg 1.31 lb	13318	80.962 3.1875	14.288 .5625	1.5 .06	.14 kg .31 lb	34.925 1.3750	
13176D	44.450 1.7500	31.750 1.2500	.1 .01	.57 kg 1.25 lb							
13182D	46.038 1.8125	31.750 1.2500	.8 .03	.55 kg 1.22 lb							
13175	44.450 1.7500	17.462 .6875	.1 .01	.24 kg .54 lb	13318	80.962 3.1875	14.288 .5625	1.5 .06	.14 kg .31 lb	19.050 .7500	
13181	46.038 1.8125	17.462 .6875	.8 .03	.23 kg .51 lb							
<b>JP13000 Series</b>											
†JP13049	130.000 5.1181	27.000 1.0630	3.0 .12	1.58 kg 3.47 lb	*†JP13010-B	185.000 7.2835	21.000 .8268	3.0 .12	.67 kg 1.48 lb	13.000 .5118	JP13010-B : FLANGE ON OD FRONTFACE, BEARING WIDTH IS T1 DIMENSION
†JP13049A	130.000 5.1181	27.000 1.0630	6.0 .24	1.56 kg 3.45 lb	†JP13010	185.000 7.2835	21.000 .8268	3.0 .12	.59 kg 1.30 lb	29.000 1.1417	
†JP13043P	SEE HYDRA-RIB BEARING SECTION				†JP13016HR	SEE HYDRA-RIB BEARING SECTION					
†JP13049P	SEE HYDRA-RIB BEARING SECTION										
<b>13600 Series</b>											
*13677-SD	39.548 1.5570	85.725 3.3750	.4 .01	.77 kg 1.69 lb	13620	69.012 2.7170	15.083 .5938	.8 .03	.10 kg .23 lb	41.275 1.6250	13677-SD: SQUARE BORE 13678-SD: SQUARE BORE
*13678-SD	39.548 1.5570	73.025 2.8750	.4 .01	.69 kg 1.52 lb	13621 13621A *13623X 13624	69.012 2.7170 69.012 2.7170 69.012 2.7170 69.969 2.7547	15.083 .5938 15.083 .5938 14.321 .5638 18.463 .7269 18.029 .7098	2.3 .09 2.3 .09 .4 .02 1.5 .06	.10 kg .22 lb .09 kg .20 lb .14 kg .30 lb .15 kg .33 lb	41.275 1.6250 39.751 1.5650 48.036 1.8912 47.168 1.8570	13686 : EXTENDED LARGE RIB 13621D : GROOVE IN OD CENTER HOLES IN OD CENTER 13621DC: HOLES IN OD CENTER

†These Maximum Fillet Radii will be cleared by the Cone or Cup Radii.  
†Bore or O.D. shown are maximum dimensions. \*See Remarks Column.

13600 – 14000 SERIES

4

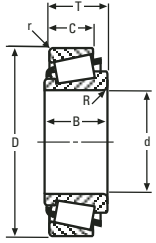

SINGLE ROW



SINGLE ROW WITH FLANGE

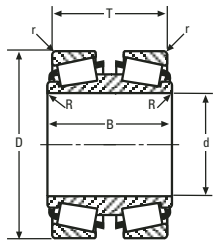

DOUBLE CONE

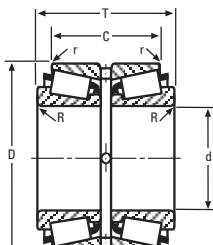

DOUBLE CUP

CONE			Max Shaft Fillet Radii R <sup>**</sup>	Weight	CUP			Max Hs'ng Fillet Radii r <sup>**</sup>	Weight	BEARING	Remarks
Number	BORE d	WIDTH B			Number	OUTSIDE DIA D	WIDTH C			WIDTH T	
<b>13600 Series (cont)</b>											
13682	36.512 1.4375	19.050 .7500	3.5 .14	.20 kg .43 lb	13620	69.012 2.7170	15.083 .5938	.8 .03	.10 kg .23 lb	19.050 .7500	13623X: GROOVE IN OD BACKFACE
13685	38.100 1.5000	19.050 .7500	3.5 .14	.18 kg .40 lb	13621	69.012 2.7170	15.083 .5938	2.3 .09	.10 kg .22 lb	19.050 .7500	
13685A	38.100 1.5000	19.050 .7500	.8 .03	.19 kg .41 lb	13621A	69.012 2.7170	14.321 .5638	2.3 .09	.09 kg .20 lb	18.288 .7200	
13685W	38.100 1.5000	19.050 .7500	3.5 .14	.19 kg .42 lb	*13621D	69.012 2.7170	38.100 1.5000	.8 .03	.27 kg .59 lb	46.206 1.8191	
13687	38.100 1.5000	19.050 .7500	2.0 .08	.19 kg .41 lb	*13621DC	69.012 2.7170	38.100 1.5000	.8 .03	.29 kg .64 lb	46.035 1.8124	
					*13623X	69.012 2.7170	18.463 .7269	.4 .02	.14 kg .30 lb	22.431 .8831	
					13624	69.969 2.7547	18.029 .7098	1.5 .06	.15 kg .33 lb	21.996 .8660	
NA13687	38.100 1.5000	23.017 .9062	2.0 .08	.41 kg .89 lb	*13621D	69.012 2.7170	38.100 1.5000	.8 .03	.27 kg .59 lb	46.035 1.8124	
					*13621DC	69.012 2.7170	38.100 1.5000	.8 .03	.29 kg .64 lb	46.035 1.8124	
*13686	38.100 1.5000	26.195 1.0313	1.5 .06	.25 kg .54 lb	13686 may be paired with all single cups corresponding to 13682 and will require 7.145 mm (.2813 in) to be added to the T-width values. 13686 may be paired with all double cups corresponding to 13682 and will require 14.290 mm (.5626 in) to be added to the T-width values.						
<b>13800 Series</b>											
13889	38.100 1.5000	11.908 .4688	1.5 .06	- -	13830	63.500 2.5000	9.525 .3750	.8 .03	.04 kg .10 lb	12.700 .5000	13835D : GROOVE IN OD CENTER HOLES IN OD CENTER
13890	38.481 1.5150	11.908 .4688	.4 .01	- -	13830CP	63.500 2.5000	9.525 .3750	.8 .03	- -	12.700 .5000	13836-B: FLANGE ON OD FRONTFACE, BEARING WIDTH IS T1 DIMENSION
					*13835D	63.500 2.5000	31.750 1.2500	.4 .02	.17 kg .38 lb	38.100 1.5000	
					13836	65.088 2.5625	9.525 .3750	.8 .03	.06 kg .12 lb	12.700 .5000	
					*13836-B	65.088 2.5625	9.525 .3750	.8 .03	.06 kg .14 lb	5.944 .2340	
<b>14000 Series</b>											
14116	30.226 1.1900	19.583 .7710	.8 .03	.23 kg .51 lb	14272	69.012 2.7170	14.288 .5625	3.3 .13	.11 kg .25 lb	19.050 .7500	14117A: FRONTFACE CHAMFER 14118: FRONTFACE CHAMFER
14116W	30.226 1.1900	19.583 .7710	.8 .03	.22 kg .49 lb	*14273	69.012 2.7170	16.954 .6675	spcl. spcl.	.11 kg .25 lb	19.337 .7613	
*14117A	30.000 1.1811	19.583 .7710	3.5 .14	.23 kg .51 lb	14274	69.012 2.7170	15.875 .6250	3.3 .13	.13 kg .28 lb	19.845 .7813	14118DA: ASYMMETRICAL BEARING EXTENDED SMALL RIB HOLES IN OD RIGHTFACE
*14118	30.000 1.1811	19.202 .7560	.8 .03	.23 kg .50 lb	14274A	68.956 2.7148	15.875 .6250	3.3 .13	.12 kg .28 lb	19.845 .7813	14119A: FRONTFACE CHAMFER
14118A	30.000 1.1811	19.583 .7710	3.5 .14	.23 kg .51 lb	14274-S	75.311 2.9650	15.875 .6250	3.3 .13	.21 kg .47 lb	19.845 .7813	14120: EXTENDED LARGE RIB SHOULDER ON OD BACKFACE
14118AS	29.987 1.1806	19.202 .7560	.8 .03	.23 kg .51 lb	14275A	69.850 2.7500	15.875 .6250	1.5 .06	.14 kg .32 lb	19.845 .7813	
*14119A	30.226 1.1900	19.583 .7710	.8 .03	.23 kg .50 lb	14276	69.012 2.7170	15.875 .6250	1.3 .05	.13 kg .29 lb	19.845 .7813	14120A: EXTENDED LARGE RIB SHOULDER ON OD BACKFACE
*14123T	31.750 1.2500	19.583 .7710	1.5 .06	.21 kg .47 lb	*14276-B	69.012 2.7170	15.875 .6250	.8 .03	.14 kg .32 lb	7.932 .3123	14121: EXTENDED LARGE RIB
14124	31.750 1.2500	19.583 .7710	.8 .03	.22 kg .49 lb	*14276D	69.012 2.7170	38.100 1.5000	.8 .03	.30 kg .67 lb	46.040 1.8126	14123A: EXTENDED LARGE RIB SHOULDER ON OD BACKFACE
14124C	31.750 1.2500	19.583 .7710	.8 .03	.22 kg .48 lb	14277	69.012 2.7170	18.415 .7250	2.3 .09	.16 kg .35 lb	22.385 .8813	14123AA: EXTENDED LARGE RIB SHOULDER ON OD BACKFACE
14125A	31.750 1.2500	19.583 .7710	3.5 .14	.22 kg .48 lb	14282	71.996 2.8345	15.032 .5918	1.5 .06	.16 kg .36 lb	19.002 .7481	14123DA: ASYMMETRICAL BEARING HOLES IN OD RIGHTFACE
14125W	31.750 1.2500	19.583 .7710	3.5 .14	.21 kg .47 lb	14283	72.085 2.8380	18.415 .7250	2.3 .09	.21 kg .46 lb	22.385 .8813	14123T: TAPERED BORE
14130	33.338 1.3125	19.583 .7710	3.5 .14	.21 kg .45 lb	14284	71.996 2.8345	18.415 .7250	2.3 .09	.21 kg .46 lb	22.385 .8813	
14130X	33.338 1.3125	19.583 .7710	1.5 .06	.21 kg .45 lb	14299	77.788 3.0625	15.875 .6250	1.3 .05	.26 kg .57 lb	19.845 .7813	

14000 SERIES CONTINUED ON NEXT PAGE

\*\*These Maximum Fillet Radii will be cleared by the Cone or Cup Radii.  
†Bore or O.D. shown are maximum dimensions. \*See Remarks Column.

4

CONE			Max Shaft Fillet Radii R <sup>†</sup>	Weight	CUP			Max Hs'ng Fillet Radii r <sup>†</sup>	Weight	BEAR-ING	Remarks
Number	BORE d	WIDTH B			Number	OUTSIDE DIA D	WIDTH C			WIDTH T	
14000 Series (cont)											
14131	33.338 1.3125	19.583 .7710	.8 .03	.21 kg .46 lb						14132T: TAPERED BORE	
14131A	33.338 1.3125	19.583 .7710	.8 .03	.20 kg .45 lb						14136A: EXTENDED LARGE RIB SHOULDER ON OD BACKFACE	
*14132T	33.338 1.3125	19.583 .7710	1.5 .06	.20 kg .45 lb						14136AA: EXTENDED LARGE RIB SHOULDER ON OD BACKFACE	
14137A	34.925 1.3750	19.583 .7710	1.5 .06	.19 kg .43 lb							
14137AS	34.925 1.3750	19.583 .7710	.5 .02	.19 kg .43 lb						14273 : SPECIAL CHAMFER ON BACKFACE OD	
14138A	34.925 1.3750	19.583 .7710	3.5 .14	.19 kg .42 lb						14276-B : FLANGE ON OD FRONTFACE, BEARING WIDTH IS T1 DIMENSION	
14139	34.976 1.3770	19.583 .7710	1.3 .05	.19 kg .43 lb						14276D : GROOVE IN OD CENTER HOLES IN OD CENTER	
14139X	35.000 1.3780	19.583 .7710	3.5 .14	.19 kg .42 lb							
14125DW	31.750 1.2500	49.200 1.9370	.8 .03	.61 kg 1.34 lb	14272	69.012 2.7170	14.288 .5625	3.3 .13	.11 kg .25 lb	38.115 1.5006	
14126D	31.750 1.2500	39.182 1.5426	1.5 .06	.53 kg 1.17 lb	*14273	69.012 2.7170	16.954 .6675	spcl. spcl.	.11 kg .25 lb	38.689 1.5232	
14134D	33.338 1.3125	39.182 1.5426	1.5 .06	.50 kg 1.11 lb	14274	69.012 2.7170	15.875 .6250	3.3 .13	.13 kg .28 lb	39.705 1.5632	
					14274A	68.956 2.7148	15.875 .6250	3.3 .13	.12 kg .28 lb	39.705 1.5632	
					14274-S	75.311 2.9650	15.875 .6250	3.3 .13	.21 kg .47 lb	39.705 1.5632	
					14275A	69.850 2.7500	15.875 .6250	1.5 .06	.14 kg .32 lb	39.705 1.5632	
					14276	69.012 2.7170	15.875 .6250	1.3 .05	.13 kg .29 lb	39.705 1.5632	
					14277	69.012 2.7170	18.415 .7250	2.3 .09	.16 kg .35 lb	44.785 1.7632	
					14282	71.996 2.8345	15.032 .5918	1.5 .06	.16 kg .36 lb	38.019 1.4968	
					14283	72.085 2.8380	18.415 .7250	2.3 .09	.21 kg .46 lb	44.785 1.7632	
					14284	71.996 2.8345	18.415 .7250	2.3 .09	.21 kg .46 lb	44.785 1.7632	
					14299	77.788 3.0625	15.875 .6250	1.3 .05	.26 kg .57 lb	39.705 1.5632	
NA14138	34.925 1.3750	23.020 .9063	3.5 .14	.41 kg .90 lb	*14276D	69.012 2.7170	38.100 1.5000	.8 .03	.30 kg .67 lb	46.040 1.8126	
*14118DA	30.162 1.1875	75.425 2.9695	.8 .03	.85 kg 1.86 lb	14118DA and grouped cones may be paired with all single cups corresponding to 14125DW and will require -.018 mm (-.0007 in) to be added to the T-width values.						
*14123DA	31.750 1.2500	75.425 2.9695	.8 .03	.80 kg 1.76 lb							
*14120	30.226 1.1900	26.721 1.0520	4.3 .17	.27 kg .59 lb	14120 and grouped cones may be paired with all single cups corresponding to 14116 and will require 7.137 mm (.2810 in) to be added to the T-width values.						
*14120A	30.000 1.1811	26.721 1.0520	3.5 .14	.27 kg .60 lb	14120 and grouped cones may be paired with all double cups corresponding to 14116 and will require 14.275 mm (.5620 in) to be added to the T-width values.						
*14123A	31.750 1.2500	26.721 1.0520	4.3 .17	.26 kg .56 lb							
*14123AA	31.750 1.2500	26.721 1.0520	4.3 .17	.26 kg .56 lb							
*14136A	34.925 1.3750	26.721 1.0520	.8 .03	.22 kg .49 lb							
*14136AA	34.925 1.3750	26.721 1.0520	.8 .03	.22 kg .49 lb							

<sup>†</sup>These Maximum Fillet Radii will be cleared by the Cone or Cup Radii.  
<sup>†</sup>Bore or O.D. shown are maximum dimensions. \*See Remarks Column.

14000 – 15000 SERIES

4

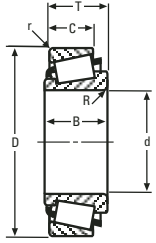

SINGLE ROW



SINGLE ROW WITH FLANGE

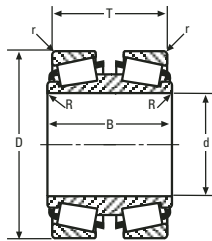

DOUBLE CONE

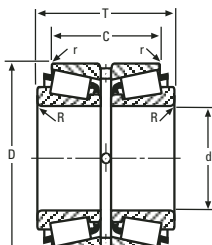

DOUBLE CUP

CONE				Weight	CUP			Weight	BEARING		Remarks
Number	BORE d	WIDTH B	Max Shaft Fillet Radii R**		Number	OUTSIDE DIA D	WIDTH C		Max Hs'ng Fillet Radii r**	WIDTH T	
<b>14000 Series (cont)</b>											
*14121	30.226 1.1900	25.933 1.0210	.8 .03	.26 kg .58 lb	14121 may be paired with all single cups corresponding to 14116 and will require 6.350 mm (.2500 in) to be added to the T-width values. 14121 may be paired with all double cups corresponding to 14116 and will require 12.700 mm (.5000 in) to be added to the T-width values.						
<b>JP14000 Series</b>											
†JP14049	140.000 5.5118	27.000 1.0630	3.0 .12	1.68 kg 3.71 lb	†JP14010	195.000 7.6772	21.000 .8268	3.0 .12	.62 kg 1.38 lb	29.000 1.1417	JP14010-B : FLANGE ON OD FRONTFACE, BEARING WIDTH IS T1 DIMENSION
					*†JP14010-B	195.000 7.6772	21.000 .8268	3.0 .12	.73 kg 1.62 lb	13.000 0.5118	
†JP14043P	SEE HYDRA-RIB BEARING SECTION				†JP14019HR	SEE HYDRA-RIB BEARING SECTION					
†JP14049P	SEE HYDRA-RIB BEARING SECTION										
<b>14500 Series</b>											
14585	34.925 1.3750	20.638 .8125	3.5 .14	.20 kg .44 lb	14525	68.262 2.6875	15.875 .6250	2.3 .09	.12 kg .27 lb	20.638 .8125	
<b>15000 Series</b>											
15100	25.400 1.0000	20.638 .8125	3.5 .14	.21 kg .47 lb	15243	61.912 2.4375	14.288 .5625	2.0 .08	.08 kg .17 lb	19.050 .7500	NA15117-SW: FRONTFACE CHAMFER SLOTS IN FRONTFACE
15100-S	25.400 1.0000	20.638 .8125	1.3 .05	.21 kg .47 lb	15244	62.000 2.4409	15.875 .6250	1.3 .05	.09 kg .21 lb	20.637 .8125	NA15118-SW: FRONTFACE CHAMFER SLOTS IN FRONTFACE
15101	25.400 1.0000	20.638 .8125	.8 .03	.22 kg .47 lb	15244X	62.000 2.4409	15.875 .6250	1.5 .06	.09 kg .20 lb	20.637 .8125	15121T: TAPERED BORE
15102	25.400 1.0000	20.638 .8125	1.5 .06	.21 kg .47 lb	15245	62.000 2.4409	14.288 .5625	1.3 .05	.08 kg .18 lb	19.050 .7500	15123: SPECIAL BACKFACE RADIUS
15103	26.157 1.0298	20.638 .8125	.8 .03	.21 kg .46 lb	15249	63.500 2.5000	15.875 .6250	1.5 .06	.11 kg .24 lb	20.637 .8125	15125T: TAPERED BORE
15103-S	26.162 1.0300	19.939 .7850	.8 .03	.21 kg .47 lb	15250	63.500 2.5000	15.875 .6250	1.3 .05	.11 kg .24 lb	20.637 .8125	NA15125-SW: FRONTFACE CHAMFER SHOULDER ON OD BACKFACE SLOTS IN FRONTFACE
15106	26.988 1.0625	20.638 .8125	.8 .03	.20 kg .45 lb	*15250-B	63.500 2.5000	15.875 .6250	1.3 .05	.13 kg .28 lb	8.730 .3437	15250-B : FLANGE ON OD FRONTFACE, BEARING WIDTH IS T1 DIMENSION
15112	28.575 1.1250	20.638 .8125	3.5 .14	.19 kg .42 lb	15250R	63.500 2.5000	14.288 .5625	1.3 .05	.10 kg .21 lb	19.050 .7500	15250RB : GROOVE IN OD FRONTFACE
15113	28.575 1.1250	20.638 .8125	.8 .03	.19 kg .43 lb	*15250RB	63.500 2.5000	15.875 .6250	1.3 .05	.11 kg .25 lb	20.637 .8125	15251D : GROOVE IN OD CENTER HOLES IN OD CENTER
15116	30.112 1.1855	20.638 .8125	.8 .03	.18 kg .40 lb	15250X	63.500 2.5000	15.875 .6250	1.5 .06	.11 kg .24 lb	20.637 .8125	K33867 : SPECIAL RADIUS ON LEFTFACE OD SPECIAL RADIUS ON RIGHTFACE OD
15117	29.987 1.1806	20.638 .8125	1.3 .05	.18 kg .40 lb	*15251D	63.500 2.5000	36.512 1.4375	.8 .03	.27 kg .59 lb	46.037 1.8125	T70125 : SPECIAL RADIUS ON LEFTFACE OD SPECIAL RADIUS ON RIGHTFACE OD
15117X	30.000 1.1811	20.638 .8125	1.5 .06	.18 kg .40 lb	15287XD	73.025 2.8750	38.100 1.5000	.8 .03	.55 kg 1.21 lb	42.669 1.6799	
15118	30.213 1.1895	20.638 .8125	3.5 .14	.18 kg .39 lb	*T70125	88.900 3.5000	49.212 1.9375	spcl. spcl.	1.40 kg 3.09 lb	46.291 1.8225	
15119	30.213 1.1895	20.638 .8125	1.5 .06	.18 kg .40 lb							
15120	30.213 1.1895	20.638 .8125	.8 .03	.18 kg .40 lb							
15120A	30.175 1.1880	20.638 .8125	.5 .02	.18 kg .40 lb							
15125	31.750 1.2500	20.638 .8125	3.5 .14	.16 kg .36 lb							
*15125T	31.750 1.2500	20.638 .8125	1.5 .06	.17 kg .38 lb							
15126	31.750 1.2500	20.638 .8125	.8 .03	.17 kg .37 lb							
*NA15125-SW	31.750 1.2500	22.225 .8750	2.3 .09	- -	*15251D	63.500 2.5000	36.512 1.4375	.8 .03	.27 kg .59 lb	44.450 1.7500	
					15287XD	73.025 2.8750	38.100 1.5000	.8 .03	.55 kg 1.21 lb	44.450 1.7500	
					*K33867	88.900 3.5000	49.212 1.9375	spcl. spcl.	1.40 kg 3.09 lb	44.450 1.7500	
					*T70125	88.900 3.5000	49.212 1.9375	spcl. spcl.	1.40 kg 3.09 lb	44.450 1.7500	

15000 SERIES CONTINUED ON NEXT PAGE

\*\*These Maximum Fillet Radii will be cleared by the Cone or Cup Radii.  
†Bore or O.D. shown are maximum dimensions. \*See Remarks Column.



4

CONE			Max Shaft Fillet Radii R''	Weight	CUP			Max Hs'ng Fillet Radii r''	Weight	BEAR-ING	Remarks
Number	BORE d	WIDTH B			Number	OUTSIDE DIA D	WIDTH C			WIDTH T	
<b>15000 Series (cont)</b>											
					<b>K154600</b>	<b>83.500</b> 3.2874	<b>49.212</b> 1.9375	<b>3.3</b> .13	<b>1.18 kg</b> 2.60 lb	<b>44.450</b> 1.7500	
					<b>K426867</b>	<b>85.725</b> 3.3750	<b>49.212</b> 1.9375	<b>3.3</b> .13	<b>1.23 kg</b> 2.72 lb	<b>44.450</b> 1.7500	
<b>15100-SR</b>	<b>25.400</b> 1.0000	<b>19.050</b> .7500	<b>1.3</b> .05	<b>.20 kg</b> .45 lb	15100-SR and grouped cones may be paired with all single cups corresponding to 15100 and will require -.889 mm (-.0350 in) to be added to the T-width values.						
<b>15112R</b>	<b>28.575</b> 1.1250	<b>19.050</b> .7500	<b>3.5</b> .14	<b>.18 kg</b> .39 lb	15100-SR and grouped cones may be paired with all double cups corresponding to 15100 and will require -1.778 mm (-.0700 in) to be added to the T-width values.						
<b>15115</b>	<b>29.987</b> 1.1806	<b>19.050</b> .7500	<b>1.3</b> .05	<b>.17 kg</b> .38 lb							
<b>15118R</b>	<b>30.213</b> 1.1895	<b>19.050</b> .7500	<b>3.5</b> .14	<b>.17 kg</b> .37 lb							
<b>*15121T</b>	<b>30.958</b> 1.2188	<b>19.050</b> .7500	<b>1.5</b> .06	<b>.16 kg</b> .36 lb							
<b>*15123</b>	<b>31.750</b> 1.2500	<b>19.050</b> .7500	<b>spcl.</b> spcl.	<b>.15 kg</b> .33 lb							
<b>*NA15117-SW</b>	<b>30.005</b> 1.1813	<b>25.400</b> 1.0000	<b>.8</b> .03	<b>.46 kg</b> 1.01 lb	NA15117-SW may be paired with all double cups corresponding to NA15125-SW and will require 6.350 mm (.2500 in) to be added to the T-width values.						
<b>*NA15118-SW</b>	<b>30.000</b> 1.1811	<b>25.375</b> .9990	<b>3.5</b> .14	<b>.46 kg</b> 1.01 lb	NA15118-SW may be paired with all double cups corresponding to NA15125-SW and will require 6.300 mm (.2480 in) to be added to the T-width values.						
<b>15500 Series</b>											
<b>*15575T</b>	<b>23.812</b> .9375	<b>17.462</b> .6875	<b>1.5</b> .06	<b>.16 kg</b> .34 lb	<b>*15520-B</b>	<b>57.150</b> 2.2500	<b>13.495</b> .5313	<b>1.5</b> .06	<b>.09 kg</b> .20 lb	<b>7.937</b> .3125	15575T: TAPERED BORE
<b>15578</b>	<b>25.400</b> 1.0000	<b>17.462</b> .6875	<b>1.3</b> .05	<b>.15 kg</b> .32 lb	<b>*15520RB</b>	<b>57.150</b> 2.2500	<b>13.495</b> .5313	<b>1.5</b> .06	<b>.07 kg</b> .15 lb	<b>17.462</b> .6875	15520-B : FLANGE ON OD FRONTFACE, BEARING WIDTH IS T1 DIMENSION
<b>15579X</b>	<b>25.987</b> 1.0231	<b>17.462</b> .6875	<b>3.5</b> .14	<b>.14 kg</b> .31 lb	<b>15520</b>	<b>57.150</b> 2.2500	<b>13.495</b> .5313	<b>1.5</b> .06	<b>.07 kg</b> .15 lb	<b>17.462</b> .6875	15520RB : GROOVE IN OD FRONTFACE
<b>15580</b>	<b>26.988</b> 1.0625	<b>17.462</b> .6875	<b>3.5</b> .14	<b>.13 kg</b> .30 lb	<b>15522A</b>	<b>59.530</b> 2.3437	<b>15.083</b> .5938	<b>3.3</b> .13	<b>.10 kg</b> .22 lb	<b>19.446</b> .7656	15523RB : GROOVE IN OD FRONTFACE
<b>†J15585</b>	<b>28.000</b> 1.1024	<b>17.462</b> .6875	<b>3.5</b> .14	<b>.13 kg</b> .29 lb	<b>*15523RB</b>	<b>60.325</b> 2.3750	<b>15.875</b> .6250	<b>1.5</b> .06	<b>.12 kg</b> .26 lb	<b>19.842</b> .7812	
<b>15590</b>	<b>28.575</b> 1.1250	<b>17.462</b> .6875	<b>3.5</b> .14	<b>.12 kg</b> .27 lb	<b>15523</b>	<b>60.325</b> 2.3750	<b>15.875</b> .6250	<b>1.5</b> .06	<b>.12 kg</b> .27 lb	<b>19.842</b> .7812	
<b>15574A</b>	<b>23.812</b> .9375	<b>18.654</b> .7344	<b>.8</b> .03	<b>.16 kg</b> .36 lb	15574A and grouped cones may be paired with all single cups corresponding to 15575T and will require 1.191 mm (.0469 in) to be added to the T-width values.						
<b>15579A</b>	<b>26.162</b> 1.0300	<b>18.654</b> .7344	<b>.8</b> .03	<b>.15 kg</b> .33 lb							
<b>15575X</b>	<b>23.812</b> .9375	<b>18.161</b> .7150	<b>.8</b> .03	<b>.16 kg</b> .36 lb	15575X may be paired with all single cups corresponding to 15575T and will require 1.016 mm (.0400 in) to be added to the T-width values.						
<b>16000 Series</b>											
<b>16131</b>	<b>33.338</b> 1.3125	<b>20.638</b> .8125	<b>3.5</b> .14	<b>.25 kg</b> .56 lb	<b>16282</b>	<b>72.000</b> 2.8346	<b>14.237</b> .5605	<b>1.5</b> .06	<b>.12 kg</b> .27 lb	<b>19.000</b> .7480	16284-B : FLANGE ON OD FRONTFACE, BEARING WIDTH IS T1 DIMENSION
<b>16137</b>	<b>34.925</b> 1.3750	<b>20.638</b> .8125	<b>3.5</b> .14	<b>.24 kg</b> .53 lb	<b>16283</b>	<b>72.238</b> 2.8440	<b>19.050</b> .7500	<b>2.3</b> .09	<b>.18 kg</b> .40 lb	<b>23.813</b> .9375	
<b>16143</b>	<b>36.512</b> 1.4375	<b>20.638</b> .8125	<b>3.5</b> .14	<b>.22 kg</b> .49 lb	<b>*16284-B</b>	<b>72.238</b> 2.8440	<b>15.875</b> .6250	<b>.8</b> .03	<b>.16 kg</b> .35 lb	<b>8.733</b> .3438	
<b>16150</b>	<b>38.100</b> 1.5000	<b>20.638</b> .8125	<b>3.5</b> .14	<b>.21 kg</b> .46 lb	<b>16284</b>	<b>72.238</b> 2.8440	<b>15.875</b> .6250	<b>1.3</b> .05	<b>.14 kg</b> .32 lb	<b>20.638</b> .8125	
<b>16151</b>	<b>38.100</b> 1.5000	<b>20.638</b> .8125	<b>2.3</b> .09	<b>.21 kg</b> .47 lb	<b>†J16285</b>	<b>72.014</b> 2.8352	<b>16.637</b> .6550	<b>.4</b> .02	<b>.15 kg</b> .34 lb	<b>21.400</b> .8425	
<b>†J16154</b>	<b>39.000</b> 1.5354	<b>20.638</b> .8125	<b>3.5</b> .14	<b>.21 kg</b> .46 lb							
<b>JP16000 Series</b>											
<b>†JP16049</b>	<b>160.000</b> 6.2992	<b>30.000</b> 1.1811	<b>3.0</b> .12	<b>2.32 kg</b> 5.12 lb	<b>†JP16010</b>	<b>220.000</b> 8.6614	<b>23.000</b> .9055	<b>3.0</b> .12	<b>.85 kg</b> 1.86 lb	<b>32.000</b> 1.2598	JP16010-B : FLANGE ON OD FRONTFACE, BEARING WIDTH IS T1 DIMENSION
					<b>*†JP16010-B</b>	<b>220.000</b> 8.6614	<b>23.000</b> .9055	<b>3.0</b> .12	<b>1.00 kg</b> 2.20 lb	<b>15.000</b> 0.5906	

†These Maximum Fillet Radii will be cleared by the Cone or Cup Radii.  
†Bore or O.D. shown are maximum dimensions. \*See Remarks Column.

**JP16000 – 17500 SERIES**

**4**

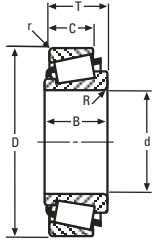

**SINGLE ROW**



**SINGLE ROW WITH FLANGE**

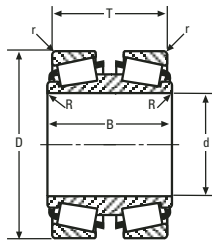

**DOUBLE CONE**

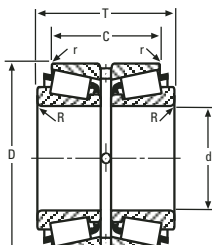

**DOUBLE CUP**

CONE				Weight	CUP				Weight	BEARING		Remarks
Number	BORE d	WIDTH B	Max Shaft Fillet Radii R <sup>**</sup>		Number	OUTSIDE DIA D	WIDTH C	Max Hs'ng Fillet Radii r <sup>**</sup>		WIDTH T	ING T	
<b>JP16000 Series (cont)</b>												
†JP16043P	SEE HYDRA-RIB BEARING SECTION				†JP16019HR	SEE HYDRA-RIB BEARING SECTION						
†JP16049P	SEE HYDRA-RIB BEARING SECTION											
<b>16500 Series</b>												
16579	31.750 1.2500	22.225 .8750	1.5 .06	.25 kg .55 lb	16522	68.262 2.6875	17.462 .6875	.8 .03	.14 kg .30 lb	22.225 .8750		
16582	33.338 1.3125	22.225 .8750	1.5 .06	.23 kg .52 lb								
<b>16900 Series</b>												
16986	42.987 1.6924	19.837 .7810	1.5 .06	.25 kg .56 lb	16929	74.988 2.9523	14.288 .5625	1.3 .05	.10 kg .23 lb	19.367 .7625		
<b>17000 Series</b>												
17098	24.981 .9835	16.566 .6522	1.5 .06	.16 kg .36 lb	17244	62.000 2.4409	14.288 .5625	1.5 .06	.09 kg .20 lb	16.002 .6300	17117TD: TAPERED BORE 17244-B: FLANGE ON OD FRONTFACE, BEARING WIDTH IS T1 DIMENSION	
17098X	25.000 .9843	16.566 .6522	1.5 .06	.16 kg .36 lb	17244A	61.981 2.4402	14.288 .5625	1.5 .06	.09 kg .20 lb	16.002 .6300	17245D: GROOVE IN OD CENTER HOLES IN OD CENTER	
17118	29.987 1.1806	16.566 .6522	1.5 .06	.14 kg .30 lb	*17244-B	62.000 2.4409	14.288 .5625	1.5 .06	.10 kg .23 lb	5.270 .2075		
17118-S	30.000 1.1811	16.566 .6522	1.5 .06	.14 kg .30 lb	*17245D	62.000 2.4409	36.258 1.4275	.8 .03	.25 kg .55 lb	39.687 1.5625		
17119	30.162 1.1875	16.566 .6522	1.5 .06	.14 kg .30 lb	17245XA	62.000 2.4409	15.977 .6290	1.5 .06	.10 kg .22 lb	17.455 .6872		
17119W	30.162 1.1875	16.566 .6522	1.5 .06	.13 kg .28 lb								
17116D	30.162 1.1875	34.925 1.3750	.8 .03	.37 kg .83 lb	17244	62.000 2.4409	14.288 .5625	1.5 .06	.09 kg .20 lb	33.797 1.3306		
*17117TD	30.140 1.1866	34.925 1.3750	.8 .03	.38 kg .85 lb	17244A	61.981 2.4402	14.288 .5625	1.5 .06	.09 kg .20 lb	33.797 1.3306		
					17245XA	62.000 2.4409	15.977 .6290	1.5 .06	.10 kg .22 lb	36.703 1.4450		
NA17098	24.981 .9835	19.842 .7812	1.5 .06	.36 kg .80 lb	*17245D	62.000 2.4409	36.258 1.4275	.8 .03	.25 kg .55 lb	39.685 1.5624		
<b>JP17000 Series</b>												
†JP17049	170.000 6.6929	30.000 1.1811	3.0 .12	2.51 kg 5.53 lb	*†JP17010-B	230.000 9.0551	23.000 .9055	3.0 .12	1.03 kg 2.28 lb	15.000 .5905	JP17049P: GROOVE IN OD BACKFACE JP17010-B: FLANGE ON OD FRONTFACE, BEARING WIDTH IS T1 DIMENSION	
					†JP17010	230.000 9.0551	23.000 .9055	3.0 .12	.92 kg 2.02 lb	32.000 1.2598		
†JP17049P	SEE HYDRA-RIB BEARING SECTION				†JP17019HR	SEE HYDRA-RIB BEARING SECTION						
<b>17400 Series</b>												
*17481	13.495 .5313	14.288 .5625	1.5 .06	- -	*17420DB	39.688 1.5625	25.400 1.0000	.8 .03	.10 kg .21 lb	31.750 1.2500	17481: NO SMALL RIB 17420DB: FLANGE ON OD RIGHTFACE	
<b>17400 Series</b>												
17481					17420DB	SEE MULTI-ROW STEERING GEAR BEARING SECTION						
17482												
17483					SEE MULTI-ROW STEERING GEAR BEARING SECTION							
17484												
17485												
17486												
<b>17500 Series</b>												
17580	15.875 .6250	16.670 .6563	1.5 .06	.07 kg .16 lb	*17520-B	42.862 1.6875	13.495 .5313	1.5 .06	.05 kg .12 lb	6.350 .2500	17581: BROKEN FRONTFACE ID NO SMALL RIB SPECIAL BACKFACE RADIUS	
					17520	42.862 1.6875	3.495 .5313	1.5 .06	.05 kg .10 lb	16.670 .6563		
*17581	15.875 .6250	15.095 .5943	1.5 .06	- -	17520	42.862 1.6875	13.495 .5313	1.5 .06	.05 kg .10 lb	16.670 .6563		

17500 SERIES CONTINUED ON NEXT PAGE

\*\*These Maximum Fillet Radii will be cleared by the Cone or Cup Radii.  
†Bore or O.D. shown are maximum dimensions. \*See Remarks Column.

4

CONE				Max Shaft Fillet Radii R''	Weight	CUP			Max Hs'ng Fillet Radii r''	Weight	BEAR-ING	Remarks
Number	BORE d	WIDTH B	Number			OUTSIDE DIA D	WIDTH C	WIDTH T				
17500 Series (cont)												
					*17520-B	42.862 1.6875	13.495 .5313	1.5 .06	.05 kg .12 lb	6.350 .2500		17520-B : FLANGE ON OD FRONTFACE, BEARING WIDTH IS T1 DIMENSION
					*17520DB	42.862 1.6875	26.988 1.0625	.8 .03	.11 kg .24 lb	33.338 1.3125		17520DB : FLANGE ON OD RIGHTFACE
17581												
17582												
17583	SEE MULTI-ROW STEERING GEAR BEARING SECTION				17520DB	SEE MULTI-ROW STEERING GEAR BEARING SECTION						
17584												
17800 Series												
*17883	39.688 1.5625	31.354 1.2344	3.8 .15	.46 kg 1.01 lb	17830	79.375 3.1250	15.875 .6250	2.0 .08	.13 kg .29 lb	31.354 1.2344		17883: EXTENDED LARGE RIB SHOULDER ON OD BACKFACE SPECIAL BACKFACE CHAMFER
*17884	44.450 1.7500	33.553 1.3210	.8 .03	.39 kg .86 lb	17831	79.985 3.1490	15.080 .5937	1.3 .05	.13 kg .29 lb	30.559 1.2031		17884: EXTENDED LARGE RIB SHOULDER ON OD BACKFACE
*17888	44.450 1.7500	31.354 1.2344	3.8 .15	.38 kg .84 lb								17888: EXTENDED LARGE RIB SHOULDER ON OD BACKFACE SPECIAL BACKFACE CHAMFER
17886	42.987 1.6924	20.638 .8125	1.5 .06	.30 kg .65 lb	17886 and grouped cones may be paired with all single cups corresponding to 17883 and will require -10.716 mm (-.4219 in) to be added to the T-width values.							
17887	45.230 1.7807	20.638 .8125	2.0 .08	.27 kg .59 lb								
18000 Series												
18200	50.800 2.0000	18.263 .7190	1.5 .06	.27 kg .59 lb	18335X	85.000 3.3465	12.500 .4921	1.5 .06	.12 kg .27 lb	19.050 .7500		18200XX: MADE FROM VACUUM MELT STEEL
*18200XX	50.800 2.0000	18.263 .7190	1.5 .06	.27 kg .59 lb	18335E	85.000 3.3465	18.000 .7087	1.5 .06	.15 kg .32 lb	24.500 .9646		18337-B : FLANGE ON OD FRONTFACE, BEARING WIDTH IS T1 DIMENSION
18204X	52.000 2.0472	18.263 .7190	2.0 .08	.25 kg .55 lb	*18337-B	85.725 3.3750	12.700 .5000	1.5 .06	.15 kg .34 lb	9.906 .3900		18337XX : MADE FROM VACUUM MELT STEEL
					*18337XX	85.725 3.3750	12.700 .5000	1.5 .06	.13 kg .29 lb	19.050 .7500		
					18337	85.725 3.3750	12.700 .5000	1.5 .06	.13 kg .29 lb	19.050 .7500		
					18352	88.900 3.5000	19.050 .7500	1.5 .06	.24 kg .54 lb	20.637 .8125		
JP18000 Series												
†JP18049	180.000 7.0866	30.000 1.1811	3.0 .12	2.61 kg 5.77 lb	*†JP18010-B	240.000 9.4488	23.000 .9055	3.0 .12	1.12 kg 2.47 lb	15.000 .5905		JP18049-S: HOLES IN BACKFACE TO UNDERCUT
*†JP18049-S	180.000 7.0866	30.000 1.1811	3.0 .12	2.61 kg 5.75 lb	†JP18010	240.000 9.4488	23.000 .9055	3.0 .12	.97 kg 2.15 lb	32.000 1.2598		JP18010-B : FLANGE ON OD FRONTFACE, BEARING WIDTH IS T1 DIMENSION
†JP18049P	SEE HYDRA-RIB SECTION				†JP18019HR	SEE HYDRA-RIB SECTION						
18500 Series												
18587	39.688 1.5625	17.462 .6875	.8 .03	.21 kg .47 lb	18520	73.025 2.8750	12.700 .5000	1.5 .06	.08 kg .18 lb	16.667 .6562		
18590	41.275 1.6250	17.462 .6875	3.5 .14	.19 kg .43 lb								
18591	41.275 1.6250	17.462 .6875	1.3 .05	.20 kg .44 lb								
18600 Series												
18685	44.450 1.7500	17.462 .6875	2.8 .11	.22 kg .49 lb	*18620-B	79.375 3.1250	13.495 .5313	1.5 .06	.14 kg .32 lb	7.538 .2968		18620-B : FLANGE ON OD FRONTFACE, BEARING WIDTH IS T1 DIMENSION SPECIAL RADIUS ON BACKFACE OD
18690	46.038 1.8125	17.462 .6875	2.8 .11	.21 kg .46 lb	18620	79.375 3.1250	13.495 .5313	1.5 .06	.12 kg .27 lb	17.462 .6875		
					18620XD	79.375 3.1250	33.338 1.3125	.8 .03	.31 kg .68 lb	41.272 1.6249		18620D : GROOVE IN OD CENTER HOLES IN OD CENTER

\*These Maximum Fillet Radii will be cleared by the Cone or Cup Radii.  
†Bore or O.D. shown are maximum dimensions. \*See Remarks Column.

18600 – 19000 SERIES

4

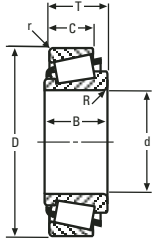

SINGLE ROW

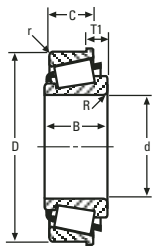

SINGLE ROW WITH FLANGE

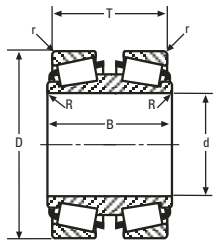

DOUBLE CONE

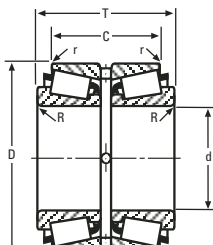

DOUBLE CUP

CONE			Max Shaft Fillet Radii R <sup>**</sup>	Weight	CUP			Max H's'ng Fillet Radii r <sup>**</sup>	Weight	BEARING WIDTH T	Remarks
Number	BORE d	WIDTH B			Number	OUTSIDE DIA D	WIDTH C				
<b>18600 Series (cont)</b>											
NA18685	44.450 1.7500	20.635 .8124	2.8 .11	-	*18620DC	79.375 3.1250	33.338 1.3125	.8 .03	.31 kg .68 lb	41.272 1.6249	18620DC : HOLES IN OD CENTER
					*18620D	79.375 3.1250	33.338 1.3125	.8 .03	.31 kg .68 lb	41.272 1.6249	
					18621XD	79.375 3.1250	74.615 2.9376	.8 .03	.82 kg 1.80 lb	82.549 3.2500	
					18620XD	79.375 3.1250	33.338 1.3125	.8 .03	.31 kg .68 lb	41.270 1.6248	
					*18620DC	79.375 3.1250	33.338 1.3125	.8 .03	.31 kg .68 lb	41.270 1.6248	
					*18620D	79.375 3.1250	33.338 1.3125	.8 .03	.31 kg .68 lb	41.270 1.6248	
					18621XD	79.375 3.1250	74.615 2.9376	.8 .03	.82 kg 1.80 lb	82.549 3.2500	
					18620XD	79.375 3.1250	33.338 1.3125	.8 .03	.31 kg .68 lb	41.270 1.6248	
					*18620DC	79.375 3.1250	33.338 1.3125	.8 .03	.31 kg .68 lb	41.270 1.6248	
					*18620D	79.375 3.1250	33.338 1.3125	.8 .03	.31 kg .68 lb	41.270 1.6248	
<b>18700 Series</b>											
18780	46.038 1.8125	17.462 .6875	2.3 .09	.29 kg .63 lb	*18720-B	85.000 3.3465	13.495 .5313	1.5 .06	.17 kg .37 lb	7.539 2.968	18720-B : FLANGE ON OD FRONTFACE, BEARING WIDTH IS T1 DIMENSION
18790	50.800 2.0000	17.462 .6875	3.5 .14	.23 kg .51 lb	18720	85.000 3.3465	13.495 .5313	1.5 .06	.13 kg .29 lb	17.462 .6875	
					18721	83.312 3.2800	13.495 .5313	.8 .03	.11 kg .25 lb	17.462 .6875	
					18723	88.900 3.5000	16.670 .6563	1.3 .05	.25 kg .55 lb	20.637 .8125	
					18724	88.900 3.5000	13.495 .5313	1.3 .05	.19 kg .42 lb	17.462 .6875	
<b>19000 Series</b>											
*19137DA	34.925 1.3750	64.295 2.5313	.8 .03	.57 kg 1.25 lb	19262	66.675 2.6250	11.908 4.688	.8 .03	.06 kg .13 lb	31.750 1.2500	19137DA: ASYMMETRICAL BEARING HOLES IN OD LEFTFACE
*19137DAA	34.925 1.3750	64.295 2.5313	.8 .03	.57 kg 1.25 lb	19267X	68.000 2.6772	12.000 4.724	1.5 .06	.07 kg .16 lb	32.040 1.2614	19137DAA: ASYMMETRICAL BEARING HOLES IN OD LEFTFACE
*19137DE	34.925 1.3750	76.200 3.0000	.8 .03	.60 kg 1.33 lb	19268	68.262 2.6875	11.908 4.688	1.5 .06	.07 kg .16 lb	31.750 1.2500	19137DE: EXTENDED SMALL RIB
*19137DEE	34.925 1.3750	76.200 3.0000	.8 .03	.60 kg 1.33 lb	19268X	68.275 2.6880	16.032 .6312	1.5 .06	.11 kg .25 lb	40.000 1.5748	19137DEE: EXTENDED SMALL RIB
*19138DE	35.000 1.3780	76.200 3.0000	.8 .03	.66 kg 1.45 lb	19269	68.262 2.6875	16.030 .6311	1.5 .06	.11 kg .24 lb	39.995 1.5746	19138DE: EXTENDED SMALL RIB
*19138DEE	35.000 1.3780	76.200 3.0000	.8 .03	.66 kg 1.45 lb	19281	71.438 2.8125	11.908 4.688	1.0 .04	.11 kg .23 lb	31.750 1.2500	19138DEE: EXTENDED SMALL RIB
*19143DA	36.512 1.4375	64.295 2.5313	.8 .03	.53 kg 1.16 lb	19282	71.438 2.8125	15.875 6.250	1.5 .06	.14 kg .30 lb	34.925 1.3750	19143DA: ASYMMETRICAL BEARING HOLES IN OD LEFTFACE
*19143DAA	36.512 1.4375	64.295 2.5313	.8 .03	.53 kg 1.16 lb	19283	72.000 2.8346	14.288 5.625	1.5 .06	.13 kg .29 lb	34.036 1.3400	19143DAA: ASYMMETRICAL BEARING HOLES IN OD LEFTFACE
*19143DE	36.512 1.4375	76.200 3.0000	.8 .03	.55 kg 1.22 lb	19283X	72.000 2.8346	14.288 5.625	2.0 .08	.13 kg .29 lb	34.036 1.3400	19143DAA: ASYMMETRICAL BEARING HOLES IN OD LEFTFACE
*19143DEE	36.512 1.4375	76.200 3.0000	.8 .03	.55 kg 1.22 lb							19143DE: EXTENDED SMALL RIB
19138	34.976 1.3770	16.520 .6504	1.5 .06	.19 kg .41 lb	19262	66.675 2.6250	11.908 4.688	.8 .03	.06 kg .13 lb	15.875 .6250	19143DEE: EXTENDED SMALL RIB
19138A	4.976 1.3770	16.520 .6504	1.5 .06	.19 kg .41 lb	19267X	68.000 2.6772	12.000 4.724	1.5 .06	.07 kg .16 lb	16.020 .6307	19146TD: ASYMMETRICAL BEARING TAPERED BORE
19138X	35.000 1.3780	16.520 .6504	2.0 .08	.19 kg .41 lb	19268	68.262 2.6875	11.908 4.688	1.5 .06	.07 kg .16 lb	15.875 .6250	19268-B : FLANGE ON OD FRONTFACE, BEARING WIDTH IS T1 DIMENSION
19143	36.512 1.4375	16.520 .6504	1.5 .06	.18 kg .39 lb	*19268-B	68.262 2.6875	11.908 4.688	1.5 .06	.09 kg .19 lb	7.539 2.968	19283-B : FLANGE ON OD FRONTFACE, BEARING WIDTH IS T1 DIMENSION
19149X	38.000 1.4961	16.520 .6504	2.0 .08	.16 kg .36 lb	19268X	68.275 2.6880	16.032 .6312	1.5 .06	.11 kg .25 lb	20.000 .7874	19143DE: EXTENDED SMALL RIB
19150	38.100 1.5000	16.520 .6504	1.5 .06	.17 kg .37 lb	19269	68.262 2.6875	16.030 .6311	1.5 .06	.11 kg .24 lb	19.997 .7873	19143DE: EXTENDED SMALL RIB
19153X	38.496 1.5156	16.520 .6504	1.3 .05	.16 kg .36 lb	19281	71.438 2.8125	11.908 4.688	1.0 .04	.11 kg .23 lb	15.875 .6250	19143DE: EXTENDED SMALL RIB
					19282	71.438 2.8125	15.875 6.250	1.5 .06	.14 kg .30 lb	17.462 .6875	19143DE: EXTENDED SMALL RIB
					19283	72.000 2.8346	14.288 5.625	1.5 .06	.13 kg .29 lb	17.018 .6700	19143DE: EXTENDED SMALL RIB

19000 SERIES CONTINUED ON NEXT PAGE

\*\*These Maximum Fillet Radii will be cleared by the Cone or Cup Radii.  
†Bore or O.D. shown are maximum dimensions. \*See Remarks Column.

4

CONE				Weight	CUP			Max Hs'ng Fillet Radii r''	Weight	BEARING WIDTH T	Remarks
Number	BORE d	WIDTH B	Max Shaft Fillet Radii R''		Number	OUTSIDE DIA D	WIDTH C				
<b>19000 Series (cont)</b>											
					<b>*19283-B</b>	<b>72.000</b> 2.8346	<b>14.288</b> .5625	<b>1.5</b> .06	<b>.14 kg</b> .32 lb	<b>6.286</b> .2475	
					<b>19283X</b>	<b>72.000</b> 2.8346	<b>14.288</b> .5625	<b>2.0</b> .08	<b>.13 kg</b> .29 lb	<b>17.018</b> .6700	
<b>19144DW</b>	<b>36.512</b> 1.4375	<b>49.200</b> 1.9370	<b>.8</b> .03	<b>.49 kg</b> 1.07 lb	19144DW and grouped cones may be paired with all single cups corresponding to 19137DA and will require 5.060 mm (.1992 in) to be added to the T-width values.						
<b>19145D</b>	<b>36.512</b> 1.4375	<b>38.100</b> 1.5000	<b>.8</b> .03	<b>.46 kg</b> 1.02 lb							
<b>*19146TD</b>	<b>37.036</b> 1.4581	<b>38.100</b> 1.5000	<b>.8</b> .03	<b>.46 kg</b> 1.02 lb							
<b>19152D</b>	<b>38.100</b> 1.5000	<b>49.200</b> 1.9370	<b>.8</b> .03	<b>.45 kg</b> .99 lb							
<b>JP20000 Series</b>											
<b>*†JP20049P</b>	SEE HYDRA-RIB BEARINGSECTION				<b>†JP20019HR</b>	SEE HYDRA-RIB BEARING SECTION					
<b>LL20900 Series</b>											
<b>*LL20949NW</b>	<b>7.938</b> .3125	<b>11.176</b> .4375	<b>.8</b> .03	<b>.04 kg</b> .08 lb	<b>K103254</b>	<b>28.575</b> 1.1250	<b>21.463</b> .8450	<b>1.3</b> .05	<b>.05 kg</b> .11 lb	<b>22.225</b> .8750	LL20949NW: FRONTFACE CHAMFER SLOTS IN FRONTFACE
					<b>*K444657</b>	<b>34.925</b> 1.3750	<b>21.463</b> .8450	<b>.8</b> .03	<b>.08 kg</b> .18 lb	<b>22.225</b> .8750	K444657: SPHERICAL OD
<b>21000 Series</b>											
<b>21063</b>	<b>15.875</b> .6250	<b>21.839</b> .8598	<b>.8</b> .03	<b>.17 kg</b> .37 lb	<b>*21212-B</b>	<b>53.975</b> 2.1250	<b>15.875</b> .6250	<b>2.3</b> .09	<b>.11 kg</b> .24 lb	<b>10.318</b> .4062	21212-B : FLANGE ON OD FRONTFACE, BEARING WIDTH IS T1 DIMENSION
<b>21075</b>	<b>19.050</b> .7500	<b>21.839</b> .8598	<b>1.5</b> .06	<b>.15 kg</b> .34 lb	<b>21212</b>	<b>53.975</b> 2.1250	<b>15.875</b> .6250	<b>2.3</b> .09	<b>.09 kg</b> .21 lb	<b>22.225</b> .8750	21226D : GROOVE IN OD CENTER HOLES IN OD CENTER
<b>21075A</b>	<b>19.050</b> .7500	<b>21.839</b> .8598	<b>1.5</b> .06	<b>.15 kg</b> .34 lb	<b>21213</b>	<b>53.975</b> 2.1250	<b>15.875</b> .6250	<b>.5</b> .02	<b>.10 kg</b> .22 lb	<b>22.225</b> .8750	
<b>21075X</b>	<b>19.050</b> .7500	<b>21.839</b> .8598	<b>1.5</b> .06	<b>.16 kg</b> .34 lb	<b>*21226D</b>	<b>57.150</b> 2.2500	<b>36.512</b> 1.4375	<b>.8</b> .03	<b>.31 kg</b> .68 lb	<b>49.213</b> 1.9375	
<b>NA21075</b>	<b>19.050</b> .7500	<b>24.608</b> .9688	<b>1.5</b> .06	<b>-</b> -	<b>*21226D</b>	<b>57.150</b> 2.2500	<b>36.512</b> 1.4375	<b>.8</b> .03	<b>.31 kg</b> .68 lb	<b>49.215</b> 1.9376	
<b>L21500 Series</b>											
<b>L21549</b>	<b>15.875</b> .6250	<b>10.998</b> .4330	<b>1.3</b> .05	<b>.03 kg</b> .07 lb	<b>L21511</b>	<b>34.989</b> 1.3775	<b>8.712</b> .3430	<b>1.3</b> .05	<b>.02 kg</b> .04 lb	<b>10.998</b> .4330	
<b>22000 Series</b>											
<b>*22150DA</b>	<b>38.100</b> 1.5000	<b>72.233</b> 2.8438	<b>.8</b> .03	<b>1.06 kg</b> 2.33 lb	<b>22325</b>	<b>82.550</b> 3.2500	<b>15.080</b> .5937	<b>1.5</b> .06	<b>.18 kg</b> .39 lb	<b>38.110</b> 1.5004	22150DA: ASYMMETRICAL BEARING HOLES IN OD LEFTFACE
<b>*22150DAA</b>	<b>38.100</b> 1.5000	<b>72.233</b> 2.8438	<b>.8</b> .03	<b>1.06 kg</b> 2.33 lb							22150DAA: ASYMMETRICAL BEARING HOLES IN OD LEFTFACE
<b>*22150DE</b>	<b>38.100</b> 1.5000	<b>85.725</b> 3.3750	<b>.8</b> .03	<b>1.14 kg</b> 2.52 lb							22150DE: EXTENDED SMALL RIB
<b>*22150DEE</b>	<b>38.100</b> 1.5000	<b>85.725</b> 3.3750	<b>.8</b> .03	<b>1.14 kg</b> 2.52 lb							22150DEE: EXTENDED SMALL RIB
<b>*22157DE</b>	<b>40.000</b> 1.5748	<b>85.725</b> 3.3750	<b>.8</b> .03	<b>1.08 kg</b> 2.37 lb							22157DE: EXTENDED SMALL RIB
<b>*22157DEE</b>	<b>40.000</b> 1.5748	<b>85.725</b> 3.3750	<b>.8</b> .03	<b>-</b> -							22157DEE: EXTENDED SMALL RIB
<b>*22162DA</b>	<b>41.275</b> 1.6250	<b>72.233</b> 2.8438	<b>.8</b> .03	<b>.94 kg</b> 2.08 lb							22162DA: ASYMMETRICAL BEARING HOLES IN OD LEFTFACE
<b>*22162DAA</b>	<b>41.275</b> 1.6250	<b>72.233</b> 2.8438	<b>.8</b> .03	<b>.94 kg</b> 2.08 lb							22162DAA: ASYMMETRICAL BEARING HOLES IN OD LEFTFACE
<b>*22162DE</b>	<b>41.275</b> 1.6250	<b>85.725</b> 3.3750	<b>.8</b> .03	<b>1.01 kg</b> 2.23 lb							22162DAA: ASYMMETRICAL BEARING HOLES IN OD LEFTFACE
<b>*22162DEE</b>	<b>41.275</b> 1.6250	<b>85.725</b> 3.3750	<b>.8</b> .03	<b>1.01 kg</b> 2.23 lb							22162DE: EXTENDED SMALL RIB
<b>*22168DA</b>	<b>42.862</b> 1.6875	<b>72.233</b> 2.8438	<b>.8</b> .03	<b>.88 kg</b> 1.95 lb							22162DEE: EXTENDED SMALL RIB
<b>*22168DAA</b>	<b>42.862</b> 1.6875	<b>72.233</b> 2.8438	<b>.8</b> .03	<b>.88 kg</b> 1.95 lb							22168DA: ASYMMETRICAL BEARING HOLES IN OD LEFTFACE
<b>*22168DE</b>	<b>42.862</b> 1.6875	<b>85.725</b> 3.3750	<b>.8</b> .03	<b>.94 kg</b> 2.08 lb							22168DA: ASYMMETRICAL BEARING HOLES IN OD LEFTFACE
<b>*22168DEE</b>	<b>42.862</b> 1.6875	<b>85.725</b> 3.3750	<b>.8</b> .03	<b>.94 kg</b> 2.08 lb							22168DAA: ASYMMETRICAL BEARING HOLES IN OD LEFTFACE

†These Maximum Fillet Radii will be cleared by the Cone or Cup Radii.  
†Bore or O.D. shown are maximum dimensions. \*See Remarks Column.

22000 – 24700 SERIES

4

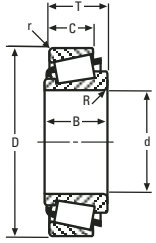

SINGLE ROW

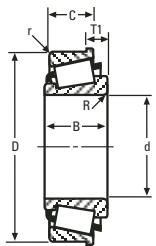

SINGLE ROW WITH FLANGE

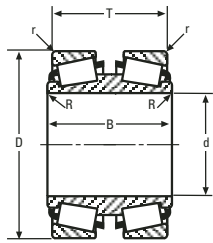

DOUBLE CONE

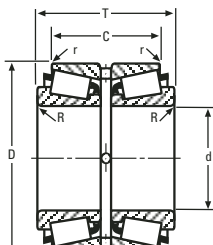

DOUBLE CUP

CONE			Max Shaft Fillet Radii R <sup>**</sup>	Weight	CUP			Max Hs'ng Fillet Radii r <sup>**</sup>	Weight	BEARING WIDTH T	Remarks
Number	BORE d	WIDTH B			Number	OUTSIDE DIA D	WIDTH C				
<b>22000 Series (cont)</b>											
22168	42.862 1.6875	19.837 .7810	2.3 .09	.27 kg .59 lb	22325	82.550 3.2500	15.080 .5937	1.5 .06	.18 kg .39 lb	19.842 .7812	22168DE: EXTENDED SMALL RIB
					*22325D	82.550 3.2500	34.925 1.3750	.8 .03	.46 kg 1.01 lb	44.450 1.7500	22168DEE: EXTENDED SMALL RIB
											22325D : GROOVE IN OD CENTER HOLES IN OD CENTER
NA22171	43.658 1.7188	22.225 .8750	2.3 .09	- -	*22325D	82.550 3.2500	34.925 1.3750	.8 .03	.46 kg 1.01 lb	44.450 1.7500	
<b>JP22000 Series</b>											
*†JP22049E	SEE HYDRA-RIB BEARING SECTION				*†JP22019HR	SEE HYDRA-RIB BEARING SECTION					
<b>L22300 Series</b>											
*†JL22349	22.000 .8661	14.400 .5669	.8 .03	.05 kg .11 lb	†JL22310	41.000 1.6142	11.400 .4488	.8 .03	.03 kg .07 lb	14.400 .5669	JL22349: FRONTFACE CHAMFER
*†JL22349F	22.000 .8661	14.400 .5669	.8 .03	- -							JL22349F: FRONTFACE CHAMFER
<b>22700 Series</b>											
22778	41.275 1.6250	26.988 1.0625	3.5 .14	.43 kg .94 lb	22720	82.550 3.2500	20.638 .8125	3.3 .13	.22 kg .48 lb	26.195 1.0313	
22780	42.862 1.6875	26.988 1.0625	3.5 .14	.40 kg .89 lb	22721	82.550 3.2500	20.638 .8125	.8 .03	.23 kg .50 lb	26.195 1.0313	
<b>23000 Series</b>											
23092	23.812 .9375	21.463 .8450	1.5 .06	.23 kg .51 lb	23250X	63.500 2.5000	14.681 .5780	2.3 .09	.11 kg .24 lb	21.691 .8540	23256-B : FLANGE ON OD FRONTFACE, BEARING WIDTH IS T1 DIMENSION
23098-S	25.000 .9843	21.463 .8450	2.0 .08	.22 kg .49 lb	23255X	65.000 2.5591	15.875 .6250	2.0 .08	.14 kg .30 lb	22.225 .8750	
23100	25.400 1.0000	21.463 .8450	1.5 .06	.22 kg .49 lb	*23256-B	65.088 2.5625	15.875 .6250	1.5 .06	.16 kg .35 lb	10.320 .4063	
					23256	65.088 2.5625	15.875 .6250	1.5 .06	.14 kg .31 lb	22.225 .8750	
23101X	25.400 1.0000	20.650 .8130	2.3 .09	.21 kg .46 lb	23101X may be paired with all single cups corresponding to 23092 and will require -.1054 mm (-.0415 in) to be added to the T-width values.						
<b>23400 Series</b>											
23491	31.750 1.2500	26.988 1.0625	1.5 .06	.32 kg .71 lb	23420	68.262 2.6875	22.225 .8750	1.5 .06	.17 kg .37 lb	26.987 1.0625	
<b>23600 Series</b>											
*23685	31.750 1.2500	26.975 1.0620	3.5 .14	.34 kg .75 lb	23620	73.025 2.8750	22.225 .8750	1.5 .06	.21 kg .47 lb	26.988 1.0625	23685: BROKEN FRONTFACE ID
*23690	34.925 1.3750	26.975 1.0620	3.5 .14	.31 kg .67 lb	23621	73.025 2.8750	22.225 .8750	.8 .03	.21 kg .47 lb	26.988 1.0625	23690: BROKEN FRONTFACE ID
*23691	35.000 1.3780	26.975 1.0620	3.5 .14	.31 kg .67 lb							23691: BROKEN FRONTFACE ID
<b>23700 Series</b>											
23790	34.925 1.3750	26.988 1.0625	3.5 .14	.32 kg .70 lb	23720	73.025 2.8750	22.225 .8750	1.5 .06	.20 kg .44 lb	26.988 1.0625	
<b>24000 Series</b>											
24112	28.575 1.1250	18.974 .7470	1.5 .06	.19 kg .42 lb	24261	66.421 2.6150	15.875 .6250	1.5 .06	.12 kg .27 lb	19.052 .7501	24262D : GROOVE IN OD CENTER HOLES IN OD CENTER
24118	30.162 1.1875	18.974 .7470	1.5 .06	.18 kg .40 lb	*24262D	66.421 2.6150	38.100 1.5000	.8 .03	.31 kg .69 lb	44.453 1.7501	
<b>JP24000 Series</b>											
*†JP24049	240.000 9.4488	39.000 1.5354	3.0 .12	6.09 kg 13.44 lb	†JP24010	320.000 12.5984	30.000 1.1811	3.0 .12	2.15 kg 4.74 lb	42.000 1.6535	JP24049: FRONTFACE CHAMFER
<b>24700 Series</b>											
*NA24775-SW	38.100 1.5000	29.367 1.1562	spcl. spcl.	.74 kg 1.64 lb	*24720D	76.200 3.0000	39.688 1.5625	.8 .03	.37 kg .83 lb	58.735 2.3124	NA24775-SW: BACKFACE CHAMFER EXTENDED LARGE RIB FRONTFACE CHAMFER SLOTS IN FRONTFACE
*NA24776-SW	38.100 1.5000	29.367 1.1562	.8 .03	.78 kg 1.73 lb	*24720DC	76.200 3.0000	39.688 1.5625	.8 .03	.37 kg .83 lb	58.735 2.3124	
					24720XD	76.200 3.0000	39.688 1.5625	.8 .03	.36 kg .79 lb	58.735 2.3124	NA24776-SW: EXTENDED LARGE RIB FRONTFACE CHAMFER SLOTS IN FRONTFACE
					*T70124	101.600 4.0000	57.150 2.2500	6.0 .24	1.73 kg 3.81 lb	58.735 2.3124	

24700 SERIES CONTINUED ON NEXT PAGE

\*\*These Maximum Fillet Radii will be cleared by the Cone or Cup Radii.  
†Bore or O.D. shown are maximum dimensions. \*See Remarks Column.

4

CONE			Max Shaft Fillet Radii R''	Weight	CUP			Max Hs'ng Fillet Radii r''	Weight	BEARING	Remarks
Number	BORE d	WIDTH B			Number	OUTSIDE DIA D	WIDTH C			T	
<b>24700 Series (cont)</b>											
					K78175	107.950 4.2500	57.150 2.2500	3.3 .13	2.20 kg 4.84 lb	58.735 2.3124	24780: BROKEN FRONTFACE ID
					K97753	101.600 4.0000	57.150 2.2500	3.3 .13	1.73 kg 3.81 lb	58.735 2.3124	24781: BROKEN FRONTFACE ID
					*K104606	101.600 4.0000	57.150 2.2500	3.2 .12	2.28 kg 5.03 lb	58.735 2.3124	24720-B : FLANGE ON OD FRONTFACE, BEARING WIDTH IS T1 DIMENSION
					*K107100	101.600 4.0000	57.150 2.2500	1.5 .06	1.71 kg 3.77 lb	58.735 2.3124	24720D : GROOVE IN OD CENTER HOLES IN OD CENTER
					*K302672	115.692 4.5548	57.150 2.2500	- -	2.05 kg 4.53 lb	58.735 2.3124	24720DC : HOLES IN OD CENTER
					K444666	101.600 4.0000	57.150 2.2500	3.3 .13	1.73 kg 3.81 lb	58.735 2.3124	T70124 : SPECIAL RADIUS ON LEFTFACE OD SPECIAL RADIUS ON RIGHTFACE OD
*24780	41.275 1.6250	23.020 .9063	3.5 .14	.28 kg .61 lb	24720	76.200 3.0000	17.462 .6875	.8 .03	.15 kg .33 lb	22.225 .8750	K104606 : FLANGE ON OD LEFTFACE
*24781	41.275 1.6250	23.020 .9063	.8 .03	.28 kg .62 lb	*24720-B	76.200 3.0000	17.462 .6875	.8 .03	.17 kg .38 lb	9.525 .3750	K107100 : SPHERICAL OD
					*24720D	76.200 3.0000	39.688 1.5625	.8 .03	.37 kg .83 lb	49.212 1.9375	K302672 : TAPERED OD
					*24720DC	76.200 3.0000	39.688 1.5625	.8 .03	.37 kg .83 lb	49.212 1.9375	
					24720XD	76.200 3.0000	39.688 1.5625	.8 .03	.36 kg .79 lb	49.212 1.9375	
					24721	76.200 3.0000	20.638 .8125	2.3 .09	.19 kg .41 lb	25.400 1.0000	
					24722	76.200 3.0000	17.462 .6875	3.3 .13	.14 kg .31 lb	22.225 .8750	
					*T70124	101.600 4.0000	57.150 2.2500	6.0 .24	1.73 kg 3.81 lb	49.439 1.9464	
<b>25000 Series</b>											
25132	33.338 1.3125	18.923 .7450	2.3 .09	.46 kg 1.02 lb	*25289D	73.025 2.8750	35.522 1.3985	.8 .03	.38 kg .85 lb	42.863 1.6875	25289D : GROOVE IN OD CENTER HOLES IN OD CENTER
<b>25500 Series</b>											
25570	36.512 1.4375	25.400 1.0000	3.5 .14	.45 kg 1.00 lb	25518	81.973 3.2273	19.114 .7525	1.0 .04	.18 kg .40 lb	23.876 .9400	25580A: SPECIAL BACKFACE RADIUS
25572	38.100 1.5000	25.400 1.0000	.8 .03	.44 kg .97 lb	25519	82.550 3.2500	19.050 .7500	2.0 .08	.19 kg .42 lb	23.813 .9375	25583: EXTENDED LARGE RIB
25576	42.862 1.6875	25.400 1.0000	3.5 .14	.37 kg .82 lb	25520	82.931 3.2650	19.050 .7500	.8 .03	.20 kg .44 lb	23.813 .9375	25584T: BROKEN FRONTFACE ID SPECIAL BACKFACE RADIUS TAPERED BORE
25577	42.875 1.6880	25.400 1.0000	3.5 .14	.37 kg .82 lb	*25520D	82.931 3.2650	47.625 1.8750	.8 .03	.57 kg 1.26 lb	57.150 2.2500	25520D: GROOVE IN OD CENTER HOLES IN OD CENTER
25577C	42.875 1.6880	25.400 1.0000	3.5 .14	.38 kg .84 lb	*25520DC	82.931 3.2650	47.625 1.8750	.8 .03	.57 kg 1.26 lb	57.150 2.2500	
25578	42.862 1.6875	25.400 1.0000	2.3 .09	.38 kg .83 lb	25521	83.058 3.2700	19.050 .7500	3.3 .13	.19 kg .43 lb	23.813 .9375	25520DC: HOLES IN OD CENTER
25580	44.450 1.7500	25.400 1.0000	3.5 .14	.35 kg .77 lb	*25521-B	83.058 3.2700	19.050 .7500	spcl. spcl.	.22 kg .49 lb	8.733 .3438	25521-B: FLANGE ON OD FRONTFACE, BEARING WIDTH IS T1 DIMENSION
*25580A	44.450 1.7500	25.400 1.0000	spcl. spcl.	.36 kg .79 lb	25522	83.058 3.2700	19.114 .7525	2.0 .08	.20 kg .44 lb	23.876 .9400	SPECIAL RADIUS ON BACKFACE OD
25581	44.450 1.7500	25.400 1.0000	.5 .02	.36 kg .79 lb	25523	82.931 3.2650	22.225 .8750	2.3 .09	.24 kg .54 lb	26.988 1.0625	25530RB: GROOVE IN OD FRONTFACE
25582	44.450 1.7500	25.400 1.0000	5.0 .20	.34 kg .76 lb	25524	82.931 3.2650	19.050 .7500	2.3 .09	.20 kg .43 lb	23.813 .9375	CN25540: SPECIAL RADIUS ON BACKFACE OD
25584	44.983 1.7710	25.400 1.0000	1.5 .06	.35 kg .77 lb	25526	85.000 3.3465	19.050 .7500	2.3 .09	.24 kg .52 lb	23.813 .9375	25547RB: GROOVE IN OD FRONTFACE
25584A	44.988 1.7712	25.400 1.0000	3.5 .14	.34 kg .76 lb	25527	85.000 3.3465	22.225 .8750	2.3 .09	.29 kg .64 lb	26.988 1.0625	
*25584T	44.978 1.7708	25.400 1.0000	spcl. spcl.	.35 kg .77 lb	25528	92.075 3.6250	19.050 .7500	.8 .03	.39 kg .86 lb	23.813 .9375	
25590	45.618 1.7960	25.400 1.0000	3.5 .14	.33 kg .74 lb	*25530RB	84.138 3.3125	19.050 .7500	.8 .03	.22 kg .48 lb	23.813 .9375	
25592	46.038 1.8125	25.400 1.0000	3.5 .14	.33 kg .72 lb	*CN25540	90.488 3.5625	20.638 .8125	spcl. spcl.	.20 kg .45 lb	24.606 .9688	

\*These Maximum Fillet Radii will be cleared by the Cone or Cup Radii.  
†Bore or O.D. shown are maximum dimensions. \*See Remarks Column.

25500 – 26800 SERIES

4

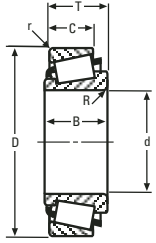

SINGLE ROW



SINGLE ROW WITH FLANGE

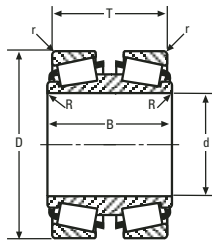

DOUBLE CONE

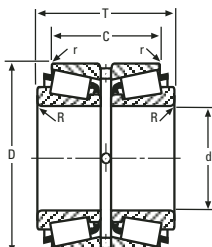

DOUBLE CUP

CONE			Max Shaft Fillet Radii R <sup>**</sup>	Weight	CUP			Max Hs'ng Fillet Radii r <sup>**</sup>	Weight	BEAR-ING	Remarks
Number	BORE d	WIDTH B			Number	OUTSIDE DIA D	WIDTH C			WIDTH T	
25500 Series (cont)					*25547RB	99.995 3.9368	20.638 .8125	.5 .02	.68 kg 1.50 lb	25.400 1.0000	
*25583	44.450 1.7500	35.878 1.4125	3.8 .15	.47 kg 1.04 lb	25583 may be paired with all single cups corresponding to 25570 and will require 10.478 mm (.4125 in) to be added to the T-width values. 25583 may be paired with all double cups corresponding to 25570 and will require 20.955 mm (.8250 in) to be added to the T-width values.						
25800 Series											25877T: TAPERED BORE
25877	34.925 1.3750	24.608 .9688	1.5 .06	-	25820	73.025 2.8750	19.050 .7500	2.3 .09	.16 kg .36 lb	23.813 .9375	
25877A	34.925 1.3750	24.608 .9688	.8 .03	-	25821	73.025 2.8750	19.050 .7500	.8 .03	.17 kg .36 lb	23.813 .9375	
*25877T	34.925 1.3750	24.608 .9688	1.5 .06	-							
25878	34.925 1.3750	24.608 .9688	3.5 .14	-							
25880	36.487 1.4365	24.608 .9688	1.5 .06	-							
26000 Series											
26093	23.812 .9375	18.923 .7450	2.3 .09	.26 kg .57 lb	26274	69.723 2.7450	19.050 .7500	1.5 .06	.14 kg .32 lb	19.050 .7500	NA26118-SW: FRONTFACE CHAMFER SLOTS IN FRONTFACE
26100	25.400 1.0000	18.923 .7450	1.5 .06	.25 kg .56 lb	*26282D	71.438 2.8125	36.512 1.4375	.4 .02	.36 kg .79 lb	42.863 1.6875	26282D: GROOVE IN OD CENTER HOLES IN OD CENTER
26112	28.575 1.1250	18.923 .7450	1.5 .06	.23 kg .51 lb	26283	72.000 2.8346	15.875 .6250	1.5 .06	.16 kg .35 lb	19.000 .7480	26283-B: FLANGE ON OD FRONTFACE, BEARING WIDTH IS T1 DIMENSION
26118	29.987 1.1806	18.923 .7450	1.5 .06	.22 kg .49 lb	*26283-B	72.000 2.8346	15.875 .6250	1.5 .06	.17 kg .38 lb	7.087 .2790	26284D: GROOVE IN OD CENTER HOLES IN OD CENTER
26118-S	30.000 1.1811	18.923 .7450	1.5 .06	.22 kg .49 lb	26283-S	72.000 2.8346	15.875 .6250	2.0 .08	.16 kg .35 lb	19.000 .7480	
26126	32.004 1.2600	18.923 .7450	1.5 .06	.21 kg .46 lb	*26284D	71.973 2.8336	36.512 1.4375	.8 .03	.38 kg .83 lb	42.761 1.6835	
26126X	32.000 1.2598	18.923 .7450	2.0 .08	.21 kg .46 lb	26300	76.200 3.0000	15.875 .6250	1.5 .06	.22 kg .49 lb	19.000 .7480	
26131	33.338 1.3125	18.923 .7450	3.5 .14	.19 kg .43 lb	26334	85.000 3.3465	15.875 .6250	1.6 .06	.36 kg .79 lb	19.000 .7480	
26131H	33.338 1.3125	18.923 .7450	3.5 .14	.20 kg .44 lb							
26132	33.338 1.3125	18.923 .7450	1.5 .06	.20 kg .44 lb							
NA26118	29.987 1.1806	21.382 .8418	1.5 .06	.47 kg 1.04 lb	*26282D	71.438 2.8125	36.512 1.4375	.4 .02	.36 kg .79 lb	42.763 1.6836	
*NA26118-SW	29.987 1.1806	21.382 .8418	1.5 .06	.46 kg 1.02 lb	*26284D	71.973 2.8336	36.512 1.4375	.8 .03	.38 kg .83 lb	42.763 1.6836	
L26700 Series											JL26749F: SPECIAL BACKFACE RADIUS
*†JL26749F	32.000 1.2598	15.000 .5906	spcl. spcl.	.08 kg .17 lb	†JL26710	53.000 2.0866	11.500 .4528	1.3 .05	.04 kg .09 lb	14.500 .5709	
26800 Series											26882T: TAPERED BORE
26877	36.512 1.4375	25.400 1.0000	.8 .03	.41 kg .90 lb	26820	80.167 3.1562	20.638 .8125	3.3 .13	.21 kg .47 lb	25.400 1.0000	
26878	38.100 1.5000	25.400 1.0000	.8 .03	.39 kg .86 lb	26821	80.167 3.1562	24.608 .9688	3.3 .13	.27 kg .60 lb	29.370 1.1563	26822-B: FLANGE ON OD FRONTFACE, BEARING WIDTH IS T1 DIMENSION
26880	39.688 1.5625	25.400 1.0000	1.5 .06	.37 kg .81 lb	26822	79.375 3.1250	19.050 .7500	.8 .03	.18 kg .41 lb	23.813 .9375	
26881	39.688 1.5625	25.400 1.0000	3.5 .14	.36 kg .80 lb	26822A	79.375 3.1250	19.050 .7500	2.3 .09	.18 kg .40 lb	23.813 .9375	
26882	41.275 1.6250	25.400 1.0000	3.5 .14	.34 kg .76 lb	*26822-B	79.375 3.1250	19.050 .7500	.8 .03	.21 kg .46 lb	8.733 .3438	
*26882T	41.275 1.6250	25.400 1.0000	1.5 .06	.35 kg .78 lb	26823	76.200 3.0000	20.638 .8125	1.5 .06	.14 kg .31 lb	25.400 1.0000	
26883	35.000 1.3780	25.400 1.0000	.8 .03	.42 kg .93 lb	26824	80.000 3.1496	19.050 .7500	1.3 .05	.20 kg .43 lb	23.813 .9375	
26884	42.875 1.6880	25.400 1.0000	3.5 .14	.32 kg .71 lb	26830	80.167 3.1562	20.638 .8125	.8 .03	.22 kg .49 lb	25.400 1.0000	
26885	41.275 1.6250	25.400 1.0000	.8 .03	.35 kg .77 lb	26831	88.500 3.4843	20.638 .8125	.8 .03	.40 kg .88 lb	25.400 1.0000	

26800 SERIES CONTINUED ON NEXT PAGE

\*\*These Maximum Fillet Radii will be cleared by the Cone or Cup Radii.  
†Bore or O.D. shown are maximum dimensions. \*See Remarks Column.



4

CONE			Max Shaft Fillet Radii R''	Weight	CUP			Max Hs'ng Fillet Radii r''	Weight	BEARING	Remarks	
Number	BORE d	WIDTH B			Number	OUTSIDE DIA D	WIDTH C			WIDTH T		
26800 Series (cont)												
26886	42.875 1.6880	25.400 1.0000	1.5 .06	.33 kg .72 lb								
27600 Series												
27680	73.025 2.8750	25.400 1.0000	3.5 .14	.93 kg 2.05 lb	27620	125.412 4.9375	19.845 .7813	1.5 .06	.34 kg .76 lb	25.400 1.0000	NA27686T: REVERSE TAPERED BORE  27688H: MADE FROM SPECIAL STEEL	
27684	76.200 3.0000	25.400 1.0000	3.5 .14	.86 kg 1.89 lb	*27620-B	125.412 4.9375	19.845 .7813	1.5 .06	.38 kg .85 lb	10.317 .4062	NA27691T: TAPERED BORE	
27684A	76.200 3.0000	25.400 1.0000	.8 .03	.87 kg 1.91 lb	*27620DA	125.412 4.9375	44.450 1.7500	.8 .03	.89 kg 1.96 lb	55.560 2.1874	27620-B: FLANGE ON OD FRONTFACE, BEARING WIDTH IS T1 DIMENSION	
27687	82.550 3.2500	25.400 1.0000	3.5 .14	.70 kg 1.54 lb	*27620RB	125.412 4.9375	19.845 .7813	1.5 .06	.33 kg .72 lb	25.400 1.0000	27620DA: HOLES IN OD CENTER	
*27688H	83.345 3.2813	25.400 1.0000	.8 .03	- -	27621	125.412 4.9375	25.400 1.0000	3.3 .13	.43 kg .95 lb	28.575 1.1250	27620RB: GROOVE IN OD FRONTFACE	
27689	83.345 3.2813	25.400 1.0000	.8 .03	.69 kg 1.52 lb	*27626DA	136.525 5.3750	44.450 1.7500	.8 .03	1.60 kg 3.52 lb	55.560 2.1874	27626DA: HOLES IN OD CENTER SPHERICAL OD	
27689H	83.345 3.2813	25.400 1.0000	.8 .03	- -								
27690	83.345 3.2813	25.400 1.0000	3.5 .14	.68 kg 1.49 lb								
27691	83.345 3.2813	25.400 1.0000	6.4 .25	.65 kg 1.42 lb								
27695	84.976 3.3455	25.400 1.0000	5.0 .20	.62 kg 1.37 lb								
*NA27686T	82.408 3.2444	27.780 1.0937	3.7 .14	1.53 kg 3.37 lb	*27620DA	125.412 4.9375	44.450 1.7500	.8 .03	.89 kg 1.96 lb	55.560 2.1874		
*NA27691T	83.858 3.3015	27.780 1.0937	3.5 .14	1.46 kg 3.21 lb	*27626DA	136.525 5.3750	44.450 1.7500	.8 .03	1.60 kg 3.52 lb	55.560 2.1874		
27800 Series												
*27875	34.925 1.3750	23.698 .9330	.8 .03	.39 kg .86 lb	27820	80.035 3.1510	18.512 .7288	1.5 .06	.21 kg .46 lb	24.608 .9688	27875: SPECIAL BACKFACE RADIUS  27879: SPECIAL BACKFACE RADIUS	
*27880	38.100 1.5000	23.698 .9330	.8 .03	.36 kg .78 lb	*27820D	80.035 3.1510	44.958 1.7700	.8 .03	.49 kg 1.07 lb	57.150 2.2500	27880: SPECIAL BACKFACE RADIUS	
*27881	38.100 1.5000	23.698 .9330	3.5 .14	.35 kg .77 lb	27821	80.035 3.1510	17.462 .6875	1.5 .06	.19 kg .43 lb	23.812 .9375	27881: SPECIAL BACKFACE RADIUS 27820D : GROOVE IN OD CENTER HOLES IN OD CENTER	
*27879	38.100 1.5000	22.111 .8705	.8 .03	.33 kg .74 lb	27879 may be paired with all single cups corresponding to 27875 and will require -1.588 mm (-.0625 in) to be added to the T-width values. 27879 may be paired with all double cups corresponding to 27875 and will require -3.175 mm (-.1250 in) to be added to the T-width values.							
28000 Series												
28118	30.162 1.1875	20.940 .8244	1.5 .06	.34 kg .74 lb	28300	76.200 3.0000	15.507 .6105	1.3 .05	.14 kg .30 lb	20.637 .8125	28315-B: FLANGE ON OD FRONTFACE, BEARING WIDTH IS T1 DIMENSION	
28137	34.925 1.3750	20.940 .8244	1.5 .06	.30 kg .65 lb	28300X	76.200 3.0000	15.494 .6100	1.5 .06	.14 kg .31 lb	20.625 .8120	28318D: GROOVE IN OD CENTER HOLES IN OD CENTER	
28138	34.976 1.3770	20.940 .8244	1.5 .06	.30 kg .65 lb	28314XD	80.035 3.1510	34.925 1.3750	.8 .03	.46 kg 1.00 lb	46.040 1.8126		
28138X	35.000 1.3780	20.940 .8244	2.0 .08	.29 kg .65 lb	28315	80.000 3.1496	15.875 .6250	1.5 .06	.20 kg .44 lb	21.006 .8270		
28150	38.100 1.5000	20.940 .8244	1.5 .06	.27 kg .59 lb	28315A	80.000 3.1496	15.875 .6250	2.0 .08	.20 kg .43 lb	21.006 .8270		
28151	38.100 1.5000	20.940 .8244	3.5 .14	.26 kg .57 lb	*28315-B	80.000 3.1496	15.875 .6250	1.5 .06	.21 kg .47 lb	9.100 .3583		
28158	40.000 1.5748	20.940 .8244	1.5 .06	.25 kg .54 lb	28316	80.167 3.1562	15.875 .6250	1.5 .06	.20 kg .44 lb	21.006 .8270		
28159	39.980 1.5740	20.940 .8244	3.5 .14	.24 kg .53 lb	28317	80.035 3.1510	15.875 .6250	1.5 .06	.20 kg .44 lb	21.433 .8438		
					*28318D	80.035 3.1510	34.925 1.3750	.8 .03	.44 kg .96 lb	46.040 1.8126		

\*\*These Maximum Fillet Radii will be cleared by the Cone or Cup Radii.  
†Bore or O.D. shown are maximum dimensions. \*See Remarks Column.

28000 – 28900 SERIES

4

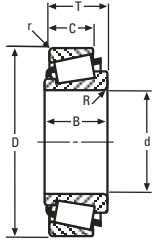

SINGLE ROW



SINGLE ROW WITH FLANGE

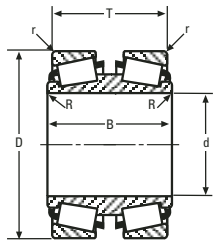

DOUBLE CONE

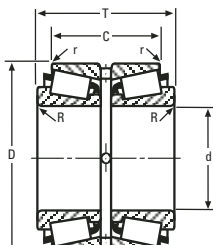

DOUBLE CUP

CONE			Max Shaft Fillet Radii R**	Weight	CUP			Max Hs'ng Fillet Radii r**	Weight	BEARING	Remarks
Number	BORE d	WIDTH B			Number	OUTSIDE DIA D	WIDTH C			WIDTH T	
<b>28000 Series (cont)</b>											
NA28138	34.976 1.3770	23.020 .9063	1.5 .06	.62 kg 1.37 lb	28314XD	80.035 3.1510	34.925 1.3750	.8 .03	.46 kg 1.00 lb	46.040 1.8126	
					*28318D	80.035 3.1510	34.925 1.3750	.8 .03	.44 kg .96 lb	46.040 1.8126	
28155	39.980 1.5740	19.649 .7736	3.5 .14	.23 kg .51 lb	28155 and grouped cones may be paired with all single cups corresponding to 28118 and will require -1.290 mm (-.0508 in) to be added to the T-width values.						
28156	39.980 1.5740	19.649 .7736	2.3 .09	.23 kg .51 lb	28155 and grouped cones may be paired with all double cups corresponding to 28118 and will require -2.581 mm (-.1016 in) to be added to the T-width values.						
<b>28500 Series</b>											
†J28573	42.000 1.6535	25.400 1.0000	.8 .03	.58 kg 1.28 lb	28520	89.980 3.5425	19.987 .7869	2.3 .09	.20 kg .43 lb	24.750 .9744	28580T: TAPERED BORE 28521-B: FLANGE ON OD FRONTFACE, BEARING WIDTH IS T1 DIMENSION 28527RB: GROOVE IN OD BACKFACE
28576	44.869 1.7665	25.400 1.0000	3.5 .14	.54 kg 1.19 lb	28521	92.075 3.6250	19.845 .7813	.8 .03	.24 kg .54 lb	24.607 .9688	
†J28577	45.000 1.7717	25.400 1.0000	.8 .03	.55 kg 1.22 lb	*28521-B	92.075 3.6250	19.845 .7813	.8 .03	.27 kg .59 lb	8.730 .3437	
28579	49.987 1.9680	25.400 1.0000	2.3 .09	.47 kg 1.04 lb	28523	92.075 3.6250	23.017 .9062	2.3 .09	.30 kg .65 lb	27.780 1.0937	
28580	50.800 2.0000	25.400 1.0000	3.5 .14	.46 kg 1.02 lb	28526	99.985 3.9364	19.845 .7813	3.3 .13	.42 kg .92 lb	24.607 .9688	
28580A	50.800 2.0000	25.400 1.0000	.8 .03	.46 kg 1.02 lb	*28527RB	99.995 3.9368	19.845 .7813	.5 .02	.43 kg .95 lb	24.607 .9688	
*28580T	50.800 2.0000	25.400 1.0000	1.5 .06	.48 kg 1.05 lb							
28584	52.388 2.0625	25.400 1.0000	3.5 .14	.43 kg .94 lb							
<b>28600 Series</b>											
28678	50.800 2.0000	24.608 .9688	3.5 .14	.57 kg 1.25 lb	28621	96.838 3.8125	19.446 .7656	.8 .03	.25 kg .55 lb	24.608 .9688	28622-B: FLANGE ON OD FRONTFACE, BEARING WIDTH IS T1 DIMENSION
28680	55.562 2.1875	24.608 .9688	3.5 .14	.49 kg 1.08 lb	28622	97.630 3.8437	19.446 .7656	.8 .03	.27 kg .59 lb	24.608 .9688	
28682	57.150 2.2500	24.608 .9688	3.5 .14	.46 kg 1.02 lb	28622A	97.630 3.8437	19.446 .7656	3.3 .13	.26 kg .58 lb	24.608 .9688	
28682P	57.150 2.2500	24.608 .9688	3.5 .14	.47 kg 1.03 lb	*28622-B	97.630 3.8437	19.446 .7656	.8 .03	.29 kg .64 lb	9.124 .3592	
					28622P	97.630 3.8437	19.446 .7656	.8 .03	.27 kg .59 lb	24.608 .9688	
					28623	98.425 3.8750	19.446 .7656	.8 .03	.29 kg .63 lb	24.608 .9688	
<b>28800 Series</b>											
*28880	247.650 9.7500	22.225 .8750	1.5 .06	2.12 kg 4.68 lb	28820	304.800 12.0000	15.875 .6250	1.5 .06	1.10 kg 2.43 lb	22.225 .8750	28880: BROKEN FRONTFACE ID
<b>28900 Series</b>											
28970	54.996 2.1652	25.400 1.0000	2.0 .08	.63 kg 1.39 lb	28919	99.979 3.9362	19.050 .7500	1.5 .06	.22 kg .48 lb	24.605 .9687	28921-B: FLANGE ON OD FRONTFACE, BEARING WIDTH IS T1 DIMENSION
28980	59.977 2.3613	25.400 1.0000	3.5 .14	.54 kg 1.18 lb	28920	101.600 4.0000	19.845 .7813	3.3 .13	.26 kg .58 lb	25.400 1.0000	
28985	60.325 2.3750	25.400 1.0000	3.5 .14	.53 kg 1.17 lb	28921	100.000 3.9370	19.845 .7813	3.3 .13	.22 kg .49 lb	25.400 1.0000	
28985W	60.325 2.3750	25.400 1.0000	3.5 .14	.54 kg 1.20 lb	28921A	100.000 3.9370	19.845 .7813	.8 .03	.24 kg .52 lb	25.400 1.0000	
28995	62.738 2.4700	25.400 1.0000	3.5 .14	.48 kg 1.06 lb	*28921-B	100.000 3.9370	19.845 .7813	3.3 .13	.26 kg .57 lb	9.525 .3750	
					*28921D	100.000 3.9370	44.450 1.7500	.8 .03	.57 kg 1.25 lb	55.560 2.1874	
					*28921DC	100.000 3.9370	44.450 1.7500	.8 .03	.57 kg 1.25 lb	55.560 2.1874	
28990	61.976 2.4400	24.608 .9688	2.0 .08	.49 kg 1.08 lb	28990 may be paired with all single cups corresponding to 28970 and will require -.792 mm (-.0312 in) to be added to the T-width values. 28990 may be paired with all double cups corresponding to 28970 and will require -1.585 mm (-.0624 in) to be added to the T-width values.						

29000 SERIES CONTINUED ON NEXT PAGE

\*\*These Maximum Fillet Radii will be cleared by the Cone or Cup Radii.  
†Bore or O.D. shown are maximum dimensions. \*See Remarks Column.

29000 – LM29700 SERIES

4

CONE			Max Shaft Fillet Radii R''	Weight	CUP			Max Hs'ng Fillet Radii r''	Weight	BEARING	Remarks
Number	BORE d	WIDTH B			Number	OUTSIDE DIA D	WIDTH C			WIDTH T	
<b>29000 Series</b>											
29168	42.862 1.6875	19.164 .7545	1.5 .06	.29 kg .65 lb	29334	84.988 3.3460	15.875 .6250	1.5 .06	.19 kg .41 lb	19.000 .7480	
29177	44.983 1.7710	19.164 .7545	2.0 .08	.27 kg .60 lb							
<b>29500 Series</b>											
29580	60.000 2.3622	25.400 1.0000	3.5 .14	.72 kg 1.58 lb	*29520-B	107.950 4.2500	19.050 .7500	3.3 .13	.31 kg .69 lb	10.320 .4063	29520-B : FLANGE ON OD FRONTFACE, BEARING WIDTH IS T1 DIMENSION
29582	60.000 2.3622	25.400 1.0000	.8 .03	.72 kg 1.60 lb	29520	107.950 4.2500	19.050 .7500	3.3 .13	.27 kg .60 lb	25.400 1.0000	29521-B : FLANGE ON OD FRONTFACE, BEARING WIDTH IS T1 DIMENSION
29585	63.500 2.5000	25.400 1.0000	3.5 .14	.65 kg 1.43 lb	*29521-B	110.000 4.3307	19.050 .7500	1.3 .05	.37 kg .80 lb	10.320 .4063	29526D : GROOVE IN OD CENTER HOLES IN OD CENTER
29585W	63.500 2.5000	25.400 1.0000	3.5 .14	.64 kg 1.41 lb	29521	110.000 4.3307	19.050 .7500	1.3 .05	.33 kg .74 lb	25.400 1.0000	29526DRB : HOLES IN OD CENTER
29586	63.500 2.5000	25.400 1.0000	1.5 .06	.66 kg 1.45 lb	29522	107.950 4.2500	19.050 .7500	.8 .03	.28 kg .62 lb	25.400 1.0000	
29588	64.988 2.5586	25.400 1.0000	3.5 .14	.62 kg 1.36 lb	*29526DRB	112.712 4.4375	42.862 1.6875	.8 .03	.93 kg 2.05 lb	55.562 2.1875	
29590	66.675 2.6250	25.400 1.0000	3.5 .14	.58 kg 1.28 lb	*29526D	112.712 4.4375	42.862 1.6875	.8 .03	.89 kg 1.96 lb	55.562 2.1875	
<b>29600 Series</b>											
29665	57.150 2.2500	25.400 1.0000	3.5 .14	.94 kg 2.07 lb	*29620-B	112.712 4.4375	19.050 .7500	3.3 .13	.30 kg .67 lb	10.320 .4063	29675V: MADE FROM VACUUM MELT STEEL
29670	63.500 2.5000	25.400 1.0000	3.5 .14	.82 kg 1.80 lb	*29620V	112.712 4.4375	19.050 .7500	3.3 .13	.26 kg .58 lb	25.400 1.0000	29685V: MADE FROM VACUUM MELT STEEL
29675	69.850 2.7500	25.400 1.0000	1.5 .06	.69 kg 1.52 lb	29620	112.712 4.4375	19.050 .7500	3.3 .13	.27 kg .60 lb	25.400 1.0000	29620-B : FLANGE ON OD FRONTFACE, BEARING WIDTH IS T1 DIMENSION
*29675V	69.850 2.7500	25.400 1.0000	1.5 .06	.69 kg 1.52 lb	*29621-B	112.712 4.4375	19.050 .7500	.8 .03	.30 kg .66 lb	10.320 .4063	29620V : MADE FROM VACUUM MELT STEEL
29676	69.850 2.7500	25.400 1.0000	1.5 .06	.69 kg 1.52 lb	*29622-BW	114.287 4.4995	19.050 .7500	3.3 .13	.35 kg .76 lb	10.320 .4063	29621-B : FLANGE ON OD FRONTFACE, BEARING WIDTH IS T1 DIMENSION
29677	70.000 2.7559	25.400 1.0000	1.5 .06	.69 kg 1.52 lb	*29622W	114.287 4.4995	19.050 .7500	3.3 .13	.32 kg .71 lb	25.400 1.0000	29622-BW : FLANGE ON OD FRONTFACE, BEARING WIDTH IS T1 DIMENSION
29680	70.637 2.7810	25.400 1.0000	1.3 .05	.67 kg 1.48 lb	*29622DV	114.287 4.4995	46.038 1.8125	.8 .03	.79 kg 1.74 lb	58.737 2.3125	29622 : GROOVE IN OD CENTER HOLES IN OD CENTER
29681	70.637 2.7810	25.400 1.0000	3.5 .14	.67 kg 1.48 lb	*29622DC	114.287 4.4995	46.038 1.8125	.8 .03	.79 kg 1.74 lb	58.737 2.3125	29622D : GROOVE IN OD CENTER HOLES IN OD CENTER
29685	73.025 2.8750	25.400 1.0000	3.5 .14	.62 kg 1.37 lb	*29622D	114.287 4.4995	46.038 1.8125	.8 .03	.79 kg 1.74 lb	58.737 2.3125	29622DC : HOLES IN OD CENTER
*29685V	73.025 2.8750	25.400 1.0000	3.5 .14	.61 kg 1.35 lb	29624	114.300 4.5000	22.225 .8750	3.3 .13	.36 kg .80 lb	27.780 1.0937	29622DV : GROOVE IN OD CENTER HOLES IN OD CENTER
29688	73.817 2.9062	25.400 1.0000	1.5 .06	.60 kg 1.33 lb	*29625WE	116.586 4.5900	23.597 .9290	.8 .03	.48 kg 1.05 lb	29.146 1.1475	MADE FROM VACUUM MELT STEEL
					29630	120.650 4.7500	19.050 .7500	3.3 .13	.48 kg 1.05 lb	25.400 1.0000	29622W : SLOTS OD SURFACE
<b>LM29700 Series</b>											
*LM29748	38.100 1.5000	18.288 .7200	spcl. spcl.	.14 kg .32 lb	LM29710	65.088 2.5625	13.970 .5500	1.3 .05	.08 kg .17 lb	18.034 .7100	LM29748: SPECIAL BACKFACE RADIUS
LM29749	38.100 1.5000	18.288 .7200	2.3 .09	.15 kg .34 lb	LM29710X	65.088 2.5625	13.970 .5500	1.3 .05	.08 kg .18 lb	18.034 .7100	LM29749C: FRONTFACE CHAMFER
*LM29749C	38.100 1.5000	18.288 .7200	2.3 .09	.15 kg .34 lb	LM29711	65.088 2.5625	15.748 .6200	1.3 .05	.09 kg .21 lb	19.812 .7800	
LM29749X	38.100 1.5000	18.288 .7200	2.3 .09	.15 kg .34 lb	LM29711C	65.088 2.5625	15.748 .6200	1.3 .05	.09 kg .21 lb	19.812 .7800	

\*These Maximum Fillet Radii will be cleared by the Cone or Cup Radii.  
†Bore or O.D. shown are maximum dimensions. \*See Remarks Column.

29800 – 33800 SERIES

5

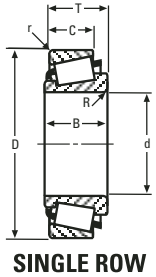

SINGLE ROW

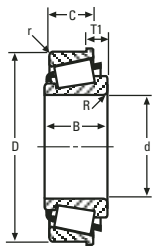

SINGLE ROW WITH FLANGE

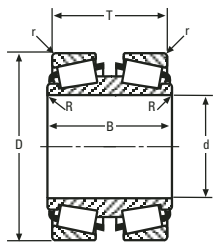

DOUBLE CONE

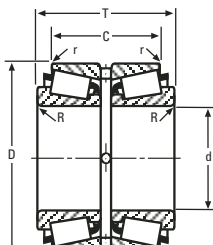

DOUBLE CUP

CONE			Max Shaft Fillet Radii R <sup>**</sup>	Weight	CUP			Max Hs'ng Fillet Radii r <sup>**</sup>	Weight	BEARING WIDTH T	Remarks
Number	BORE d	WIDTH B			Number	OUTSIDE DIA D	WIDTH C				
<b>29800 Series</b>											
29875	254.000 10.0000	22.225 .8750	1.5 .06	3.09 kg 6.81 lb	*29819	317.500 12.5000	15.875 .6250	1.6 .06	.83 kg 1.84 lb	22.224 .8750	29819 : CHAMFER ON BACKFACE OD CHAMFER ON FRONTFACE OD
29880	266.700 10.5000	22.225 .8750	1.5 .06	2.19 kg 4.82 lb	29820	323.850 12.7500	15.875 .6250	1.5 .06	1.23 kg 2.71 lb	22.224 .8750	29820D : GROOVE IN OD CENTER HOLES IN OD CENTER
29888	273.050 10.7500	22.225 .8750	1.5 .06	1.72 kg 3.79 lb	*29820DC *29820D	323.850 323.850 12.7500 12.7500	50.800 50.800 2.0000 2.0000	.8 .8 .03 .03	3.99 kg 3.99 kg 8.81 lb 8.81 lb	63.500 63.500 2.5000 2.5000	29820DC : HOLES IN OD CENTER
<b>30000 Series</b>											
30200											
30300											
31300											
32000X											
32200	SEE ISOCLASS SECTION				SEE ISOCLASS SECTION						
32300											
33000											
33100											
33200											
<b>LM31300 Series</b>											
LM31331	SEE MULTI-ROW STEERING GEAR BEARING SECTION										
LM31333											
<b>31500 Series</b>											
31590	33.338 1.3125	28.575 1.1250	.8 .03	.41 kg .91 lb	31520	76.200 3.0000	23.812 .9375	3.3 .13	.23 kg .50 lb	29.370 1.1563	31593: FRONTFACE CHAMFER
*31593	34.925 1.3750	28.575 1.1250	3.5 .14	.39 kg .86 lb	*31520-B	76.200 3.0000	23.812 .9375	spcl. spcl.	.26 kg .57 lb	10.320 .4063	31520-B : FLANGE ON OD FRONTFACE, BEARING WIDTH IS T1 DIMENSION SPECIAL RADIUS ON BACKFACE OD
31594	34.925 1.3750	28.575 1.1250	1.5 .06	.40 kg .87 lb	31521	76.200 3.0000	23.812 .9375	1.3 .05	.24 kg .52 lb	29.370 1.1563	31523RB : GROOVE IN OD FRONTFACE
31597	36.512 1.4375	28.575 1.1250	3.5 .14	.37 kg .82 lb	*31523RB	79.375 3.1250	23.812 .9375	3.3 .13	.30 kg .67 lb	29.370 1.1563	
<b>33000 Series</b>											
33225	57.150 2.2500	30.162 1.1875	3.5 .14	1.12 kg 2.47 lb	33461	117.475 4.6250	23.812 .9375	.8 .03	.44 kg .98 lb	30.162 1.1875	33225A : FRONTFACE CHAMFER
*33225A	57.150 2.2500	30.162 1.1875	.8 .03	1.12 kg 2.47 lb	33461X	117.475 4.6250	23.812 .9375	.8 .03	.44 kg .98 lb	30.162 1.1875	33462-B : FLANGE ON OD FRONTFACE, BEARING WIDTH IS T1 DIMENSION
33251	63.500 2.5000	30.162 1.1875	.8 .03	.99 kg 2.18 lb	33462	117.475 4.6250	23.812 .9375	3.3 .13	.43 kg .95 lb	30.162 1.1875	33462D : GROOVE IN OD CENTER HOLES IN OD CENTER
33261	66.675 2.6250	30.162 1.1875	5.5 .22	.89 kg 1.95 lb	*33462-B	117.475 4.6250	23.812 .9375	3.3 .13	.51 kg 1.13 lb	11.112 .4375	33462DC : HOLES IN OD CENTER
33262	66.675 2.6250	30.162 1.1875	3.5 .14	.90 kg 1.99 lb	*33462D	117.475 4.6250	53.975 2.1250	.8 .03	1.11 kg 2.45 lb	66.675 2.6250	33472DC : HOLES IN OD CENTER
33262A	66.675 2.6250	30.162 1.1875	.8 .03	.91 kg 2.01 lb	*33462DC	117.475 4.6250	53.975 2.1250	.8 .03	1.11 kg 2.45 lb	66.675 2.6250	
33269	68.262 2.6875	30.162 1.1875	3.5 .14	.86 kg 1.90 lb	33472	120.000 4.7244	23.444 .9230	.8 .03	.52 kg 1.15 lb	29.794 1.1730	
33275	69.850 2.7500	30.162 1.1875	3.5 .14	.82 kg 1.81 lb	*33472DC	120.000 4.7244	67.285 2.6490	.8 .03	1.72 kg 3.80 lb	79.908 3.1460	
33275W	69.850 2.7500	30.162 1.1875	3.5 .14	.78 kg 1.72 lb	33475	120.650 4.7500	23.444 .9230	.8 .03	.55 kg 1.20 lb	29.794 1.1730	
33281	71.438 2.8125	30.162 1.1875	3.5 .14	.78 kg 1.72 lb							
33287	73.025 2.8750	30.162 1.1875	3.5 .14	.74 kg 1.62 lb							
33287A	73.025 2.8750	30.162 1.1875	.3 .01	.75 kg 1.65 lb							
<b>HM33400 Series</b>											
†JHM33449	24.000 .9449	25.000 .9843	2.0 .08	.19 kg .42 lb	†JHM33410	55.000 2.1654	21.000 .8268	2.0 .08	.11 kg .24 lb	25.000 .9843	
<b>33800 Series</b>											
33880	38.100 1.5000	28.575 1.1250	3.5 .14	.79 kg 1.73 lb	*33820-B	93.264 3.6718	22.225 .8750	spcl. spcl.	.25 kg .55 lb	10.320 .4063	NA33889-SW: FRONTFACE CHAMFER SLOTS IN FRONTFACE
33885	44.450 1.7500	28.575 1.1250	.8 .03	.70 kg 1.54 lb	33821	95.250 3.7500	22.225 .8750	2.3 .09	.26 kg .58 lb	27.783 1.0938	NA33895-SW: FRONTFACE CHAMFER SLOTS IN FRONTFACE

33800 SERIES CONTINUED ON NEXT PAGE

\*\*These Maximum Fillet Radii will be cleared by the Cone or Cup Radii.  
†Bore or O.D. shown are maximum dimensions. \*See Remarks Column.

5

CONE			Max Shaft Fillet Radii R <sup>**</sup>	Weight	CUP			Max Hs'ng Fillet Radii r <sup>**</sup>	Weight	BEARING WIDTH T	Remarks
Number	BORE d	WIDTH B			Number	OUTSIDE DIA D	WIDTH C				
<b>33800 Series (cont)</b>											
33887X	50.000 1.9685	28.575 1.1250	6.0 .24	.58 kg 1.29 lb	*33821D	95.250 3.7500	52.385 2.0624	.8 .03	.66 kg 1.45 lb	63.500 2.5000	33820-B : FLANGE ON OD FRONTFACE, BEARING WIDTH IS T1 DIMENSION SPECIAL RADIUS ON BACKFACE OD
33889	50.800 2.0000	28.575 1.1250	3.5 .14	.59 kg 1.29 lb	*33821DC	95.250 3.7500	52.385 2.0624	.8 .03	.66 kg 1.45 lb	63.500 2.5000	
33890	52.388 2.0625	28.575 1.1250	1.5 .06	.56 kg 1.24 lb	33822	95.250 3.7500	22.225 .8750	.8 .03	.27 kg .59 lb	27.783 1.0938	33821D : GROOVE IN OD CENTER HOLES IN OD CENTER
33891	52.388 2.0625	28.575 1.1250	3.5 .14	.56 kg 1.23 lb		33821DC : GROOVE IN OD CENTER HOLES IN OD CENTER					
33895	53.975 2.1250	28.575 1.1250	1.5 .06	.53 kg 1.18 lb							K312493 : FLANGE ON OD LEFTFACE SPECIAL RADIUS ON LEFTFACE OD
*NA33889-SW	50.800 2.0000	34.925 1.3750	3.5 .14	1.31 kg 2.89 lb	*33821D	95.250 3.7500	52.385 2.0624	.8 .03	.66 kg 1.45 lb	69.850 2.7500	K426866 : FLANGE ON OD LEFTFACE
*NA33895-SW	53.975 2.1250	34.925 1.3750	3.5 .14	1.19 kg 2.62 lb	*33821DC	95.250 3.7500	52.385 2.0624	.8 .03	.66 kg 1.45 lb	69.850 2.7500	
					K100825	133.825 5.2687	68.265 2.6876	- -	3.50 kg 7.71 lb	69.850 2.7500	
					K103272	120.650 4.7500	68.265 2.6876	1.5 .06	2.91 kg 6.42 lb	69.850 2.7500	
					K106797	127.000 5.0000	68.265 2.6876	3.3 .13	3.60 kg 7.93 lb	69.850 2.7500	
					K302667	127.000 5.0000	68.265 2.6876	6.4 .25	3.60 kg 7.93 lb	69.850 2.7500	
					*K312493	127.000 5.0000	68.265 2.6876	1.5 .06	4.05 kg 8.94 lb	69.850 2.7500	
					*K426866	127.000 5.0000	68.265 2.6876	1.5 .06	4.05 kg 8.94 lb	69.850 2.7500	
					K444665	152.400 6.0000	68.265 2.6876	1.5 .06	6.58 kg 14.51 lb	69.850 2.7500	
<b>34000 Series</b>											
*34268DA	68.262 2.6875	93.662 3.6875	.8 .03	2.72 kg 6.00 lb	34472X	120.000 4.7244	16.000 .6299	2.3 .09	.24 kg .52 lb	45.986 1.8105	34268DA: ASYMMETRICAL BEARING HOLES IN OD RIGHTFACE
*34268DAA	68.262 2.6875	93.662 3.6875	.8 .03	2.72 kg 6.00 lb	*34478V	121.442 4.7812	17.462 .6875	2.0 .08	.31 kg .69 lb	49.202 1.9371	34268DAA: ASYMMETRICAL BEARING HOLES IN OD LEFTFACE
*34268DE	68.262 2.6875	114.300 4.5000	.8 .03	3.26 kg 7.18 lb	*34478RB	121.442 4.7812	17.462 .6875	2.0 .08	.32 kg .71 lb	49.202 1.9371	34268DE: EXTENDED SMALL RIB
*34268DEE	68.262 2.6875	114.300 4.5000	.8 .03	3.26 kg 7.18 lb	34478	121.442 4.7812	17.462 .6875	2.0 .08	.31 kg .68 lb	49.202 1.9371	34268DEE: EXTENDED SMALL RIB
*34275DA	69.850 2.7500	93.662 3.6875	.8 .03	2.60 kg 5.73 lb	34479	121.442 4.7812	21.844 .8600	2.0 .08	.35 kg .78 lb	49.202 1.9371	34274: FRONTFACE CHAMFER
*34275DAA	69.850 2.7500	93.662 3.6875	.8 .03	2.60 kg 5.73 lb	34492A	125.052 4.9233	16.400 .6457	2.0 .08	.38 kg .83 lb	47.450 1.8681	34274W: FRONTFACE CHAMFER
*34275DE	69.850 2.7500	114.300 4.5000	.8 .03	3.10 kg 6.84 lb	34492	125.095 4.9250	16.670 .6563	2.0 .08	.39 kg .85 lb	47.989 1.8893	34275: FRONTFACE CHAMFER
*34275DEE	69.850 2.7500	114.300 4.5000	.8 .03	3.10 kg 6.84 lb	34500	127.000 5.0000	19.842 .7812	3.3 .13	.53 kg 1.16 lb	53.962 2.1245	34275DA: ASYMMETRICAL BEARING HOLES IN OD RIGHTFACE
*34276DE	70.000 2.7559	114.300 4.5000	.8 .03	2.95 kg 6.51 lb							
*34276DEE	70.000 2.7559	114.300 4.5000	.8 .03	2.95 kg 6.51 lb							34275DAA: ASYMMETRICAL BEARING HOLES IN OD LEFTFACE
*34293DA	74.612 2.9375	93.662 3.6875	.8 .03	2.21 kg 4.88 lb							34275DE: EXTENDED SMALL RIB
*34293DAA	74.612 2.9375	93.662 3.6875	.8 .03	2.21 kg 4.88 lb							34275DEE: EXTENDED SMALL RIB
*34293DE	74.612 2.9375	114.300 4.5000	.8 .03	2.62 kg 5.77 lb							34275HV: HOLES IN BACKFACE TO UNDERCUT MADE FROM VACUUM MELT STEEL SHOULDER ON OD BACKFACE
*34293DEE	74.612 2.9375	114.300 4.5000	.8 .03	2.62 kg 5.77 lb							
*34295DE	75.000 2.9528	114.300 4.5000	.8 .03	2.45 kg 5.41 lb							34276DE: EXTENDED SMALL RIB
*34295DEE	75.000 2.9528	114.300 4.5000	.8 .03	2.45 kg 5.41 lb							34276DEE: EXTENDED SMALL RIB
*34300DA	76.200 3.0000	93.662 3.6875	.8 .03	2.08 kg 4.59 lb							
*34300DAA	76.200 3.0000	93.662 3.6875	.8 .03	2.08 kg 4.59 lb							34293DA: ASYMMETRICAL BEARING HOLES IN OD RIGHTFACE

\*\*These Maximum Fillet Radii will be cleared by the Cone or Cup Radii.  
†Bore or O.D. shown are maximum dimensions. \*See Remarks Column.

34000 – 35000 SERIES

5

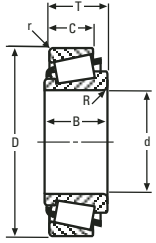

SINGLE ROW



SINGLE ROW WITH FLANGE

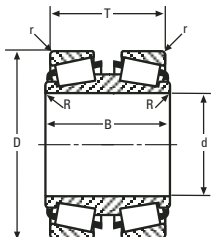

DOUBLE CONE

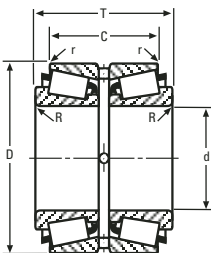

DOUBLE CUP

CONE			Max Shaft Fillet Radii R <sup>**</sup>	Weight	CUP			Max Hs'ng Fillet Radii r <sup>**</sup>	Weight	BEAR-ING	Remarks
Number	BORE d	WIDTH B			Number	OUTSIDE DIA D	WIDTH C			WIDTH T	
<b>34000 Series (cont)</b>											
*34300DE	76.200 3.0000	114.300 4.5000	.8 .03	2.36 kg 5.21 lb							34293DAA: ASYMMETRICAL BEARING HOLES IN OD LEFTFACE
*34300DEE	76.200 3.0000	114.300 4.5000	.8 .03	2.36 kg 5.21 lb							34293DE: EXTENDED SMALL RIB
*34274	69.952 2.7540	23.012 .9060	2.0 .08	.77 kg 1.71 lb	34472X	120.000 4.7244	16.000 .6299	2.3 .09	.24 kg .52 lb	23.000 .9055	34293DEE: EXTENDED SMALL RIB
*34274W	69.952 2.7540	23.012 .9060	2.0 .08	.76 kg 1.68 lb	*34478-B	121.442 4.7812	17.462 .6875	1.5 .06	.35 kg .78 lb	11.907 .4688	34294: FRONTFACE CHAMFER
*34275	70.000 2.7559	23.012 .9060	2.0 .08	.77 kg 1.70 lb	*34478V	121.442 4.7812	17.462 .6875	2.0 .08	.31 kg .69 lb	24.607 .9688	34294DA: ASYMMETRICAL BEARING HOLES IN OD RIGHTFACE
*34275HV	70.000 2.7559	23.012 .9060	2.0 .08	.79 kg 1.74 lb	*34478RB	121.442 4.7812	17.462 .6875	2.0 .08	.32 kg .71 lb	24.607 .9688	34295DE: EXTENDED SMALL RIB
*34294	74.976 2.9518	23.012 .9060	2.0 .08	.67 kg 1.48 lb	34478	121.442 4.7812	17.462 .6875	2.0 .08	.31 kg .68 lb	24.607 .9688	34295DEE: EXTENDED SMALL RIB
*34299X	76.000 2.9921	23.012 .9060	2.3 .09	.65 kg 1.43 lb	*34478DC	121.442 4.7812	38.100 1.5000	.8 .03	.63 kg 1.39 lb	52.390 2.0626	34299X: FRONTFACE CHAMFER
*34300	76.200 3.0000	23.012 .9060	2.0 .08	.65 kg 1.43 lb	*34478D	121.442 4.7812	38.100 1.5000	.8 .03	.63 kg 1.39 lb	52.390 2.0626	34300: FRONTFACE CHAMFER
*34300A	76.200 3.0000	23.012 .9060	2.0 .08	.64 kg 1.42 lb	34479	121.442 4.7812	21.844 .8600	2.0 .08	.35 kg .78 lb	24.608 .9688	34300A: SPECIAL FRONTFACE RADIUS
*34301	76.200 3.0000	23.012 .9060	3.5 .14	.64 kg 1.40 lb	*34481-B	122.238 4.8125	21.430 .8437	2.0 .08	.41 kg .90 lb	7.940 .3126	34300DA: ASYMMETRICAL BEARING HOLES IN OD RIGHTFACE
*34304	77.356 3.0455	23.012 .9060	3.5 .14	.61 kg 1.35 lb	34492A	125.052 4.9233	16.400 .6457	2.0 .08	.38 kg .83 lb	23.731 .9343	
*34306	77.788 3.0625	23.012 .9060	3.5 .14	.60 kg 1.33 lb	34492	125.095 4.9250	16.670 .6563	2.0 .08	.39 kg .85 lb	24.000 .9449	34300DAA: ASYMMETRICAL BEARING HOLES IN OD LEFTFACE
*34306W	77.788 3.0625	23.012 .9060	1.5 .06	.58 kg 1.28 lb	34500	127.000 5.0000	19.842 .7812	3.3 .13	.53 kg 1.16 lb	26.987 1.0625	34300DE: EXTENDED SMALL RIB
*34307	77.788 3.0625	23.012 .9060	6.4 .25	.57 kg 1.26 lb							34300DEE: EXTENDED SMALL RIB
											34301: FRONTFACE CHAMFER
											34304: FRONTFACE CHAMFER
											34306: FRONTFACE CHAMFER
											34306W: FRONTFACE CHAMFER
											34307: FRONTFACE CHAMFER
											34478-B : FLANGE ON OD FRONTFACE, BEARING WIDTH IS T1 DIMENSION
											34478D : GROOVE IN OD CENTER HOLES IN OD CENTER
											34478DC : HOLES IN OD CENTER
											34478RB : GROOVE IN OD FRONTFACE
											34478V : MADE FROM VACUUM MELT STEEL
											34481-B : FLANGE ON OD FRONTFACE, BEARING WIDTH IS T1 DIMENSION
*34294DA	74.612 2.9375	94.082 3.7040	.8 .03	2.20 kg 4.84 lb	34294DA may be paired with all single cups corresponding to 34268DA and will require -.3178 mm (-.1251 in) to be added to the T-width values.						
<b>35000 Series</b>											
35175	44.450 1.7500	23.012 .9060	3.5 .14	.33 kg .73 lb	*35326-B	82.931 3.2650	17.462 .6875	.8 .03	- -	9.525 .3750	35326-B : FLANGE ON OD FRONTFACE, BEARING WIDTH IS T1 DIMENSION
35176	44.450 1.7500	23.012 .9060	.8 .03	.34 kg .75 lb	35326	82.931 3.2650	17.462 .6875	.8 .03	.15 kg .34 lb	22.225 .8750	

36000 SERIES CONTINUED ON NEXT PAGE

\*\*These Maximum Fillet Radii will be cleared by the Cone or Cup Radii.  
†Bore or O.D. shown are maximum dimensions. \*See Remarks Column.

CONE			Max Shaft Fillet Radii R <sup>**</sup>	Weight	CUP			Max Hs'ng Fillet Radii r <sup>**</sup>	Weight	BEARING	Remarks	
Number	BORE d	WIDTH B			Number	OUTSIDE DIA D	WIDTH C			WIDTH T		
<b>36000 Series</b>												
36137	34.925 1.3750	29.845 1.1750	1.5 .06	.39 kg .86 lb	36300	76.200 3.0000	23.812 .9375	3.3 .13	.23 kg .51 lb	29.370 1.1563		
<b>36600 Series</b>												
36686	142.875 5.6250	28.575 1.1250	1.5 .06	1.71 kg 3.77 lb	36620	193.675 7.6250	23.020 .9063	1.5 .06	.72 kg 1.59 lb	28.575 1.1250	36620-B : FLANGE ON OD FRONTFACE, BEARING WIDTH IS T1 DIMENSION	
36690	146.050 5.7500	28.575 1.1250	1.5 .06	1.55 kg 3.41 lb	*36620-B	193.675 7.6250	23.020 .9063	1.5 .06	.77 kg 1.69 lb	9.525 .3750	36620D : GROOVE IN OD CENTER HOLES IN OD CENTER	
36690P	146.050 5.7500	28.575 1.1250	1.5 .06	1.58 kg 3.48 lb	*36620D	193.675 7.6250	53.975 2.1250	.8 .03	1.70 kg 3.76 lb	65.084 2.5624	36620DC : HOLES IN OD CENTER	
36691	146.050 5.7500	28.575 1.1250	4.8 .19	1.51 kg 3.33 lb	*36620DC	193.675 7.6250	53.975 2.1250	.8 .03	1.71 kg 3.77 lb	65.084 2.5624		
					36620P	193.675 7.6250	23.020 .9063	1.5 .06	.72 kg 1.59 lb	28.575 1.1250		
					36626	203.200 8.0000	23.020 .9063	1.5 .06	1.25 kg 2.76 lb	28.575 1.1250		
<b>36900 Series</b>												
36990	177.800 7.0000	30.162 1.1875	1.5 .06	2.00 kg 4.41 lb	36920	227.012 8.9375	23.020 .9063	1.5 .06	.90 kg 1.98 lb	30.163 1.1875	36920CD : GROOVE IN OD CENTER HOLES IN OD CENTER	
					*36920CD	227.012 8.9375	52.388 2.0625	.8 .03	2.06 kg 4.54 lb	66.673 2.6249		
<b>37000 Series</b>												
*37425	107.950 4.2500	21.438 .8440	3.5 .14	.88 kg 1.94 lb	37624	158.750 6.2500	15.875 .6250	1.0 .04	.50 kg 1.09 lb	23.020 .9063	37425: FRONTFACE CHAMFER	
*37431	109.538 4.3125	21.438 .8440	3.5 .14	.84 kg 1.84 lb	*37625-B	158.750 6.2500	15.875 .6250	3.3 .13	.55 kg 1.21 lb	11.908 .4688	37431: FRONTFACE CHAMFER	
*37431A	109.538 4.3125	21.438 .8440	5.0 .20	.83 kg 1.83 lb	*37625RB	158.750 6.2500	15.875 .6250	3.3 .13	.51 kg 1.12 lb	23.020 .9063	37431A: FRONTFACE CHAMFER	
*37431AX	109.538 4.3125	21.438 .8440	5.0 .20	.83 kg 1.83 lb	37625	158.750 6.2500	15.875 .6250	3.3 .13	.47 kg 1.04 lb	23.020 .9063	37431AX: FRONTFACE CHAMFER	
*37431W	109.538 4.3125	21.438 .8440	3.5 .14	.83 kg 1.82 lb	*37626DC	158.750 6.2500	39.688 1.5625	.8 .03	1.29 kg 2.85 lb	53.978 2.1251	37431W: FRONTFACE CHAMFER	
					*37626D	158.750 6.2500	39.688 1.5625	.8 .03	1.29 kg 2.85 lb	53.978 2.1251	37625-B : FLANGE ON OD FRONTFACE, BEARING WIDTH IS T1 DIMENSION	
											37625RB : GROOVE IN OD FRONTFACE	
											37626D : GROOVE IN OD CENTER HOLES IN OD CENTER	
											37626DC : HOLES IN OD CENTER	
<b>M38500 Series</b>												
M38545	33.338 1.3125	20.638 .8125	3.5 .14	.23 kg .51 lb	M38510	66.675 2.6250	16.670 .6563	2.3 .09	.11 kg .24 lb	20.638 .8125	M38545T: TAPERED BORE	
*M38545T	33.338 1.3125	20.638 .8125	.8 .03	.23 kg .51 lb	M38511	65.987 2.5979	16.670 .6563	2.3 .09	.10 kg .22 lb	20.638 .8125		
M38547	34.988 1.3775	20.638 .8125	3.5 .14	.22 kg .48 lb	M38512	66.421 2.6150	16.670 .6563	2.3 .09	.11 kg .23 lb	20.638 .8125		
M38549	34.925 1.3750	20.638 .8125	3.5 .14	.22 kg .48 lb	M38514	68.262 2.6875	16.670 .6563	2.3 .09	.13 kg .29 lb	20.638 .8125		
M38549H	34.925 1.3750	20.638 .8125	3.5 .14	.22 kg .49 lb								
<b>38800 Series</b>												
38880	263.525 10.3750	28.575 1.1250	1.5 .06	3.33 kg 7.35 lb	38820	325.438 12.8125	25.400 1.0000	1.5 .06	1.88 kg 4.14 lb	28.575 1.1250	38884: EXTENDED SMALL RIB SPECIAL FRONTFACE RADIUS	
38885	266.700 10.5000	28.575 1.1250	1.5 .06	3.04 kg 6.70 lb							38886: EXTENDED SMALL RIB SPECIAL FRONTFACE RADIUS	
*38884	266.560 10.4945	33.470 1.3177	1.5 .06	3.47 kg 7.65 lb	38884 and grouped cones may be paired with all single cups corresponding to 38880 and will require .925 mm (.0364 in) to be added to the T-width values.							
*38886	266.700 10.5000	33.470 1.3177	1.5 .06	3.45 kg 7.61 lb								
<b>39000 Series</b>												
*39225DA	57.150 2.2500	84.125 3.3120	.8 .03	1.97 kg 4.35 lb	39412	104.775 4.1250	15.875 .6250	2.0 .08	.18 kg .40 lb	42.853 1.6871	39224DA: ASYMMETRICAL BEARING HOLES IN OD LEFTFACE	

\*\*These Maximum Fillet Radii will be cleared by the Cone or Cup Radii.  
†Bore or O.D. shown are maximum dimensions. \*See Remarks Column.

39000 – 39500 SERIES

5

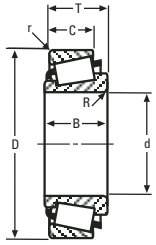

SINGLE ROW



SINGLE ROW WITH FLANGE

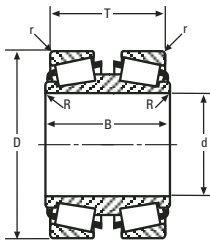

DOUBLE CONE

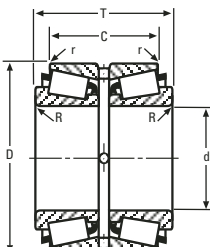

DOUBLE CUP

CONE			Max Shaft Fillet Radii R <sup>**</sup>	Weight	CUP			Max Hs'ng Fillet Radii r <sup>**</sup>	Weight	BEARING WIDTH T	Remarks
Number	BORE d	WIDTH B			Number	OUTSIDE DIA D	WIDTH C				
<b>39000 Series (cont)</b>											
*39225DAA	57.150 2.2500	84.125 3.3120	.8 .03	1.97 kg 4.35 lb	39414X	105.000 4.1339	16.000 .6299	2.0 .08	.19 kg .42 lb	43.985 1.7317	39225DA: ASYMMETRICAL BEARING HOLES IN OD LEFTFACE
*39225DE	57.150 2.2500	101.600 4.0000	.8 .03	2.20 kg 4.84 lb	39415X	105.500 4.1535	21.000 .8268	2.0 .08	.28 kg .62 lb	50.991 2.0075	39225DAA: ASYMMETRICAL BEARING HOLES IN OD LEFTFACE
*39225DEE	57.150 2.2500	101.600 4.0000	.8 .03	2.20 kg 4.84 lb	39422	107.158 4.2188	21.204 .8348	2.3 .09	.28 kg .62 lb	43.985 1.7317	39225DE: EXTENDED SMALL RIB
*39236DE	60.000 2.3622	101.600 4.0000	.8 .03	1.97 kg 4.35 lb	39433	110.058 4.3330	17.236 .6786	2.3 .09	.31 kg .69 lb	43.985 1.7317	39225DEE: EXTENDED SMALL RIB
*39236DEE	60.000 2.3622	101.600 4.0000	.8 .03	1.97 kg 4.34 lb							39236: FRONTFACE CHAMFER
*39243DA	61.912 2.4375	84.125 3.3120	.8 .03	1.67 kg 3.69 lb							39236DE: EXTENDED SMALL RIB
*39243DAA	61.912 2.4375	84.125 3.3120	.8 .03	1.67 kg 3.69 lb							39236DEE: EXTENDED SMALL RIB
*39243DE	61.912 2.4375	101.600 4.0000	.8 .03	1.84 kg 4.07 lb							39243DA: ASYMMETRICAL BEARING HOLES IN OD LEFTFACE
*39243DEE	61.912 2.4375	101.600 4.0000	.8 .03	1.84 kg 4.07 lb							39243DAA: ASYMMETRICAL BEARING HOLES IN OD LEFTFACE
*39250DA	63.500 2.5000	84.125 3.3120	.8 .03	1.57 kg 3.46 lb							39243DE: EXTENDED SMALL RIB
*39250DAA	63.500 2.5000	84.125 3.3120	.8 .03	1.57 kg 3.46 lb							39243DEE: EXTENDED SMALL RIB
*39250DE	63.500 2.5000	101.600 4.0000	.8 .03	1.72 kg 3.80 lb							39250: FRONTFACE CHAMFER
*39250DEE	63.500 2.5000	101.600 4.0000	.8 .03	1.72 kg 3.80 lb							39250DA: ASYMMETRICAL BEARING HOLES IN OD LEFTFACE
*39255DA	65.000 2.5591	84.125 3.3120	.8 .03	1.45 kg 3.20 lb							39250DAA: ASYMMETRICAL BEARING HOLES IN OD LEFTFACE
*39255DE	65.000 2.5591	101.600 4.0000	.8 .03	1.59 kg 3.50 lb							
*39255DEE	65.000 2.5591	101.600 4.0000	.8 .03	1.59 kg 3.50 lb							
*39236	59.987 2.3617	22.000 .8661	2.3 .09	.55 kg 1.22 lb	*39412-B	104.775 4.1250	15.875 .6250	2.0 .08	.22 kg .48 lb	10.320 .4063	39250DE: EXTENDED SMALL RIB
*39250	63.500 2.5000	22.000 .8661	2.0 .08	.50 kg 1.10 lb	39412	104.775 4.1250	15.875 .6250	2.0 .08	.18 kg .40 lb	21.433 .8438	39250DEE: EXTENDED SMALL RIB
*39252X	64.000 2.5197	22.000 .8661	2.3 .09	.48 kg 1.07 lb	39414X	105.000 4.1339	16.000 .6299	2.0 .08	.19 kg .42 lb	22.000 .8661	39251DE: EXTENDED SMALL RIB
					39415X	105.500 4.1535	21.000 .8268	2.0 .08	.28 kg .62 lb	25.502 1.0040	39252X: FRONTFACE CHAMFER
					39422	107.158 4.2188	21.204 .8348	2.3 .09	.28 kg .62 lb	22.000 .8661	39255DA: ASYMMETRICAL BEARING HOLES IN OD LEFTFACE
					39433	110.058 4.3330	17.236 .6786	2.3 .09	.31 kg .69 lb	22.000 .8661	39255DE: EXTENDED SMALL RIB
											39255DEE: EXTENDED SMALL RIB
											39412-B : FLANGE ON OD FRONTFACE, BEARING WIDTH IS T1 DIMENSION
*39224DA	55.562 2.1875	86.144 3.3915	.8 .03	2.12 kg 4.68 lb	39224DA may be paired with all single cups corresponding to 39225DA and will require .010 mm (.0004 in) to be added to the T-width values.						
*39251DE	63.602 2.5040	93.500 3.6811	1.0 .04	1.70 kg 3.75 lb	39251DE may be paired with all single cups corresponding to 39225DA and will require 6.147 mm (.2420 in) to be added to the T-width values.						
<b>39500 Series</b>											
39573	50.800 2.0000	30.162 1.1875	.8 .03	1.16 kg 2.56 lb	39520	112.712 4.4375	23.812 .9375	3.3 .13	.36 kg .79 lb	30.163 1.1875	39585XX: MADE FROM VACUUM MELT STEEL
39575	50.800 2.0000	30.162 1.1875	3.5 .14	1.16 kg 2.55 lb	*39520-B	112.712 4.4375	23.812 .9375	3.3 .13	.43 kg .96 lb	11.908 .4688	39590XX: MADE FROM VACUUM MELT STEEL
39578	53.975 2.1250	30.162 1.1875	3.5 .14	1.09 kg 2.41 lb	*39520-BXX	112.712 4.4375	23.812 .9375	3.3 .13	.43 kg .96 lb	11.908 .4688	39520-B : FLANGE ON OD FRONTFACE, BEARING WIDTH IS T1 DIMENSION

39500 SERIES CONTINUED ON NEXT PAGE

\*\*These Maximum Fillet Radii will be cleared by the Cone or Cup Radii.  
†Bore or O.D. shown are maximum dimensions. \*See Remarks Column.



CONE			Max Shaft Fillet Radii R''	Weight	CUP			Max Hs'ng Fillet Radii r''	Weight	BEAR-ING	Remarks
Number	BORE d	WIDTH B			Number	OUTSIDE DIA D	WIDTH C			WIDTH T	
<b>39500 Series (cont)</b>											
39580	57.150 2.2500	30.162 1.1875	3.5 .14	1.03 kg 2.26 lb	*39520DC 112.712 4.4375	55.562 2.1875	.8 .03	.88 kg 1.94 lb	68.263 2.6875	39520-BXX : FLANGE ON OD FRONTFACE, BEARING WIDTH IS T1 DIMENSION MADE FROM VACUUM MELT STEEL  39520DC : GROOVE IN OD CENTER HOLES IN OD CENTER  39520XX : MADE FROM VACUUM MELT STEEL	
39581	57.150 2.2500	30.162 1.1875	8.0 .31	.99 kg 2.18 lb	39520P 112.712 4.4375	23.812 .9375	3.3 .13	.35 kg .77 lb	30.163 1.1875		
39582A	60.000 2.3622	30.162 1.1875	.8 .03	.98 kg 2.15 lb	*39520XX 112.712 4.4375	23.812 .9375	3.3 .13	.36 kg .79 lb	30.163 1.1875		
†J39582	60.000 2.3622	31.000 1.2205	3.5 .14	.98 kg 2.15 lb	39521 112.712 4.4375	23.812 .9375	.8 .03	.36 kg .80 lb	30.163 1.1875		
39585	63.500 2.5000	30.162 1.1875	3.5 .14	.88 kg 1.95 lb	39522 112.712 4.4375	30.162 1.1875	3.3 .13	.46 kg 1.02 lb	36.513 1.4375		
39585A	63.500 2.5000	30.162 1.1875	.8 .03	.89 kg 1.97 lb	39528 119.985 4.7238	26.949 1.0610	.8 .03	.70 kg 1.55 lb	32.751 1.2894		
39585P	63.500 2.5000	30.162 1.1875	3.5 .14	.90 kg 1.99 lb							
*39585XX	63.500 2.5000	30.162 1.1875	3.5 .14	.90 kg 1.98 lb							
39586	64.988 2.5586	30.924 1.2175	2.3 .09	.86 kg 1.90 lb							
39589	66.675 2.6250	30.162 1.1875	1.5 .06	.82 kg 1.80 lb							
39590	66.675 2.6250	30.162 1.1875	3.5 .14	.81 kg 1.80 lb							
39590A	66.650 2.6240	30.162 1.1875	3.5 .14	.80 kg 1.77 lb							
*39590XX	66.675 2.6250	30.162 1.1875	3.5 .14	.82 kg 1.81 lb							
39591	66.675 2.6250	30.162 1.1875	5.5 .22	.79 kg 1.74 lb							
39585D	63.500 2.5000	60.325 2.3750	.8 .03	2.14 kg 4.73 lb	39520 112.712 4.4375	23.812 .9375	3.3 .13	.36 kg .79 lb	60.325 2.3750		
					39520P 112.712 4.4375	23.812 .9375	3.3 .13	.35 kg .77 lb	60.325 2.3750		
					*39520XX 112.712 4.4375	23.812 .9375	3.3 .13	.36 kg .79 lb	60.325 2.3750		
					39521 112.712 4.4375	23.812 .9375	.8 .03	.36 kg .80 lb	60.325 2.3750		
					39522 112.712 4.4375	30.162 1.1875	3.3 .13	.46 kg 1.02 lb	73.025 2.8750		
					39528 119.985 4.7238	26.949 1.0610	.8 .03	.70 kg 1.55 lb	65.502 2.5788		
<b>41000 Series</b>											
41100	25.400 1.0000	24.257 .9550	2.3 .09	.32 kg .70 lb	*41286-B 72.626 2.8593	17.462 .6875	1.5 .06	.20 kg .45 lb	12.700 .5000	41125W: SPECIAL BACKFACE RADIUS	
41106	26.988 1.0625	24.257 .9550	2.3 .09	.30 kg .67 lb	41286 72.626 2.8593	17.462 .6875	1.5 .06	.18 kg .39 lb	24.607 .9688	NA41125: SPECIAL BACKFACE RADIUS 41286-B : FLANGE ON OD FRONTFACE, BEARING WIDTH IS T1 DIMENSION	
41125	28.575 1.1250	24.257 .9550	4.8 .19	.28 kg .63 lb	*41294D 74.612 2.9375	41.275 1.6250	1.5 .06	.50 kg 1.09 lb	55.565 2.1876	41294D : GROOVE IN OD CENTER HOLES IN OD CENTER	
*41125W	28.575 1.1250	24.257 .9550	2.3 .09	.29 kg .64 lb							
41126	28.575 1.1250	24.257 .9550	1.5 .06	.29 kg .65 lb							
*NA41125	28.575 1.1250	27.783 1.0938	2.3 .09	- -	*41294D 74.612 2.9375	41.275 1.6250	1.5 .06	.50 kg 1.09 lb	55.565 2.1876		
<b>42000 Series</b>											
*42314DE	80.000 3.1496	127.000 5.0000	.8 .03	6.02 kg 13.28 lb	42584 148.430 5.8437	21.433 .8438	3.0 .12	.55 kg 1.22 lb	57.150 2.2500	42314DE: EXTENDED SMALL RIB	
*42314DEE	80.000 3.1496	127.000 5.0000	.8 .03	6.02 kg 13.28 lb	*42584XX 148.430 5.8437	21.433 .8438	3.0 .12	.55 kg 1.22 lb	57.150 2.2500	42314DEE: EXTENDED SMALL RIB	
*42318DA	80.962 3.1875	106.362 4.1875	.8 .03	5.24 kg 11.55 lb	42585 148.430 5.8437	25.400 1.0000	3.3 .13	.59 kg 1.29 lb	57.150 2.2500	42318DA: ASYMMETRICAL BEARING HOLES IN OD LEFTFACE	
*42318DAA	80.962 3.1875	106.362 4.1875	.8 .03	5.24 kg 11.55 lb	42586 148.430 5.8437	31.750 1.2500	3.3 .13	.85 kg 1.88 lb	69.850 2.7500	42318DAA: ASYMMETRICAL BEARING HOLES IN OD LEFTFACE	

†These Maximum Fillet Radii will be cleared by the Cone or Cup Radii.  
†Bore or O.D. shown are maximum dimensions. \*See Remarks Column.

42000 SERIES

5

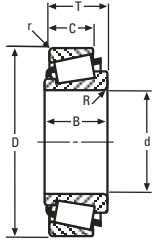

SINGLE ROW



SINGLE ROW WITH FLANGE

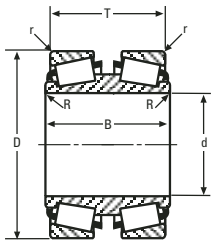

DOUBLE CONE

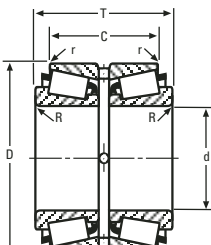

DOUBLE CUP

CONE			Max Shaft Fillet Radii R <sup>**</sup>	Weight	CUP			Max Hs'ng Fillet Radii r <sup>**</sup>	Weight	BEAR-ING	Remarks
Number	BORE d	WIDTH B			Number	OUTSIDE DIA D	WIDTH C			WIDTH T	
42000 Series (cont)											
*42318DE	80.962 3.1875	127.000 5.0000	.8 .03	5.88 kg 12.96 lb	42587	149.225 5.8750	24.608 .9688	3.3 .13	.69 kg 1.53 lb	63.500 2.5000	42318DE: EXTENDED SMALL RIB
*42318DEE	80.962 3.1875	127.000 5.0000	.8 .03	5.88 kg 12.96 lb	42590	149.974 5.9045	24.608 .9688	3.3 .13	.73 kg 1.60 lb	63.500 2.5000	42318DEE: EXTENDED SMALL RIB
*42325DE	82.550 3.2500	127.000 5.0000	.8 .03	5.71 kg 12.60 lb							42325DE: EXTENDED SMALL RIB
*42325DEE	82.550 3.2500	127.000 5.0000	.8 .03	5.71 kg 12.60 lb							42325DEE: EXTENDED SMALL RIB
*42334DE	85.000 3.3465	127.000 5.0000	.8 .03	5.39 kg 11.88 lb							42334DE: EXTENDED SMALL RIB
*42334DEE	85.000 3.3465	127.000 5.0000	.8 .03	5.39 kg 11.88 lb							42334DEE: EXTENDED SMALL RIB
*42343DA	87.312 3.4375	106.362 4.1875	.8 .03	4.55 kg 10.04 lb							42342DA: ASYMMETRICAL BEARING HOLES IN OD LEFTFACE
*42343DAA	87.312 3.4375	106.362 4.1875	.8 .03	4.55 kg 10.04 lb							42343DAA: ASYMMETRICAL BEARING HOLES IN OD LEFTFACE
*42343DE	87.312 3.4375	127.000 5.0000	.8 .03	5.08 kg 11.21 lb							42343DA: ASYMMETRICAL BEARING HOLES IN OD LEFTFACE
*42343DEE	87.312 3.4375	127.000 5.0000	.8 .03	5.08 kg 11.21 lb							42343DAA: ASYMMETRICAL BEARING HOLES IN OD LEFTFACE
*42350DA	88.900 3.5000	106.362 4.1875	.8 .03	4.37 kg 9.64 lb							42343DE: EXTENDED SMALL RIB
*42350DAA	88.900 3.5000	106.362 4.1875	.8 .03	4.37 kg 9.64 lb							42343DEE: EXTENDED SMALL RIB
*42350DE	88.900 3.5000	127.000 5.0000	.8 .03	4.87 kg 10.75 lb							42349DA: ASYMMETRICAL BEARING HOLES IN OD LEFTFACE
*42350DEE	88.900 3.5000	127.000 5.0000	.8 .03	4.87 kg 10.75 lb							42350DA: ASYMMETRICAL BEARING HOLES IN OD LEFTFACE
*42354DE	90.000 3.5433	127.000 5.0000	.8 .03	4.71 kg 10.39 lb							42350DAA: ASYMMETRICAL BEARING HOLES IN OD LEFTFACE
*42354DEE	90.000 3.5433	127.000 5.0000	.8 .03	4.71 kg 10.39 lb							42350DE: EXTENDED SMALL RIB
42362D	92.075 3.6250	57.942 2.2812	1.5 .06	3.18 kg 7.02 lb							42350DEE: EXTENDED SMALL RIB
*42363D	92.075 3.6250	59.929 2.3594	1.5 .06	3.21 kg 7.07 lb							42363D: ASYMMETRICAL BEARING EXTENDED SMALL RIB SHOULDER ON OD RIGHTFACE
42346	87.960 3.4630	28.971 1.1406	3.0 .12	1.42 kg 3.12 lb	42584	148.430 5.8437	21.433 .8438	3.0 .12	.55 kg 1.22 lb	28.575 1.1250	42350DE: EXTENDED SMALL RIB
42350	88.900 3.5000	28.971 1.1406	3.0 .12	1.39 kg 3.06 lb	*42584XX	148.430 5.8437	21.433 .8438	3.0 .12	.55 kg 1.22 lb	28.575 1.1250	42354DE: EXTENDED SMALL RIB
42354X	90.000 3.5433	28.971 1.1406	3.0 .12	1.35 kg 2.98 lb	42585	148.430 5.8437	25.400 1.0000	3.3 .13	.59 kg 1.29 lb	28.575 1.1250	42354DEE: EXTENDED SMALL RIB
42362	92.075 3.6250	28.971 1.1406	3.5 .14	1.28 kg 2.82 lb	42586	148.430 5.8437	31.750 1.2500	3.3 .13	.85 kg 1.88 lb	34.925 1.3750	42363D: ASYMMETRICAL BEARING EXTENDED SMALL RIB SHOULDER ON OD RIGHTFACE
42368	93.662 3.6875	28.971 1.1406	3.0 .12	1.23 kg 2.72 lb	42587	149.225 5.8750	24.608 .9688	3.3 .13	.69 kg 1.53 lb	31.750 1.2500	42584XX: MADE FROM VACUUM MELT STEEL
42373	94.976 3.7392	28.971 1.1406	3.0 .12	1.20 kg 2.64 lb	*42587-B	149.225 5.8750	24.608 .9688	3.3 .13	.75 kg 1.66 lb	12.700 5.000	42587-B: FLANGE ON OD FRONTFACE, BEARING WIDTH IS T1 DIMENSION
42375	95.250 3.7500	28.971 1.1406	3.0 .12	1.19 kg 2.62 lb	*42587D	149.225 5.8750	52.388 2.0625	.8 .03	1.61 kg 3.55 lb	66.672 2.6249	42587D: GROOVE IN OD CENTER HOLES IN OD CENTER
42375A	95.250 3.7500	28.971 1.1406	.8 .03	1.19 kg 2.62 lb	*42587DC	149.225 5.8750	52.388 2.0625	.8 .03	1.61 kg 3.55 lb	66.672 2.6249	42587DC: HOLES IN OD CENTER
42376	95.250 3.7500	28.971 1.1406	3.5 .14	1.17 kg 2.59 lb	42590	149.974 5.9045	24.608 .9688	3.3 .13	.73 kg 1.60 lb	31.750 1.2500	42375A: GROOVE IN OD CENTER HOLES IN OD CENTER
42381	96.838 3.8125	28.971 1.1406	3.5 .14	1.12 kg 2.47 lb							
*42342DA	87.312 3.4375	108.720 4.2803	.8 .03	4.63 kg 10.20 lb	42342DA and grouped cones may be paired with all single cups corresponding to 42314DE and will require -2.380 mm (-.0937 in) to be added to the T-width values.						
*42349DA	88.900 3.5000	108.720 4.2803	.8 .03	4.44 kg 9.79 lb							

42600 SERIES CONTINUED ON NEXT PAGE

\*\*These Maximum Fillet Radii will be cleared by the Cone or Cup Radii.  
†Bore or O.D. shown are maximum dimensions. \*See Remarks Column.

CONE			Max Shaft Fillet Radii R''	Weight	CUP			Max Hs'ng Fillet Radii r''	Weight	BEAR-ING	Remarks
Number	BORE d	WIDTH B			Number	OUTSIDE DIA D	WIDTH C			WIDTH T	
<b>42600 Series</b>											
42683	73.025 2.8750	31.000 1.2205	3.5 .14	1.09 kg 2.40 lb	*42620-B	127.000 5.0000	22.225 .8750	3.3 .13	.49 kg 1.08 lb	13.495 .5313	42620-B : FLANGE ON OD FRONTFACE, BEARING WIDTH IS T1 DIMENSION
42686	74.988 2.9523	31.000 1.2205	6.4 .25	1.01 kg 2.22 lb	42620	127.000 5.0000	22.225 .8750	3.3 .13	.43 kg .94 lb	30.163 1.1875	42623-B : FLANGE ON OD FRONTFACE, BEARING WIDTH IS T1 DIMENSION
42687	76.200 3.0000	31.000 1.2205	3.5 .14	1.01 kg 2.22 lb	*42623-B	130.000 5.1181	22.225 .8750	3.3 .13	.62 kg 1.36 lb	13.495 .5313	
42687A	76.200 3.0000	31.000 1.2205	1.3 .05	1.01 kg 2.23 lb	42624	129.974 5.1171	27.000 1.0630	2.3 .09	.67 kg 1.48 lb	33.248 1.3090	
42688	76.200 3.0000	31.000 1.2205	6.4 .25	.97 kg 2.14 lb							
42690	77.788 3.0625	31.000 1.2205	3.5 .14	.95 kg 2.10 lb							
42690H	77.788 3.0625	31.000 1.2205	3.5 .14	.96 kg 2.11 lb							
<b>43000 Series</b>											
43096	24.384 .9600	24.074 .9478	.8 .03	.43 kg .94 lb	43300	76.200 3.0000	16.670 .6563	3.3 .13	.15 kg .32 lb	24.608 .9688	43112: SPECIAL BACKFACE RADIUS
*43112	28.575 1.1250	24.074 .9478	.8 .03	.39 kg .87 lb	*43312-B	79.375 3.1250	17.462 .6875	1.5 .06	.25 kg .55 lb	13.495 .5313	43117: BROKEN FRONTFACE ID SPECIAL BACKFACE RADIUS
*43117	29.987 1.1806	24.074 .9478	1.5 .06	.38 kg .84 lb	43312	79.375 3.1250	17.462 .6875	1.5 .06	.22 kg .48 lb	25.400 1.0000	43118: BROKEN FRONTFACE ID SPECIAL BACKFACE RADIUS
*43118	30.162 1.1875	24.074 .9478	1.5 .06	.38 kg .84 lb	43315	80.167 3.1562	23.812 .9375	2.3 .09	.28 kg .61 lb	26.988 1.0625	43125: BROKEN FRONTFACE ID SPECIAL BACKFACE RADIUS
*43125	31.750 1.2500	24.074 .9478	1.5 .06	.36 kg .80 lb	*43319DC	80.962 3.1875	39.688 1.5625	1.5 .06	.55 kg 1.21 lb	55.563 2.1875	
*43131	33.338 1.3125	24.074 .9478	3.5 .14	.34 kg .76 lb	*43319D	80.962 3.1875	39.688 1.5625	1.5 .06	.55 kg 1.21 lb	55.563 2.1875	43131: BROKEN FRONTFACE ID SPECIAL BACKFACE RADIUS
*43131W	33.338 1.3125	24.074 .9478	3.5 .14	.34 kg .76 lb	43326	82.550 3.2500	17.462 .6875	1.5 .06	.27 kg .60 lb	25.400 1.0000	43131W: BROKEN FRONTFACE ID SPECIAL BACKFACE RADIUS
*43132	33.338 1.3125	24.074 .9478	2.0 .08	.35 kg .77 lb							
*43137X	34.925 1.3750	24.074 .9478	3.5 .14	.33 kg .72 lb							NA43131: BROKEN FRONTFACE ID SPECIAL BACKFACE RADIUS
*NA43131	33.338 1.3125	27.783 1.0938	2.3 .09	- -	*43319DC	80.962 3.1875	39.688 1.5625	1.5 .06	.55 kg 1.21 lb	55.565 2.1876	43132: BROKEN FRONTFACE ID SPECIAL BACKFACE RADIUS
					*43319D	80.962 3.1875	39.688 1.5625	1.5 .06	.55 kg 1.21 lb	55.565 2.1876	43137X: BROKEN FRONTFACE ID SPECIAL BACKFACE RADIUS
											43138X: BROKEN FRONTFACE ID SPECIAL BACKFACE RADIUS
											43312-B : FLANGE ON OD FRONTFACE, BEARING WIDTH IS T1 DIMENSION
											43319D : GROOVE IN OD CENTER HOLES IN OD CENTER
											43319DC : HOLES IN OD CENTER
*43138X	35.000 1.3780	23.282 .9166	3.5 .14	.32 kg .70 lb	43138X may be paired with all single cups corresponding to 43096 and will require -.792 mm (-.0312 in) to be added to the T-width values. 43138X may be paired with all double cups corresponding to 43096 and will require -1.585 mm (-.0624 in) to be added to the T-width values.						
<b>44000 Series</b>											
44126	31.750 1.2500	23.698 .9330	1.5 .06	.54 kg 1.19 lb	*44348-B	88.500 3.4843	17.462 .6875	1.5 .06	.28 kg .61 lb	13.493 .5312	44348-B : FLANGE ON OD FRONTFACE, BEARING WIDTH IS T1 DIMENSION
44131	33.338 1.3125	23.698 .9330	2.0 .08	.52 kg 1.15 lb	44348	88.500 3.4843	17.462 .6875	1.5 .06	.24 kg .53 lb	25.400 1.0000	44348D : GROOVE IN OD CENTER HOLES IN OD CENTER
44143	36.512 1.4375	23.698 .9330	2.3 .09	.49 kg 1.08 lb	*44348D	88.500 3.4843	39.688 1.5625	.6 .02	.53 kg 1.16 lb	55.563 2.1875	44363D : GROOVE IN OD CENTER HOLES IN OD CENTER
44143W	36.512 1.4375	23.698 .9330	2.3 .09	.48 kg 1.06 lb	44354	89.992 3.5430	17.462 .6875	1.5 .06	.27 kg .60 lb	25.400 1.0000	

\*\*These Maximum Fillet Radii will be cleared by the Cone or Cup Radii.  
†Bore or O.D. shown are maximum dimensions. \*See Remarks Column.

44000 – 45200 SERIES

5

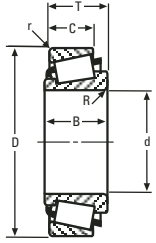

SINGLE ROW



SINGLE ROW WITH FLANGE

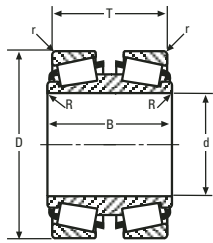

DOUBLE CONE

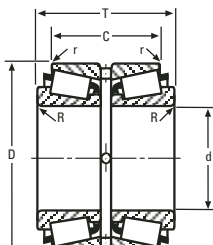

DOUBLE CUP

CONE			Max Shaft Fillet Radii R <sup>**</sup>	Weight	CUP			Max Hs'ng Fillet Radii r <sup>**</sup>	Weight	BEARING	Remarks
Number	BORE d	WIDTH B			Number	OUTSIDE DIA D	WIDTH C			WIDTH T	
<b>44000 Series (cont)</b>											
44150	38.100 1.5000	23.698 .9330	2.3 .09	.47 kg 1.04 lb	*44363D	92.075 3.6250	39.688 1.5625	1.5 .06	.70 kg 1.55 lb	55.563 2.1875	
44156	39.688 1.5625	23.698 .9330	2.3 .09	.45 kg 1.00 lb							
44157	40.000 1.5748	23.698 .9330	2.3 .09	.45 kg .99 lb							
44158	39.688 1.5625	23.698 .9330	3.5 .14	.45 kg .99 lb							
44162	41.275 1.6250	23.698 .9330	2.3 .09	.44 kg .96 lb							
NA44143	36.512 1.4375	27.783 1.0938	.8 .03	- -	*44348D	88.500 3.4843	39.688 1.5625	.6 .02	.53 kg 1.16 lb	55.565 2.1876	
NA44156	39.688 1.5625	27.783 1.0938	2.3 .09	- -	*44363D	92.075 3.6250	39.688 1.5625	1.5 .06	.70 kg 1.55 lb	55.565 2.1876	
NA44163	41.275 1.6250	27.783 1.0938	.8 .03	- -							
44157X	40.000 1.5748	23.063 .9080	2.3 .09	.44 kg .98 lb	44157X may be paired with all single cups corresponding to 44126 and will require -.635 mm (-.0250 in) to be added to the T-width values. 44157X may be paired with all double cups corresponding to 44126 and will require -1.270 mm (-.0500 in) to be added to the T-width values.						
<b>L44600 Series</b>											
L44640	23.812 .9375	14.732 .5800	1.5 .06	.09 kg .21 lb	L44610-Z	50.292 1.9800	10.668 4.200	1.3 .05	.04 kg .08 lb	14.224 .5600	L44643X: GROOVE IN ID BACKFACE
†JL44642A	25.000 .9843	14.732 .5800	1.3 .05	.09 kg .20 lb	L44610	50.292 1.9800	10.668 4.200	1.3 .05	.04 kg .08 lb	14.224 .5600	
L44642	25.400 1.0000	14.732 .5800	3.5 .14	.08 kg .18 lb	L44613	51.986 2.0467	12.700 5.000	2.0 .08	.06 kg .12 lb	15.011 .5910	
L44643	25.400 1.0000	14.732 .5800	1.3 .05	.09 kg .19 lb	†JL44615	52.000 2.0472	10.668 4.200	1.3 .05	.05 kg .11 lb	14.224 .5600	
L44643H	25.400 1.0000	14.732 .5800	1.3 .05	- -							
*L44643X	25.400 1.0000	14.732 .5800	1.3 .05	.09 kg .19 lb							
L44645	25.987 1.0231	14.732 .5800	3.5 .14	.08 kg .18 lb							
L44649	26.988 1.0625	14.732 .5800	3.5 .14	.08 kg .17 lb							
L44649-Z	26.988 1.0625	14.732 .5800	3.5 .14	.08 kg .17 lb							
L44649F	26.988 1.0625	14.732 .5800	3.5 .14	- -							
L44649H	26.988 1.0625	14.732 .5800	3.5 .14	.08 kg .17 lb							
<b>45200 Series</b>											
45280	44.450 1.7500	30.958 1.2188	.8 .03	1.00 kg 2.20 lb	*45220-B	104.775 4.1250	23.812 .9375	3.3 .13	.39 kg .85 lb	11.907 .4688	45220-B : FLANGE ON OD FRONTFACE, BEARING WIDTH IS T1 DIMENSION
45282	47.625 1.8750	30.958 1.2188	3.5 .14	.94 kg 2.07 lb	45220	104.775 4.1250	23.812 .9375	3.3 .13	.35 kg .76 lb	30.162 1.1875	
45284	50.800 2.0000	30.958 1.2188	6.4 .25	.86 kg 1.89 lb	45221	104.775 4.1250	23.812 .9375	.8 .03	.35 kg .77 lb	30.162 1.1875	
45285	50.800 2.0000	30.958 1.2188	2.3 .09	.89 kg 1.95 lb	45222	106.362 4.1875	23.812 .9375	3.3 .13	.39 kg .85 lb	30.162 1.1875	
45285A	50.800 2.0000	30.958 1.2188	.8 .03	.88 kg 1.95 lb							
45287	53.975 2.1250	30.958 1.2188	.8 .03	.82 kg 1.81 lb							
45289	57.150 2.2500	30.958 1.2188	.8 .03	.75 kg 1.66 lb							
45290	57.150 2.2500	30.958 1.2188	2.3 .09	.75 kg 1.66 lb							
45290CA	57.150 2.2500	30.958 1.2188	2.3 .09	.75 kg 1.66 lb							
45291	57.150 2.2500	30.958 1.2188	6.4 .25	.72 kg 1.60 lb							

L45400 SERIES CONTINUED ON NEXT PAGE

\*\*These Maximum Fillet Radii will be cleared by the Cone or Cup Radii.  
†Bore or O.D. shown are maximum dimensions. \*See Remarks Column.

L45400 – 46700 SERIES

5

CONE			Max Shaft Fillet Radii R <sup>**</sup>	Weight	CUP			Max Hs'ng Fillet Radii r <sup>**</sup>	Weight	BEAR-ING	Remarks
Number	BORE d	WIDTH B			Number	OUTSIDE DIA D	WIDTH C			WIDTH T	
<b>L45400 Series</b>											
L45449	29.000 1.1417	14.732 .5800	3.5 .14	.08 kg .17 lb	*L45410-Z	50.292 1.9800	10.668 .4200	1.3 .05	.03 kg .08 lb	14.224 .5600	L45410 : CHAMFER ON FRONTFACE OD
L45449F	29.000 1.1417	14.732 .5800	3.5 .14	- -	*L45410	50.292 1.9800	10.668 .4200	1.3 .05	.03 kg .08 lb	14.224 .5600	L45410-Z : CHAMFER ON FRONTFACE OD
<b>46000 Series</b>											
46143	36.512 1.4375	31.750 1.2500	1.5 .06	.75 kg 1.65 lb	46368	93.662 3.6875	26.195 1.0313	3.3 .13	.40 kg .88 lb	31.750 1.2500	
46150	38.100 1.5000	31.750 1.2500	.8 .03	.73 kg 1.60 lb	46369	93.662 3.6875	26.195 1.0313	1.3 .05	.41 kg .90 lb	31.750 1.2500	
46151	38.100 1.5000	31.750 1.2500	3.5 .14	.72 kg 1.59 lb							
46162	41.275 1.6250	31.750 1.2500	.8 .03	.68 kg 1.49 lb							
46175	44.450 1.7500	31.750 1.2500	.8 .03	.62 kg 1.38 lb							
46176	44.450 1.7500	31.750 1.2500	3.5 .14	.62 kg 1.36 lb							
<b>46700 Series</b>											
*46780	158.750 6.2500	39.688 1.5625	3.5 .14	- -	46720	225.425 8.8750	33.338 1.3125	3.3 .13	1.63 kg 3.59 lb	41.275 1.6250	46777T: REVERSE TAPERED BORE
*46790	165.100 6.5000	39.688 1.5625	3.5 .14	- -	*46720-B	225.425 8.8750	33.338 1.3125	3.3 .13	1.66 kg 3.67 lb	13.495 .5313	46780: FRONTFACE CHAMFER 46780TD: TAPERED BORE
*46790A	165.100 6.5000	39.688 1.5625	spcl. spcl.	- -	*46720CD	225.425 8.8750	69.850 2.7500	.8 .03	3.49 kg 7.70 lb	85.725 3.3750	46790: FRONTFACE CHAMFER
*46791A	166.000 6.5354	39.688 1.5625	3.5 .14	- -	*46720DV	225.425 8.8750	69.850 2.7500	.8 .03	3.49 kg 7.70 lb	85.725 3.3750	46790A: BROKEN FRONTFACE ID
*46792	166.688 6.5625	39.688 1.5625	spcl. spcl.	- -	*46720DW	225.425 8.8750	69.850 2.7500	.8 .03	- -	85.725 3.3750	SPECIAL BACKFACE RADIUS
					*46721D	225.425 8.8750	76.200 3.0000	.8 .03	4.15 kg 9.14 lb	92.075 3.6250	NA46790: BROKEN FRONTFACE ID SPECIAL BACKFACE RADIUS
					46721XD	225.425 8.8750	76.200 3.0000	.8 .03	- -	92.075 3.6250	NA46790-SW: FRONTFACE CHAMFER SLOTS IN FRONTFACE
*46780TD	158.750 6.2500	76.200 3.0000	spcl. spcl.	8.96 kg 19.76 lb	46720	225.425 8.8750	33.338 1.3125	3.3 .13	1.63 kg 3.59 lb	79.375 3.1250	NA46790-SVV: EXTENDED LARGE RIB FRONTFACE CHAMFER MADE FROM VACUUM MELT STEEL SLOTS IN FRONTFACE SPECIAL BACKFACE RADIUS
46790D	165.100 6.5000	76.200 3.0000	spcl. spcl.	7.53 kg 16.60 lb							
*46791D	165.100 6.5000	79.375 3.1250	spcl. spcl.	7.58 kg 16.72 lb							
*46791DW	165.100 6.5000	79.375 3.1250	spcl. spcl.	7.58 kg 16.72 lb							46791A: BROKEN FRONTFACE ID  46791D: ASYMMETRICAL BEARING SHOULDER ON OD RIGHTFACE 46791DW: ASYMMETRICAL BEARING SHOULDER ON OD RIGHTFACE SLOTS IN LEFTFACE NA46791: BROKEN FRONTFACE ID EXTENDED LARGE RIB SPECIAL BACKFACE RADIUS 46792: BROKEN FRONTFACE ID SPECIAL BACKFACE RADIUS 46792TD: REVERSE TAPERED BORE 46799T: TAPERED BORE 46799TE: EXTENDED LARGE RIB SPECIAL BACKFACE RADIUS SPECIAL FRONTFACE RADIUS TAPERED BORE 46720-B : FLANGE ON OD FRONTFACE, BEARING WIDTH IS T1 DIMENSION 46720CD : GROOVE IN OD CENTER HOLES IN OD CENTER

\*\*These Maximum Fillet Radii will be cleared by the Cone or Cup Radii.  
†Bore or O.D. shown are maximum dimensions. \*See Remarks Column.

46700 SERIES CONTINUED ON NEXT PAGE

46700 – 47600 SERIES

5

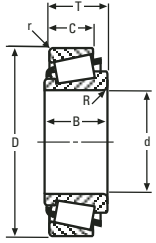

SINGLE ROW



SINGLE ROW WITH FLANGE

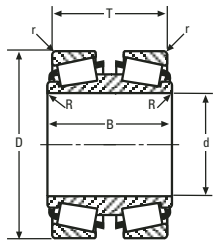

DOUBLE CONE

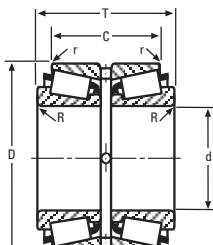

DOUBLE CUP

CONE			Max Shaft Fillet Radii R <sup>**</sup>	Weight	CUP			Max Hs'ng Fillet Radii r <sup>**</sup>	Weight	BEARING	Remarks
Number	BORE d	WIDTH B			WIDTH T						
<b>46700 Series (cont)</b>											
*46777T	160.205 6.3073	42.862 1.6875	3.3 .13	-	46720	225.425 8.8750	33.338 1.3125	3.3 .13	1.63 kg 3.59 lb	40.970 1.6130	46720DV : GROOVE IN OD CENTER HOLES IN OD CENTER MADE FROM VACUUM MELT STEEL
*46799T	170.655 6.7187	42.862 1.6875	3.0 .12	-	*46720-B	225.425 8.8750	33.338 1.3125	3.3 .13	1.66 kg 3.67 lb	13.190 .5193	46720DW : GROOVE IN OD CENTER HOLES IN OD CENTER KEYWAY IN OD CENTER
					*46721D	225.425 8.8750	76.200 3.0000	.8 .03	4.15 kg 9.14 lb	91.465 3.6010	46721D : GROOVE IN OD CENTER HOLES IN OD CENTER
					46721XD	225.425 8.8750	76.200 3.0000	.8 .03	-	91.465 3.6010	
*NA46790	165.100 6.5000	47.625 1.8750	spcl. spcl.	-	*46720CD	225.425 8.8750	69.850 2.7500	.8 .03	3.49 kg 7.70 lb	95.250 3.7500	
*NA46790-SW	165.100 6.5000	47.625 1.8750	3.5 .14	-	*46720DV	225.425 8.8750	69.850 2.7500	.8 .03	3.49 kg 7.70 lb	95.250 3.7500	
*NA46790-SWV	165.100 6.5000	47.625 1.8750	spcl. spcl.	-	*46720DW	225.425 8.8750	69.850 2.7500	.8 .03	-	95.250 3.7500	
*NA46791	165.496 6.5156	47.625 1.8750	spcl. spcl.	-	*46721D	225.425 8.8750	76.200 3.0000	.8 .03	4.15 kg 9.14 lb	95.250 3.7500	
					46721XD	225.425 8.8750	76.200 3.0000	.8 .03	-	95.250 3.7500	
*46792TD	167.084 6.5781	82.550 3.2500	spcl. spcl.	8.20 kg 18.09 lb	46792TD may be paired with all single cups corresponding to 46780TD and will require -.610 mm (-.0240 in) to be added to the T-width values.						
*46799TE	173.698 6.8385	79.375 3.1250	spcl. spcl.	-	46799TE may be paired with all single cups corresponding to 46777T and will require 36.512 mm (1.4375 in) to be added to the T-width values.						
					46799TE may be paired with all double cups corresponding to 46777T and will require 73.025 mm (2.8750 in) to be added to the T-width values.						
<b>47400 Series</b>											
47487	69.850 2.7500	32.545 1.2813	3.5 .14	.99 kg 2.17 lb	47420	120.000 4.7244	26.195 1.0313	3.3 .13	.47 kg 1.04 lb	32.545 1.2813	47420D : GROOVE IN OD CENTER HOLES IN OD CENTER
47490	71.438 2.8125	32.545 1.2813	3.5 .14	.94 kg 2.07 lb	47420A	120.000 4.7244	26.195 1.0313	.5 .02	.49 kg 1.07 lb	32.545 1.2813	47420DC : HOLES IN OD CENTER
					*47420D	120.000 4.7244	58.738 2.3125	.8 .03	1.09 kg 2.41 lb	71.437 2.8125	
					*47420DC	120.000 4.7244	58.738 2.3125	.8 .03	1.09 kg 2.41 lb	71.437 2.8125	
					tJ47420X	120.000 4.7244	26.195 1.0313	.8 .03	.47 kg 1.04 lb	32.545 1.2813	
					47423	120.650 4.7500	26.195 1.0313	.8 .03	.51 kg 1.12 lb	32.545 1.2813	
<b>47600 Series</b>											
47675	71.438 2.8125	33.338 1.3125	3.5 .14	1.48 kg 3.27 lb	47620	133.350 5.2500	26.195 1.0313	3.3 .13	.56 kg 1.24 lb	33.337 1.3125	47620-B : FLANGE ON OD FRONTFACE, BEARING WIDTH IS T1 DIMENSION
47678	76.200 3.0000	33.338 1.3125	6.4 .25	1.31 kg 2.89 lb	47620A	133.350 5.2500	26.195 1.0313	.8 .03	.58 kg 1.28 lb	33.337 1.3125	47622-BW : FLANGE ON OD FRONTFACE, BEARING WIDTH IS T1 DIMENSION KEYWAY IN OD SURFACE
47679	76.200 3.0000	33.338 1.3125	3.5 .14	1.34 kg 2.95 lb	*47620-B	133.350 5.2500	26.195 1.0313	3.3 .13	.72 kg 1.58 lb	12.700 .5000	
47679W	76.200 3.0000	33.338 1.3125	3.5 .14	1.37 kg 3.03 lb	47621	139.992 5.5115	29.370 1.1563	3.3 .13	.99 kg 2.19 lb	36.512 1.4375	47622W : KEYWAY IN OD SURFACE THREADED OD FRONTFACE
47680	76.200 3.0000	33.338 1.3125	.8 .03	1.35 kg 2.98 lb	*47622-BW	136.525 5.3750	51.595 2.0313	3.3 .13	1.84 kg 4.05 lb	12.304 .4844	47623A : CHAMFER ON BACKFACE OD THREADED OD FRONTFACE
47681	80.962 3.1875	33.338 1.3125	3.5 .14	1.19 kg 2.61 lb	*47622W	136.525 5.3750	55.562 2.1875	3.3 .13	1.81 kg 4.00 lb	55.562 2.1875	47623AB : CHAMFER ON BACKFACE OD CHAMFER ON FRONTFACE OD FLANGE ON OD FRONTFACE, BEARING WIDTH IS T1 DIMENSION
47685	82.550 3.2500	33.338 1.3125	.8 .03	1.14 kg 2.52 lb	*47623A	136.525 5.3750	44.450 1.7500	-	1.24 kg 2.74 lb	44.450 1.7500	
47686	82.550 3.2500	33.338 1.3125	3.5 .14	1.13 kg 2.50 lb	*47623AB	136.525 5.3750	38.100 1.5000	-	1.32 kg 2.91 lb	12.319 .4850	
47687	82.550 3.2500	33.338 1.3125	6.8 .27	1.10 kg 2.42 lb							
47688	83.345 3.2813	33.338 1.3125	3.5 .14	1.11 kg 2.44 lb							

47800 SERIES CONTINUED ON NEXT PAGE

\*\*These Maximum Fillet Radii will be cleared by the Cone or Cup Radii.  
†Bore or O.D. shown are maximum dimensions. \*See Remarks Column.

47800 – 48200 SERIES

5

CONE			Max Shaft Fillet Radii R''	Weight	CUP			Max Hs'ng Fillet Radii r''	Weight	BEAR-ING	Remarks	
Number	BORE d	WIDTH B			Number	OUTSIDE DIA D	WIDTH C			T		
<b>47800 Series</b>												
47880	77.788 3.0625	34.925 1.3750	3.5 .14	1.92 kg 4.23 lb	47820	146.050 5.7500	26.195 1.0313	3.3 .13	.65 kg 1.43 lb	33.337 1.3125	47890XX: MADE FROM VACUUM MELT STEEL	
47890	92.075 3.6250	34.925 1.3750	3.5 .14	1.41 kg 3.10 lb	*47820XX	146.050 5.7500	26.195 1.0313	3.3 .13	.65 kg 1.43 lb	33.337 1.3125	7896WVC: MADE FROM VACUUM MELT STEEL	
*47890XX	92.075 3.6250	34.925 1.3750	3.5 .14	1.41 kg 3.10 lb	*47822-B	146.050 5.7500	26.195 1.0313	1.5 .06	.77 kg 1.69 lb	15.080 .5937	47820XX: MADE FROM VACUUM MELT STEEL	
47896	95.250 3.7500	34.925 1.3750	3.5 .14	1.28 kg 2.82 lb	47823	151.130 5.9500	26.195 1.0313	3.3 .13	.89 kg 1.97 lb	33.337 1.3125	47822-B: FLANGE ON OD FRONTFACE, BEARING WIDTH IS T1 DIMENSION	
47896W	95.250 3.7500	34.925 1.3750	3.5 .14	1.27 kg 2.81 lb	*47825-B	142.875 5.6250	26.195 1.0313	1.5 .06	.60 kg 1.32 lb	15.080 .5937	47825-B: FLANGE ON OD FRONTFACE, BEARING WIDTH IS T1 DIMENSION	
*47896WVC	95.250 3.7500	34.925 1.3750	3.5 .14	1.29 kg 2.84 lb								
47898	95.250 3.7500	34.925 1.3750	7.0 .28	1.22 kg 2.69 lb								
<b>48000 Series</b>												
48506	128.587 5.0625	31.750 1.2500	3.5 .14	1.89 kg 4.16 lb	*48750-B	190.500 7.5000	25.400 1.0000	3.3 .13	1.31 kg 2.89 lb	15.875 .6250	48750-B: FLANGE ON OD FRONTFACE, BEARING WIDTH IS T1 DIMENSION	
					48750	190.500 7.5000	25.400 1.0000	3.3 .13	1.21 kg 2.67 lb	34.925 1.3750		
<b>48100 Series</b>												
48190	107.950 4.2500	34.925 1.3750	3.5 .14	1.53 kg 3.37 lb	48120	161.925 6.3750	26.988 1.0625	3.3 .13	.81 kg 1.79 lb	34.925 1.3750		
<b>48200 Series</b>												
48282	120.650 4.7500	38.100 1.5000	3.5 .14	2.55 kg 5.62 lb	48220	182.562 7.1875	33.338 1.3125	3.3 .13	1.12 kg 2.47 lb	39.689 1.5626	48290D: ASYMMETRICAL BEARING SHOULDER ON OD RIGHTFACE	
48286	123.825 4.8750	38.100 1.5000	3.5 .14	2.37 kg 5.22 lb	*48220-B	182.562 7.1875	33.338 1.3125	3.3 .13	1.29 kg 2.84 lb	12.700 .5000	48290DW: ASYMMETRICAL BEARING SHOULDER ON OD LEFTFACE SLOTS IN RIGHTFACE	
48290	127.000 5.0000	38.100 1.5000	3.5 .14	2.18 kg 4.81 lb	*48220D	182.562 7.1875	73.025 2.8750	.8 .03	2.63 kg 5.80 lb	85.728 3.3751		
48290W	127.000 5.0000	38.100 1.5000	3.5 .14	2.15 kg 4.75 lb	*48220DC	182.562 7.1875	73.025 2.8750	.8 .03	2.63 kg 5.80 lb	85.728 3.3751	48290TD: ASYMMETRICAL BEARING REVERSE TAPERED BORE SHOULDER ON OD LEFTFACE	
*48290D	127.000 5.0000	76.200 3.0000	1.5 .06	5.37 kg 11.84 lb	48220	182.562 7.1875	33.338 1.3125	3.3 .13	1.12 kg 2.47 lb	76.200 3.0000	NA48290-SW: EXTENDED LARGE RIB FRONTFACE CHAMFER SLOTS IN FRONTFACE	
*48290DW	127.000 5.0000	76.200 3.0000	1.5 .06	5.35 kg 11.81 lb								
*48290TD	127.000 5.0000	76.200 3.0000	1.6 .06	5.74 kg 12.66 lb							48220-B: FLANGE ON OD FRONTFACE- BEARING WIDTH IS T1 DIMENSION	
											48220D: GROOVE IN OD CENTER HOLES IN OD CENTER	
NA48291	127.000 5.0000	42.862 1.6875	3.5 .14	4.58 kg 10.11 lb	*48220D	182.562 7.1875	73.025 2.8750	.8 .03	2.63 kg 5.80 lb	85.725 3.3750	48220DC: GROOVE IN OD CENTER HOLES IN OD CENTER	
					*48220DC	182.562 7.1875	73.025 2.8750	.8 .03	2.63 kg 5.80 lb	85.725 3.3750		
					*K103649	355.600 14.0000	157.162 6.1875	6.4 .25	93.49 kg 206.14 lb	85.725 3.3750	K103649: ASYMMETRICAL BEARING FLANGE ON OD LEFTFACE	
					*K109413	304.800 12.0000	157.162 6.1875	6.4 .25	64.77 kg 142.82 lb	85.725 3.3750	K109413: ASYMMETRICAL BEARING FLANGE ON OD LEFTFACE	
					*K302670	304.800 12.0000	157.162 6.1875	6.4 .25	65.66 kg 144.79 lb	85.725 3.3750		
					K326053	330.200 13.0000	127.000 5.0000	6.4 .25	60.11 kg 132.55 lb	85.725 3.3750	K302670: ASYMMETRICAL BEARING FLANGE ON OD LEFTFACE	
*NA48290-SW	127.000 5.0000	46.830 1.8437	3.5 .14	5.10 kg 11.24 lb	NA48290-SW may be paired with all double cups corresponding to NA48291 and will require 7.935 mm (.3124 in) to be added to the T-width values.							

\*\*These Maximum Fillet Radii will be cleared by the Cone or Cup Radii.  
†Bore or O.D. shown are maximum dimensions. \*See Remarks Column.

48300 – 48600 SERIES

5

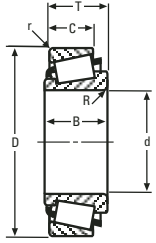

SINGLE ROW



SINGLE ROW WITH FLANGE

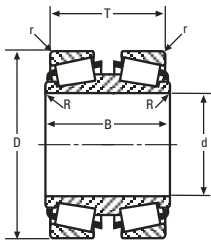

DOUBLE CONE

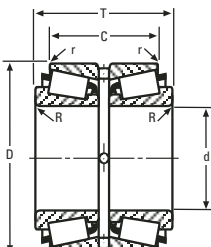

DOUBLE CUP

CONE			Max Shaft Fillet Radii R <sup>**</sup>	Weight	CUP			Max Hs'ng Fillet Radii r <sup>**</sup>	Weight	BEAR-ING	Remarks
Number	BORE d	WIDTH B			Number	OUTSIDE DIA D	WIDTH C			WIDTH T	
<b>48300 Series</b>											
*48381DE	127.000 5.0000	166.688 6.5625	.8 .03	10.15 kg 22.39 lb	48320	190.500 7.5000	33.338 1.3125	3.3 .13	1.14 kg 2.51 lb	76.995 3.0313	48381DE: EXTENDED SMALL RIB 48320-B: FLANGE ON OD FRONTFACE, BEARING WIDTH IS T1 DIMENSION
					48328	203.200 8.0000	33.338 1.3125	3.3 .13	2.16 kg 4.76 lb	76.995 3.0313	48320D: GROOVE IN OD CENTER HOLES IN OD CENTER
48385	133.350 5.2500	39.688 1.5625	3.5 .14	2.42 kg 5.34 lb	48320	190.500 7.5000	33.338 1.3125	3.3 .13	1.14 kg 2.51 lb	39.687 1.5625	48320DC: HOLES IN OD CENTER
48393	136.525 5.3750	39.688 1.5625	3.5 .14	2.21 kg 4.88 lb	*48320-B	190.500 7.5000	33.338 1.3125	3.3 .13	1.18 kg 2.60 lb	11.908 .4688	
48393A	136.525 5.3750	39.688 1.5625	5.5 .22	2.24 kg 4.93 lb	*48320D	190.500 7.5000	73.025 2.8750	.8 .03	2.48 kg 5.46 lb	85.725 3.3750	
					*48320DC	190.500 7.5000	73.025 2.8750	.8 .03	2.48 kg 5.46 lb	85.725 3.3750	
					48328	203.200 8.0000	33.338 1.3125	3.3 .13	2.16 kg 4.76 lb	39.687 1.5625	
NA48385	133.350 5.2500	42.862 1.6875	3.5 .14	5.02 kg 11.07 lb	*48320D	190.500 7.5000	73.025 2.8750	.8 .03	2.48 kg 5.46 lb	85.725 3.3750	
NA48390	136.525 5.3750	42.862 1.6875	3.5 .14	4.57 kg 10.07 lb	*48320DC	190.500 7.5000	73.025 2.8750	.8 .03	2.48 kg 5.46 lb	85.725 3.3750	
48393D	136.525 5.3750	77.788 3.0625	1.5 .06	5.53 kg 12.20 lb	48393D may be paired with all single cups corresponding to 48381DE and will require .792 mm (.0312 in) to be added to the T-width values.						
<b>LM48500 Series</b>											
*LM48534-SD	35.052 1.3800	66.675 2.6250	spcl. spcl.	.69 kg 1.53 lb	LM48510	65.088 2.5625	13.970 .5500	1.3 .05	.09 kg .19 lb	38.100 1.5000	LM48534-SD: EXTENDED SMALL RIB SQUARE BORE
					LM48510P	65.088 2.5625	13.970 .5500	1.3 .05	.09 kg .19 lb	38.100 1.5000	LM48548: SPECIAL BACKFACE RADIUS
					LM48511	65.088 2.5625	16.256 .6400	1.3 .05	.11 kg .23 lb	42.672 1.6800	LM48548C: SPECIAL BACKFACE RADIUS
					LM48511A	65.088 2.5625	17.018 .6700	1.5 .06	.11 kg .25 lb	44.196 1.7400	LM48548P: SPECIAL BACKFACE RADIUS
					LM48514	68.262 2.6875	13.970 .5500	1.3 .05	.12 kg .27 lb	38.100 1.5000	LM48510-B: FLANGE ON OD FRONTFACE, BEARING WIDTH IS T1 DIMENSION
					*LM48514XP	68.262 2.6875	13.970 .5500	1.3 .05	.12 kg .27 lb	38.100 1.5000	LM48514XP: GROOVE IN OD CENTER
LM48545	35.128 1.3830	18.288 .7200	.8 .03	.17 kg .36 lb	LM48510	65.088 2.5625	13.970 .5500	1.3 .05	.09 kg .19 lb	18.034 .7100	
*LM48548	34.925 1.3750	18.288 .7200	spcl. spcl.	.16 kg .35 lb	*LM48510-B	65.088 2.5625	13.970 .5500	1.3 .05	.09 kg .20 lb	7.239 .2850	
LM48548A	34.925 1.3750	18.288 .7200	.8 .03	.16 kg .36 lb	LM48510P	65.088 2.5625	13.970 .5500	1.3 .05	.09 kg .19 lb	18.034 .7100	
*LM48548C	34.925 1.3750	18.288 .7200	spcl. spcl.	.16 kg .35 lb	LM48511	65.088 2.5625	16.256 .6400	1.3 .05	.11 kg .23 lb	20.320 .8000	
*LM48548P	34.925 1.3750	18.288 .7200	spcl. spcl.	.16 kg .35 lb	LM48511A	65.088 2.5625	17.018 .6700	1.5 .06	.11 kg .25 lb	21.082 .8300	
LM48549	34.925 1.3750	18.288 .7200	1.5 .06	.17 kg .37 lb	LM48514	68.262 2.6875	13.970 .5500	1.3 .05	.12 kg .27 lb	18.034 .7100	
LM48549X	34.925 1.3750	18.288 .7200	2.3 .09	.16 kg .36 lb	*LM48514XP	68.262 2.6875	13.970 .5500	1.3 .05	.12 kg .27 lb	18.034 .7100	
<b>48600 Series</b>											
*48680D	139.700 5.5000	75.408 2.9688	.8 .03	6.54 kg 14.42 lb	48620	200.025 7.8750	34.130 1.3437	3.3 .13	1.37 kg 3.01 lb	77.788 3.0625	48680D: ASYMMETRICAL BEARING SHOULDER ON OD LEFTFACE
*48680DGW	139.700 5.5000	75.408 2.9688	.8 .03	6.52 kg 14.37 lb	*48620XX	200.025 7.8750	34.130 1.3437	3.3 .13	1.37 kg 3.01 lb	77.788 3.0625	48680DGW: GROOVE IN ID SHOULDER ON OD LEFTFACE SLOTS IN RIGHTFACE
*48685TD	142.875 5.6250	74.612 2.9375	.8 .03	6.43 kg 14.18 lb							48685TD: TAPERED BORE
48684	142.875 5.6250	39.688 1.5625	7.9 .31	2.38 kg 5.24 lb	AAAG291	200.000 7.8740	73.025 2.8750	.8 .03	2.87 kg 6.33 lb	87.315 3.4376	48685XX: MADE FROM VACUUM MELT STEEL
48685	142.875 5.6250	39.688 1.5625	3.5 .14	2.47 kg 5.45 lb	48620	200.025 7.8750	34.130 1.3437	3.3 .13	1.37 kg 3.01 lb	41.275 1.6250	NA48685-SW: FRONTFACE CHAMFER SLOTS IN FRONTFACE
48685W	142.875 5.6250	39.688 1.5625	3.5 .14	2.53 kg 5.58 lb	*48620-B	200.025 7.8750	34.130 1.3437	3.3 .13	1.38 kg 3.05 lb	12.700 .5000	

48600 SERIES CONTINUED ON NEXT PAGE

\*\*These Maximum Fillet Radii will be cleared by the Cone or Cup Radii.  
†Bore or O.D. shown are maximum dimensions. \*See Remarks Column.





CONE			Max Shaft Fillet Radii R <sup>**</sup>	Weight	CUP			Max Hs'ng Fillet Radii r <sup>**</sup>	Weight	BEARING WIDTH T	Remarks
Number	BORE d	WIDTH B			Number	OUTSIDE DIA D	WIDTH C				
<b>48600 Series (cont)</b>											
*48685XX	142.875 5.6250	39.688 1.5625	3.5 .14	2.48 kg 5.46 lb	*48620D	200.025 7.8750	73.025 2.8750	.8 .03	2.85 kg 6.29 lb	87.315 3.4376	48620-B : FLANGE ON OD FRONTFACE, BEARING WIDTH IS T1 DIMENSION
48686	142.875 5.6250	42.862 1.6875	3.5 .14	2.61 kg 5.75 lb	*48620DC	200.025 7.8750	73.025 2.8750	.8 .03	2.85 kg 6.29 lb	87.315 3.4376	48620D : GROOVE IN OD CENTER? HOLES IN OD CENTER
					*48620XX	200.025 7.8750	34.130 1.3437	3.3 .13	1.37 kg 3.01 lb	41.275 1.6250	48620DC : HOLES IN OD CENTER 48620XX : MADE FROM VACUUM MELT STEEL
AAAG289	140.000 5.5118	46.833 1.8438	3.5 .14	2.98 kg 6.56 lb	48620	200.025 7.8750	34.130 1.3437	3.3 .13	1.37 kg 3.01 lb	44.400 1.7480	
					*48620-B	200.025 7.8750	34.130 1.3437	3.3 .13	1.38 kg 3.05 lb	15.824 .6230	
					*48620XX	200.025 7.8750	34.130 1.3437	3.3 .13	1.37 kg 3.01 lb	44.400 1.7480	
*NA48685-SW	142.875 5.6250	46.833 1.8438	3.5 .14	5.53 kg 12.20 lb	AAAG291	200.000 7.8740	73.025 2.8750	.8 .03	2.87 kg 6.33 lb	93.665 3.6876	
NA48686	142.875 5.6250	46.833 1.8438	3.5 .14	5.52 kg 12.18 lb	*48620D	200.025 7.8750	73.025 2.8750	.8 .03	2.85 kg 6.29 lb	93.665 3.6876	
					*48620DC	200.025 7.8750	73.025 2.8750	.8 .03	2.85 kg 6.29 lb	93.665 3.6876	
<b>48900 Series</b>											
*NA48990-SW	152.400 6.0000	46.038 1.8125	3.5 .14	- -	*48920D	211.138 8.3125	69.850 2.7500	.8 .03	3.07 kg 6.78 lb	92.075 3.6250	NA48990-SW: EXTENDED LARGE RIB FRONTFACE CHAMFER SLOTS IN FRONTFACE 48920D : GROOVE IN OD CENTER HOLES IN OD CENTER
<b>49000 Series</b>											
49150	38.100 1.5000	31.750 1.2500	3.5 .14	.74 kg 1.64 lb	*49368-B	93.662 3.6875	25.400 1.0000	3.3 .13	.42 kg .92 lb	11.907 .4688	49368-B : FLANGE ON OD FRONTFACE, BEARING WIDTH IS T1 DIMENSION
49151	38.100 1.5000	31.750 1.2500	.8 .03	.75 kg 1.66 lb	49368	93.662 3.6875	25.400 1.0000	3.3 .13	.36 kg .79 lb	31.750 1.2500	
49162	41.275 1.6250	31.750 1.2500	3.5 .14	.69 kg 1.53 lb							
49175	44.450 1.7500	31.750 1.2500	3.5 .14	.64 kg 1.41 lb							
49176	44.450 1.7500	31.750 1.2500	.8 .03	.65 kg 1.43 lb							
<b>49500 Series</b>											
49576	44.450 1.7500	31.750 1.2500	.8 .03	.86 kg 1.90 lb	49520	101.600 4.0000	25.400 1.0000	3.3 .13	.38 kg .84 lb	31.750 1.2500	49520-B : FLANGE ON OD FRONTFACE, BEARING WIDTH IS T1 DIMENSION
49577	44.450 1.7500	31.750 1.2500	3.5 .14	.86 kg 1.89 lb	*49520-B	101.600 4.0000	25.400 1.0000	spcl. spcl.	.44 kg .98 lb	11.908 .4688	SPECIAL RADIUS ON BACKFACE OD
49580	47.625 1.8750	31.750 1.2500	3.5 .14	.80 kg 1.76 lb	*49520W	101.600 4.0000	25.400 1.0000	3.3 .13	.41 kg .90 lb	31.750 1.2500	49520W : KEYWAY BACKFACE
49581	47.625 1.8750	31.750 1.2500	6.4 .25	.78 kg 1.72 lb	49521	101.600 4.0000	28.575 1.1250	3.3 .13	.45 kg 1.00 lb	34.925 1.3750	
49585	50.800 2.0000	31.750 1.2500	3.5 .14	.74 kg 1.63 lb	49522	101.600 4.0000	25.400 1.0000	.8 .03	.39 kg .86 lb	31.750 1.2500	
<b>52000 Series</b>											
*52374DE	95.000 3.7402	158.750 6.2500	.8 .03	6.81 kg 15.02 lb	52618	157.162 6.1875	26.195 1.0313	3.3 .13	.69 kg 1.52 lb	73.022 2.8749	52374DE: EXTENDED SMALL RIB
*52392DE	100.000 3.9370	158.750 6.2500	.8 .03	5.87 kg 12.95 lb	52630X	160.000 6.2992	26.195 1.0313	3.0 .12	.83 kg 1.84 lb	73.022 2.8749	NA52375T: REVERSE TAPERED BORE
*52392DEE	100.000 3.9370	158.750 6.2500	.8 .03	5.90 kg 13.01 lb	52637	161.925 6.3750	26.195 1.0313	3.3 .13	.93 kg 2.05 lb	73.022 2.8749	NA52391T: TAPERED BORE
*52393DA	100.012 3.9375	133.350 5.2500	.8 .03	5.45 kg 12.01 lb	52638	161.925 6.3750	29.370 1.1563	3.3 .13	1.10 kg 2.42 lb	79.372 3.1249	52392DE: EXTENDED SMALL RIB
*52393DAA	100.012 3.9375	133.350 5.2500	.8 .03	5.45 kg 12.01 lb	52639	161.925 6.3750	39.688 1.5625	3.3 .13	1.32 kg 2.92 lb	82.547 3.2499	52392DEE: EXTENDED SMALL RIB
*52393DE	100.012 3.9375	158.750 6.2500	.8 .03	5.62 kg 12.39 lb							52393DA: ASYMMETRICAL BEARING HOLES IN OD LEFTFACE
*52393DEE	100.012 3.9375	158.750 6.2500	.8 .03	5.62 kg 12.39 lb							52393DAA: ASYMMETRICAL BEARING HOLES IN OD LEFTFACE

\*\*These Maximum Fillet Radii will be cleared by the Cone or Cup Radii.  
†Bore or O.D. shown are maximum dimensions. \*See Remarks Column.

52000 – 53000 SERIES

5

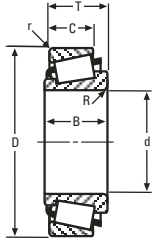

SINGLE ROW



SINGLE ROW WITH FLANGE

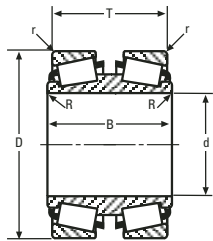

DOUBLE CONE

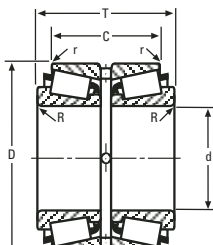

DOUBLE CUP

CONE				Weight	CUP			Weight	BEARING		Remarks
Number	BORE d	WIDTH B	Max Shaft Fillet Radii R <sup>**</sup>		Number	OUTSIDE DIA D	WIDTH C		Max Hs'ng Fillet Radii r <sup>**</sup>	WIDTH T	
<b>52000 Series (cont)</b>											
*52400DA	101.600 4.0000	133.350 5.2500	.8 .03	5.15 kg 11.37 lb							52393DE: EXTENDED SMALL RIB
*52400DE	101.600 4.0000	158.750 6.2500	.8 .03	5.32 kg 11.74 lb							52393DEE: EXTENDED SMALL RIB
*52400DEE	101.600 4.0000	158.750 6.2500	.8 .03	5.32 kg 11.74 lb							52394TD: TAPERED BORE
52375	95.250 3.7500	36.116 1.4219	3.5 .14	1.99 kg 4.38 lb	52618	157.162 6.1875	26.195 1.0313	3.3 .13	.69 kg 1.52 lb	36.512 1.4375	52400A: SPECIAL FRONTFACE RADIUS
52387	98.425 3.8750	36.116 1.4219	3.5 .14	1.85 kg 4.07 lb	*52618-B	157.162 6.1875	26.195 1.0313	3.3 .13	.77 kg 1.70 lb	16.667 .6562	52400DA: HOLES IN OD LEFTFACE
52387W	98.425 3.8750	36.116 1.4219	3.5 .14	1.84 kg 4.06 lb	*52625DA	158.750 6.2500	61.912 2.4375	.8 .03	1.96 kg 4.33 lb	82.547 3.2499	52400DE: EXTENDED SMALL RIB
52393	100.012 3.9375	36.116 1.4219	3.5 .14	1.78 kg 3.92 lb	52630X	160.000 6.2992	26.195 1.0313	3.0 .12	.83 kg 1.84 lb	36.512 1.4375	52400DEE: EXTENDED SMALL RIB
52394X	100.000 3.9370	36.116 1.4219	3.5 .14	1.78 kg 3.92 lb	*52630XB	160.000 6.2992	26.195 1.0313	3.3 .13	.94 kg 2.07 lb	16.667 .6562	52402: HOLES IN BACKFACE TO UNDERCUT
52400	101.600 4.0000	36.116 1.4219	3.5 .14	1.72 kg 3.80 lb	52637	161.925 6.3750	26.195 1.0313	3.3 .13	.93 kg 2.05 lb	36.512 1.4375	52618-B: FLANGE ON OD FRONTFACE, BEARING WIDTH IS T1 DIMENSION
*52400A	101.600 4.0000	36.116 1.4219	3.5 .14	1.72 kg 3.80 lb	*52637-B	161.925 6.3750	26.195 1.0313	3.3 .13	1.02 kg 2.25 lb	16.667 .6562	52625DA: HOLES IN OD CENTER
52401	101.600 4.0000	36.116 1.4219	8.0 .31	1.72 kg 3.80 lb	*52637D	161.925 6.3750	61.912 2.4375	.8 .03	2.35 kg 5.19 lb	82.547 3.2499	52630XB: FLANGE ON OD FRONTFACE, BEARING WIDTH IS T1 DIMENSION
*52402	101.600 4.0000	36.116 1.4219	3.5 .14	-	*52637DC	161.925 6.3750	61.912 2.4375	.8 .03	2.35 kg 5.19 lb	82.547 3.2499	52637-B: FLANGE ON OD FRONTFACE, BEARING WIDTH IS T1 DIMENSION
					52638	161.925 6.3750	29.370 1.1563	3.3 .13	1.10 kg 2.42 lb	39.687 1.5625	52637D: GROOVE IN OD CENTER HOLES IN OD CENTER
					52639	161.925 6.3750	39.688 1.5625	3.3 .13	1.32 kg 2.92 lb	41.275 1.6250	
					*52687DA	174.625 6.8750	61.912 2.4375	spcl. spcl.	3.68 kg 8.11 lb	82.547 3.2499	52637DC: HOLES IN OD CENTER 52687DA: HOLES IN OD CENTER SPECIAL RADIUS ON LEFTFACE OD SPECIAL RADIUS ON RIGHTFACE OD SPHERICAL OD
NA52375	95.250 3.7500	41.275 1.6250	3.5 .14	4.22 kg 9.30 lb	*52625DA	158.750 6.2500	61.912 2.4375	.8 .03	1.96 kg 4.33 lb	82.550 3.2500	
*NA52375T	97.394 3.8344	41.275 1.6250	3.5 .14	4.51 kg 9.94 lb	*52637D	161.925 6.3750	61.912 2.4375	.8 .03	2.35 kg 5.19 lb	82.550 3.2500	
*NA52391T	99.548 3.9192	41.275 1.6250	3.5 .14	4.30 kg 9.47 lb	*52637DC	161.925 6.3750	61.912 2.4375	.8 .03	2.35 kg 5.19 lb	82.550 3.2500	
					*52687DA	174.625 6.8750	61.912 2.4375	spcl. spcl.	3.68 kg 8.11 lb	82.550 3.2500	
52387D	98.425 3.8750	79.375 3.1250	.8 .03	4.68 kg 10.33 lb	52387D and grouped cones may be paired with all single cups corresponding to 52374DE and will require 7.145 mm (.2813 in) to be added to the T-width values.						
52388D	98.425 3.8750	79.375 3.1250	1.5 .06	4.69 kg 10.33 lb							
52400D	101.600 4.0000	79.375 3.1250	1.5 .06	4.38 kg 9.67 lb							
*52394TD	100.211 3.9453	95.250 3.7500	.8 .03	5.57 kg 12.29 lb	52394TD may be paired with all single cups corresponding to 52374DE and will require 23.020 mm (.9063 in) to be added to the T-width values.						
<b>LL52500 Series</b>											
LL52549	22.225 .8750	11.176 .4400	1.3 .05	.04 kg .10 lb	LL52510	42.070 1.6563	8.636 .3400	1.3 .05	.02 kg .05 lb	11.176 .4400	
<b>53000 Series</b>											
53150	38.100 1.5000	28.300 1.1142	1.5 .06	.68 kg 1.49 lb	53375	95.250 3.7500	20.638 .8125	.8 .03	.36 kg .80 lb	30.956 1.2188	53175T: TAPERED BORE
53162	41.275 1.6250	28.300 1.1142	1.5 .06	.63 kg 1.39 lb	*53376D	95.250 3.7500	44.450 1.7500	.8 .03	.73 kg 1.61 lb	65.088 2.5625	53376D: GROOVE IN OD CENTER HOLES IN OD CENTER
53162W	41.275 1.6250	28.300 1.1142	1.5 .06	.63 kg 1.38 lb	53377	95.250 3.7500	20.638 .8125	2.3 .09	.36 kg .79 lb	30.956 1.2188	53387-B: FLANGE ON OD FRONTFACE, BEARING WIDTH IS T1 DIMENSION

53000 SERIES CONTINUED ON NEXT PAGE

\*\*These Maximum Fillet Radii will be cleared by the Cone or Cup Radii.  
†Bore or O.D. shown are maximum dimensions. \*See Remarks Column.

5

CONE			Max Shaft Fillet Radii R''	Weight	CUP			Max Hs'ng Fillet Radii r''	Weight	BEARING	Remarks
Number	BORE d	WIDTH B			Number	OUTSIDE DIA D	WIDTH C			WIDTH T	
<b>53000 Series (cont)</b>											
*53175T	44.450 1.7500	28.300 1.1142	2.3 .09	.60 kg 1.32 lb	53387	98.425 3.8750	20.638 .8125	.8 .03	.44 kg .97 lb	30.956 1.2188	53390D : GROOVE IN OD CENTER HOLES IN OD CENTER
53176	44.450 1.7500	28.300 1.1142	1.3 .05	.59 kg 1.29 lb	*53387-B	98.425 3.8750	20.638 .8125	.8 .03	.49 kg 1.08 lb	16.670 .6563	
53177	44.450 1.7500	28.300 1.1142	3.5 .14	.58 kg 1.28 lb	53387X	98.425 3.8750	20.638 .8125	1.5 .06	.44 kg .97 lb	30.956 1.2188	
53178	44.450 1.7500	28.300 1.1142	2.0 .08	.58 kg 1.29 lb	*53390D	98.425 3.8750	44.450 1.7500	1.5 .06	.91 kg 2.02 lb	65.088 2.5625	
					53394	99.985 3.9364	20.638 .8125	2.3 .09	.47 kg 1.05 lb	30.956 1.2188	
					53398	101.600 4.0000	20.638 .8125	.8 .03	.52 kg 1.15 lb	30.956 1.2188	
NA53176	44.450 1.7500	32.545 1.2813	2.3 .09	1.22 kg 2.68 lb	*53376D	95.250 3.7500	44.450 1.7500	.8 .03	.73 kg 1.61 lb	65.090 2.5626	
					*53390D	98.425 3.8750	44.450 1.7500	1.5 .06	.91 kg 2.02 lb	65.090 2.5626	
<b>M53600 Series</b>											
M53648	22.225 .8750	18.258 .7188	1.3 .05	- -	*M53611	57.150 2.2500	16.670 .6563	1.5 .06	.11 kg .23 lb	19.050 .7500	
<b>55000 Series</b>											
55175	44.450 1.7500	26.909 1.0594	3.5 .14	.87 kg 1.92 lb	*55433DC	109.982 4.3300	42.865 1.6876	.5 .02	1.05 kg 2.31 lb	63.500 2.5000	NA55200-SW: FRONTFACE CHAMFER SLOTS IN FRONTFACE
					55176	44.450 1.7500	26.909 1.0594	.8 .03	.87 kg 1.93 lb	*55433D	
55187	47.625 1.8750	26.909 1.0594	3.5 .14	.82 kg 1.81 lb	55434	109.985 4.3301	19.726 .7766	3.0 .12	.44 kg .97 lb	29.251 1.1516	55433DC : HOLES IN OD CENTER
55195	49.987 1.9680	26.909 1.0594	3.0 .12	.78 kg 1.73 lb	55437	111.125 4.3750	20.638 .8125	3.3 .13	.50 kg 1.10 lb	30.163 1.1875	55444D : GROOVE IN OD CENTER HOLES IN OD CENTER
55197	49.974 1.9675	26.909 1.0594	2.0 .08	.79 kg 1.74 lb	*55444D	112.712 4.4375	46.038 1.8125	1.5 .06	1.20 kg 2.64 lb	65.087 2.5625	55452D : GROOVE IN OD CENTER HOLES IN OD CENTER
55206	52.388 2.0625	26.909 1.0594	3.5 .14	.74 kg 1.63 lb	*55444D	112.712 4.4375	46.038 1.8125	1.5 .06	1.20 kg 2.64 lb	65.085 2.5624	55452D : GROOVE IN OD CENTER HOLES IN OD CENTER
NA55200	50.800 2.0000	32.542 1.2812	2.3 .09	-	*55433DC	109.982 4.3300	42.865 1.6876	.5 .02	1.05 kg 2.31 lb	65.085 2.5624	55433D : GROOVE IN OD CENTER HOLES IN OD CENTER
55194X	49.987 1.9680	28.486 1.1215	4.3 .17	.82 kg 1.81 lb	*55444D	112.712 4.4375	46.038 1.8125	1.5 .06	1.20 kg 2.64 lb	65.085 2.5624	55452D : GROOVE IN OD CENTER HOLES IN OD CENTER
55194X may be paired with all single cups corresponding to 55175 and will require 1.588 mm (.0625 in) to be added to the T-width values. 55194X may be paired with all double cups corresponding to 55175 and will require 3.175 mm (.1250 in) to be added to the T-width values.											
<b>55000C Series</b>											
55175C	44.450 1.7500	26.909 1.0594	3.5 .14	.96 kg 2.11 lb	*55433D	109.982 4.3300	42.865 1.6876	.5 .02	1.07 kg 2.36 lb	63.500 2.5000	55433D : GROOVE IN OD CENTER HOLES IN OD CENTER
55187C	47.625 1.8750	26.909 1.0594	3.5 .14	.91 kg 2.00 lb	*55437-B	111.125 4.3750	20.638 .8125	3.3 .13	.53 kg 1.16 lb	15.083 .5938	55452D : GROOVE IN OD CENTER HOLES IN OD CENTER
55206C	52.388 2.0625	26.909 1.0594	3.5 .14	.83 kg 1.83 lb	55443	112.712 4.4375	20.638 .8125	3.3 .13	.54 kg 1.20 lb	30.163 1.1875	55452D : GROOVE IN OD CENTER HOLES IN OD CENTER

\*\*These Maximum Fillet Radii will be cleared by the Cone or Cup Radii.  
†Bore or O.D. shown are maximum dimensions. \*See Remarks Column.

56000 – 64000 SERIES

5

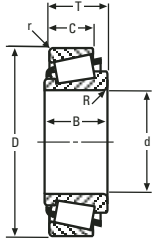

SINGLE ROW

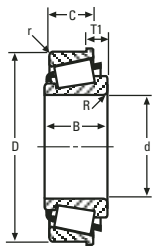

SINGLE ROW WITH FLANGE

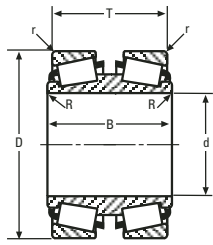

DOUBLE CONE

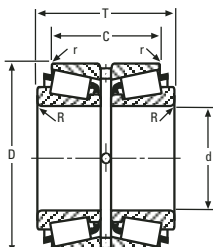

DOUBLE CUP

CONE			Max Shaft Fillet Radii R <sup>**</sup>	Weight	CUP			Max H's'ng Fillet Radii r <sup>**</sup>	Weight	BEARING WIDTH T	Remarks
Number	BORE d	WIDTH B			Number	OUTSIDE DIA D	WIDTH C				
<b>56000 Series</b>											
*NA56393-SW	99.974 3.9360	44.450 1.7500	3.5 .14	5.11 kg 11.27 lb	*56649D 164.976 6.4951	63.500 2.5000	.8 .03	2.14 kg 4.72 lb	88.900 3.5000	NA56393-SW: EXTENDED LARGE RIB FRONTFACE CHAMFER SLOTS IN FRONTFACE	
*NA56425-SW	107.950 4.2500	44.450 1.7500	3.5 .14	4.20 kg 9.26 lb	*56650CD 165.100 6.5000	63.500 2.5000	.8 .03	2.15 kg 4.75 lb	88.900 3.5000	NA56425-SW: EXTENDED LARGE RIB FRONTFACE CHAMFER SLOTS IN FRONTFACE	
					*56650D 165.100 6.5000	63.500 2.5000	.8 .03	2.15 kg 4.75 lb	88.900 3.5000	56649D: GROOVE IN OD CENTER HOLES IN OD CENTER	
					*56650DC 165.100 6.5000	63.500 2.5000	.8 .03	2.15 kg 4.75 lb	88.900 3.5000	56650-B: FLANGE ON OD FRONTFACE, BEARING WIDTH IS T1 DIMENSION	
					*K105665 256.659 10.1047	101.600 4.0000	spcl. spcl.	26.41 kg 58.23 lb	88.900 3.5000	56650DC: GROOVE IN OD CENTER HOLES IN OD CENTER	
					*K105666 256.659 10.1047	101.600 4.0000	spcl. spcl.	26.41 kg 58.23 lb	88.900 3.5000	56649D: GROOVE IN OD CENTER HOLES IN OD CENTER	
56418	106.362 4.1875	36.512 1.4375	3.5 .14	1.86 kg 4.09 lb	*56649D 164.976 6.4951	63.500 2.5000	.8 .03	2.14 kg 4.72 lb	82.550 3.2500	56650D: GROOVE IN OD CENTER HOLES IN OD CENTER	
56425	107.950 4.2500	36.512 1.4375	3.5 .14	1.78 kg 3.92 lb	56650 165.100 6.5000	26.988 1.0625	3.3 .13	.84 kg 1.86 lb	36.512 1.4375	K105665: FLANGE ON OD LEFTFACE HOLES IN LEFTFACE SPECIAL RADIUS ON LEFTFACE OD SPECIAL RADIUS ON RIGHTFACE OD TAPERED OD	
56425W	107.950 4.2500	36.512 1.4375	3.5 .14	1.86 kg 4.11 lb	*56650-B 165.100 6.5000	26.988 1.0625	3.3 .13	.97 kg 2.13 lb	15.875 .6250		
56426	107.950 4.2500	36.512 1.4375	8.0 .31	1.71 kg 3.77 lb	*56650CD 165.100 6.5000	63.500 2.5000	.8 .03	2.15 kg 4.75 lb	82.550 3.2500		
					*56650D 165.100 6.5000	63.500 2.5000	.8 .03	2.15 kg 4.75 lb	82.550 3.2500		
					*56650DC 165.100 6.5000	63.500 2.5000	.8 .03	2.15 kg 4.75 lb	82.550 3.2500		
					56662 168.275 6.6250	26.988 1.0625	3.3 .13	1.02 kg 2.24 lb	36.512 1.4375	K105666: FLANGE ON OD LEFTFACE SPECIAL RADIUS ON LEFTFACE OD SPECIAL RADIUS ON RIGHTFACE OD TAPERED OD	
NA56424A	107.942 4.2497	41.275 1.6250	3.5 .14	3.73 kg 8.21 lb	NA56424A may be paired with all double cups corresponding to NA56393-SW and will require -.6350 mm (-.2500 in) to be added to the T-width values.						
<b>59000 Series</b>											
59162	41.275 1.6250	36.512 1.4375	1.5 .06	1.14 kg 2.52 lb	*59412-B 104.775 4.1250	28.575 1.1250	3.3 .13	.50 kg 1.11 lb	11.907 .4688	59201T: TAPERED BORE	
59175	44.450 1.7500	36.512 1.4375	3.5 .14	1.08 kg 2.37 lb	59412 104.775 4.1250	28.575 1.1250	3.3 .13	.47 kg 1.03 lb	36.512 1.4375	59412-B: FLANGE ON OD FRONTFACE, BEARING WIDTH IS T1 DIMENSION	
59176	44.450 1.7500	36.512 1.4375	.8 .03	1.08 kg 2.39 lb	59413 104.775 4.1250	28.575 1.1250	.8 .03	.48 kg 1.05 lb	36.512 1.4375	59414-B: CHAMFER ON FRONTFACE OD FLANGE ON OD FRONTFACE, BEARING WIDTH IS T1 DIMENSION	
59187	47.625 1.8750	36.512 1.4375	3.5 .14	1.01 kg 2.23 lb	*59414-B 104.775 4.1250	28.575 1.1250	3.3 .13	.53 kg 1.17 lb	11.907 .4688	59429-B: FLANGE ON OD FRONTFACE, BEARING WIDTH IS T1 DIMENSION	
59188	47.625 1.8750	36.512 1.4375	1.5 .06	1.02 kg 2.24 lb	59425 107.950 4.2500	28.575 1.1250	3.3 .13	.58 kg 1.29 lb	36.512 1.4375		
59200	50.800 2.0000	36.512 1.4375	3.5 .14	.94 kg 2.07 lb	*59429-B 108.966 4.2900	26.988 1.0625	3.3 .13	.64 kg 1.42 lb	14.287 .5625		
59201	50.800 2.0000	36.512 1.4375	.8 .03	.95 kg 2.09 lb	*59429RB 108.966 4.2900	26.988 1.0625	3.3 .13	.59 kg 1.30 lb	34.925 1.3750	59429RB: GROOVE IN OD FRONTFACE	
*59201T	50.800 2.0000	36.512 1.4375	3.5 .14	1.01 kg 2.23 lb	59429 108.966 4.2900	26.988 1.0625	3.3 .13	.58 kg 1.27 lb	34.925 1.3750		
<b>64000 Series</b>											
64373	94.983 3.7395	41.275 1.6250	1.5 .06	3.37 kg 7.44 lb	64700 177.800 7.0000	30.162 1.1875	3.3 .13	1.09 kg 2.41 lb	41.275 1.6250	64418DE: EXTENDED SMALL RIB	
64432	109.974 4.3297	41.275 1.6250	3.5 .14	2.61 kg 5.75 lb	*64700-B 177.800 7.0000	30.162 1.1875	3.3 .13	1.30 kg 2.88 lb	18.258 .7188	NA64432-SW: EXTENDED LARGE RIB FRONTFACE CHAMFER SLOTS IN FRONTFACE	
64433	109.992 4.3304	41.275 1.6250	3.5 .14	2.61 kg 5.75 lb	*64700D 177.800 7.0000	69.850 2.7500	.8 .03	2.93 kg 6.46 lb	92.074 3.6250	64434DE: EXTENDED SMALL RIB	
64437	111.125 4.3750	41.275 1.6250	3.5 .14	2.54 kg 5.61 lb	*64700DC 177.800 7.0000	69.850 2.7500	.8 .03	2.94 kg 6.48 lb	92.074 3.6250	64434DEE: EXTENDED SMALL RIB	
64450	114.300 4.5000	41.275 1.6250	3.5 .14	2.36 kg 5.21 lb	*64700V 177.800 7.0000	30.162 1.1875	3.3 .13	1.09 kg 2.41 lb	41.275 1.6250	64443DA: ASYMMETRICAL BEARING EXTENDED SMALL RIB HOLES IN OD LEFTFACE	
*64450V	114.300 4.5000	41.275 1.6250	3.5 .14	2.24 kg 4.95 lb	64701X 178.000 7.0079	30.162 1.1875	3.0 .12	1.11 kg 2.45 lb	41.275 1.6250		

64000 SERIES CONTINUED ON NEXT PAGE

\*\*These Maximum Fillet Radii will be cleared by the Cone or Cup Radii.  
†Bore or O.D. shown are maximum dimensions. \*See Remarks Column.

5

CONE			Max Shaft Fillet Radii R''	Weight	CUP			Max Hs'ng Fillet Radii r''	Weight	BEARING	Remarks
Number	BORE d	WIDTH B			Number	OUTSIDE DIA D	WIDTH C			WIDTH T	
<b>64000 Series (cont)</b>											
64450W	114.300 4.5000	41.275 1.6250	3.5 .14	2.25 kg 4.95 lb	64708	179.974 7.0856	30.162 1.1875	3.3 .13	1.24 kg 2.73 lb	41.275 1.6250	64443DE: EXTENDED SMALL RIB
64452	114.976 4.5266	41.275 1.6250	3.5 .14	2.32 kg 5.12 lb	*64708D	179.974 7.0856	69.850 2.7500	.8 .03	3.27 kg 7.20 lb	92.074 3.6250	64443DEE: EXTENDED SMALL RIB
64452A	114.976 4.5266	41.275 1.6250	9.0 .35	2.22 kg 4.90 lb	64713	180.975 7.1250	30.162 1.1875	3.3 .13	1.30 kg 2.88 lb	41.275 1.6250	64450DE: EXTENDED SMALL RIB 64450DEE: EXTENDED SMALL RIB
*64418DE	105.000 4.1339	171.450 6.7500	.8 .03	9.61 kg 21.18 lb	64700	177.800 7.0000	30.162 1.1875	3.3 .13	1.09 kg 2.41 lb	82.550 3.2500	64450V: MADE FROM VACUUM MELT STEEL
*64434DE	110.000 4.3307	171.450 6.7500	.8 .03	8.49 kg 18.72 lb	*64700V	177.800 7.0000	30.162 1.1875	3.3 .13	1.09 kg 2.41 lb	82.550 3.2500	64453DE: EXTENDED SMALL RIB
*64434DEE	110.000 4.3307	171.450 6.7500	.8 .03	8.49 kg 18.72 lb	64701X	178.000 7.0079	30.162 1.1875	3.0 .12	1.11 kg 2.45 lb	82.550 3.2500	64453DEE: EXTENDED SMALL RIB
*64434DA	112.712 4.4375	142.875 5.6250	.8 .03	7.27 kg 16.03 lb	64708	179.974 7.0856	30.162 1.1875	3.3 .13	1.24 kg 2.73 lb	82.550 3.2500	64700-B : FLANGE ON OD FRONTFACE, BEARING WIDTH IS T1 DIMENSION
*64443DE	112.712 4.4375	171.450 6.7500	.8 .03	8.06 kg 17.78 lb	64713	180.975 7.1250	30.162 1.1875	3.3 .13	1.30 kg 2.88 lb	82.550 3.2500	64700D : GROOVE IN OD CENTER HOLES IN OD CENTER
*64443DEE	112.712 4.4375	171.450 6.7500	.8 .03	8.06 kg 17.78 lb							64700DC : HOLES IN OD CENTER
*64450DE	114.300 4.5000	171.450 6.7500	.8 .03	7.70 kg 16.97 lb							64700V : MADE FROM VACUUM MELT STEEL
*64450DEE	114.300 4.5000	171.450 6.7500	.8 .03	7.70 kg 16.97 lb							64708D : GROOVE IN OD CENTER HOLES IN OD CENTER
*64453DE	115.000 4.5276	171.450 6.7500	.8 .03	7.32 kg 16.13 lb							
*64453DEE	115.000 4.5276	171.450 6.7500	.8 .03	7.32 kg 16.13 lb							
*NA64432-SW	109.974 4.3297	50.800 2.0000	3.5 .14	5.96 kg 13.14 lb	*64700D	177.800 7.0000	69.850 2.7500	.8 .03	2.93 kg 6.46 lb	101.600 4.0000	
					*64700DC	177.800 7.0000	69.850 2.7500	.8 .03	2.94 kg 6.48 lb	101.600 4.0000	
					*64708D	179.974 7.0856	69.850 2.7500	.8 .03	3.27 kg 7.20 lb	101.600 4.0000	
64452X	115.000 4.5276	40.000 1.5748	3.5 .14	2.25 kg 4.97 lb	64452X may be paired with all single cups corresponding to 64373 and will require -1.275 mm (-.0502 in) to be added to the T-width values. 64452X may be paired with all double cups corresponding to 64373 and will require -2.550 mm (-.1004 in) to be added to the T-width values.						
<b>65000 Series</b>											
65200	50.800 2.0000	44.450 1.7500	3.5 .14	1.86 kg 4.10 lb	*65500-B	127.000 5.0000	34.925 1.3750	3.3 .13	1.13 kg 2.49 lb	16.670 .6563	65500-B : FLANGE ON OD FRONTFACE, BEARING WIDTH IS T1 DIMENSION
65201	50.800 2.0000	46.038 1.8125	.8 .03	1.89 kg 4.16 lb	65500	127.000 5.0000	34.925 1.3750	3.3 .13	1.02 kg 2.25 lb	44.450 1.7500	65550-B : FLANGE ON OD FRONTFACE, BEARING WIDTH IS T1 DIMENSION
65212	53.975 2.1250	44.450 1.7500	3.5 .14	1.77 kg 3.90 lb	65501	127.000 5.0000	34.925 1.3750	1.3 .05	1.03 kg 2.28 lb	44.450 1.7500	
65225	57.150 2.2500	44.450 1.7500	3.5 .14	1.67 kg 3.68 lb	65537	136.525 5.3750	36.512 1.4375	3.0 .12	1.65 kg 3.64 lb	46.037 1.8125	
65231	58.738 2.3125	44.450 1.7500	3.5 .14	1.62 kg 3.57 lb	*65550-B	139.700 5.5000	34.925 1.3750	3.3 .13	1.93 kg 4.26 lb	17.462 .6875	
65235	59.880 2.3575	44.450 1.7500	3.5 .14	1.58 kg 3.49 lb							
65237	60.325 2.3750	44.450 1.7500	3.5 .14	1.57 kg 3.46 lb							
65237A	60.325 2.3750	44.450 1.7500	1.5 .06	1.58 kg 3.47 lb							
<b>65300 Series</b>											
65383	42.862 1.6875	44.450 1.7500	2.0 .08	1.49 kg 3.28 lb	*65320-B	114.300 4.5000	34.925 1.3750	3.3 .13	.98 kg 2.17 lb	16.670 .6563	65320-B : FLANGE ON OD FRONTFACE, BEARING WIDTH IS T1 DIMENSION
65384	44.450 1.7500	44.450 1.7500	2.0 .08	1.45 kg 3.19 lb	65320	114.300 4.5000	34.925 1.3750	3.3 .13	.87 kg 1.91 lb	44.450 1.7500	
65385	44.450 1.7500	44.450 1.7500	3.5 .14	1.44 kg 3.18 lb	65321	114.300 4.5000	34.925 1.3750	.8 .03	.88 kg 1.94 lb	44.450 1.7500	
65390	49.212 1.9375	44.450 1.7500	3.5 .14	1.32 kg 2.91 lb							

\*\*These Maximum Fillet Radii will be cleared by the Cone or Cup Radii.  
†Bore or O.D. shown are maximum dimensions. \*See Remarks Column.

65300 – LM67000 SERIES

5

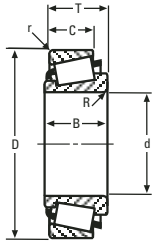

SINGLE ROW



SINGLE ROW WITH FLANGE

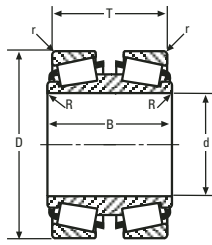

DOUBLE CONE

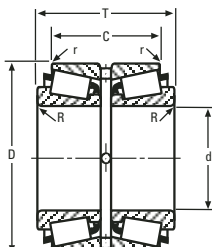

DOUBLE CUP

CONE			Max Shaft Fillet Radii R <sup>**</sup>	Weight	CUP			Max Hs'ng Fillet Radii r <sup>**</sup>	Weight	BEARING	Remarks
Number	BORE d	WIDTH B			Number	OUTSIDE DIA D	WIDTH C			WIDTH T	
<b>65300 Series (cont)</b>											
65395	50.800 2.0000	44.450 1.7500	3.5 .14	1.28 kg 2.82 lb							
<b>66000 Series</b>											
66187	47.625 1.8750	31.750 1.2500	3.5 .14	1.16 kg 2.57 lb	66461	117.475 4.6250	23.812 .9375	.8 .03	.55 kg 1.22 lb	33.338 1.3125	66462-B : FLANGE ON OD FRONTFACE, BEARING WIDTH IS T1 DIMENSION
66200	50.800 2.0000	31.750 1.2500	3.5 .14	1.10 kg 2.43 lb	66462	117.475 4.6250	23.812 .9375	3.3 .13	.54 kg 1.19 lb	33.338 1.3125	66462D : GROOVE IN OD CENTER HOLES IN OD CENTER
66212	53.975 2.1250	31.750 1.2500	3.5 .14	1.04 kg 2.29 lb	*66462-B	117.475 4.6250	23.812 .9375	3.3 .13	.59 kg 1.31 lb	15.875 .6250	
66225	57.150 2.2500	31.750 1.2500	3.5 .14	.97 kg 2.13 lb	*66462D	117.475 4.6250	53.975 2.1250	.8 .03	1.37 kg 3.01 lb	73.025 2.8750	
NA66212	53.975 2.1250	36.512 1.4375	3.5 .14	2.19 kg 4.84 lb	*66462D	117.475 4.6250	53.975 2.1250	.8 .03	1.37 kg 3.01 lb	73.025 2.8750	
<b>66500 Series</b>											
66583	55.753 2.1950	31.750 1.2500	1.5 .06	1.21 kg 2.66 lb	66520	122.238 4.8125	23.812 .9375	3.3 .13	.54 kg 1.20 lb	33.338 1.3125	66521DB : ASYMMETRICAL BEARING FLANGE ON OD LEFTFACE GROOVE IN OD LEFTFACE HOLES IN OD CENTER SPECIAL RADIUS ON LEFTFACE OD SPECIAL RADIUS ON RIGHTFACE OD
66584	53.975 2.1250	31.750 1.2500	3.5 .14	1.24 kg 2.73 lb	*66521DB	127.025 5.0010	52.324 2.0600	4.5 .18	2.03 kg 4.48 lb	71.374 2.8100	
66585	60.000 2.3622	31.750 1.2500	3.5 .14	1.10 kg 2.43 lb	*66522D	129.982 5.1174	47.625 1.8750	.8 .03	1.70 kg 3.74 lb	69.850 2.7500	66522D : GROOVE IN OD CENTER HOLES IN OD CENTER
66586	59.977 2.3613	31.750 1.2500	1.5 .06	1.11 kg 2.45 lb							
66587	57.150 2.2500	31.750 1.2500	3.5 .14	1.17 kg 2.58 lb							
66588	60.000 2.3622	31.750 1.2500	.8 .03	1.11 kg 2.45 lb							
66589	59.972 2.3611	31.750 1.2500	.8 .03	1.11 kg 2.45 lb							
<b>67000 Series</b>											
67425	107.950 4.2500	30.162 1.1875	3.5 .14	1.63 kg 3.60 lb	67675	171.450 6.7500	25.268 .9948	3.3 .13	.88 kg 1.93 lb	34.000 1.3386	
67425W	107.950 4.2500	30.162 1.1875	3.5 .14	1.72 kg 3.79 lb							
67434	110.332 4.3438	30.162 1.1875	3.5 .14	1.54 kg 3.39 lb							
67437	111.125 4.3750	30.162 1.1875	3.5 .14	1.50 kg 3.32 lb							
<b>LM67000 Series</b>											
*LM67041DA	25.400 1.0000	69.088 2.7200	.8 .03	.63 kg 1.38 lb	LM67010	59.131 2.3280	11.811 .4650	1.3 .05	.06 kg .14 lb	32.537 1.2810	LM67041DA: ASYMMETRICAL BEARING HOLES IN OD LEFTFACE
					LM67010-Z	59.131 2.3280	11.811 .4650	1.3 .05	.06 kg .14 lb	32.537 1.2810	LM67043: SPECIAL BACKFACE RADIUS
					LM67014	61.986 2.4404	11.811 .4650	1.3 .05	.09 kg .19 lb	32.537 1.2810	LM67045: EXTENDED SMALL RIB
					*LM67014X	61.986 2.4404	11.811 .4650	1.3 .05	.09 kg .19 lb	32.537 1.2810	LM67048: SPECIAL BACKFACE RADIUS
					LM67019	67.277 2.6487	16.256 .6400	1.3 .05	.20 kg .44 lb	41.427 1.6310	LM67048F: SPECIAL BACKFACE RADIUS
					†JLM67020P	58.514 2.3037	11.562 .4552	1.3 .05	.06 kg .12 lb	32.639 1.2850	LM67010-B : FLANGE ON OD FRONTFACE, BEARING WIDTH IS T1 DIMENSION
†JLM67042	27.000 1.0630	16.764 .6600	.5 .02	.15 kg .34 lb	LM67010	59.131 2.3280	11.811 .4650	1.3 .05	.06 kg .14 lb	15.875 .6250	LM67010-BA : CHAMFER ON FRONTFACE OD FLANGE ON OD FRONTFACE, BEARING WIDTH IS T1 DIMENSION
*LM67043	28.575 1.1250	16.764 .6600	spcl. spcl.	.14 kg .31 lb	*LM67010-B	59.131 2.3280	11.811 .4650	1.3 .05	.06 kg .14 lb	6.833 .2690	LM67010-BCE : FLANGE ON OD FRONTFACE, BEARING WIDTH IS T1 DIMENSION GROOVE IN OD BACKFACE
*LM67045	31.750 1.2500	18.500 .7283	2.0 .08	.13 kg .28 lb	*LM67010-BA	58.877 2.3180	11.811 .4650	1.3 .05	.07 kg .15 lb	6.833 .2690	LM67014X : GROOVE IN OD CENTER
LM67047	31.750 1.2500	16.764 .6600	2.3 .09	.12 kg .27 lb	*LM67010-BCE	59.131 2.3280	16.891 .6650	- -	.13 kg .29 lb	6.375 .2510	
*LM67048	31.750 1.2500	16.764 .6600	spcl. spcl.	.12 kg .25 lb	LM67010-Z	59.131 2.3280	11.811 .4650	1.3 .05	.06 kg .14 lb	15.875 .6250	

LM67000 SERIES CONTINUED ON NEXT PAGE

\*\*These Maximum Fillet Radii will be cleared by the Cone or Cup Radii.  
†Bore or O.D. shown are maximum dimensions. \*See Remarks Column.

LM67000 – 67300 SERIES

5

CONE			Max Shaft Fillet Radii R''	Weight	CUP			Max Hs'ng Fillet Radii r''	Weight	BEAR-ING	Remarks
Number	BORE d	WIDTH B			Number	OUTSIDE DIA D	WIDTH C			WIDTH T	
LM67000 Series (cont)											
*LM67048F	31.750 1.2500	16.764 .6600	spcl. spcl.	- -	LM67014	61.986 2.4404	11.811 .4650	1.3 .05	.09 kg .19 lb	15.875 .6250	
LM67049A	31.750 1.2500	16.764 .6600	.8 .03	.12 kg .28 lb	*LM67014X	61.986 2.4404	11.811 .4650	1.3 .05	.09 kg .19 lb	15.875 .6250	
					LM67019	67.277 2.6487	16.256 .6400	1.3 .05	.20 kg .44 lb	20.320 .8000	
					†JLM67020P	58.514 2.3037	11.562 .4552	1.3 .05	.06 kg .12 lb	15.890 .6256	
†JLM67041P	25.415 1.0005	16.231 .6390	.8 .03	.16 kg .35 lb	JLM67041P may be paired with all single cups corresponding to JLM67042 and will require -.533 mm (-.0210 in) to be added to the T-width values.						
67300 Series											
67384	120.650 4.7500	46.038 1.8125	8.0 .31	4.03 kg 8.88 lb	67320	203.200 8.0000	38.100 1.5000	3.3 .13	2.04 kg 4.49 lb	46.038 1.8125	NA67385T: REVERSE TAPERED BORE
67388	127.000 5.0000	46.038 1.8125	3.5 .14	3.65 kg 8.05 lb	*67320-B	203.200 8.0000	38.100 1.5000	3.3 .13	2.29 kg 5.05 lb	15.083 .5938	NA67389T: TAPERED BORE
67388W	127.000 5.0000	46.038 1.8125	3.5 .14	3.71 kg 8.17 lb	67322	196.850 7.7500	38.100 1.5000	3.3 .13	1.44 kg 3.18 lb	46.038 1.8125	67390TD: ASYMMETRICAL BEARING TAPERED BORE
67389	130.175 5.1250	46.038 1.8125	3.5 .14	3.42 kg 7.54 lb	*67322-B	196.850 7.7500	38.100 1.5000	3.3 .13	1.70 kg 3.74 lb	15.083 .5938	67391D: ASYMMETRICAL BEARING SHOULDER ON OD RIGHTFACE
67390	133.350 5.2500	46.038 1.8125	3.5 .14	3.18 kg 7.02 lb	*67322D	196.850 7.7500	85.725 3.3750	.8 .03	3.27 kg 7.21 lb	101.600 4.0000	67391DW: ASYMMETRICAL BEARING SHOULDER ON OD RIGHTFACE SLOTS IN LEFTFACE
67390W	133.350 5.2500	46.038 1.8125	3.5 .14	3.24 kg 7.14 lb	*67322DC	196.850 7.7500	85.725 3.3750	.8 .03	3.27 kg 7.21 lb	101.600 4.0000	67392TD: TAPERED BORE
67391	133.350 5.2500	46.038 1.8125	8.0 .31	3.17 kg 6.99 lb	*67323D	196.850 7.7500	92.075 3.6250	.8 .03	3.84 kg 8.47 lb	107.950 4.2500	67320-B : FLANGE ON OD FRONTFACE, BEARING WIDTH IS T1 DIMENSION
					67324	203.200 8.0000	46.038 1.8125	3.3 .13	2.28 kg 5.02 lb	46.037 1.8125	67322-B : FLANGE ON OD FRONTFACE, BEARING WIDTH IS T1 DIMENSION
					*67324DA	198.438 7.8125	85.725 3.3750	.8 .03	4.00 kg 8.83 lb	101.600 4.0000	67322D : GROOVE IN OD CENTER HOLES IN OD CENTER
					*67325D	200.025 7.8750	85.725 3.3750	.8 .03	4.34 kg 9.57 lb	101.600 4.0000	67322DC : HOLES IN OD CENTER
					*67326D	199.949 7.8720	85.725 3.3750	.8 .03	3.88 kg 8.55 lb	101.600 4.0000	67323D : GROOVE IN OD CENTER HOLES IN OD CENTER
					*67329DA	222.250 8.7500	85.725 3.3750	spcl. spcl.	8.45 kg 18.63 lb	101.600 4.0000	67326D : GROOVE IN OD CENTER HOLES IN OD CENTER
*NA67385T	126.962 4.9985	50.800 2.0000	3.5 .14	8.15 kg 17.98 lb	*67322D	196.850 7.7500	85.725 3.3750	.8 .03	3.27 kg 7.21 lb	101.600 4.0000	67329DA : HOLES IN OD CENTER SPECIAL RADIUS ON LEFTFACE OD
*NA67389T	131.200 5.1654	50.800 2.0000	3.5 .14	7.45 kg 16.44 lb	*67322DC	196.850 7.7500	85.725 3.3750	.8 .03	3.27 kg 7.21 lb	101.600 4.0000	67329DA : HOLES IN OD CENTER SPECIAL RADIUS ON RIGHTFACE OD
					*67323D	196.850 7.7500	92.075 3.6250	.8 .03	3.84 kg 8.47 lb	101.600 4.0000	67392TD: TAPERED BORE
					*67324DA	198.438 7.8125	85.725 3.3750	.8 .03	4.00 kg 8.83 lb	101.600 4.0000	67392TD: TAPERED BORE
					*67325D	200.025 7.8750	85.725 3.3750	.8 .03	4.34 kg 9.57 lb	101.600 4.0000	67392TD: TAPERED BORE
					*67326D	199.949 7.8720	85.725 3.3750	.8 .03	3.88 kg 8.55 lb	101.600 4.0000	67392TD: TAPERED BORE
					*67329DA	222.250 8.7500	85.725 3.3750	spcl. spcl.	8.45 kg 18.63 lb	101.600 4.0000	67392TD: TAPERED BORE
67388D	127.000 5.0000	92.075 3.6250	1.5 .06	9.05 kg 19.95 lb	67320	203.200 8.0000	38.100 1.5000	3.3 .13	2.04 kg 4.49 lb	92.075 3.6250	67392TD: TAPERED BORE
67390D	133.350 5.2500	92.075 3.6250	1.5 .06	8.11 kg 17.88 lb	67322	196.850 7.7500	38.100 1.5000	3.3 .13	1.44 kg 3.18 lb	92.075 3.6250	67392TD: TAPERED BORE
*67390TD	133.350 5.2500	92.075 3.6250	1.5 .06	8.17 kg 18.01 lb	67324	203.200 8.0000	46.038 1.8125	3.3 .13	2.28 kg 5.02 lb	92.075 3.6250	67392TD: TAPERED BORE
*67391D	130.175 5.1250	95.250 3.7500	1.5 .06	8.62 kg 19.00 lb							67392TD: TAPERED BORE
*67391DW	130.175 5.1250	95.250 3.7500	1.5 .06	8.37 kg 18.46 lb							67392TD: TAPERED BORE
*67392TD	133.350 5.2500	120.650 4.7500	1.5 .06	10.62 kg 23.42 lb	67392TD may be paired with all single cups corresponding to 67388D and will require 28.575 mm (1.1250 in) to be added to the T-width values.						

\*\*These Maximum Fillet Radii will be cleared by the Cone or Cup Radii.  
†Bore or O.D. shown are maximum dimensions. \*See Remarks Column.

67700 – 67800 SERIES

5

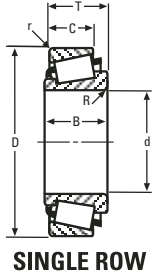

SINGLE ROW

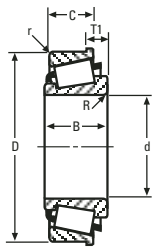

SINGLE ROW WITH FLANGE

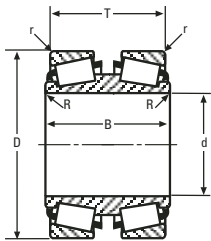

DOUBLE CONE

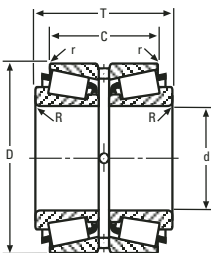

DOUBLE CUP

CONE			Max Shaft Fillet Radii R <sup>**</sup>	Weight	CUP			Max H's'ng Fillet Radii r <sup>**</sup>	Weight	BEARING WIDTH T	Remarks
Number	BORE d	WIDTH B			Number	OUTSIDE DIA D	WIDTH C				
<b>67700 Series</b>											
67780	165.100 6.5000	47.625 1.8750	3.5 .14	5.62 kg 12.39 lb	67720	247.650 9.7500	38.100 1.5000	3.3 .13	2.29 kg 5.05 lb	47.625 1.8750	67780V: MADE FROM VACUUM MELT STEEL
*67780V	165.100 6.5000	47.625 1.8750	3.5 .14	5.62 kg 12.39 lb	*67720-B	247.650 9.7500	38.100 1.5000	3.3 .13	2.82 kg 6.22 lb	16.670 .6563	67782DW: ASYMMETRICAL BEARING KEYWAY IN ID SHOULDER ON OD RIGHTFACE
67782	168.275 6.6250	47.625 1.8750	3.5 .14	5.31 kg 11.71 lb	*67720CD	247.650 9.7500	84.138 3.3125	.8 .03	5.41 kg 11.94 lb	103.187 4.0625	67787V: MADE FROM VACUUM MELT STEEL
67782W	168.275 6.6250	47.625 1.8750	3.5 .14	5.43 kg 11.97 lb	*67720DW	247.650 9.7500	93.662 3.6875	.8 .03	5.37 kg 11.85 lb	103.187 4.0625	NA67787W: KEYWAY IN ID
67786	174.625 6.8750	47.625 1.8750	8.0 .31	4.56 kg 10.06 lb	*67720V	247.650 9.7500	38.100 1.5000	3.3 .13	2.29 kg 5.05 lb	47.625 1.8750	67790TD: TAPERED BORE
67787	174.625 6.8750	47.625 1.8750	3.5 .14	4.67 kg 10.31 lb	*67721D	247.650 9.7500	87.312 3.4375	.8 .03	5.73 kg 12.64 lb	106.362 4.1875	67790V: MADE FROM VACUUM MELT STEEL
*67787V	174.625 6.8750	47.625 1.8750	3.5 .14	4.72 kg 10.40 lb	67721XD	247.650 9.7500	87.312 3.4375	.8 .03	5.71 kg 12.59 lb	106.362 4.1875	67791D: ASYMMETRICAL BEARING SHOULDER ON OD RIGHTFACE
67790	177.800 7.0000	47.625 1.8750	3.5 .14	4.35 kg 9.58 lb	*67725-B	247.650 9.7500	41.275 1.6250	3.3 .13	3.34 kg 7.37 lb	14.288 .5625	67791DGW: ASYMMETRICAL BEARING GROOVE IN ID SHOULDER ON OD RIGHTFACE SLOTS IN LEFTFACE
*67790V	177.800 7.0000	47.625 1.8750	3.5 .14	4.35 kg 9.58 lb							
67791	177.800 7.0000	47.625 1.8750	10.5 .41	4.13 kg 9.11 lb							
*67782DW	168.275 6.6250	92.075 3.6250	1.5 .06	12.58 kg 27.75 lb	67720	247.650 9.7500	38.100 1.5000	3.3 .13	2.29 kg 5.05 lb	90.488 3.5625	67791DW: ASYMMETRICAL BEARING SHOULDER ON OD RIGHTFACE SLOTS IN LEFTFACE
67790D	177.800 7.0000	90.488 3.5625	1.5 .06	10.67 kg 23.53 lb	*67720V	247.650 9.7500	38.100 1.5000	3.3 .13	2.29 kg 5.05 lb	90.488 3.5625	
*67790TD	177.800 7.0000	90.488 3.5625	1.5 .06	11.41 kg 25.17 lb							NA67791-SW: FRONTFACE CHAMFER SLOTS IN FRONTFACE
*67791D	177.800 7.0000	92.075 3.6250	1.5 .06	10.73 kg 23.65 lb							67720-B : FLANGE ON OD FRONTFACE, BEARING WIDTH IS T1 DIMENSION
*67791DGW	177.800 7.0000	92.075 3.6250	1.5 .06	10.71 kg 23.61 lb							67720CD : GROOVE IN OD CENTER HOLES IN OD CENTER
*67791DW	177.800 7.0000	92.075 3.6250	1.5 .06	10.71 kg 23.61 lb							67720DW : GROOVE IN OD CENTER HOLES IN OD CENTER
											67720V : MADE FROM VACUUM MELT STEEL
											67721D : GROOVE IN OD CENTER HOLES IN OD CENTER
											67725-B : FLANGE ON OD FRONTFACE, BEARING WIDTH IS T1 DIMENSION
NA67787	174.625 6.8750	51.595 2.0313	3.5 .14	9.73 kg 21.46 lb	*67720CD	247.650 9.7500	84.138 3.3125	.8 .03	5.41 kg 11.94 lb	103.190 4.0626	
*NA67787W	174.625 6.8750	51.595 2.0313	3.5 .14	9.65 kg 21.27 lb	*67720DW	247.650 9.7500	93.662 3.6875	.8 .03	5.37 kg 11.85 lb	103.190 4.0626	
NA67790	177.800 7.0000	51.595 2.0313	3.5 .14	9.02 kg 19.88 lb	*67721D	247.650 9.7500	87.312 3.4375	.8 .03	5.73 kg 12.64 lb	103.190 4.0626	
NA67790W	177.800 7.0000	51.595 2.0313	3.5 .14	8.93 kg 19.69 lb	67721XD	247.650 9.7500	87.312 3.4375	.8 .03	5.71 kg 12.59 lb	103.190 4.0626	
*NA67791-SW	177.800 7.0000	51.595 2.0313	3.5 .14	8.93 kg 19.69 lb							
<b>67800 Series</b>											
*NA67874-SW	179.974 7.0856	54.767 2.1562	2.5 .10	- -	*67820CD	266.700 10.5000	84.138 3.3125	.8 .03	5.79 kg 12.76 lb	109.535 4.3124	NA67874-SW: EXTENDED LARGE RIB FRONTFACE CHAMFER SLOTS IN FRONTFACE
*NA67885-SW	190.500 7.5000	54.767 2.1562	3.5 .14	- -							67885D: ASYMMETRICAL BEARING SHOULDER ON OD LEFTFACE
67883	184.150 7.2500	46.833 1.8438	3.5 .14	5.95 kg 13.11 lb	*67820-B	266.700 10.5000	38.100 1.5000	3.3 .13	2.76 kg 6.09 lb	16.670 .6563	67885DW: ASYMMETRICAL BEARING SHOULDER ON OD LEFTFACE SLOTS IN RIGHTFACE
67884	187.325 7.3750	46.833 1.8438	3.5 .14	5.61 kg 12.37 lb	67820	266.700 10.5000	38.100 1.5000	3.3 .13	2.62 kg 5.78 lb	47.625 1.8750	
67885	190.500 7.5000	46.833 1.8438	3.5 .14	5.26 kg 11.60 lb	*67820CD	266.700 10.5000	84.138 3.3125	.8 .03	5.79 kg 12.76 lb	103.188 4.0625	
67887	192.088 7.5625	46.833 1.8438	10.5 .41	4.86 kg 10.71 lb	67830	280.000 11.0236	36.000 1.4173	3.3 .13	4.08 kg 8.99 lb	46.525 1.8317	NA67885-SW: EXTENDED LARGE RIB FRONTFACE CHAMFER SLOTS IN FRONTFACE

67800 SERIES CONTINUED ON NEXT PAGE

\*\*These Maximum Fillet Radii will be cleared by the Cone or Cup Radii.  
†Bore or O.D. shown are maximum dimensions. \*See Remarks Column.



5

CONE			Max Shaft Fillet Radii R''	Weight	CUP			Max Hs'ng Fillet Radii r''	Weight	BEARING	Remarks
Number	BORE d	WIDTH B			Number	OUTSIDE DIA D	WIDTH C			WIDTH T	
<b>67800 Series (cont)</b>											
67888	194.976 7.6762	46.833 1.8438	3.5 .14	4.77 kg 10.51 lb	67835	289.992 11.4170	36.000 1.4173	3.3 .13	5.33 kg 11.76 lb	46.525 1.8317	67820-B : FLANGE ON OD FRONTFACE, BEARING WIDTH IS T1 DIMENSION 67820CD : GROOVE IN OD CENTER HOLES IN OD CENTER
67890H	190.500 7.5000	50.000 1.9685	3.5 .14	5.57 kg 12.28 lb							
67891H	192.088 7.5625	50.000 1.9685	3.5 .14	5.38 kg 11.87 lb							
*67885D	190.500 7.5000	89.695 3.5313	1.5 .06	12.49 kg 27.55 lb	67820	266.700 10.5000	38.100 1.5000	3.3 .13	2.62 kg 5.78 lb	90.488 3.5625	
*67885DW	190.500 7.5000	89.695 3.5313	1.5 .06	12.46 kg 27.47 lb	67830	280.000 11.0236	36.000 1.4173	3.3 .13	4.08 kg 8.99 lb	88.288 3.4759	
					67835	289.992 11.4170	36.000 1.4173	3.3 .13	5.33 kg 11.76 lb	88.288 3.4759	
67875	180.000 7.0866	46.000 1.8110	6.4 .25	6.23 kg 13.73 lb	67875 and grouped cones may be paired with all single cups corresponding to 67883 and will require -.526 mm (-.0207 in) to be added to the T-width values.						
67886	190.078 7.4834	46.000 1.8110	6.4 .25	5.19 kg 11.44 lb	67875 and grouped cones may be paired with all double cups corresponding to 67883 and will require -1.052 mm (-.0414 in) to be added to the T-width values.						
<b>67900 Series</b>											
*67980TD	198.438 7.8125	87.312 3.4375	.8 .03	15.60 kg 34.41 lb	67919	279.400 11.0000	36.512 1.4375	3.3 .13	2.39 kg 5.28 lb	87.312 3.4375	67980TD: TAPERED BORE NA67983-SW: FRONTFACE CHAMFER SLOTS IN FRONTFACE
67985D	206.375 8.1250	87.312 3.4375	.8 .03	13.16 kg 29.02 lb	67920	282.575 11.1250	36.512 1.4375	3.3 .13	2.79 kg 6.15 lb	87.312 3.4375	
*67986D	206.375 8.1250	90.488 3.5625	.8 .03	13.24 kg 29.19 lb	*67920V	282.575 11.1250	36.512 1.4375	3.3 .13	2.79 kg 6.15 lb	87.312 3.4375	67986D: ASYMMETRICAL BEARING SHOULDER ON OD RIGHTFACE 67986DVH: ASYMMETRICAL BEARING MADE FROM VACUUM MELT STEEL SHOULDER ON OD RIGHTFACE
*67986DVH	206.375 8.1250	90.488 3.5625	.8 .03	13.24 kg 29.19 lb							
*67986DW	206.375 8.1250	90.488 3.5625	.8 .03	13.20 kg 29.11 lb							
67981	198.298 7.8070	49.212 1.9375	3.5 .14	6.71 kg 14.79 lb	67919	279.400 11.0000	36.512 1.4375	3.3 .13	2.39 kg 5.28 lb	46.038 1.8125	67986DW: ASYMMETRICAL BEARING SHOULDER ON OD RIGHTFACE SLOTS IN LEFTFACE
67982	199.949 7.8720	49.212 1.9375	3.5 .14	6.51 kg 14.35 lb	67920	282.575 11.1250	36.512 1.4375	3.3 .13	2.79 kg 6.15 lb	46.038 1.8125	
67983	203.200 8.0000	46.038 1.8125	3.5 .14	5.96 kg 13.15 lb	*67920-B	282.575 11.1250	36.512 1.4375	3.3 .13	2.97 kg 6.55 lb	16.670 .6563	67920-B : FLANGE ON OD FRONTFACE, BEARING WIDTH IS T1 DIMENSION
67983W	203.200 8.0000	46.038 1.8125	3.5 .14	5.86 kg 12.93 lb	*67920CD	282.575 11.1250	82.550 3.2500	.8 .03	6.63 kg 14.61 lb	101.600 4.0000	67920CD : GROOVE IN OD CENTER HOLES IN OD CENTER
67985	206.375 8.1250	46.038 1.8125	3.5 .14	5.60 kg 12.34 lb	*67920D	282.575 11.1250	82.550 3.2500	.8 .03	6.63 kg 14.61 lb	101.600 4.0000	67920D : GROOVE IN OD CENTER HOLES IN OD CENTER
67987	206.375 8.1250	49.212 1.9375	3.5 .14	5.84 kg 12.89 lb	*67920DC	282.575 11.1250	82.550 3.2500	.8 .03	6.63 kg 14.61 lb	101.600 4.0000	
67989	209.550 8.2500	46.038 1.8125	3.5 .14	5.22 kg 11.51 lb	*67920V	282.575 11.1250	36.512 1.4375	3.3 .13	2.79 kg 6.15 lb	46.038 1.8125	67920DC : HOLES IN OD CENTER
67989H	209.550 8.2500	49.212 1.9375	3.5 .14	5.43 kg 11.96 lb	*67921D	282.575 11.1250	88.900 3.5000	.8 .03	6.83 kg 15.05 lb	107.950 4.2500	67920V : MADE FROM VACUUM MELT STEEL 67921D : GROOVE IN OD CENTER HOLES IN OD CENTER 67921DV : GROOVE IN OD CENTER HOLES IN OD CENTER MADE FROM VACUUM MELT STEEL
					*67921DV	282.575 11.1250	88.900 3.5000	.8 .03	6.83 kg 15.05 lb	107.950 4.2500	
NA67983	203.200 8.0000	50.800 2.0000	3.5 .14	12.57 kg 27.71 lb	*67920CD	282.575 11.1250	82.550 3.2500	.8 .03	6.63 kg 14.61 lb	101.600 4.0000	
*NA67983-SW	203.200 8.0000	50.800 2.0000	3.5 .14	12.45 kg 27.45 lb	*67920D	282.575 11.1250	82.550 3.2500	.8 .03	6.63 kg 14.61 lb	101.600 4.0000	
					*67920DC	282.575 11.1250	82.550 3.2500	.8 .03	6.63 kg 14.61 lb	101.600 4.0000	
					*67921D	282.575 11.1250	88.900 3.5000	.8 .03	6.83 kg 15.05 lb	101.600 4.0000	
					*67921DV	282.575 11.1250	88.900 3.5000	.8 .03	6.83 kg 15.05 lb	101.600 4.0000	

\*\*These Maximum Fillet Radii will be cleared by the Cone or Cup Radii.  
†Bore or O.D. shown are maximum dimensions. \*See Remarks Column.

68000 – 71000 SERIES

5

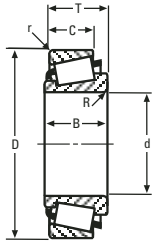

SINGLE ROW



SINGLE ROW WITH FLANGE

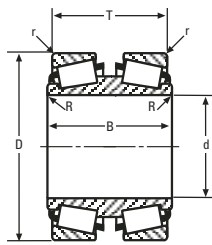

DOUBLE CONE

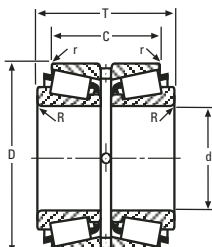

DOUBLE CUP

CONE			Max Shaft Fillet Radii R <sup>**</sup>	Weight	CUP			Max H's'ng Fillet Radii r <sup>**</sup>	Weight	BEARING	Remarks
Number	BORE d	WIDTH B			Number	OUTSIDE DIA D	WIDTH C			WIDTH T	
<b>68000 Series</b>											
68450	114.300 4.5000	31.750 1.2500	3.5 .14	1.85 kg 4.08 lb	68709	179.974 7.0856	25.400 1.0000	.8 .03	1.00 kg 2.20 lb	34.925 1.3750	68450A: SPECIAL FRONTFACE RADIUS
*68450A	114.300 4.5000	31.750 1.2500	3.5 .14	1.85 kg 4.07 lb	*68712-B	180.975 7.1250	25.400 1.0000	3.3 .13	1.16 kg 2.55 lb	16.670 .6563	68712-B : FLANGE ON OD FRONTFACE, BEARING WIDTH IS T1 DIMENSION
68462	117.475 4.6250	31.750 1.2500	3.5 .14	1.71 kg 3.76 lb	*68712RB	180.975 7.1250	25.400 1.0000	3.3 .13	1.05 kg 2.32 lb	34.925 1.3750	68712RB : GROOVE IN OD FRONTFACE
68463	117.475 4.6250	31.750 1.2500	8.0 .31	1.63 kg 3.60 lb	68712	180.975 7.1250	25.400 1.0000	3.3 .13	1.03 kg 2.28 lb	34.925 1.3750	
					68726	184.150 7.2500	28.971 1.1406	3.3 .13	1.37 kg 3.03 lb	37.278 1.4676	
<b>L68100 Series</b>											
*†JL68145	35.000 1.3780	18.461 .7268	2.0 .08	.12 kg .27 lb	L68110	59.131 2.3280	11.938 4.700	1.3 .05	.06 kg .12 lb	15.875 .6250	JL68145: EXTENDED SMALL RIB
*L68149	34.988 1.3775	16.764 .6600	spcl. spcl.	.11 kg .24 lb	†JL68111-Z	60.000 2.3622	11.938 4.700	1.3 .05	.06 kg .14 lb	15.875 .6250	L68149: SPECIAL BACKFACE RADIUS
L68149A	34.988 1.3775	16.764 .6600	.8 .03	.12 kg .26 lb	L68111	59.974 2.3612	11.938 4.700	1.3 .05	.06 kg .14 lb	15.875 .6250	L68149H: SPECIAL BACKFACE RADIUS
*L68149H	34.988 1.3775	16.764 .6600	spcl. spcl.	.11 kg .24 lb	L68111P	59.974 2.3612	11.938 4.700	1.3 .05	.06 kg .14 lb	15.875 .6250	L68149P: SPECIAL BACKFACE RADIUS
*L68149P	34.988 1.3775	16.764 .6600	spcl. spcl.	.11 kg .24 lb	L68116	65.088 2.5625	11.938 4.700	1.3 .05	.11 kg .25 lb	15.875 .6250	
<b>69000 Series</b>											
69350X	88.900 3.5000	30.162 1.1875	2.3 .09	1.61 kg 3.55 lb	69630	160.096 6.3030	22.300 .8780	3.3 .13	.80 kg 1.77 lb	30.124 1.1860	
69354	89.992 3.5430	30.162 1.1875	2.3 .09	1.57 kg 3.47 lb							
<b>L69300 Series</b>											
*†JL69345	38.000 1.4961	19.000 .7480	spcl. spcl.	.13 kg .29 lb	†JL69310	63.000 2.4803	13.500 .5315	1.5 .05	.07 kg .16 lb	17.000 .6693	JL69345: EXTENDED SMALL RIB SPECIAL BACKFACE RADIUS
†JL69348	38.000 1.4961	17.000 .6693	3.3 .13	.13 kg .30 lb	†JL69310E	63.000 2.4803	15.500 .6102	.5 .02	.09 kg .19 lb	18.912 .7446	JL69349: SPECIAL BACKFACE RADIUS
*†JL69349	38.000 1.4961	17.000 .6693	spcl. spcl.	.13 kg .30 lb	†JL69310P	63.000 2.4803	13.500 .5315	1.5 .05	.07 kg .16 lb	17.000 .6693	JL69349P: SPECIAL BACKFACE RADIUS
†JL69349A	38.000 1.4961	17.000 .6693	1.3 .05	.14 kg .30 lb	†JL69310-Z	63.000 2.4803	13.500 .5315	1.3 .05	.07 kg .16 lb	17.000 .6693	
†JL69349AX	38.000 1.4961	17.000 .6693	.5 .01	.14 kg .30 lb							
†JL69349CP	38.000 1.4961	17.000 .6693	3.3 .13	.13 kg .30 lb							
†JL69349H	38.000 1.4961	17.000 .6693	3.0 .13	.13 kg .30 lb							
*†JL69349P	38.000 1.4961	17.000 .6693	spcl. spcl.	.13 kg .28 lb							
†JL69349X	38.000 1.4961	17.000 .6693	2.3 .09	.14 kg .30 lb							
<b>71000 Series</b>											
71373	94.948 3.7381	49.500 1.9488	4.0 .16	4.66 kg 10.28 lb	71750	190.500 7.5000	34.925 1.3750	3.3 .13	1.72 kg 3.79 lb	47.625 1.8750	71457TD: TAPERED BORE
71412	104.775 4.1250	49.212 1.9375	3.5 .14	4.06 kg 8.95 lb	*71750-B	190.500 7.5000	34.925 1.3750	3.3 .13	1.88 kg 4.14 lb	20.638 .8125	71750-B : FLANGE ON OD FRONTFACE, BEARING WIDTH IS T1 DIMENSION
71425	107.950 4.2500	49.212 1.9375	3.5 .14	3.85 kg 8.50 lb	*71751D	190.500 7.5000	80.962 3.1875	1.5 .06	4.03 kg 8.89 lb	106.362 4.1875	71751D : GROOVE IN OD CENTER HOLES IN OD CENTER
71425W	107.950 4.2500	49.212 1.9375	3.5 .14	3.77 kg 8.32 lb	*71751DC	190.500 7.5000	80.962 3.1875	1.5 .06	4.03 kg 8.89 lb	106.362 4.1875	71751DC : HOLES IN OD CENTER
71432	109.952 4.3288	49.212 1.9375	3.5 .14	3.72 kg 8.21 lb	71753	191.976 7.5581	34.925 1.3750	3.3 .13	1.84 kg 4.06 lb	47.625 1.8750	
71433X	110.000 4.3307	49.212 1.9375	3.5 .14	3.72 kg 8.20 lb	71788	199.974 7.8730	36.800 1.4488	4.0 .16	2.67 kg 5.89 lb	49.500 1.9488	
71437	111.125 4.3750	49.212 1.9375	3.5 .14	3.64 kg 8.03 lb							
71437W	111.125 4.3750	49.212 1.9375	3.5 .14	3.61 kg 7.97 lb							

71000 SERIES CONTINUED ON NEXT PAGE

\*\*These Maximum Fillet Radii will be cleared by the Cone or Cup Radii.  
†Bore or O.D. shown are maximum dimensions. \*See Remarks Column.

5

CONE			Max Shaft Fillet Radii R <sup>**</sup>	Weight	CUP			Max Hs'ng Fillet Radii r <sup>**</sup>	Weight	BEAR-ING	Remarks
Number	BORE d	WIDTH B			Number	OUTSIDE DIA D	WIDTH C			WIDTH T	
<b>71000 Series (cont)</b>											
71450	114.300 4.5000	49.212 1.9375	3.5 .14	3.43 kg 7.56 lb							
71450W	114.300 4.5000	49.212 1.9375	3.5 .14	3.44 kg 7.60 lb							
71451	114.300 4.5000	49.212 1.9375	3.5 .14	3.41 kg 7.52 lb							
71453	115.087 4.5310	49.212 1.9375	3.5 .14	3.37 kg 7.43 lb							
71455	115.087 4.5310	49.212 1.9375	8.0 .31	3.30 kg 7.27 lb							
71426D	107.950 4.2500	101.600 4.0000	1.5 .06	9.76 kg 21.52 lb	71750	190.500 7.5000	34.925 1.3750	3.3 .13	1.72 kg 3.79 lb	98.425 3.8750	
71450D	114.300 4.5000	101.600 4.0000	1.5 .06	8.88 kg 19.57 lb	71753	191.976 7.5581	34.925 1.3750	3.3 .13	1.84 kg 4.06 lb	98.425 3.8750	
					71788	199.974 7.8730	36.800 1.4488	4.0 .16	2.67 kg 5.89 lb	102.174 4.0226	
NA71450	114.300 4.5000	53.183 2.0938	3.5 .14	7.04 kg 15.53 lb	*71751D	190.500 7.5000	80.962 3.1875	1.5 .06	4.03 kg 8.89 lb	106.365 4.1876	
					*71751DC	190.500 7.5000	80.962 3.1875	1.5 .06	4.03 kg 8.89 lb	106.365 4.1876	
*71457TD	115.888 4.5625	111.125 4.3750	1.5 .06	9.66 kg 21.30 lb	71457TD may be paired with all single cups corresponding to 71426D and will require 9.525 mm (.3750 in) to be added to the T-width values.						
<b>72000 Series</b>											
*72187	47.625 1.8750	32.791 1.2910	3.5 .14	1.29 kg 2.85 lb	*72487-B	123.825 4.8750	25.400 1.0000	3.3 .13	.90 kg 1.99 lb	17.462 .6875	72187: FRONTFACE CHAMFER
72188	47.625 1.8750	32.791 1.2910	.8 .03	1.30 kg 2.87 lb	72487	123.825 4.8750	25.400 1.0000	3.3 .13	.78 kg 1.72 lb	36.512 1.4375	72200: FRONTFACE CHAMFER
*72200	50.800 2.0000	32.791 1.2910	3.5 .14	1.23 kg 2.71 lb	*72488D	123.825 4.8750	55.562 2.1875	1.5 .06	1.66 kg 3.67 lb	77.787 3.0625	72212: FRONTFACE CHAMFER
*72212	53.975 2.1250	32.791 1.2910	3.5 .14	1.16 kg 2.56 lb	72500	127.000 5.0000	25.400 1.0000	3.3 .13	.90 kg 1.99 lb	36.512 1.4375	72487-B : FLANGE ON OD FRONTFACE, BEARING WIDTH IS T1 DIMENSION
72218	55.562 2.1875	32.791 1.2910	3.5 .14	1.13 kg 2.49 lb	*72500D	127.000 5.0000	57.023 2.2450	.8 .03	2.01 kg 4.43 lb	79.248 3.1200	72488D : GROOVE IN OD CENTER HOLES IN OD CENTER
72225	57.150 2.2500	32.791 1.2910	3.5 .14	1.09 kg 2.41 lb							72500D : GROOVE IN OD CENTER HOLES IN OD CENTER
NA72212	53.975 2.1250	38.892 1.5312	2.3 .09	- -	*72488D	123.825 4.8750	55.562 2.1875	1.5 .06	1.66 kg 3.67 lb	77.785 3.0624	
					*72500D	127.000 5.0000	57.023 2.2450	.8 .03	2.01 kg 4.43 lb	77.785 3.0624	
<b>72000C Series</b>											
72187C	47.625 1.8750	32.791 1.2910	3.5 .14	1.45 kg 3.20 lb	72487	123.825 4.8750	25.400 1.0000	3.3 .13	.78 kg 1.72 lb	36.512 1.4375	72488D : GROOVE IN OD CENTER HOLES IN OD CENTER
72188C	47.625 1.8750	32.791 1.2910	.8 .03	1.48 kg 3.26 lb	*72488D	123.825 4.8750	55.562 2.1875	1.5 .06	1.66 kg 3.67 lb	77.786 3.0624	72500D : GROOVE IN OD CENTER HOLES IN OD CENTER
72200C	50.800 2.0000	32.791 1.2910	3.5 .14	1.42 kg 3.12 lb	72500	127.000 5.0000	25.400 1.0000	3.3 .13	.90 kg 1.99 lb	36.512 1.4375	
72201C	50.800 2.0000	32.791 1.2910	.8 .03	1.42 kg 3.12 lb	*72500D	127.000 5.0000	57.023 2.2450	.8 .03	2.01 kg 4.43 lb	79.246 3.1199	
72212C	53.975 2.1250	32.791 1.2910	3.5 .14	1.35 kg 2.97 lb							
72213C	53.975 2.1250	32.791 1.2910	3.5 .14	1.35 kg 2.97 lb							
72218C	55.562 2.1875	32.791 1.2910	3.5 .14	1.31 kg 2.89 lb							
72219C	55.562 2.1875	32.791 1.2910	3.5 .14	1.31 kg 2.89 lb							
72225C	57.150 2.2500	32.791 1.2910	3.5 .14	1.28 kg 2.81 lb							

\*\*These Maximum Fillet Radii will be cleared by the Cone or Cup Radii.  
†Bore or O.D. shown are maximum dimensions. \*See Remarks Column.

72000C – 74000 SERIES

5

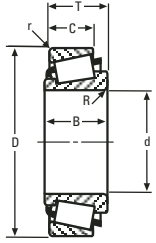

SINGLE ROW



SINGLE ROW WITH FLANGE

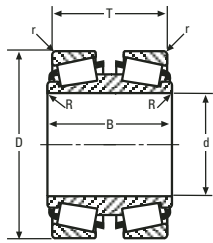

DOUBLE CONE

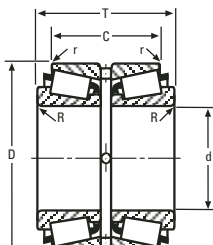

DOUBLE CUP

CONE			Max Shaft Fillet Radii R <sup>**</sup>	Weight	CUP			Max Hs'ng Fillet Radii r <sup>**</sup>	Weight	BEARING WIDTH T	Remarks
Number	BORE d	WIDTH B			Number	OUTSIDE DIA D	WIDTH C				
<b>72000C Series (cont)</b>											
NA72212C	53.975	38.892	2.3	*72488D	123.825	55.562	1.5	1.66 kg	77.785		
	2.1250	1.5312	.09		4.8750	2.1875	.06	3.67 lb	3.0624		
				*72500D	127.000	57.023	.8	2.01 kg	77.785		
					5.0000	2.2450	.03	4.43 lb	3.0624		
<b>LM72800 Series</b>											
LM72849	22.606	15.500	1.5	LM72810	47.000	12.000	1.0	.05 kg	15.500		
	.8900	.6102	.06		1.8504	.4724	.04	.10 lb	.6102		
LM72849F	22.606	15.500	1.5								
	.8900	.6102	.06								
<b>73000 Series</b>											
73550D	139.700	53.975	3.5	73875	222.250	23.812	3.3	1.43 kg	60.579	73876CD : GROOVE IN OD CENTER HOLES IN OD CENTER	
	5.5000	2.1250	.14		8.7500	.9375	.13	3.15 lb	2.3850		
73551	139.700	31.623	3.5	73875	222.250	23.812	3.3	1.43 kg	34.925		
	5.5000	1.2450	.14		8.7500	.9375	.13	3.15 lb	1.3750		
73562	142.875	31.623	3.5	*73876CD	222.250	53.975	2.3	3.24 kg	75.700		
	5.6250	1.2450	.14		8.7500	2.1250	.09	7.13 lb	2.9803		
<b>74000 Series</b>											
74472	119.964	47.625	3.5	74845	214.975	34.925	3.3	1.84 kg	47.625	74537-SW : SLOTS IN BACKFACE	
	4.7230	1.8750	.14		8.4636	1.3750	.13	4.06 lb	1.8750	74539TD : ASYMMETRICAL BEARING TAPERED BORE	
74473X	120.000	47.625	4.0	*74845-B	214.975	34.925	3.3	2.01 kg	20.638	74550V : MADE FROM VACUUM MELT STEEL	
	4.7244	1.8750	.16		8.4636	1.3750	.13	4.43 lb	.8125		
74500	127.000	47.625	3.5	74846X	215.000	34.925	3.3	1.84 kg	47.625	74845-B : FLANGE ON OD FRONTFACE, BEARING WIDTH IS T1 DIMENSION	
	5.0000	1.8750	.14		8.4646	1.3750	.13	4.06 lb	1.8750		
74511X	130.000	47.625	3.5	74849XD	215.900	80.962	1.5	4.73 kg	106.363	74850-B : FLANGE ON OD FRONTFACE, BEARING WIDTH IS T1 DIMENSION	
	5.1181	1.8750	.14		8.5000	3.1875	.06	10.43 lb	4.1875		
74525	133.350	47.625	3.5	74850	215.900	34.925	3.3	1.95 kg	47.625	74850W : KEYWAY IN OD BACKFACE	
	5.2500	1.8750	.14		8.5000	1.3750	.13	4.29 lb	1.8750		
74529	134.976	47.625	3.5	*74850-B	215.900	34.925	3.3	2.13 kg	20.638		
	5.3140	1.8750	.14		8.5000	1.3750	.13	4.69 lb	.8125		
74536W	136.525	47.625	3.5	*74850W	215.900	34.925	3.3	1.94 kg	47.625	74850XX : MADE FROM VACUUM MELT STEEL	
	5.3750	1.8750	.14		8.5000	1.3750	.13	4.28 lb	1.8750		
74537	136.525	47.625	3.5	*74850XX	215.900	34.925	3.3	1.92 kg	47.625	74851CD : GROOVE IN OD CENTER HOLES IN OD CENTER	
	5.3750	1.8750	.14		8.5000	1.3750	.13	4.24 lb	1.8750		
*74537-SW	136.525	47.625	3.5	*74851CD	215.900	80.962	1.5	4.42 kg	106.363	74854V : MADE FROM VACUUM MELT STEEL	
	5.3750	1.8750	.14		8.5000	3.1875	.06	9.75 lb	4.1875		
74550	139.700	47.625	3.5	74851XD	215.900	80.962	1.5	4.85 kg	106.363		
	5.5000	1.8750	.14		8.5000	3.1875	.06	10.70 lb	4.1875		
74550-B	139.700	47.625	3.5	74853	215.900	47.625	3.3	2.62 kg	53.975		
	5.5000	1.8750	.14		8.5000	1.8750	.13	5.78 lb	2.1250		
74550A	139.700	47.625	6.4	*74854V	215.900	34.925	3.3	1.94 kg	47.507		
	5.5000	1.8750	.25		8.5000	1.3750	.13	4.29 lb	1.8704		
*74550V	139.700	47.625	3.5	74856	217.488	34.925	3.3	2.07 kg	47.625		
	5.5000	1.8750	.14		8.5625	1.3750	.13	4.57 lb	1.8750		
74550W	139.700	47.625	3.5								
	5.5000	1.8750	.14								
74551X	140.000	47.625	3.5								
	5.5118	1.8750	.14								
74556	139.974	47.625	3.5								
	5.5108	1.8750	.14								
74510D	130.005	123.825	1.5	74845	214.975	34.925	3.3	1.84 kg	123.825		
	5.1183	4.8750	.06		8.4636	1.3750	.13	4.06 lb	4.8750		
*74539TD	136.525	123.825	1.5	74846X	215.000	34.925	3.3	1.84 kg	123.825		
	5.3750	4.8750	.06		8.4646	1.3750	.13	4.06 lb	4.8750		
				74850	215.900	34.925	3.3	1.95 kg	123.825		
					8.5000	1.3750	.13	4.29 lb	4.8750		
				*74850W	215.900	34.925	3.3	1.94 kg	123.825		
					8.5000	1.3750	.13	4.28 lb	4.8750		
				*74850XX	215.900	34.925	3.3	1.92 kg	123.825		
					8.5000	1.3750	.13	4.24 lb	4.8750		
				74853	215.900	47.625	3.3	2.62 kg	136.525		
					8.5000	1.8750	.13	5.78 lb	5.3750		
				*74854V	215.900	34.925	3.3	1.94 kg	123.825		
					8.5000	1.3750	.13	4.29 lb	4.8750		

74000 SERIES CONTINUED ON NEXT PAGE

\*\*These Maximum Fillet Radii will be cleared by the Cone or Cup Radii.  
†Bore or O.D. shown are maximum dimensions. \*See Remarks Column.

CONE			Max Shaft Fillet Radii R''	Weight	CUP			Max Hs'ng Fillet Radii r''	Weight	BEARING	Remarks
Number	BORE d	WIDTH B			Number	OUTSIDE DIA D	WIDTH C			WIDTH T	
<b>74000 Series (cont)</b>											
					<b>74856</b>	<b>217.488</b> 8.5625	<b>34.925</b> 1.3750	<b>3.3</b> .13	<b>2.07 kg</b> 4.57 lb	<b>123.825</b> 4.8750	
<b>74555A</b>	<b>139.700</b> 5.5000	<b>53.183</b> 2.0938	<b>12.7</b> .50	<b>3.89 kg</b> 8.58 lb	<b>74845</b>	<b>214.975</b> 8.4636	<b>34.925</b> 1.3750	<b>3.3</b> .13	<b>1.84 kg</b> 4.06 lb	<b>47.625</b> 1.8750	
					<b>*74845-B</b>	<b>214.975</b> 8.4636	<b>34.925</b> 1.3750	<b>3.3</b> .13	<b>2.01 kg</b> 4.43 lb	<b>20.638</b> .8125	
					<b>74846X</b>	<b>215.000</b> 8.4646	<b>34.925</b> 1.3750	<b>3.3</b> .13	<b>1.84 kg</b> 4.06 lb	<b>47.625</b> 1.8750	
					<b>74850</b>	<b>215.900</b> 8.5000	<b>34.925</b> 1.3750	<b>3.3</b> .13	<b>1.95 kg</b> 4.29 lb	<b>47.625</b> 1.8750	
					<b>*74850-B</b>	<b>215.900</b> 8.5000	<b>34.925</b> 1.3750	<b>3.3</b> .13	<b>2.13 kg</b> 4.69 lb	<b>20.638</b> .8125	
					<b>*74850W</b>	<b>215.900</b> 8.5000	<b>34.925</b> 1.3750	<b>3.3</b> .13	<b>1.94 kg</b> 4.28 lb	<b>47.625</b> 1.8750	
					<b>*74850XX</b>	<b>215.900</b> 8.5000	<b>34.925</b> 1.3750	<b>3.3</b> .13	<b>1.92 kg</b> 4.24 lb	<b>47.625</b> 1.8750	
					<b>74853</b>	<b>215.900</b> 8.5000	<b>47.625</b> 1.8750	<b>3.3</b> .13	<b>2.62 kg</b> 5.78 lb	<b>53.975</b> 2.1250	
					<b>*74854V</b>	<b>215.900</b> 8.5000	<b>34.925</b> 1.3750	<b>3.3</b> .13	<b>1.94 kg</b> 4.29 lb	<b>47.507</b> 1.8704	
					<b>74856</b>	<b>217.488</b> 8.5625	<b>34.925</b> 1.3750	<b>3.3</b> .13	<b>2.07 kg</b> 4.57 lb	<b>47.625</b> 1.8750	
<b>74512D</b>	<b>130.175</b> 5.1250	<b>101.600</b> 4.0000	<b>1.5</b> .06	<b>12.40 kg</b> 27.34 lb	74512D may be paired with all single cups corresponding to 74510D and will require -.22.225 mm (-.8750 in) to be added to the T-width values.						
<b>NA74525</b>	<b>133.350</b> 5.2500	<b>53.183</b> 2.0938	<b>3.5</b> .14	<b>9.59 kg</b> 21.15 lb	<b>74849XD</b>	<b>215.900</b> 8.5000	<b>80.962</b> 3.1875	<b>1.5</b> .06	<b>4.73 kg</b> 10.43 lb	<b>106.365</b> 4.1876	
					<b>*74851CD</b>	<b>215.900</b> 8.5000	<b>80.962</b> 3.1875	<b>1.5</b> .06	<b>4.42 kg</b> 9.75 lb	<b>106.365</b> 4.1876	
					<b>74851XD</b>	<b>215.900</b> 8.5000	<b>80.962</b> 3.1875	<b>1.5</b> .06	<b>4.85 kg</b> 10.70 lb	<b>106.365</b> 4.1876	
<b>74555</b>	<b>139.700</b> 5.5000	<b>53.183</b> 2.0938	<b>12.7</b> .50	<b>3.89 kg</b> 8.58 lb	74555 may be paired with all single cups corresponding to 74555A and will require -.114 mm (-.0045 in) to be added to the T-width values.						
<b>74555D</b>	<b>139.700</b> 5.5000	<b>106.362</b> 4.1875	<b>1.5</b> .06	<b>10.08 kg</b> 22.22 lb	74555D may be paired with all single cups corresponding to 74510D and will require -.29.185 mm (-1.1490 in) to be added to the T-width values.						
<b>77000 Series</b>											
<b>77350</b>	<b>88.900</b> 3.5000	<b>48.260</b> 1.9000	<b>5.0</b> .20	<b>3.34 kg</b> 7.36 lb	<b>*77675-B</b>	<b>171.450</b> 6.7500	<b>38.100</b> 1.5000	<b>3.3</b> .13	<b>1.83 kg</b> 4.03 lb	<b>17.462</b> .6875	<b>77675-B : FLANGE ON OD FRONTFACE, BEARING WIDTH IS T1 DIMENSION</b>
<b>77362</b>	<b>92.075</b> 3.6250	<b>48.260</b> 1.9000	<b>3.5</b> .14	<b>3.18 kg</b> 7.01 lb	<b>77675</b>	<b>171.450</b> 6.7500	<b>38.100</b> 1.5000	<b>3.3</b> .13	<b>1.65 kg</b> 3.64 lb	<b>47.625</b> 1.8750	<b>77676-BW : FLANGE ON OD FRONTFACE, BEARING WIDTH IS T1 DIMENSION</b>
<b>77364</b>	<b>92.075</b> 3.6250	<b>48.260</b> 1.9000	<b>6.4</b> .25	<b>3.15 kg</b> 6.94 lb	<b>*77676-BW</b>	<b>171.450</b> 6.7500	<b>53.183</b> 2.0938	<b>3.3</b> .13	<b>2.42 kg</b> 5.33 lb	<b>10.320</b> .4063	<b>KEYWAY IN OD SURFACE</b>
<b>77375</b>	<b>95.250</b> 3.7500	<b>48.260</b> 1.9000	<b>3.5</b> .14	<b>3.00 kg</b> 6.62 lb	<b>77676X</b>	<b>171.450</b> 6.7500	<b>41.275</b> 1.6250	<b>3.3</b> .13	<b>1.85 kg</b> 4.07 lb	<b>50.800</b> 2.0000	<b>77676W : KEYWAY IN OD SURFACE THREADED OD FRONTFACE</b>
<b>77376</b>	<b>95.250</b> 3.7500	<b>48.260</b> 1.9000	<b>6.4</b> .25	<b>2.97 kg</b> 6.55 lb	<b>*77676W</b>	<b>171.450</b> 6.7500	<b>57.150</b> 2.2500	<b>3.3</b> .13	<b>2.39 kg</b> 5.28 lb	<b>55.563</b> 2.1875	
<b>78000 Series</b>											
<b>78214</b>	<b>53.975</b> 2.1250	<b>33.236</b> 1.3085	<b>.8</b> .03	<b>1.74 kg</b> 3.83 lb	<b>78537</b>	<b>136.525</b> 5.3750	<b>23.520</b> .9260	<b>3.3</b> .13	<b>.76 kg</b> 1.68 lb	<b>36.513</b> 1.4375	<b>78549D : GROOVE IN OD CENTER HOLES IN OD CENTER</b>
<b>78215</b>	<b>53.975</b> 2.1250	<b>33.236</b> 1.3085	<b>3.5</b> .14	<b>1.73 kg</b> 3.82 lb	<b>*78549D</b>	<b>139.700</b> 5.5000	<b>51.803</b> 2.0395	<b>1.5</b> .06	<b>1.95 kg</b> 4.30 lb	<b>77.788</b> 3.0625	<b>78551DF : HOLES IN OD CENTER</b>
<b>78225</b>	<b>57.150</b> 2.2500	<b>33.236</b> 1.3085	<b>3.5</b> .14	<b>1.66 kg</b> 3.66 lb	<b>78551</b>	<b>140.030</b> 5.5130	<b>23.520</b> .9260	<b>2.3</b> .09	<b>.92 kg</b> 2.02 lb	<b>36.513</b> 1.4375	<b>K93494 : ASYMMETRICAL - TWO SERIES BEARING</b>
<b>78238</b>	<b>60.325</b> 2.3750	<b>33.236</b> 1.3085	<b>5.0</b> .20	<b>1.57 kg</b> 3.47 lb	<b>*78551DF</b>	<b>139.954</b> 5.5100	<b>51.803</b> 2.0395	<b>1.5</b> .06	<b>2.00 kg</b> 4.41 lb	<b>77.788</b> 3.0625	<b>GROOVE IN OD LEFTFACE HOLES IN OD CENTER</b>
<b>78250</b>	<b>63.500</b> 2.5000	<b>33.236</b> 1.3085	<b>2.3</b> .09	<b>1.51 kg</b> 3.32 lb	<b>78571</b>	<b>144.983</b> 5.7080	<b>23.007</b> .9058	<b>3.5</b> .14	<b>1.07 kg</b> 2.36 lb	<b>36.000</b> 1.4173	
<b>78255X</b>	<b>64.988</b> 2.5586	<b>32.923</b> 1.2962	<b>3.5</b> .14	<b>1.46 kg</b> 3.22 lb							
<b>78216D</b>	<b>54.988</b> 2.1649	<b>65.989</b> 2.5980	<b>2.3</b> .09	<b>3.99 kg</b> 8.79 lb	<b>78537</b>	<b>136.525</b> 5.3750	<b>23.520</b> .9260	<b>3.3</b> .13	<b>.76 kg</b> 1.68 lb	<b>66.091</b> 2.6020	

\*\*These Maximum Fillet Radii will be cleared by the Cone or Cup Radii.  
†Bore or O.D. shown are maximum dimensions. \*See Remarks Column.

78000 – 81000 SERIES

5

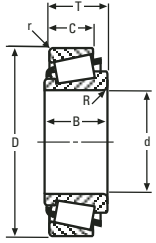

SINGLE ROW



SINGLE ROW WITH FLANGE

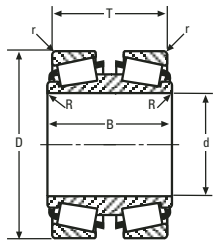

DOUBLE CONE

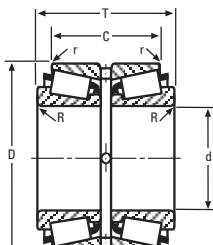

DOUBLE CUP

CONE			Max Shaft Fillet Radii R <sup>**</sup>	Weight	CUP			Max Hs'ng Fillet Radii r <sup>**</sup>	Weight	BEARING WIDTH T	Remarks
Number	BORE d	WIDTH B			Number	OUTSIDE DIA D	WIDTH C				
<b>78000 Series (cont)</b>											
78251D	63.500 2.5000	65.989 2.5980	2.3 .09	3.55 kg 7.83 lb	78551	140.030 5.5130	23.520 .9260	2.3 .09	.92 kg 2.02 lb	66.091 2.6020	
78255D	64.988 2.5586	65.989 2.5980	1.5 .06	3.54 kg 7.81 lb	78571	144.983 5.7080	23.007 .9058	3.5 .14	1.07 kg 2.36 lb	65.065 2.5616	
NA78250	63.500 2.5000	38.892 1.5312	2.3 .09	3.19 kg 7.03 lb	*78549D	139.700 5.5000	51.803 2.0395	1.5 .06	1.95 kg 4.30 lb	77.785 3.0624	
					*78551DF	139.954 5.5100	51.803 2.0395	1.5 .06	2.00 kg 4.41 lb	77.785 3.0624	
					*K93494	139.903 5.5080	52.095 2.0510	1.5 .06	2.34 kg 5.17 lb	77.785 3.0624	
<b>78000C Series</b>											
78214C	53.975 2.1250	33.236 1.3085	.8 .03	1.84 kg 4.05 lb	*78513-B	130.198 5.1259	23.520 .9260	2.3 .09	.63 kg 1.38 lb	19.993 .7871	78513-B : FLANGE ON OD FRONTFACE, BEARING WIDTH IS T1 DIMENSION
78215C	53.975 2.1250	33.236 1.3085	3.5 .14	1.83 kg 4.04 lb	78537	136.525 5.3750	23.520 .9260	3.3 .13	.76 kg 1.68 lb	36.513 1.4375	
78225C	57.150 2.2500	33.236 1.3085	3.5 .14	1.76 kg 3.88 lb	78551	140.030 5.5130	23.520 .9260	2.3 .09	.92 kg 2.02 lb	36.513 1.4375	
78238C	60.325 2.3750	33.236 1.3085	5.0 .20	1.67 kg 3.68 lb							
78248C	63.500 2.5000	33.236 1.3085	.8 .03	1.61 kg 3.56 lb							
78250AC	63.500 2.5000	33.236 1.3085	5.0 .20	1.59 kg 3.51 lb							
<b>LM78300 Series</b>											
*LM78349	34.988 1.3775	17.000 .6693	3.5 .14	.12 kg .27 lb	LM78310A	61.973 2.4399	13.600 .5354	1.5 .06	.07 kg .16 lb	16.702 .6576	
LM78349A	34.988 1.3775	17.000 .6693	1.5 .06	.13 kg .29 lb	LM78310C	61.973 2.4399	15.000 .5906	1.5 .06	.08 kg .18 lb	18.053 .7107	LM78349: SPECIAL BACKFACE RADIUS
<b>80000 Series</b>											
80170	431.800 17.0000	44.450 1.7500	3.3 .13	19.44 kg 42.86 lb	80217	552.450 21.7500	31.750 1.2500	3.3 .13	5.87 kg 12.93 lb	44.448 1.7499	
80176	447.675 17.6250	44.450 1.7500	3.3 .13	15.63 kg 34.45 lb	80222	565.150 22.2500	31.750 1.2500	3.3 .13	8.63 kg 19.03 lb	44.448 1.7499	
80180	457.200 18.0000	44.450 1.7500	3.3 .13	13.26 kg 29.25 lb							
<b>80300 Series</b>											
80385	431.800 17.0000	46.038 1.8125	3.3 .13	13.86 kg 30.55 lb	*80325-B	533.400 21.0000	34.925 1.3750	3.3 .13	7.28 kg 16.06 lb	20.638 .8125	80325-B : FLANGE ON OD FRONTFACE, BEARING WIDTH IS T1 DIMENSION
					80325	533.400 21.0000	34.925 1.3750	3.3 .13	6.76 kg 14.90 lb	46.038 1.8125	
<b>80400 Series</b>											
80480	482.600 19.0000	46.038 1.8125	3.3 .13	20.91 kg 46.10 lb	80418	596.900 23.5000	41.275 1.6250	3.3 .13	8.07 kg 17.79 lb	53.975 2.1250	
80487	501.650 19.7500	46.038 1.8125	3.3 .13	15.64 kg 34.48 lb	80425	615.950 24.2500	41.275 1.6250	3.3 .13	13.90 kg 30.64 lb	53.975 2.1250	
<b>80700 Series</b>											
80780	635.000 25.0000	53.975 2.1250	3.3 .13	23.23 kg 51.21 lb	80720	736.600 29.0000	41.275 1.6250	3.3 .13	11.16 kg 24.61 lb	57.150 2.2500	
<b>81000 Series</b>											
*NA81550	139.700 5.5000	53.975 2.1250	3.5 .14	13.75 kg 30.31 lb	*81963CD	244.475 9.6250	79.375 3.1250	1.5 .06	5.48 kg 12.09 lb	107.950 4.2500	NA81550: EXTENDED SMALL RIB
*NA81600	152.400 6.0000	53.975 2.1250	3.5 .14	11.28 kg 24.86 lb							81575: EXTENDED SMALL RIB SHOULDER ON OD FRONTFACE
											81576D: EXTENDED SMALL RIB
*81575	146.050 5.7500	50.005 1.9687	3.5 .14	5.90 kg 13.01 lb	81962	244.475 9.6250	33.338 1.3125	3.3 .13	2.31 kg 5.10 lb	47.625 1.8750	81577DW: EXTENDED SMALL RIB
*81590	150.000 5.9055	50.005 1.9687	3.5 .14	5.58 kg 12.31 lb	81962X	244.475 9.6250	41.275 1.6250	3.3 .13	2.66 kg 5.87 lb	47.498 1.8700	KEYWAY IN ID RIGHTSIDE
*81593	150.812 5.9375	50.005 1.9687	3.5 .14	5.51 kg 12.15 lb	*81963CD	244.475 9.6250	79.375 3.1250	1.5 .06	5.48 kg 12.09 lb	107.950 4.2500	81590: EXTENDED SMALL RIB SHOULDER ON OD FRONTFACE
*81600	152.400 6.0000	50.005 1.9687	3.5 .14	5.35 kg 11.79 lb	81964	245.000 9.6457	33.338 1.3125	3.3 .13	2.36 kg 5.20 lb	47.625 1.8750	81593: EXTENDED SMALL RIB SHOULDER ON OD FRONTFACE

81000 SERIES CONTINUED ON NEXT PAGE

\*\*These Maximum Fillet Radii will be cleared by the Cone or Cup Radii.  
†Bore or O.D. shown are maximum dimensions. \*See Remarks Column.

CONE			Max Shaft Fillet Radii R''	Weight	CUP			Max Hs'ng Fillet Radii r''	Weight	BEARING	Remarks
Number	BORE d	WIDTH B			Number	OUTSIDE DIA D	WIDTH C			WIDTH T	
<b>81000 Series (cont)</b>											
*81606	153.988 6.0625	50.005 1.9687	3.5 .14	5.31 kg 11.71 lb							
*81629	159.951 6.2973	50.005 1.9687	3.5 .14	4.73 kg 10.44 lb							81600: EXTENDED SMALL RIB SHOULDER ON OD FRONTFACE
81630	159.951 6.2973	46.830 1.8437	3.5 .14	4.59 kg 10.13 lb							NA81600: EXTENDED SMALL RIB
81637	161.925 6.3750	46.830 1.8437	3.5 .14	4.41 kg 9.72 lb							81601D: EXTENDED SMALL RIB
*81576D	146.050 5.7500	92.075 3.6250	1.5 .06	12.94 kg 28.52 lb	81962	244.475 9.6250	33.338 1.3125	3.3 .13	2.31 kg 5.10 lb	87.312 3.4375	81602DW: EXTENDED SMALL RIB KEYWAY IN ID RIGHTSIDE
*81577DW	146.050 5.7500	92.075 3.6250	3.3 .13	12.94 kg 28.52 lb	81962X	244.475 9.6250	41.275 1.6250	3.3 .13	2.66 kg 5.87 lb	87.058 3.4275	81604TD: TAPERED BORE
*81601D	152.400 6.0000	92.075 3.6250	1.5 .06	11.90 kg 26.25 lb	81964	245.000 9.6457	33.338 1.3125	3.3 .13	2.36 kg 5.20 lb	87.312 3.4375	81606: EXTENDED SMALL RIB SHOULDER ON OD FRONTFACE
*81602DW	152.400 6.0000	92.075 3.6250	1.5 .06	11.90 kg 26.25 lb							81629: EXTENDED SMALL RIB SHOULDER ON OD FRONTFACE 81963CD : GROOVE IN OD CENTER HOLES IN OD CENTER
*81604TD	152.400 6.0000	119.062 4.6875	1.5 .06	16.56 kg 36.52 lb	81604TD may be paired with all single cups corresponding to 81576D and will require 33.338 mm (1.3125 in) to be added to the T-width values.						
<b>HM81600 Series</b>											
HM81649	15.987 .6294	21.000 .8268	1.0 .04	.11 kg .24 lb	HM81610	46.975 1.8494	16.000 .6299	2.0 .08	.08 kg .17 lb	21.000 .8268	
<b>82000 Series</b>											
82550	139.700 5.5000	56.642 2.2300	3.5 .14	6.84 kg 15.09 lb	82931	236.538 9.3125	44.450 1.7500	3.3 .13	3.03 kg 6.68 lb	57.150 2.2500	82581TD: ASYMMETRICAL BEARING TAPERED BORE
82562	142.875 5.6250	56.642 2.2300	3.5 .14	6.53 kg 14.40 lb	*82932D	236.538 9.3125	106.362 4.1875	1.5 .06	7.49 kg 16.52 lb	131.763 5.1875	82587TD: ASYMMETRICAL BEARING TAPERED BORE
82562A	142.875 5.6250	56.642 2.2300	8.0 .31	6.44 kg 14.20 lb	*82932DC	236.538 9.3125	106.362 4.1875	1.5 .06	7.49 kg 16.52 lb	131.763 5.1875	82587X: KEYWAY IN BACKFACE
82576	146.050 5.7500	56.642 2.2300	3.5 .14	6.21 kg 13.70 lb	†J82945	240.000 9.4488	44.450 1.7500	3.3 .13	3.50 kg 7.72 lb	57.150 2.2500	82932D : GROOVE IN OD CENTER HOLES IN OD CENTER
82587	149.225 5.8750	56.642 2.2300	3.5 .14	5.88 kg 12.98 lb	82950	241.300 9.5000	44.450 1.7500	3.3 .13	3.65 kg 8.05 lb	57.150 2.2500	
*82587X	149.225 5.8750	56.642 2.2300	3.5 .14	5.81 kg 12.81 lb	*82950-B	241.300 9.5000	44.450 1.7500	3.3 .13	4.17 kg 9.19 lb	22.225 .8750	82932DC : HOLES IN OD CENTER 82950-B : FLANGE ON OD FRONTFACE, BEARING WIDTH IS T1 DIMENSION
					*82951CD	241.300 9.5000	106.362 4.1875	1.5 .06	8.85 kg 19.52 lb	131.763 5.1875	82951CD : GROOVE IN OD CENTER HOLES IN OD CENTER
82587D	149.225 5.8750	105.347 4.1475	1.5 .06	14.26 kg 31.44 lb	82931	236.538 9.3125	44.450 1.7500	3.3 .13	3.03 kg 6.68 lb	106.362 4.1875	
*82587TD	149.225 5.8750	105.347 4.1475	1.5 .06	15.13 kg 33.36 lb	†J82945	240.000 9.4488	44.450 1.7500	3.3 .13	3.50 kg 7.72 lb	106.362 4.1875	
					82950	241.300 9.5000	44.450 1.7500	3.3 .13	3.65 kg 8.05 lb	106.362 4.1875	
NA82576	146.050 5.7500	65.883 2.5938	3.5 .14	13.19 kg 29.09 lb	*82932D	236.538 9.3125	106.362 4.1875	1.5 .06	7.49 kg 16.52 lb	131.765 5.1876	
NA82587	149.225 5.8750	65.883 2.5938	3.5 .14	12.43 kg 27.41 lb	*82932DC	236.538 9.3125	106.362 4.1875	1.5 .06	7.49 kg 16.52 lb	131.765 5.1876	
					*82951CD	241.300 9.5000	106.362 4.1875	1.5 .06	8.85 kg 19.52 lb	131.765 5.1876	
*82581TD	147.638 5.8125	132.334 5.2100	1.5 .06	17.98 kg 39.65 lb	82581TD may be paired with all single cups corresponding to 82587D and will require 26.988 mm (1.0625 in) to be added to the T-width values.						
<b>82600 Series</b>											
82680D	177.800 7.0000	112.712 4.4375	1.5 .06	19.78 kg 43.63 lb	82620	279.400 11.0000	43.655 1.7187	3.3 .13	4.56 kg 10.06 lb	112.710 4.4374	82620D : GROOVE IN OD CENTER HOLES IN OD CENTER
82681D	177.800 7.0000	112.712 4.4375	1.5 .06	19.78 kg 43.63 lb	82622	273.050 10.7500	43.655 1.7187	3.3 .13	3.62 kg 7.99 lb	112.710 4.4374	

†These Maximum Fillet Radii will be cleared by the Cone or Cup Radii.  
†Bore or O.D. shown are maximum dimensions. \*See Remarks Column.

82600 – 86000 SERIES

5

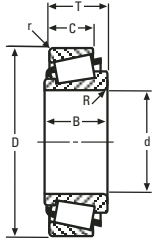

SINGLE ROW

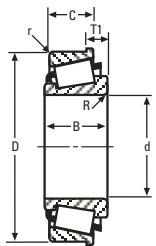

SINGLE ROW WITH FLANGE

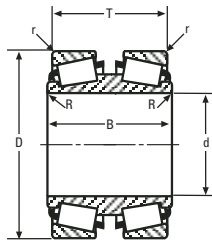

DOUBLE CONE

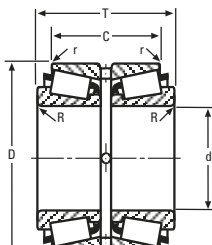

DOUBLE CUP

CONE			Max Shaft Fillet Radii R <sup>**</sup>	Weight	CUP			Max Hs'ng Fillet Radii r <sup>**</sup>	Weight	BEARING WIDTH T	Remarks
Number	BORE d	WIDTH B			Number	OUTSIDE DIA D	WIDTH C				
<b>82600 Series (cont)</b>											
*82681DGW	177.800 7.0000	112.712 4.4375	1.5 .06	18.96 kg 41.81 lb							82681DGW: GROOVE IN ID 82622D : GROOVE IN OD CENTER HOLES IN OD CENTER
82680X	177.800 7.0000	61.912 2.4375	3.3 .13	8.52 kg 18.78 lb	82620 279.400 11.0000	43.655 1.7187	3.3 .13	4.56 kg 10.06 lb	61.913 2.4375		
					*82620D 279.400 11.0000	96.838 3.8125	1.5 .06	10.57 kg 23.30 lb	133.353 5.2501		
					82622 273.050 10.7500	43.655 1.7187	3.3 .13	3.62 kg 7.99 lb	61.913 2.4375		
					*82622D 273.050 10.7500	96.838 3.8125	1.5 .06	8.50 kg 18.75 lb	133.353 5.2501		
<b>82700 Series</b>											
*82786TD	190.236 7.4896	158.750 6.2500	1.6 .06	28.24 kg 62.26 lb	82720 288.925 11.3750	42.862 1.6875	3.3 .13	4.27 kg 9.42 lb	158.750 6.2500		82785TD: TAPERED BORE 82786TD: TAPERED BORE
*82789TD	193.675 7.6250	158.750 6.2500	3.2 .12	27.10 kg 59.76 lb	82722 284.162 11.1875	42.862 1.6875	3.3 .13	3.56 kg 7.84 lb	158.750 6.2500		82789TD: TAPERED BORE 82720-B : FLANGE ON OD FRONTFACE, BEARING WIDTH IS T1 DIMENSION
82788	190.500 7.5000	55.562 2.1875	3.5 .14	8.11 kg 17.89 lb	*82720-B 288.925 11.3750	42.862 1.6875	3.3 .13	4.72 kg 10.42 lb	22.225 .8750		
					82720 288.925 11.3750	42.862 1.6875	3.3 .13	4.27 kg 9.42 lb	55.562 2.1875		
					82722 284.162 11.1875	42.862 1.6875	3.3 .13	3.56 kg 7.84 lb	55.562 2.1875		
*82785TD	190.236 7.4896	111.125 4.3750	1.5 .06	21.22 kg 46.80 lb	82785TD may be paired with all single cups corresponding to 82786TD and will require -.47.625 mm (-1.8750 in) to be added to the T-width values.						
<b>84000 Series</b>											
*84111W	282.575 11.1250	50.800 2.0000	3.5 .14	12.64 kg 27.87 lb	84155 393.700 15.5000	44.450 1.7500	6.4 .25	6.95 kg 15.33 lb	63.500 2.5000		84111W: KEYWAY IN BACKFACE 84117T: TAPERED BORE
84115	292.100 11.5000	50.800 2.0000	3.5 .14	11.07 kg 24.42 lb							
*84117T	296.334 11.6667	50.800 2.0000	1.5 .06	10.84 kg 23.90 lb							
<b>M84200 Series</b>											
M84249	25.400 1.0000	23.114 .9100	.8 .03	.20 kg .44 lb	M84210 59.530 2.3437	18.288 .7200	1.5 .06	.13 kg .28 lb	23.368 .9200		
<b>M84500 Series</b>											
*M84548	25.400 1.0000	19.431 .7650	1.5 .06	.15 kg .34 lb	M84510 57.150 2.2500	14.732 .5800	1.5 .06	.09 kg .19 lb	19.431 .7650		M84548: FRONTFACE CHAMFER M84549: FRONTFACE CHAMFER
*M84549	26.988 1.0625	19.431 .7650	1.5 .06	.14 kg .31 lb							
<b>85000 Series</b>											
85499	127.000 5.0000	53.180 2.0937	1.5 .06	4.34 kg 9.57 lb	85845 214.312 8.4375	36.512 1.4375	3.3 .13	2.29 kg 5.06 lb	49.205 1.9372		
<b>86000 Series</b>											
86650	165.100 6.5000	46.038 1.8125	4.8 .19	5.23 kg 11.54 lb	86100 254.000 10.0000	33.338 1.3125	3.3 .13	2.35 kg 5.18 lb	46.038 1.8125		86100-B : FLANGE ON OD FRONTFACE, BEARING WIDTH IS T1 DIMENSION SPECIAL RADIUS ON BACKFACE OD
86669	170.000 6.6929	46.038 1.8125	4.8 .19	4.77 kg 10.51 lb	*86100-B 254.000 10.0000	33.338 1.3125	spcl. spcl.	2.76 kg 6.08 lb	22.225 .8750		
86675	171.450 6.7500	46.038 1.8125	4.8 .19	4.66 kg 10.29 lb	*86100W 254.000 10.0000	33.338 1.3125	3.3 .13	2.35 kg 5.18 lb	46.038 1.8125		86100W : KEYWAY IN OD BACKFACE
					86100XD 254.000 10.0000	76.200 3.0000	1.5 .06	5.75 kg 12.68 lb	101.600 4.0000		
					86105 266.700 10.5000	33.338 1.3125	1.5 .06	3.70 kg 8.17 lb	46.038 1.8125		
86650D	165.100 6.5000	101.600 4.0000	1.5 .06	13.60 kg 29.98 lb	86100 254.000 10.0000	33.338 1.3125	3.3 .13	2.35 kg 5.18 lb	92.075 3.6250		
					*86100W 254.000 10.0000	33.338 1.3125	3.3 .13	2.35 kg 5.18 lb	92.075 3.6250		
					86105 266.700 10.5000	33.338 1.3125	1.5 .06	3.70 kg 8.17 lb	92.075 3.6250		

86000 SERIES CONTINUED ON NEXT PAGE

\*\*These Maximum Fillet Radii will be cleared by the Cone or Cup Radii.  
†Bore or O.D. shown are maximum dimensions. \*See Remarks Column.



CONE			Max Shaft Fillet Radii R''	Weight	CUP			Max Hs'ng Fillet Radii r''	Weight	BEAR-ING	Remarks	
Number	BORE d	WIDTH B			Number	OUTSIDE DIA D	WIDTH C			WIDTH T		
<b>86000 Series (cont)</b>												
NA86650	165.100 6.5000	50.800 2.0000	3.5 .14	10.70 kg 23.59 lb	86100XD	254.000 10.0000	76.200 3.0000	1.5 .06	5.75 kg 12.68 lb	101.600 4.0000		
<b>M86600 Series</b>												
M86643	25.400 1.0000	21.433 .8438	1.5 .06	.24 kg .54 lb	M86610	64.292 2.5312	16.670 .6563	1.5 .06	.13 kg .28 lb	21.432 .8438	M86611-B : FLANGE ON OD FRONTFACE, BEARING WIDTH IS T1 DIMENSION	
M86647	28.575 1.1250	21.433 .8438	1.5 .06	.22 kg .49 lb	M86610CP	64.292 2.5312	16.670 .6563	1.5 .06	.13 kg .28 lb	21.432 .8438		
M86648	30.955 1.2187	21.433 .8438	2.3 .09	.20 kg .45 lb	M86610P	64.292 2.5312	16.670 .6563	1.5 .06	.13 kg .28 lb	21.432 .8438		
M86648A	30.955 1.2187	21.433 .8438	1.5 .06	.20 kg .45 lb	*M86611-B	64.292 2.5312	16.670 .6563	1.5 .06	.15 kg .33 lb	8.763 .3450		
M86649	30.162 1.1875	21.433 .8438	1.5 .06	.21 kg .46 lb								
M86649-SP	30.162 1.1875	21.433 .8438	1.5 .06	- -								
M86649C	30.162 1.1875	21.433 .8438	1.5 .06	.21 kg .46 lb								
M86649H	30.162 1.1875	21.433 .8438	1.5 .06	- -								
M86649P	30.162 1.1875	21.433 .8438	1.5 .06	.21 kg .46 lb								
<b>87000 Series</b>												
NA87700	177.800 7.0000	53.975 2.1250	3.5 .14	16.47 kg 36.31 lb	*87112D	282.575 11.1250	79.375 3.1250	1.5 .06	6.91 kg 15.23 lb	107.950 4.2500	NA87700-SW: FRONTFACE CHAMFER SLOTS IN FRONTFACE	
*NA87700-SW	177.800 7.0000	53.975 2.1250	3.5 .14	16.10 kg 35.51 lb	*87112DC	282.575 11.1250	79.375 3.1250	1.5 .06	7.42 kg 16.37 lb	107.950 4.2500	87750C: HOLES IN BACKFACE TO UNDERCUT 87750XX: MADE FROM VACUUM MELT STEEL	
87737	187.325 7.3750	47.625 1.8750	3.5 .14	6.65 kg 14.66 lb	87111	282.575 11.1250	36.512 1.4375	3.3 .13	3.13 kg 6.90 lb	50.800 2.0000	87111-B : FLANGE ON OD FRONTFACE, BEARING WIDTH IS T1 DIMENSION	
87750	190.500 7.5000	47.625 1.8750	3.5 .14	6.30 kg 13.88 lb	*87111-B	282.575 11.1250	36.512 1.4375	3.3 .13	3.53 kg 7.78 lb	23.812 .9375		
*87750C	190.500 7.5000	47.625 1.8750	3.5 .14	6.31 kg 13.92 lb	*87111XX	282.575 11.1250	36.512 1.4375	3.3 .13	3.13 kg 6.90 lb	50.800 2.0000	87111XX: MADE FROM VACUUM MELT STEEL	
*87750XX	190.500 7.5000	47.625 1.8750	3.5 .14	6.24 kg 13.76 lb	*87112D	282.575 11.1250	79.375 3.1250	1.5 .06	6.91 kg 15.23 lb	107.950 4.2500	87112D : GROOVE IN OD CENTER HOLES IN OD CENTER	
87762	193.675 7.6250	47.625 1.8750	3.5 .14	5.94 kg 13.10 lb	*87112DC	282.575 11.1250	79.375 3.1250	1.5 .06	7.42 kg 16.37 lb	107.950 4.2500	87112DC : HOLES IN OD CENTER	
<b>88000 Series</b>												
88900	228.600 9.0000	49.212 1.9375	6.4 .25	8.10 kg 17.86 lb	88126	320.675 12.6250	33.338 1.3125	3.3 .13	2.96 kg 6.54 lb	50.800 2.0000	88919T: TAPERED BORE	
*88919T	233.362 9.1875	49.212 1.9375	1.5 .06	7.52 kg 16.59 lb	88128	327.025 12.8750	34.925 1.3750	3.3 .13	4.04 kg 8.91 lb	52.388 2.0625	88129-B : FLANGE ON OD FRONTFACE, BEARING WIDTH IS T1 DIMENSION	
88925	234.950 9.2500	49.212 1.9375	6.4 .25	7.21 kg 15.90 lb	*88129-B	328.612 12.9375	34.925 1.3750	3.3 .13	4.68 kg 10.31 lb	26.988 1.0625		
88931	236.538 9.3125	44.450 1.7500	3.5 .14	6.50 kg 14.34 lb	88931 and grouped cones may be paired with all single cups corresponding to 88900 and will require -6.350 mm (-.2500 in) to be added to the T-width values.							
88931H	236.538 9.3125	44.450 1.7500	3.5 .14	6.40 kg 14.11 lb								
<b>M88000 Series</b>												
M88036	25.400 1.0000	22.225 .8750	.8 .03	.30 kg .65 lb	*M88010-B	68.262 2.6875	17.462 .6875	1.5 .06	.17 kg .38 lb	8.730 .3437	M88010-B : FLANGE ON OD FRONTFACE, BEARING WIDTH IS T1 DIMENSION	
M88040	28.575 1.1250	22.225 .8750	2.3 .09	.27 kg .60 lb	M88010	68.262 2.6875	17.462 .6875	1.5 .06	.14 kg .32 lb	22.225 .8750		
M88040A	28.575 1.1250	22.225 .8750	.3 .01	.27 kg .60 lb	M88011	68.262 2.6875	17.462 .6875	2.3 .09	.14 kg .31 lb	22.225 .8750		
M88043	30.162 1.1875	22.225 .8750	2.3 .09	.26 kg .57 lb	M88012	68.262 2.6875	17.462 .6875	.8 .03	.15 kg .32 lb	22.225 .8750		
M88044	30.162 1.1875	22.225 .8750	3.8 .15	.26 kg .56 lb	M88018	73.025 2.8750	17.462 .6875	3.3 .13	.21 kg .46 lb	22.225 .8750		
M88045	30.955 1.2187	22.225 .8750	1.5 .06	.25 kg .56 lb	M88022	76.200 3.0000	17.462 .6875	.8 .03	.27 kg .60 lb	22.225 .8750		

\*\*These Maximum Fillet Radii will be cleared by the Cone or Cup Radii.  
†Bore or O.D. shown are maximum dimensions. \*See Remarks Column.

M88000 – HM89400 SERIES

5

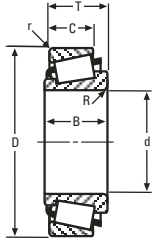

SINGLE ROW



SINGLE ROW WITH FLANGE

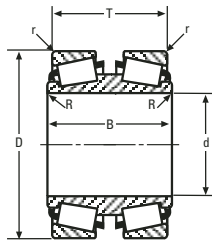

DOUBLE CONE

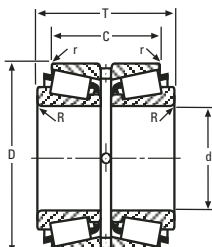

DOUBLE CUP

CONE			Max Shaft Fillet Radii R <sup>**</sup>	Weight	CUP			Max Hs'ng Fillet Radii r <sup>**</sup>	Weight	BEARING WIDTH T	Remarks	
Number	BORE d	WIDTH B			Number	OUTSIDE DIA D	WIDTH C					
<b>M88000 Series (cont)</b>												
M88046	31.750 1.2500	22.225 .8750	1.5 .06	.25 kg .54 lb								
M88047	33.338 1.3125	22.225 .8750	5.5 .22	.22 kg .48 lb								
M88048	33.338 1.3125	22.225 .8750	.8 .03	.24 kg .52 lb								
M88048-S	33.338 1.3125	22.225 .8750	4.0 .16	.23 kg .51 lb								
M88048A	33.338 1.3125	22.225 .8750	1.3 .05	.24 kg .52 lb								
<b>HM88500 Series</b>												
†JHM88540	30.000 1.1811	27.783 1.0938	1.3 .05	.40 kg .88 lb	HM88510	73.025 2.8750	23.020 .9063	3.3 .13	.23 kg .52 lb	29.370 1.1563	HM88547V: MADE FROM VACUUM MELT STEEL HM88510V: MADE FROM VACUUM MELT STEEL	
HM88542	31.750 1.2500	27.783 1.0938	1.3 .05	.38 kg .84 lb	*HM88510V	73.025 2.8750	23.020 .9063	3.3 .13	.23 kg .52 lb	29.370 1.1563		
HM88547	33.338 1.3125	27.783 1.0938	.8 .03	.36 kg .80 lb	HM88511	73.025 2.8750	23.020 .9063	.8 .03	.24 kg .54 lb	29.370 1.1563		
*HM88547V	33.338 1.3125	27.783 1.0938	.8 .03	.36 kg .80 lb	HM88512	73.812 2.9060	23.020 .9063	3.3 .13	.25 kg .55 lb	29.370 1.1563		
					†JHM88513	72.000 2.8346	23.020 .9063	3.3 .13	.21 kg .47 lb	29.370 1.1563		
<b>HM88600 Series</b>												
HM88630	25.400 1.0000	25.400 1.0000	.8 .03	-	HM88610	72.233 2.8438	19.842 .7812	2.3 .09	.18 kg .41 lb	25.400 1.0000		
HM88638	31.986 1.2593	25.400 1.0000	3.3 .13	-	HM88610A	72.233 2.8438	19.842 .7812	.8 .03	.19 kg .42 lb	25.400 1.0000		
HM88644	31.750 1.2500	25.400 1.0000	1.5 .06	-	HM88610P	72.233 2.8438	19.842 .7812	2.3 .09	.18 kg .41 lb	25.400 1.0000		
HM88644A	31.750 1.2500	25.400 1.0000	.6 .03	-	HM88611	71.973 2.8336	21.443 .8442	1.5 .06	.21 kg .47 lb	27.000 1.0630		
HM88648	35.717 1.4062	25.400 1.0000	3.5 .14	-	HM88611AS	72.626 2.8593	19.842 .7812	3.3 .13	.19 kg .41 lb	25.400 1.0000		
HM88649	34.925 1.3750	25.400 1.0000	2.3 .09	-	HM88612	73.025 2.8750	20.985 .8262	2.3 .09	.22 kg .48 lb	26.543 1.0450		
HM88649A	34.925 1.3750	25.400 1.0000	3.5 .14	-	HM88613	73.025 2.8750	21.443 .8442	1.5 .06	.23 kg .50 lb	27.000 1.0630		
HM88649C	34.925 1.3750	25.400 1.0000	2.3 .09	-								
HM88649H	34.925 1.3750	25.400 1.0000	2.3 .09	-								
HM88649HP	34.925 1.3750	25.400 1.0000	2.3 .09	-								
<b>89000 Series</b>												
89108D	276.225 10.8750	88.900 3.5000	3.3 .13	24.15 kg 53.26 lb	89148	381.000 15.0000	36.512 1.4375	3.3 .13	5.38 kg 11.87 lb	95.251 3.7501		
89111D	279.578 11.0070	88.900 3.5000	3.3 .13	23.15 kg 51.04 lb	89150	381.000 15.0000	44.450 1.7500	6.4 .25	7.02 kg 15.48 lb	111.126 4.3751		
<b>HM89200 Series</b>												
HM89249	36.512 1.4375	28.829 1.1350	3.5 .14	.44 kg .98 lb	HM89210	79.375 3.1250	22.664 .8923	3.3 .13	.26 kg .56 lb	29.370 1.1563		
<b>HM89400 Series</b>												
HM89440	31.750 1.2500	28.575 1.1250	.8 .03	.44 kg .97 lb	HM89410	76.200 3.0000	23.020 .9063	3.3 .13	.25 kg .55 lb	29.369 1.1563	HM89410-B: FLANGE ON OD FRONT FACE, BEARING WIDTH IS T1 DIMENSION	
HM89443	33.338 1.3125	28.575 1.1250	.8 .03	.42 kg .93 lb	*HM89410-B	76.200 3.0000	23.020 .9063	3.3 .13	.26 kg .58 lb	11.112 .4375		
HM89444	33.338 1.3125	28.575 1.1250	3.8 .15	.42 kg .92 lb	HM89410P	76.200 3.0000	23.020 .9063	3.3 .13	.25 kg .55 lb	29.369 1.1563		
HM89446	34.925 1.3750	28.575 1.1250	3.5 .14	.40 kg .87 lb	HM89411	76.200 3.0000	23.020 .9063	.8 .03	.26 kg .57 lb	29.369 1.1563		
HM89446A	34.925 1.3750	28.575 1.1250	.8 .03	.40 kg .89 lb								
HM89446P	34.925 1.3750	28.575 1.1250	3.5 .14	.40 kg .87 lb								
HM89448	36.512 1.4375	28.575 1.1250	.8 .03	.38 kg .84 lb								

HM89400 SERIES CONTINUED ON NEXT PAGE

\*\*These Maximum Fillet Radii will be cleared by the Cone or Cup Radii.  
†Bore or O.D. shown are maximum dimensions. \*See Remarks Column.

HM89400 – 93000 SERIES

5

CONE			Max Shaft Fillet Radii R''	Weight	CUP			Max Hs'ng Fillet Radii r''	Weight	BEAR-ING	Remarks
Number	BORE d	WIDTH B			Number	OUTSIDE DIA D	WIDTH C			WIDTH T	
HM89400 Series (cont)											
HM89449	36.512 1.4375	28.575 1.1250	3.5 .14	.38 kg .83 lb							
90000 Series											
†J90354	90.000 3.5433	46.038 1.8125	3.5 .14	4.18 kg 9.22 lb	90744	188.912 7.4375	31.750 1.2500	3.3 .13	1.87 kg 4.12 lb	50.800 2.0000	
90381	96.838 3.8125	46.038 1.8125	3.5 .14	3.82 kg 8.42 lb	†J90748	190.000 7.4803	31.750 1.2500	3.3 .13	1.95 kg 4.29 lb	50.800 2.0000	
90334	85.000 3.3465	52.761 2.0772	3.5 .14	4.79 kg 10.56 lb	90334 may be paired with all single cups corresponding to J90354 and will require 2.497 mm (.0983 in) to be added to the T-width values.						
91000 Series											
EE91700D	177.800 7.0000	106.362 4.1875	1.5 .06	19.34 kg 42.64 lb	91112	285.750 11.2500	41.275 1.6250	3.3 .13	4.35 kg 9.60 lb	106.360 4.1874	
*EE91701TD	177.800 7.0000	125.412 4.9375	1.5 .06	20.65 kg 45.53 lb							
EE91702	177.800 7.0000	63.500 2.5000	6.4 .25	9.05 kg 19.96 lb	91112	285.750 11.2500	41.275 1.6250	3.3 .13	4.35 kg 9.60 lb	63.500 2.5000	
					91113XD	285.750 11.2500	92.075 3.6250	1.5 .06	10.49 kg 23.13 lb	136.525 5.3750	
93000 Series											
93708	179.974 7.0856	63.500 2.5000	3.5 .14	15.38 kg 33.90 lb	93125	317.500 12.5000	46.038 1.8125	3.3 .13	5.98 kg 13.18 lb	63.500 2.5000	
93750	190.500 7.5000	63.500 2.5000	4.3 .17	13.84 kg 30.52 lb	*93125-B	317.500 12.5000	46.038 1.8125	3.3 .13	6.48 kg 14.29 lb	28.575 1.1250	
93775	196.850 7.7500	63.500 2.5000	4.3 .17	12.88 kg 28.40 lb	*93125V	317.500 12.5000	46.038 1.8125	3.3 .13	6.00 kg 13.23 lb	63.500 2.5000	
*93778T	203.093 7.9958	63.500 2.5000	4.3 .17	11.99 kg 26.44 lb	93126	317.500 12.5000	50.800 2.0000	3.3 .13	6.88 kg 15.16 lb	68.262 2.6875	
93787	200.025 7.8750	63.500 2.5000	4.3 .17	12.39 kg 27.31 lb	*93127CD	317.500 12.5000	111.125 4.3750	1.5 .06	15.04 kg 33.16 lb	146.050 5.7500	
93800	203.200 8.0000	63.500 2.5000	4.3 .17	11.89 kg 26.21 lb	*93127DW	317.500 12.5000	130.175 5.1250	1.5 .06	16.05 kg 35.39 lb	146.050 5.7500	
93800A	203.200 8.0000	63.500 2.5000	8.0 .31	11.78 kg 25.96 lb	93128XD	319.976 12.5975	111.125 4.3750	1.5 .06	15.73 kg 34.68 lb	146.050 5.7500	
93800W	203.200 8.0000	63.500 2.5000	4.3 .17	11.78 kg 25.98 lb	†J93129A	320.000 12.5984	46.038 1.8125	3.3 .13	6.42 kg 14.17 lb	63.500 2.5000	
93806A	204.788 8.0625	63.500 2.5000	4.3 .17	11.64 kg 25.66 lb							
93812	206.375 8.1250	63.500 2.5000	4.3 .17	11.38 kg 25.09 lb							
93825	209.550 8.2500	63.500 2.5000	4.3 .17	10.87 kg 23.96 lb							
93825A	209.550 8.2500	63.500 2.5000	12.7 .50	10.48 kg 23.11 lb							
*93825V	209.550 8.2500	63.500 2.5000	4.3 .17	10.87 kg 23.96 lb							
*93827T	209.974 8.2667	63.500 2.5000	4.3 .17	10.90 kg 24.03 lb							
93751D	190.500 7.5000	133.350 5.2500	6.4 .25	34.57 kg 76.23 lb	93125	317.500 12.5000	46.038 1.8125	3.3 .13	5.98 kg 13.18 lb	133.350 5.2500	
*93751DW	190.500 7.5000	133.350 5.2500	6.4 .25	34.57 kg 76.23 lb	*93125V	317.500 12.5000	46.038 1.8125	3.3 .13	6.00 kg 13.23 lb	133.350 5.2500	
93788D	199.974 7.8730	133.350 5.2500	6.4 .25	31.54 kg 69.54 lb	93126	317.500 12.5000	50.800 2.0000	3.3 .13	6.88 kg 15.16 lb	142.875 5.6250	
93801D	203.200 8.0000	133.350 5.2500	6.4 .25	29.93 kg 65.99 lb	†J93129A	320.000 12.5984	46.038 1.8125	3.3 .13	6.42 kg 14.17 lb	133.350 5.2500	
NA93800	203.200 8.0000	73.025 2.8750	5.5 .22	24.95 kg 55.02 lb	*93127CD	317.500 12.5000	111.125 4.3750	1.5 .06	15.04 kg 33.16 lb	146.050 5.7500	
*NA93800-SW	203.200 8.0000	73.025 2.8750	5.5 .22	25.32 kg 55.82 lb	*93127DW	317.500 12.5000	130.175 5.1250	1.5 .06	16.05 kg 35.39 lb	146.050 5.7500	

†These Maximum Fillet Radii will be cleared by the Cone or Cup Radii.  
†Bore or O.D. shown are maximum dimensions. \*See Remarks Column.

93000 SERIES CONTINUED ON NEXT PAGE

93000 – 95000 SERIES

5

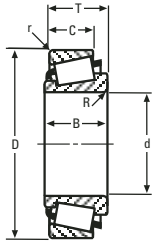

SINGLE ROW



SINGLE ROW WITH FLANGE

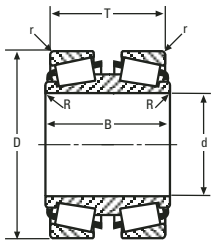

DOUBLE CONE

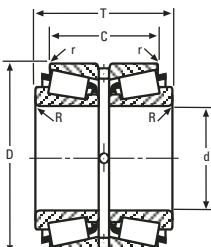

DOUBLE CUP

CONE			Max Shaft Fillet Radii R <sup>**</sup>	Weight	CUP			Max H's'ng Fillet Radii r <sup>**</sup>	Weight	BEAR-ING	Remarks
Number	BORE d	WIDTH B			Number	OUTSIDE DIA D	WIDTH C			WIDTH T	
<b>93000 Series (cont)</b>											
					<b>93128XD</b>	<b>319.976</b> 12.5975	<b>111.125</b> 4.3750	<b>1.5</b> .06	<b>15.73 kg</b> 34.68 lb	<b>146.050</b> 5.7500	
<b>93800D</b>	<b>203.200</b> 8.0000	<b>123.825</b> 4.8750	<b>1.5</b> .06	<b>29.58 kg</b> 65.21 lb	93800D and grouped cones may be paired with all single cups corresponding to 93751D and will require -9.525 mm (-.3750 in) to be added to the T-width values.						
<b>*93800DGW</b>	<b>203.200</b> 8.0000	<b>123.825</b> 4.8750	<b>1.5</b> .06	<b>29.27 kg</b> 64.53 lb							
<b>*93826TD</b>	<b>209.550</b> 8.2500	<b>184.150</b> 7.2500	<b>1.5</b> .06	<b>39.61 kg</b> 87.35 lb	93826TD may be paired with all single cups corresponding to 93751D and will require 50.800 mm (2.0000 in) to be added to the T-width values.						
<b>93500 Series</b>											
<b>93580D</b>	<b>203.200</b> 8.0000	<b>106.362</b> 4.1875	<b>1.5</b> .06	<b>23.77 kg</b> 52.40 lb	<b>93520</b>	<b>317.500</b> 12.5000	<b>39.688</b> 1.5625	<b>3.3</b> .13	<b>5.12 kg</b> 11.29 lb	<b>105.567</b> 4.1562	
<b>93581D</b>	<b>203.200</b> 8.0000	<b>106.362</b> 4.1875	<b>1.5</b> .06	<b>23.77 kg</b> 52.40 lb							
<b>94000 Series</b>											
<b>94649</b>	<b>165.100</b> 6.5000	<b>63.500</b> 2.5000	<b>7.0</b> .28	<b>11.67 kg</b> 25.73 lb	<b>94112XD</b>	<b>288.925</b> 11.3750	<b>114.300</b> 4.5000	<b>1.5</b> .06	<b>15.19 kg</b> 33.50 lb	<b>146.050</b> 5.7500	94650: FRONTFACE CHAMFER
<b>*94650</b>	<b>165.100</b> 6.5000	<b>63.500</b> 2.5000	<b>7.0</b> .28	<b>11.65 kg</b> 25.69 lb	<b>94113</b>	<b>288.925</b> 11.3750	<b>47.625</b> 1.8750	<b>3.3</b> .13	<b>5.32 kg</b> 11.74 lb	<b>63.500</b> 2.5000	94688TD: TAPERED BORE
<b>94669</b>	<b>169.984</b> 6.6923	<b>63.500</b> 2.5000	<b>7.0</b> .28	<b>11.03 kg</b> 24.32 lb	<b>94113A</b>	<b>288.925</b> 11.3750	<b>47.625</b> 1.8750	<b>3.3</b> .13	<b>5.35 kg</b> 11.80 lb	<b>63.500</b> 2.5000	94705TD: ASYMMETRICAL BEARING EXTENDED SMALL RIB
<b>94675</b>	<b>171.450</b> 6.7500	<b>63.500</b> 2.5000	<b>7.0</b> .28	<b>10.83 kg</b> 23.88 lb	<b>*94113-B</b>	<b>288.925</b> 11.3750	<b>47.625</b> 1.8750	<b>3.3</b> .13	<b>5.97 kg</b> 13.16 lb	<b>26.988</b> 1.0625	GROOVE IN OD RIGHTFACE SHOULDER ON OD RIGHTFACE TAPERED BORE
<b>94687</b>	<b>174.625</b> 6.8750	<b>63.500</b> 2.5000	<b>7.0</b> .28	<b>10.40 kg</b> 22.93 lb	<b>*94114CD</b>	<b>288.925</b> 11.3750	<b>111.125</b> 4.3750	<b>1.5</b> .06	<b>12.35 kg</b> 27.24 lb	<b>142.875</b> 5.6250	94713TD: TAPERED BORE
<b>94700</b>	<b>177.800</b> 7.0000	<b>63.500</b> 2.5000	<b>7.0</b> .28	<b>9.96 kg</b> 21.97 lb	<b>*94117D</b>	<b>298.450</b> 11.7500	<b>139.700</b> 5.5000	<b>1.5</b> .06	<b>19.01 kg</b> 41.93 lb	<b>142.875</b> 5.6250	94113-B: FLANGE ON OD FRONTFACE, BEARING WIDTH IS T1 DIMENSION
<b>94700W</b>	<b>177.800</b> 7.0000	<b>63.500</b> 2.5000	<b>7.0</b> .28	<b>9.50 kg</b> 20.94 lb	<b>94118</b>	<b>298.450</b> 11.7500	<b>47.625</b> 1.8750	<b>3.3</b> .13	<b>6.96 kg</b> 15.34 lb	<b>63.500</b> 2.5000	94114CD: GROOVE IN OD CENTER HOLES IN OD CENTER
<b>94703W</b>	<b>177.800</b> 7.0000	<b>63.500</b> 2.5000	<b>7.0</b> .28	<b>9.47 kg</b> 20.89 lb	<b>*94118D</b>	<b>298.450</b> 11.7500	<b>111.125</b> 4.3750	<b>1.5</b> .06	<b>16.80 kg</b> 37.04 lb	<b>142.875</b> 5.6250	94117D: GROOVE IN OD CENTER HOLES IN OD CENTER
					<b>*94122DS</b>	<b>309.562</b> 12.1875	<b>111.125</b> 4.3750	<b>-</b>	<b>21.48 kg</b> 47.36 lb	<b>142.875</b> 5.6250	94118D: GROOVE IN OD CENTER HOLES IN OD CENTER
<b>NA94650</b>	<b>165.100</b> 6.5000	<b>71.438</b> 2.8125	<b>3.5</b> .14	<b>24.87 kg</b> 54.84 lb	<b>94112XD</b>	<b>288.925</b> 11.3750	<b>114.300</b> 4.5000	<b>1.5</b> .06	<b>15.19 kg</b> 33.50 lb	<b>142.875</b> 5.6250	94122DS: HOLES IN OD CENTER
<b>NA94700</b>	<b>177.800</b> 7.0000	<b>71.438</b> 2.8125	<b>5.5</b> .22	<b>20.95 kg</b> 46.20 lb	<b>*94114CD</b>	<b>288.925</b> 11.3750	<b>111.125</b> 4.3750	<b>1.5</b> .06	<b>12.35 kg</b> 27.24 lb	<b>142.875</b> 5.6250	
					<b>*94117D</b>	<b>298.450</b> 11.7500	<b>139.700</b> 5.5000	<b>1.5</b> .06	<b>19.01 kg</b> 41.93 lb	<b>142.875</b> 5.6250	
					<b>*94118D</b>	<b>298.450</b> 11.7500	<b>111.125</b> 4.3750	<b>1.5</b> .06	<b>16.80 kg</b> 37.04 lb	<b>142.875</b> 5.6250	
					<b>*94122DS</b>	<b>309.562</b> 12.1875	<b>111.125</b> 4.3750	<b>-</b>	<b>21.48 kg</b> 47.36 lb	<b>142.875</b> 5.6250	
<b>*94688TD</b>	<b>174.625</b> 6.8750	<b>158.750</b> 6.2500	<b>1.5</b> .06	<b>32.50 kg</b> 71.67 lb	<b>94113</b>	<b>288.925</b> 11.3750	<b>47.625</b> 1.8750	<b>3.3</b> .13	<b>5.32 kg</b> 11.74 lb	<b>158.750</b> 6.2500	
<b>94704D</b>	<b>177.800</b> 7.0000	<b>158.750</b> 6.2500	<b>1.5</b> .06	<b>30.39 kg</b> 67.02 lb	<b>94113A</b>	<b>288.925</b> 11.3750	<b>47.625</b> 1.8750	<b>3.3</b> .13	<b>5.35 kg</b> 11.80 lb	<b>158.750</b> 6.2500	
<b>*94713TD</b>	<b>180.975</b> 7.1250	<b>158.750</b> 6.2500	<b>1.5</b> .06	<b>27.78 kg</b> 61.25 lb	<b>94118</b>	<b>298.450</b> 11.7500	<b>47.625</b> 1.8750	<b>3.3</b> .13	<b>6.96 kg</b> 15.34 lb	<b>158.750</b> 6.2500	
<b>*94705TD</b>	<b>177.800</b> 7.0000	<b>188.912</b> 7.4375	<b>1.5</b> .06	<b>35.35 kg</b> 77.94 lb	94705TD may be paired with all single cups corresponding to 94688TD and will require 6.350 mm (.2500 in) to be added to the T-width values.						
<b>94706D</b>	<b>177.800</b> 7.0000	<b>123.825</b> 4.8750	<b>1.5</b> .06	<b>24.67 kg</b> 54.40 lb	94706D may be paired with all single cups corresponding to 94688TD and will require -34.925 mm (-1.3750 in) to be added to the T-width values.						
<b>95000 Series</b>											
<b>95451D</b>	<b>114.300</b> 4.5000	<b>152.400</b> 6.0000	<b>13.2</b> .52	<b>22.54 kg</b> 49.70 lb	<b>95905</b>	<b>230.000</b> 9.0551	<b>49.212</b> 1.9375	<b>3.3</b> .13	<b>3.31 kg</b> 7.30 lb	<b>139.700</b> 5.5000	95524V: MADE FROM VACUUM MELT STEEL
<b>95474D</b>	<b>120.650</b> 4.7500	<b>152.400</b> 6.0000	<b>6.4</b> .25	<b>21.17 kg</b> 46.69 lb	<b>†J95906</b>	<b>230.000</b> 9.0551	<b>49.723</b> 1.9576	<b>3.3</b> .13	<b>3.39 kg</b> 7.47 lb	<b>139.700</b> 5.5000	95526TD: ASYMMETRICAL BEARING TAPERED BORE
<b>95499D</b>	<b>127.000</b> 5.0000	<b>152.400</b> 6.0000	<b>5.0</b> .20	<b>19.78 kg</b> 43.61 lb	<b>95912</b>	<b>231.775</b> 9.1250	<b>49.212</b> 1.9375	<b>3.3</b> .13	<b>3.58 kg</b> 7.89 lb	<b>139.700</b> 5.5000	95925-B: FLANGE ON OD FRONTFACE, BEARING WIDTH IS T1 DIMENSION

95000 SERIES CONTINUED ON NEXT PAGE

\*\*These Maximum Fillet Radii will be cleared by the Cone or Cup Radii.  
†Bore or O.D. shown are maximum dimensions. \*See Remarks Column.

5

CONE			Max Shaft Fillet Radii R''	Weight	CUP			Max Hs'ng Fillet Radii r''	Weight	BEARING	Remarks	
Number	BORE d	WIDTH B			Number	OUTSIDE DIA D	WIDTH C			WIDTH T		
<b>95000 Series (cont)</b>												
*95526TD	133.350 5.2500	152.400 6.0000	1.5 .06	20.62 kg 45.48 lb	95923V	234.950 9.2500	49.212 1.9375	3.3 .13	4.03 kg 8.88 lb	139.700 5.5000	95927CD : GROOVE IN OD CENTER HOLES IN OD CENTER	
					95925	234.950 9.2500	49.212 1.9375	3.3 .13	4.04 kg 8.91 lb	139.700 5.5000		
					95926	234.950 9.2500	49.212 1.9375	3.3 .13	4.08 kg 8.99 lb	139.700 5.5000		
					95928	234.975 9.2510	49.212 1.9375	3.3 .13	4.01 kg 8.84 lb	139.700 5.5000		
					95929	234.975 9.2510	49.949 1.9665	3.3 .13	4.13 kg 9.11 lb	142.296 5.6022		
					95962	244.475 9.6250	49.212 1.9375	3.3 .13	5.39 kg 11.88 lb	139.700 5.5000		
					95975	247.650 9.7500	49.212 1.9375	3.3 .13	5.86 kg 12.92 lb	139.700 5.5000		
95475	120.650 4.7500	63.500 2.5000	6.4 .25	8.30 kg 18.30 lb	95905	230.000 9.0551	49.212 1.9375	3.3 .13	3.31 kg 7.30 lb	63.500 2.5000		
95491	124.943 4.9190	63.500 2.5000	6.4 .25	7.89 kg 17.39 lb	†J95906	230.000 9.0551	49.723 1.9576	3.3 .13	3.39 kg 7.47 lb	63.500 2.5000		
95500	127.000 5.0000	63.500 2.5000	6.4 .25	7.68 kg 16.94 lb	95912	231.775 9.1250	49.212 1.9375	3.3 .13	3.58 kg 7.89 lb	63.500 2.5000		
95502	127.000 5.0000	68.715 2.7053	9.7 .38	8.22 kg 18.13 lb	95923V	234.950 9.2500	49.212 1.9375	3.3 .13	4.03 kg 8.88 lb	63.500 2.5000		
95506	128.575 5.0620	68.715 2.7053	3.5 .14	7.81 kg 17.22 lb	*95925-B	234.950 9.2500	49.212 1.9375	3.3 .13	4.59 kg 10.12 lb	25.400 1.0000		
95512	129.974 5.1171	63.500 2.5000	6.4 .25	7.39 kg 16.28 lb	95925	234.950 9.2500	49.212 1.9375	3.3 .13	4.04 kg 8.91 lb	63.500 2.5000		
95512X	130.000 5.1181	63.500 2.5000	6.0 .24	7.39 kg 16.29 lb	95926	234.950 9.2500	49.212 1.9375	3.3 .13	4.08 kg 8.99 lb	63.500 2.5000		
95514X	129.967 5.1168	68.715 2.7053	3.3 .13	7.66 kg 16.89 lb	*95927CD	234.950 9.2500	114.300 4.5000	1.5 .06	9.28 kg 20.46 lb	142.875 5.6250		
*95524V	133.350 5.2500	63.500 2.5000	.8 .03	7.36 kg 16.22 lb	95928	234.975 9.2510	49.212 1.9375	3.3 .13	4.01 kg 8.84 lb	63.500 2.5000		
95525	133.350 5.2500	63.500 2.5000	9.7 .38	6.95 kg 15.31 lb	95929	234.975 9.2510	49.949 1.9665	3.3 .13	4.13 kg 9.11 lb	64.798 2.5511		
95527A	133.350 5.2500	63.500 2.5000	13.2 .52	6.80 kg 14.99 lb	95962	244.475 9.6250	49.212 1.9375	3.3 .13	5.39 kg 11.88 lb	63.500 2.5000		
95528	133.350 5.2500	63.500 2.5000	4.8 .19	7.07 kg 15.58 lb	95975	247.650 9.7500	49.212 1.9375	3.3 .13	5.86 kg 12.92 lb	63.500 2.5000		
NA95500	127.000 5.0000	71.438 2.8125	3.5 .14	- -	*95927CD	234.950 9.2500	114.300 4.5000	1.5 .06	9.28 kg 20.46 lb	142.875 5.6250		
<b>96000 Series</b>												
96825	209.550 8.2500	66.675 2.6250	7.0 .28	18.51 kg 40.82 lb	*96140-B	355.600 14.0000	47.625 1.8750	3.3 .13	9.31 kg 20.53 lb	31.750 1.2500	96851DW: KEYWAY IN ID 96876TD: TAPERED BORE	
96900	228.600 9.0000	66.675 2.6250	7.0 .28	15.08 kg 33.26 lb	96140	355.600 14.0000	47.625 1.8750	3.3 .13	8.30 kg 18.31 lb	68.262 2.6875	96877TD: ASYMMETRICAL BEARING GROOVE IN OD LEFTFACE TAPERED BORE	
96925	234.950 9.2500	66.675 2.6250	7.0 .28	13.87 kg 30.59 lb	*96140CD	355.600 14.0000	111.125 4.3750	1.5 .06	18.23 kg 40.19 lb	152.400 6.0000	96140-B : FLANGE ON OD FRONTFACE, BEARING WIDTH IS T1 DIMENSION	
96851D	215.900 8.5000	130.175 5.1250	6.4 .25	41.74 kg 92.04 lb	96140	355.600 14.0000	47.625 1.8750	3.3 .13	8.30 kg 18.31 lb	127.000 5.0000	96140CD : GROOVE IN OD CENTER HOLES IN OD CENTER	
*96851DW	215.900 8.5000	130.175 5.1250	6.4 .25	41.68 kg 91.90 lb								
*96876TD	222.250 8.7500	130.175 5.1250	1.5 .06	41.69 kg 91.94 lb								
*96877TD	222.250 8.7500	171.450 6.7500	1.5 .06	45.02 kg 99.26 lb	96877TD may be paired with all single cups corresponding to 96851D and will require 6.350 mm (.2500 in) to be added to the T-width values.							
<b>97000 Series</b>												
97450	114.300 4.5000	49.428 1.9460	3.5 .14	6.03 kg 13.30 lb	97900	228.600 9.0000	38.100 1.5000	3.3 .13	3.38 kg 7.46 lb	53.975 2.1250	97501TD: TAPERED BORE 97901D : GROOVE IN OD CENTER HOLES IN OD CENTER	
97472X	120.000 4.7244	49.428 1.9460	3.5 .14	5.63 kg 12.41 lb	*97901D	228.600 9.0000	84.138 3.3125	2.3 .09	7.38 kg 16.27 lb	115.888 4.5625		

\*\*These Maximum Fillet Radii will be cleared by the Cone or Cup Radii.  
†Bore or O.D. shown are maximum dimensions. \*See Remarks Column.

97000 – 99000 SERIES

5

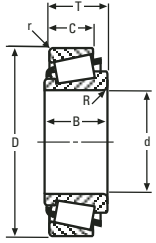

SINGLE ROW



SINGLE ROW WITH FLANGE

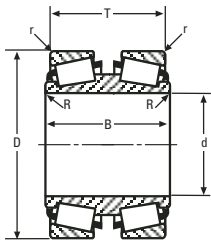

DOUBLE CONE

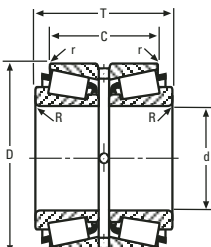

DOUBLE CUP

CONE			Max Shaft Fillet Radii R <sup>**</sup>	Weight	CUP			Max Hs'ng Fillet Radii r <sup>**</sup>	Weight	BEARING WIDTH T	Remarks
Number	BORE d	WIDTH B			Number	OUTSIDE DIA D	WIDTH C				
<b>97000 Series (cont)</b>											
97493	125.298 4.9330	49.428 1.9460	3.5 .14	5.23 kg 11.53 lb	97905X	230.000 9.0551	38.100 1.5000	3.3 .13	3.53 kg 7.78 lb	53.975 2.1250	
97500	127.000 5.0000	49.428 1.9460	3.5 .14	5.10 kg 11.24 lb							
97503	127.792 5.0312	49.428 1.9460	3.5 .14	5.04 kg 11.11 lb							
NA97450	114.300 4.5000	57.942 2.2812	3.5 .14	- -	*97901D	228.600 9.0000	84.138 3.3125	2.3 .09	7.38 kg 16.27 lb	115.885 4.5624	
97500D	127.000 5.0000	151.244 5.9545	1.5 .06	18.81 kg 41.49 lb	97900	228.600 9.0000	38.100 1.5000	3.3 .13	3.38 kg 7.46 lb	160.338 6.3125	
*97501TD	127.000 5.0000	151.244 5.9545	1.5 .06	20.28 kg 44.72 lb	97905X	230.000 9.0551	38.100 1.5000	3.3 .13	3.53 kg 7.78 lb	160.338 6.3125	
<b>98000 Series</b>											
98316	80.000 3.1496	49.212 1.9375	3.5 .14	5.73 kg 12.63 lb	*98788-B	200.000 7.8740	34.925 1.3750	3.3 .13	2.51 kg 5.54 lb	27.361 1.0772	98788-B : FLANGE ON OD FRONTFACE, BEARING WIDTH IS T1 DIMENSION
98335	85.000 3.3465	49.212 1.9375	3.5 .14	5.48 kg 12.08 lb	98788	200.000 7.8740	34.925 1.3750	3.3 .13	2.28 kg 5.03 lb	52.761 2.0772	98789D : GROOVE IN OD CENTER HOLES IN OD CENTER
98350	88.900 3.5000	49.212 1.9375	3.5 .14	5.27 kg 11.63 lb	*98789DC	200.025 7.8750	80.216 3.1581	2.3 .09	5.36 kg 11.83 lb	115.888 4.5625	98789DC : HOLES IN OD CENTER
98354	89.974 3.5423	49.212 1.9375	3.5 .14	5.21 kg 11.50 lb	*98789D	200.025 7.8750	80.216 3.1581	2.3 .09	5.36 kg 11.82 lb	115.888 4.5625	
98354X	90.000 3.5433	49.212 1.9375	3.5 .14	5.21 kg 11.49 lb							
98393	99.898 3.9330	49.212 1.9375	3.5 .14	4.64 kg 10.24 lb							
98394X	100.000 3.9370	49.212 1.9375	3.5 .14	4.64 kg 10.23 lb							
98400	101.600 4.0000	49.212 1.9375	3.5 .14	4.54 kg 10.01 lb							
NA98350	88.900 3.5000	57.942 2.2812	3.5 .14	- -	*98789DC	200.025 7.8750	80.216 3.1581	2.3 .09	5.36 kg 11.83 lb	115.885 4.5624	
					*98789D	200.025 7.8750	80.216 3.1581	2.3 .09	5.36 kg 11.82 lb	115.885 4.5624	
<b>99000 Series</b>											
99500	127.000 5.0000	66.675 2.6250	6.4 .25	11.19 kg 24.68 lb	99097	249.974 9.8415	53.400 2.1024	3.0 .12	3.81 kg 8.41 lb	66.675 2.6250	99600TD: ASYMMETRICAL BEARING TAPERED BORE
99537	136.525 5.3750	66.675 2.6250	7.0 .28	10.14 kg 22.37 lb	99098X	250.000 9.8425	47.625 1.8750	3.3 .13	3.62 kg 7.98 lb	66.675 2.6250	99601TD: TAPERED BORE
99540	137.318 5.4062	66.675 2.6250	13.5 .53	9.53 kg 21.01 lb	99100	254.000 10.0000	47.625 1.8750	3.3 .13	4.24 kg 9.35 lb	66.675 2.6250	99602TD: ASYMMETRICAL BEARING GROOVE IN OD LEFTFACE
99550	139.700 5.5000	66.675 2.6250	7.0 .28	9.76 kg 21.52 lb	*99100-B	254.000 10.0000	47.625 1.8750	3.3 .13	4.61 kg 10.16 lb	30.162 1.1875	SHOULDER ON OD LEFTFACE TAPERED BORE
99553	139.974 5.5108	71.438 2.8125	1.5 .06	10.08 kg 22.23 lb	99100-S	254.000 10.0000	47.625 1.8750	3.3 .13	4.24 kg 9.35 lb	66.675 2.6250	99100-B : FLANGE ON OD FRONTFACE, BEARING WIDTH IS T1 DIMENSION
99575	146.050 5.7500	66.675 2.6250	7.0 .28	9.01 kg 19.87 lb	*99100W	254.000 10.0000	47.625 1.8750	.8 .03	4.20 kg 9.25 lb	66.675 2.6250	99100W : KEYWAY IN OD BACKFACE
99575-SW	146.050 5.7500	66.675 2.6250	7.0 .28	9.04 kg 19.94 lb	*99100YD	254.000 10.0000	133.350 5.2500	1.5 .06	13.07 kg 28.83 lb	171.450 6.7500	99100YD : HOLES IN OD CENTER
99587	149.225 5.8750	66.675 2.6250	7.0 .28	8.62 kg 19.02 lb	*99101D	254.000 10.0000	114.300 4.5000	1.5 .06	10.92 kg 24.08 lb	152.400 6.0000	99101D : GROOVE IN OD CENTER HOLES IN OD CENTER
99590X	150.000 5.9055	66.675 2.6250	7.0 .28	8.53 kg 18.81 lb	*99101DC	254.000 10.0000	114.300 4.5000	1.5 .06	10.84 kg 23.91 lb	152.400 6.0000	
99591	149.974 5.9045	71.438 2.8125	3.3 .13	8.79 kg 19.39 lb	*99102CD	254.000 10.0000	111.125 4.3750	1.5 .06	9.81 kg 21.63 lb	149.225 5.8750	99101DC : HOLES IN OD CENTER
99600	152.400 6.0000	66.675 2.6250	7.0 .28	8.23 kg 18.15 lb	*99103D	254.975 10.0384	111.125 4.3750	1.5 .06	10.47 kg 23.08 lb	149.225 5.8750	99102CD : GROOVE IN OD CENTER HOLES IN OD CENTER
99603	152.400 6.0000	71.438 2.8125	1.5 .06	8.49 kg 18.72 lb							
99603AS	152.400 6.0000	71.438 2.8125	1.5 .06	8.53 kg 18.82 lb							99103D : GROOVE IN OD CENTER HOLES IN OD CENTER

99000 SERIES CONTINUED ON NEXT PAGE

\*\*These Maximum Fillet Radii will be cleared by the Cone or Cup Radii.  
†Bore or O.D. shown are maximum dimensions. \*See Remarks Column.

CONE			Max Shaft Fillet Radii R <sup>**</sup>	Weight	CUP			Max Hs'ng Fillet Radii r <sup>**</sup>	Weight	BEAR-ING	Remarks
Number	BORE d	WIDTH B			Number	OUTSIDE DIA D	WIDTH C			WIDTH T	
99000 Series (cont)											
*99601TD	152.400 6.0000	158.750 6.2500	3.2 .13	25.10 kg 55.35 lb	99097	249.974 9.8415	53.400 2.1024	3.0 .12	3.81 kg 8.41 lb	158.750 6.2500	
*99602TD	152.400 6.0000	182.562 7.1875	1.5 .06	27.20 kg 59.97 lb	99098X	250.000 9.8425	47.625 1.8750	3.3 .13	3.62 kg 7.98 lb	158.750 6.2500	
99603D	152.400 6.0000	158.750 6.2500	1.5 .06	23.41 kg 51.62 lb	99100	254.000 10.0000	47.625 1.8750	3.3 .13	4.24 kg 9.35 lb	158.750 6.2500	
					99100-S	254.000 10.0000	47.625 1.8750	3.3 .13	4.24 kg 9.35 lb	158.750 6.2500	
					*99100W	254.000 10.0000	47.625 1.8750	.8 .03	4.20 kg 9.25 lb	158.750 6.2500	
99587D	149.225 5.8750	120.650 4.7500	1.5 .06	20.08 kg 44.28 lb	99587D and grouped cones may be paired with all single cups corresponding to 99601TD and will require -38.100 mm (-1.5000 in) to be added to the T-width values.						
*99600TD	152.400 6.0000	120.650 4.7500	1.5 .06	20.53 kg 45.26 lb							
NA99600	152.400 6.0000	71.438 2.8125	3.5 .14	16.65 kg 36.71 lb	*99100YD	254.000 10.0000	133.350 5.2500	1.5 .06	13.07 kg 28.83 lb	142.875 5.6250	
					*99101D	254.000 10.0000	114.300 4.5000	1.5 .06	10.92 kg 24.08 lb	142.875 5.6250	
					*99101DC	254.000 10.0000	114.300 4.5000	1.5 .06	10.84 kg 23.91 lb	142.875 5.6250	
					*99102CD	254.000 10.0000	111.125 4.3750	1.5 .06	9.81 kg 21.63 lb	142.875 5.6250	
					*99103D	254.975 10.0384	111.125 4.3750	1.5 .06	10.47 kg 23.08 lb	142.875 5.6250	

5

\*\*These Maximum Fillet Radii will be cleared by the Cone or Cup Radii.  
†Bore or O.D. shown are maximum dimensions. \*See Remarks Column.

100000 – 107000 SERIES

CONE			Max Shaft Fillet Radii R <sup>**</sup>	Weight	CUP			Max Hs'ng Fillet Radii r <sup>**</sup>	Weight	BEARING	Remarks
Number	BORE d	WIDTH B			Number	OUTSIDE DIA D	WIDTH C			WIDTH T	
<b>100000 Series</b>											
EE101103	280.192 11.0312	50.211 1.9768	6.8 .27	13.16 kg 29.01 lb	101575	400.050 15.7500	34.925 1.3750	3.3 .13	5.58 kg 12.30 lb	52.387 2.0625	101601CD : GROOVE IN OD CENTER HOLES IN OD CENTER
					101600	406.400 16.0000	34.925 1.3750	3.3 .13	6.67 kg 14.71 lb	52.387 2.0625	
					*101601CD	406.400 16.0000	85.725 3.3750	1.5 .06	16.47 kg 36.31 lb	120.649 4.7500	
NA101103	280.192 11.0312	60.325 2.3750	6.4 .25	-	*101601CD	406.400 16.0000	85.725 3.3750	1.5 .06	16.47 kg 36.31 lb	120.650 4.7500	
<b>L102800 Series</b>											
L102849	44.450 1.7500	18.258 .7188	1.5 .06	20 kg .43 lb	L102810-B	73.025 2.8750	15.083 .5938	1.5 .06	.12 kg .26 lb	6.350 .2500	L102810-B : FLANGE ON OD FRONTFACE, BEARING WIDTH IS T1 DIMENSION
					L102810	73.025 2.8750	15.083 .5938	1.5 .06	.10 kg .22 lb	18.258 .7188	
<b>LM102900 Series</b>											
LM102949	45.242 1.7812	19.812 .7800	3.5 .14	.21 kg .47 lb	LM102910	73.431 2.8910	15.748 .6200	.8 .03	.10 kg .22 lb	19.558 .7700	
					LM102910P	73.431 2.8910	15.748 .6200	.8 .03	.10 kg .22 lb	19.558 .7700	
LM102949CP	45.242 1.7812	19.812 .7800	3.5 .14	.21 kg .47 lb	LM102911	73.431 2.8910	17.620 .6937	.8 .03	.12 kg .26 lb	21.430 .8437	
					LM102911P	73.431 2.8910	17.620 .6937	.8 .03	.12 kg .26 lb	21.430 .8437	
LM102949P	45.242 1.7812	19.812 .7800	3.5 .14	.21 kg .47 lb	LM102911	73.431 2.8910	17.620 .6937	.8 .03	.12 kg .26 lb	21.430 .8437	
					LM102911P	73.431 2.8910	17.620 .6937	.8 .03	.12 kg .26 lb	21.430 .8437	
<b>LL103000 Series</b>											
LL103049	44.450 1.7500	12.700 .5000	1.5 .06	.13 kg .28 lb	LL103010	71.438 2.8125	9.525 .3750	1.5 .06	.05 kg .12 lb	12.700 .5000	LL103049V : MADE FROM VACUUM MELT STEEL
					*LL103049V	44.450 1.7500	12.700 .5000	1.5 .06	.13 kg .28 lb	*LL103010-B	
					*LL103010V	71.438 2.8125	9.525 .3750	1.5 .06	.05 kg .12 lb	12.700 .5000	LL103010V : MADE FROM VACUUM MELT STEEL
<b>LM104900 Series</b>											
*†JLM104942A	48.600 1.9134	21.500 .8465	.4 .01	-	†JLM104910	82.000 3.2283	17.000 .6693	.5 .02	.13 kg .28 lb	21.500 .8465	JLM104942A : SPECIAL FRONTFACE RADIUS
					†JLM104910-Z	82.000 3.2283	17.000 .6693	.5 .02	.13 kg .28 lb	21.500 .8465	JLM104945 : EXTENDED SMALL RIB
*†JLM104945	50.000 1.9685	27.700 1.0906	3.0 .12	-	LM104911	82.550 3.2500	16.510 .6500	1.3 .05	.13 kg .29 lb	21.116 .8313	JLM104946 : EXTENDED SMALL RIB
*†JLM104946	50.000 1.9685	23.993 .9446	3.5 .14	-	LM104911A	82.550 3.2500	18.542 .7300	.8 .03	.16 kg .34 lb	23.148 .9113	LM104949E : EXTENDED SMALL RIB
†JLM104948	50.000 1.9685	21.500 .8465	3.0 .12	-	LM104911P	82.550 3.2500	16.510 .6500	1.3 .05	.13 kg .29 lb	21.116 .8313	
					LM104912	82.931 3.2650	16.510 .6500	1.3 .05	.14 kg .30 lb	21.116 .8313	
					†JLM104914	88.000 3.4646	17.000 .6693	.8 .03	.24 kg .52 lb	21.500 .8465	
LM104947A	49.987 1.9680	22.225 .8750	.5 .02	-	LM104947A and grouped cones may be paired with all single cups corresponding to JLM104942A and will require .475 mm (.0187 in) to be added to the T-width values.						
LM104949	50.800 2.0000	22.225 .8750	3.5 .14	-							
*LM104949E	50.800 2.0000	25.883 1.0190	3.5 .14	-							
LM104949P	50.800 2.0000	22.225 .8750	3.5 .14	-							
<b>107000 Series</b>											
EE107055	139.700 5.5000	74.612 2.9375	6.4 .25	12.55 kg 27.68 lb	107105	268.288 10.5625	57.150 2.2500	6.4 .25	5.83 kg 12.86 lb	74.613 2.9375	EE107057V : MADE FROM VACUUM MELT STEEL
					*107105-B	268.288 10.5625	57.150 2.2500	6.4 .25	6.91 kg 15.23 lb	28.575 1.1250	EE107060V : MADE FROM VACUUM MELT STEEL
EE107057	146.050 5.7500	74.612 2.9375	6.4 .25	11.72 kg 25.84 lb	*107105CD	268.288 10.5625	125.412 4.9375	1.5 .06	12.81 kg 28.24 lb	160.338 6.3125	107105-B : FLANGE ON OD FRONTFACE, BEARING WIDTH IS T1 DIMENSION
*EE107057V	146.050 5.7500	74.612 2.9375	6.4 .25	11.72 kg 25.85 lb	*107105V	268.288 10.5625	57.150 2.2500	6.4 .25	5.83 kg 12.86 lb	74.613 2.9375	107105CD : GROOVE IN OD CENTER HOLES IN OD CENTER
EE107060	152.400 6.0000	74.612 2.9375	6.4 .25	10.85 kg 23.92 lb							

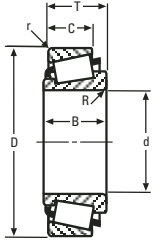

SINGLE ROW

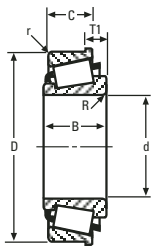

SINGLE ROW WITH FLANGE

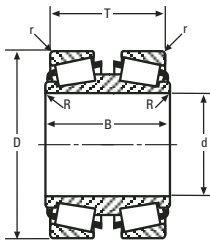

DOUBLE CONE

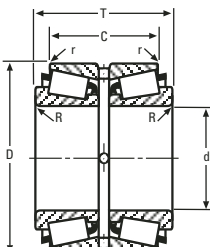

DOUBLE CUP

107000 SERIES CONTINUED ON NEXT PAGE

\*\*These Maximum Fillet Radii will be cleared by the Cone or Cup Radii.  
†Bore or O.D. shown are maximum dimensions. \*See Remarks Column.



CONE			Max Shaft Fillet Radii R''	Weight	CUP			Max Hs'ng Fillet Radii r''	Weight	BEARING WIDTH T	Remarks
Number	BORE d	WIDTH B			Number	OUTSIDE DIA D	WIDTH C				
<b>107000 Series (cont)</b>											
*EE107060V	152.400 6.0000	74.612 2.9375	6.4 .25	10.90 kg 24.03 lb	107107	269.800 10.6220	57.150 2.2500	6.4 .25	6.12 kg 13.48 lb	74.613 2.9375	107105V : MADE FROM VACUUM MELT STEEL
107960	152.400 6.0000	77.788 3.0625	6.4 .25	12.12 kg 26.73 lb							
<b>108000 Series</b>											
EE108065	165.100 6.5000	104.775 4.1250	13.5 .53	- -	108142	361.950 14.2500	76.200 3.0000	3.3 .13	15.77 kg 34.78 lb	106.362 4.1875	
<b>109000 Series</b>											
EE109120	304.800 12.0000	53.975 2.1250	6.4 .25	26.45 kg 58.31 lb	*109161D	412.750 16.2500	127.000 5.0000	1.5 .06	21.02 kg 46.35 lb	158.750 6.2500	109161D : GROOVE IN OD CENTER HOLES IN OD CENTER
					*109163D	412.750 16.2500	92.075 3.6250	1.5 .06	13.71 kg 30.22 lb	123.825 4.8750	109163D : GROOVE IN OD CENTER HOLES IN OD CENTER
<b>110000 Series</b>											
EE111175	298.450 11.7500	58.738 2.3125	6.4 .25	17.27 kg 30.08 lb	111700	431.800 17.0000	53.975 2.1250	3.3 .13	11.20 kg 24.70 lb	69.850 24.70	
<b>LM110800 Series</b>											
LM110848	63.500 2.5000	25.400 1.0000	1.5 .06	.49 kg 1.08 lb	LM110811	101.600 4.0000	22.225 .8750	1.5 .06	.27 kg .60 lb	25.400 1.0000	
<b>M111000 Series</b>											
M111048	63.500 2.5000	25.908 1.0200	.8 .03	.61 kg 1.35 lb	M111012	107.950 4.2500	20.320 .8000	.8 .03	.31 kg .69 lb	25.398 .9999	
<b>113000 Series</b>											
†J113086	220.000 8.6614	85.725 3.3750	6.4 .25	- -	113170	431.800 17.0000	49.212 1.9375	6.4 .25	15.12 kg 33.34 lb	92.075 3.6250	113171D : GROOVE IN OD CENTER HOLES IN OD CENTER
EE113089	228.397 8.9920	85.725 3.3750	6.4 .25	- -	*113171D	431.800 17.0000	111.125 4.3750	3.3 .13	35.41 kg 78.07 lb	196.850 7.7500	113171DV : GROOVE IN OD CENTER HOLES IN OD CENTER
EE113089V	228.397 8.9920	85.725 3.3750	6.4 .25	- -	*113171DV	431.800 17.0000	111.125 4.3750	3.3 .13	35.41 kg 78.07 lb	196.850 7.7500	
EE113091	228.460 8.9945	85.725 3.3750	6.4 .25	- -	*113181	459.892 18.1060	49.212 1.9375	spcl. spcl.	21.14 kg 46.62 lb	92.075 3.6250	113181 : SHOULDER ON OD BACKFACE SPECIAL RADIUS ON BACKFACE OD
EE113090D	228.600 9.0000	158.750 6.2500	6.4 .25	- -	113170	431.800 17.0000	49.212 1.9375	6.4 .25	15.12 kg 33.34 lb	158.750 6.2500	
					*113181	459.892 18.1060	49.212 1.9375	spcl. spcl.	21.14 kg 46.62 lb	158.750 6.2500	
<b>114000 Series</b>											
EE114080	203.200 8.0000	85.725 3.3750	6.4 .25	- -	114160	406.400 16.0000	57.150 2.2500	6.4 .25	16.29 kg 35.91 lb	92.075 3.6250	114161D : GROOVE IN OD CENTER HOLES IN OD CENTER
EE114081	203.238 8.0015	85.725 3.3750	6.4 .25	- -	*114161D	406.400 16.0000	127.000 5.0000	3.3 .13	38.52 kg 84.93 lb	196.850 7.7500	114161DC : HOLES IN OD CENTER
					*114161DC	406.400 16.0000	127.000 5.0000	3.3 .13	38.52 kg 84.93 lb	196.850 7.7500	
<b>LM114800 Series</b>											
LM114848	76.200 3.0000	26.988 1.0625	1.5 .06	.64 kg 1.41 lb	LM114811	115.888 4.5625	23.812 .9375	1.5 .06	.35 kg .77 lb	26.987 1.0625	LM114811D : GROOVE IN OD CENTER HOLES IN OD CENTER
					*LM114811D	115.888 4.5625	52.388 2.0625	.8 .03	.86 kg 1.89 lb	61.913 2.4375	
LM114848D	76.200 3.0000	53.975 2.1250	.8 .03	1.63 kg 3.59 lb	LM114811	115.888 4.5625	23.812 .9375	1.5 .06	.35 kg .77 lb	53.975 2.1250	
<b>116000 Series</b>											
EE116050	127.000 5.0000	63.500 2.5000	3.3 .13	8.39 kg 18.51 lb	116097	247.650 9.7500	47.625 1.8750	4.8 .19	4.68 kg 10.31 lb	63.500 2.5000	
					116098	250.825 9.8750	47.625 1.8750	4.8 .19	5.21 kg 11.49 lb	63.500 2.5000	
<b>L116100 Series</b>											
L116149	82.550 3.2500	21.433 .8438	1.5 .06	.46 kg 1.01 lb	L116110	115.888 4.5625	16.670 .6563	1.5 .06	.21 kg .46 lb	20.637 .8125	L116149DA: ASYMMETRICAL BEARING L116110-B : FLANGE ON OD FRONTFACE, BEARING WIDTH IS T1 DIMENSION
					*L116110-B	115.888 4.5625	16.670 .6563	1.5 .06	.23 kg .52 lb	7.938 .3125	
					*L116110D	115.888 4.5625	39.690 1.5626	.8 .03	.49 kg 1.09 lb	47.624 1.8750	L116110D : GROOVE IN OD CENTER HOLES IN OD CENTER

\*\*These Maximum Fillet Radii will be cleared by the Cone or Cup Radii.  
†Bore or O.D. shown are maximum dimensions. \*See Remarks Column.

**L116100 – 122000 SERIES**

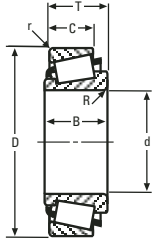

**SINGLE ROW**

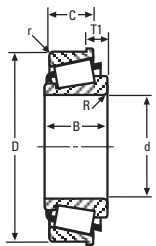

**SINGLE ROW WITH FLANGE**

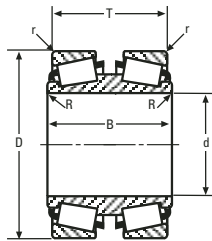

**DOUBLE CONE**

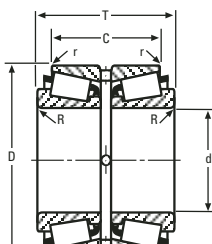

**DOUBLE CUP**

CONE			Max Shaft Fillet Radii R <sup>**</sup>	Weight	CUP			Max H's'ng Fillet Radii r <sup>**</sup>	Weight	BEARING WIDTH T	Remarks
Number	BORE d	WIDTH B			Number	OUTSIDE DIA D	WIDTH C				
<b>L116100 Series (cont)</b>											
*L116149DA	82.550 3.2500	49.212 1.9375	1.5 .06	1.20 kg 2.64 lb	*L116110DC	115.888 4.5625	39.690 1.5626	.8 .03	.49 kg 1.09 lb	47.624 1.8750	L116110DC: HOLES IN OD CENTER
					L116112	117.475 4.6250	16.670 .6563	1.5 .06	.24 kg .54 lb	20.637 .8125	
					*L116112DE	117.475 4.6250	53.975 2.1250	.8 .03	.83 kg 1.84 lb	61.909 2.4374	
					L116110	115.888 4.5625	16.670 .6563	1.5 .06	.21 kg .46 lb	41.275 1.6250	
L116112	117.475 4.6250	16.670 .6563	1.5 .06	.24 kg .54 lb	41.275 1.6250						
<b>LL116200 Series</b>											
LL116249	82.550 3.2500	15.083 .5938	1.5 .06	.32 kg .71 lb	LL116210	114.300 4.5000	11.112 .4375	1.5 .06	.12 kg .26 lb	15.083 .5938	
<b>LM116500 Series</b>											
LM116548	82.550 3.2500	28.575 1.1250	2.3 .09	.78 kg 1.73 lb	LM116511	123.825 4.8750	25.400 1.0000	2.3 .09	.42 kg .93 lb	28.575 1.1250	
<b>117000 Series</b>											
*EE117063	161.925 6.3750	79.375 3.1250	6.4 .25	- -	*117148	374.650 14.7500	60.325 2.3750	1.5 .06	15.06 kg 33.20 lb	87.312 3.4375	EE117063: EXTENDED LARGE RIB SHOULDER ON OD BACKFACE
EE117063X	161.925 6.3750	79.375 3.1250	6.4 .25	- -							EE117067: EXTENDED LARGE RIB SHOULDER ON OD BACKFACE
*EE117067	171.450 6.7500	79.375 3.1250	6.4 .25	- -							117148: SHOULDER ON OD BACKFACE SPECIAL RADIUS ON BACKFACE OD
<b>L117500 Series</b>											
L117549	88.900 3.5000	19.050 .7500	2.3 .09	.53 kg 1.17 lb	L117510	125.412 4.9375	15.083 .5938	2.3 .09	.18 kg .41 lb	19.050 .7500	
<b>LM117900 Series</b>											
*LM117949	88.900 3.5000	28.575 1.1250	2.3 .09	.88 kg 1.94 lb	LM117910	130.175 5.1250	25.400 1.0000	2.3 .09	.44 kg .96 lb	28.574 1.1250	LM117949: SPECIAL BACKFACE RADIUS SPECIAL FRONTFACE RADIUS
<b>LM119300 Series</b>											
LM119348	95.250 3.7500	30.162 1.1875	2.4 .09	.87 kg 1.93 lb	LM119311	136.525 5.3750	24.608 .9688	2.3 .09	.47 kg 1.04 lb	30.162 1.1875	LM119311D: GROOVE IN OD CENTER HOLES IN OD CENTER
					*LM119311D	136.525 5.3750	57.150 2.2500	.8 .03	1.12 kg 2.48 lb	68.259 2.6874	
LM119348D	95.250 3.7500	57.150 2.2500	.8 .03	2.15 kg 4.74 lb	LM119311	136.525 5.3750	24.608 .9688	2.3 .09	.47 kg 1.04 lb	57.149 2.2500	
<b>LM120700 Series</b>											
LM120749	101.600 4.0000	31.750 1.2500	2.3 .09	1.13 kg 2.49 lb	LM120710	146.050 5.7500	28.575 1.1250	2.3 .09	.62 kg 1.36 lb	31.750 1.2500	
<b>HM120800 Series</b>											
HM120835	85.725 3.3750	49.212 1.9375	1.5 .06	6.16 kg 13.58 lb	*HM120817XD	165.100 6.5000	114.300 4.5000	- -	4.36 kg 9.62 lb	106.581 4.1961	HM120817D: GROOVE IN OD CENTER HOLES IN OD CENTER
HM120846	99.957 3.9353	49.212 1.9375	1.5 .06	4.56 kg 10.05 lb	HM120817YD	165.100 6.5000	114.300 4.5000	.8 .03	4.36 kg 9.62 lb	106.581 4.1961	HM120817XD: GROOVE IN OD CENTER
HM120848	101.600 4.0000	49.212 1.9375	1.5 .06	4.36 kg 9.61 lb	*HM120817D	165.100 6.5000	114.300 4.5000	.8 .03	4.36 kg 9.62 lb	106.581 4.1961	
<b>121000 Series</b>											
EE121140	355.600 14.0000	152.400 6.0000	16.0 .63	- -	121265	673.100 26.5000	114.300 4.5000	6.4 .25	79.01 kg 174.22 lb	152.400 6.0000	EE121140X: HOLES IN BACKFACE
*EE121140X	355.600 14.0000	152.400 6.0000	16.0 .63	- -	*121265X	673.100 26.5000	114.300 4.5000	6.4 .25	79.21 kg 174.67 lb	152.400 6.0000	121265X: HOLES IN BACKFACE
<b>LM121300 Series</b>											
LM121349	106.975 4.2116	28.000 1.1024	2.3 .09	.91 kg 2.00 lb	LM121310	146.975 5.7864	24.000 .9449	2.3 .09	.41 kg .90 lb	28.500 1.1220	
<b>LM121900 Series</b>											
LM121948D	107.950 4.2500	65.088 2.5625	.8 .03	2.97 kg 6.54 lb	LM121911	152.400 6.0000	28.575 1.1250	3.3 .13	.66 kg 1.45 lb	65.087 2.5625	
<b>122000 Series</b>											
EE122080	203.200 8.0000	66.675 2.6250	4.3 .17	12.45 kg 27.45 lb	122125	317.500 12.5000	50.800 2.0000	3.3 .13	5.69 kg 12.54 lb	66.675 2.6250	
122978	199.974 7.8730	70.000 2.7559	4.3 .17	12.78 kg 28.17 lb							

LM122900 SERIES CONTINUED ON NEXT PAGE

\*\*These Maximum Fillet Radii will be cleared by the Cone or Cup Radii.  
†Bore or O.D. shown are maximum dimensions. \*See Remarks Column.

LM122900 – 126000 SERIES

6

CONE			Max Shaft Fillet Radii R''	Weight	CUP			Max Hs'ng Fillet Radii r''	Weight	BEAR-ING	Remarks
Number	BORE d	WIDTH B			Number	OUTSIDE DIA D	WIDTH C			WIDTH T	
<b>LM122900 Series</b>											
LM122948	114.300 4.5000	34.925 1.3750	3.3 .13	1.31 kg 2.89 lb	LM122911	158.750 6.2500	30.162 1.1875	3.3 .13	.68 kg 1.49 lb	34.925 1.3750	LM122948XX: MADE FROM VACUUM MELT STEEL
*LM122948XX	114.300 4.5000	34.925 1.3750	3.3 .13	1.31 kg 2.89 lb	*LM122911D	158.750 6.2500	68.262 2.6875	.8 .03	1.51 kg 3.32 lb	77.787 3.0625	LM122911D : GROOVE IN OD CENTER HOLES IN OD CENTER
<b>LM124400 Series</b>											
*LM124448	120.650 4.7500	52.388 2.0625	.5 .02	1.82 kg 4.02 lb	*LM124410-B	166.688 6.5625	31.750 1.2500	3.3 .13	.72 kg 1.58 lb	25.400 1.0000	LM124448: EXTENDED LARGE RIB GROOVE IN OD BACKFACE SHOULDER ON OD BACKFACE
*LM124448EXX	120.650 4.7500	52.388 2.0625	.5 .02	2.28 kg 5.02 lb	LM124410	166.688 6.5625	31.750 1.2500	3.3 .13	.76 kg 1.68 lb	52.387 2.0625	LM124448EXX: MADE FROM VACUUM MELT STEEL
*LM124448V	120.650 4.7500	52.388 2.0625	.5 .02	1.89 kg 4.18 lb	*LM124410D	166.688 6.5625	71.438 2.8125	.8 .03	1.77 kg 3.89 lb	112.712 4.4375	LM124448V: GROOVE IN OD BACKFACE MADE FROM VACUUM MELT STEEL
					*LM124411V	167.323 6.5875	41.275 1.6250	3.3 .13	1.17 kg 2.57 lb	61.912 2.4375	SHOULDER ON OD BACKFACE
LM124449D	120.650 4.7500	72.238 2.8440	.8 .03	3.77 kg 8.31 lb	LM124410	166.688 6.5625	31.750 1.2500	3.3 .13	.76 kg 1.68 lb	72.237 2.8440	LM124410-B : FLANGE ON OD FRONTFACE, BEARING WIDTH IS T1 DIMENSION SPECIAL RADIUS ON BACKFACE OD
LM124449DW	120.650 4.7500	72.238 2.8440	.8 .03	3.77 kg 8.31 lb	*LM124411V	167.323 6.5875	41.275 1.6250	3.3 .13	1.17 kg 2.57 lb	91.287 3.5940	LM124410D : GROOVE IN OD CENTER HOLES IN OD CENTER
											LM124411V : MADE FROM VACUUM MELT STEEL
LM124449	120.650 4.7500	36.512 1.4375	3.3 .13	1.50 kg 3.32 lb	LM124449 may be paired with all single cups corresponding to LM124448 and will require -.15875 mm (-.6250 in) to be added to the T-width values. LM124449 may be paired with all double cups corresponding to LM124448 and will require -.31750 mm (-1.2500 in) to be added to the T-width values.						
<b>HM124600 Series</b>											
HM124640	109.941 4.3284	57.150 2.2500	1.5 .06	4.41 kg 9.73 lb	*HM124616XD	194.874 7.6722	131.351 5.1713	1.6 .06	6.96 kg 15.35 lb	125.254 4.9313	HM124616AD : GROOVE IN OD CENTER HOLES IN OD CENTER SPECIAL RADIUS ON LEFTFACE OD
HM124644	117.373 4.6210	57.150 2.2500	1.5 .06	3.81 kg 8.40 lb	*HM124616AD	194.874 7.6722	131.351 5.1713	spcl. spcl.	6.63 kg 14.62 lb	125.254 4.9313	SPECIAL RADIUS ON RIGHTFACE OD
HM124646	119.062 4.6875	57.150 2.2500	1.5 .06	3.67 kg 8.09 lb	*HM124618YD	195.262 7.6875	142.875 5.6250	- -	7.82 kg 17.25 lb	136.778 5.3850	HM124616XD : GROOVE IN OD CENTER
HM124649	119.957 4.7227	57.150 2.2500	3.0 .12	3.58 kg 7.90 lb	*HM124618XD	195.262 7.6875	142.875 5.6250	1.0 .04	7.82 kg 17.25 lb	136.778 5.3850	HM124618XD : GROOVE IN OD CENTER
					HM124618	195.262 7.6875	44.450 1.7500	3.3 .13	2.45 kg 5.41 lb	53.975 2.1250	HM124618YD : GROOVE IN OD CENTER HOLES IN OD CENTER
<b>125000 Series</b>											
EE125094	241.122 9.4930	68.262 2.6875	6.4 .25	16.05 kg 35.38 lb	*125145-B	368.300 14.5000	53.975 2.1250	3.3 .13	9.19 kg 20.26 lb	26.987 1.0625	125145-B : FLANGE ON OD FRONTFACE, BEARING WIDTH IS T1 DIMENSION
EE125095	241.300 9.5000	68.262 2.6875	6.4 .25	15.72 kg 34.66 lb	125145	368.300 14.5000	53.975 2.1250	3.3 .13	8.47 kg 18.69 lb	68.262 2.6875	
<b>HM125600 Series</b>											
HM125649	123.825 4.8750	57.150 2.2500	1.5 .06	7.75 kg 17.08 lb	HM125610XD	198.438 7.8125	133.350 5.2500	- -	6.59 kg 14.52 lb	127.255 5.0100	
<b>LM125700 Series</b>											
LM125748	127.000 5.0000	36.512 1.4375	3.3 .13	1.67 kg 3.69 lb	LM125711	174.625 6.8750	31.750 1.2500	3.3 .13	.88 kg 1.94 lb	36.512 1.4375	LM125748AV: MADE FROM VACUUM MELT STEEL
*LM125748AV	127.000 5.0000	36.512 1.4375	1.0 .04	1.68 kg 3.70 lb	*LM125711V	174.625 6.8750	31.750 1.2500	3.3 .13	.88 kg 1.94 lb	36.512 1.4375	LM125711V : MADE FROM VACUUM MELT STEEL
<b>HM125900 Series</b>											
HM125943	119.949 4.7224	60.325 2.3750	3.3 .13	5.23 kg 11.54 lb	HM125910	204.775 8.0620	45.237 1.7810	3.3 .13	2.30 kg 5.08 lb	55.563 2.1875	
HM125948	123.825 4.8750	60.325 2.3750	3.3 .13	4.86 kg 10.71 lb							
<b>126000 Series</b>											
EE126096D	244.475 9.6250	146.050 5.7500	3.3 .13	47.28 kg 104.26 lb	126150	381.000 15.0000	57.150 2.2500	4.8 .19	10.77 kg 23.75 lb	146.050 5.7500	EE126096DGW: GROOVE IN ID
*EE126096DGW	244.475 9.6250	146.050 5.7500	3.3 .13	47.20 kg 104.07 lb							126149D : GROOVE IN OD CENTER HOLES IN OD CENTER
EE126097	244.475 9.6250	76.200 3.0000	6.4 .25	19.46 kg 42.91 lb	*126149DC	380.898 14.9960	127.000 5.0000	1.5 .06	24.71 kg 54.48 lb	171.450 6.7500	126149DC : HOLES IN OD CENTER

\*\*These Maximum Fillet Radii will be cleared by the Cone or Cup Radii.  
†Bore or O.D. shown are maximum dimensions. \*See Remarks Column.

126000 – HM127400 SERIES

CONE			Max Shaft Fillet Radii R <sup>**</sup>	Weight	CUP			Max Hs'ng Fillet Radii r <sup>**</sup>	Weight	BEARING WIDTH T	Remarks
Number	BORE d	WIDTH B			Number	OUTSIDE DIA D	WIDTH C				
<b>126000 Series (cont)</b>											
EE126098	249.250 9.8130	76.200 3.0000	6.4 .25	18.36 kg 40.47 lb	*126149D 380.898 14.9960	127.000 5.0000	1.5 .06	24.71 kg 54.48 lb	171.450 6.7500	126150-B : FLANGE ON OD FRONTFACE, BEARING WIDTH IS T1 DIMENSION	
					*126150-B 381.000 15.0000	57.150 2.2500	4.8 .19	12.33 kg 27.19 lb	34.925 1.3750		
					126150 381.000 15.0000	57.150 2.2500	4.8 .19	10.77 kg 23.75 lb	79.375 3.1250	126151CD : GROOVE IN OD CENTER HOLES IN OD CENTER	
					*126151CD 381.000 15.0000	127.000 5.0000	1.5 .06	24.59 kg 54.23 lb	171.450 6.7500		
<b>127000 Series</b>											
EE127094D	241.224 9.4970	107.950 4.2500	1.5 .06	27.30 kg 60.20 lb	127135 349.148 13.7460	44.450 1.7500	3.3 .13	5.55 kg 12.23 lb	107.950 4.2500	NA127096-SW: EXTENDED LARGE RIB SLOTS IN FRONTFACE	
EE127097D	241.478 9.5070	107.950 4.2500	1.5 .06	27.22 kg 60.02 lb	127137 350.838 13.8125	44.450 1.7500	3.3 .13	5.87 kg 12.94 lb	107.950 4.2500	127136CD : GROOVE IN OD CENTER HOLES IN OD CENTER	
EE127097DW	241.478 9.5070	107.950 4.2500	1.5 .06	27.22 kg 60.02 lb	127138 355.498 13.9960	44.450 1.7500	3.3 .13	6.77 kg 14.92 lb	107.950 4.2500	127137D : GROOVE IN OD CENTER HOLES IN OD CENTER	
					127140 355.600 14.0000	44.450 1.7500	3.3 .13	6.79 kg 14.96 lb	107.950 4.2500	127139D : GROOVE IN OD CENTER HOLES IN OD CENTER	
EE127095	241.300 9.5000	57.150 2.2500	6.4 .25	11.05 kg 24.37 lb	127135 349.148 13.7460	44.450 1.7500	3.3 .13	5.55 kg 12.23 lb	57.150 2.2500		
					*127136CD 349.148 13.7460	101.600 4.0000	1.5 .06	12.63 kg 27.86 lb	127.000 5.0000		
					127137 350.838 13.8125	44.450 1.7500	3.3 .13	5.87 kg 12.94 lb	57.150 2.2500		
					*127137D 350.838 13.8125	101.600 4.0000	1.5 .06	14.16 kg 31.22 lb	127.000 5.0000		
					127138 355.498 13.9960	44.450 1.7500	3.3 .13	6.77 kg 14.92 lb	57.150 2.2500		
					*127139D 355.498 13.9960	101.600 4.0000	1.5 .06	16.22 kg 35.76 lb	127.000 5.0000		
					127140 355.600 14.0000	44.450 1.7500	3.3 .13	6.79 kg 14.96 lb	57.150 2.2500		
NA127096	244.475 9.6250	66.675 2.6250	6.4 .25	-	*127136CD 349.148 13.7460	101.600 4.0000	1.5 .06	12.63 kg 27.86 lb	133.350 5.2500		
*NA127096-SW	244.475 9.6250	66.675 2.6250	6.4 .25	-	*127137D 350.838 13.8125	101.600 4.0000	1.5 .06	14.16 kg 31.22 lb	133.350 5.2500		
					*127139D 355.498 13.9960	101.600 4.0000	1.5 .06	16.22 kg 35.76 lb	133.350 5.2500		
<b>HM127400 Series</b>											
HM127436	119.957 4.7227	57.150 2.2500	1.5 .06	5.35 kg 11.79 lb	*HM127415XD 207.962 8.1875	152.400 6.0000	1.0 .04	8.21 kg 18.11 lb	146.305 5.7600	HM127415D : GROOVE IN OD CENTER HOLES IN OD CENTER SPECIAL RADIUS ON LEFTFACE OD	
HM127440	126.987 4.9995	57.150 2.2500	1.5 .06	4.73 kg 10.42 lb	*HM127415D 207.962 8.1875	152.400 6.0000	1.0 .04	7.73 kg 17.04 lb	146.305 5.7600	SPECIAL RADIUS ON RIGHTFACE OD	
HM127442	129.967 5.1168	57.150 2.2500	1.5 .06	4.46 kg 9.83 lb	HM127415 207.962 8.1875	44.450 1.7500	3.3 .13	2.53 kg 5.58 lb	53.975 2.1250	HM127415XD : GROOVE IN OD CENTER SPECIAL RADIUS ON LEFTFACE OD	
HM127446	131.750 5.1870	57.150 2.2500	1.5 .06	4.29 kg 9.47 lb	*HM127415YD 207.950 8.1870	127.000 5.0000	.8 .03	7.46 kg 16.45 lb	146.050 5.7500	SPECIAL RADIUS ON RIGHTFACE OD	
					*HM127417YD 209.873 8.2627	132.000 5.1969	.8 .03	7.51 kg 16.56 lb	125.906 4.9569	HM127415XD : GROOVE IN OD CENTER SPECIAL RADIUS ON LEFTFACE OD	
					*HM127417XD 209.873 8.2627	132.000 5.1969	1.0 .04	7.53 kg 16.60 lb	125.906 4.9569	HM127415YD : HOLES IN OD CENTER	
					*HM127419XD 219.873 8.6564	135.000 5.3150	-	11.35 kg 25.03 lb	128.906 5.0750	HM127417XD : GROOVE IN OD CENTER SPECIAL RADIUS ON LEFTFACE OD	
										HM127417YD : GROOVE IN OD CENTER HOLES IN OD CENTER SPECIAL RADIUS ON LEFTFACE OD	
										SPECIAL RADIUS ON RIGHTFACE OD	
										HM127419XD : GROOVE IN OD CENTER	

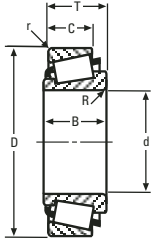

SINGLE ROW

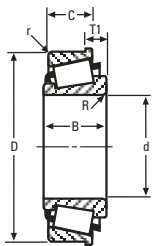

SINGLE ROW WITH FLANGE

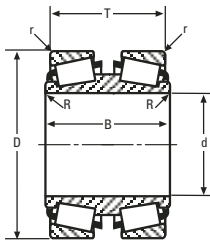

DOUBLE CONE

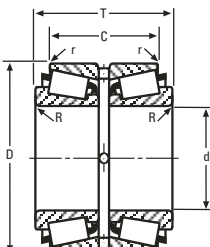

DOUBLE CUP

H127700 SERIES CONTINUED ON NEXT PAGE

\*\*These Maximum Fillet Radii will be cleared by the Cone or Cup Radii.  
†Bore or O.D. shown are maximum dimensions. \*See Remarks Column.

H127700 – HM129800 SERIES

6

CONE			Max Shaft Fillet Radii R <sup>**</sup>	Weight	CUP			Max Hs'ng Fillet Radii r <sup>**</sup>	Weight	BEARING WIDTH T	Remarks
Number	BORE d	WIDTH B			Number	OUTSIDE DIA D	WIDTH C				
<b>H127700 Series</b>											
H127746	129.967 5.1168	69.500 2.7362	1.5 .06	13.09 kg 28.86 lb	*H127710AD 219.873 8.6564	160.000 6.2992	spcl. spcl.	9.36 kg 20.64 lb	150.043 5.9072	H127710AD : GROOVE IN OD CENTER HOLES IN OD CENTER SPECIAL RADIUS ON LEFTFACE OD SPECIAL RADIUS ON RIGHTFACE OD  H127715AD : GROOVE IN OD CENTER HOLES IN OD CENTER SPECIAL RADIUS ON LEFTFACE OD SPECIAL RADIUS ON RIGHTFACE OD  H127715D : GROOVE IN OD CENTER HOLES IN OD CENTER  H127715YDC : HOLES IN OD CENTER SPECIAL RADIUS ON LEFTFACE OD SPECIAL RADIUS ON RIGHTFACE OD	
H127747	129.967 5.1168	69.500 2.7362	1.5 .06	12.22 kg 26.95 lb	*H127715AD 229.873 9.0501	160.000 6.2992	spcl. spcl.	13.76 kg 30.35 lb	150.043 5.9072		
H127747F	129.967 5.1168	69.500 2.7362	1.5 .06	10.97 kg 24.20 lb	*H127715D 229.873 9.0501	160.000 6.2992	1.0 .04	14.36 kg 31.67 lb	150.002 5.9056		
					*H127715YDC 229.873 9.0501	160.000 6.2992	spcl. spcl.	14.30 kg 31.54 lb	150.043 5.9072		
<b>128000 Series</b>											
EE128102	260.350 10.2500	67.673 2.6643	3.3 .13	- -	*128160-B 406.400 16.0000	53.975 2.1250	3.3 .13	10.41 kg 22.96 lb	28.575 1.1250	EE128113TD : REVERSE TAPERED BORE  128160-B : FLANGE ON OD FRONTFACE, BEARING WIDTH IS T1 DIMENSION	
EE128110	280.192 11.0312	67.673 2.6643	6.8 .27	- -	128160 406.400 16.0000	53.975 2.1250	3.3 .13	9.43 kg 20.79 lb	69.850 2.7500	128160CD : GROOVE IN OD CENTER HOLES IN OD CENTER	
EE128111	280.192 11.0312	67.673 2.6643	6.8 .27	17.45 kg 38.49 lb	*128160CD 406.400 16.0000	117.475 4.6250	1.5 .06	20.03 kg 44.16 lb	149.226 5.8750	128170DA : HOLES IN OD CENTER SPECIAL RADIUS ON LEFTFACE OD SPECIAL RADIUS ON RIGHTFACE OD SPHERICAL OD	
EE128112	280.000 11.0236	67.673 2.6643	6.4 .25	17.52 kg 38.64 lb	128161 409.981 16.1410	53.975 2.1250	3.3 .13	10.40 kg 22.92 lb	69.850 2.7500		
EE128114	280.000 11.0236	67.673 2.6643	6.4 .25	- -	*128170DA 431.800 17.0000	117.475 4.6250	1.5 .06	33.09 kg 72.96 lb	149.226 5.8750		
*EE128113TD	280.000 11.0236	206.375 8.1250	3.3 .13	66.50 kg 146.64 lb	128160 406.400 16.0000	53.975 2.1250	3.3 .13	9.43 kg 20.79 lb	206.376 8.1250		
EE128114D	280.000 11.0236	206.375 8.1250	3.3 .13	- -	128161 409.981 16.1410	53.975 2.1250	3.3 .13	10.40 kg 22.92 lb	206.376 8.1250		
<b>129000 Series</b>											
EE129119D	299.974 11.8100	134.938 5.3125	3.3 .13	53.16 kg 117.21 lb	129172 438.048 17.2460	53.975 2.1250	4.8 .19	11.37 kg 25.06 lb	133.350 5.2500	EE129119DG : GROOVE IN ID  129173CD : GROOVE IN OD CENTER HOLES IN OD CENTER	
*EE129119DG	299.974 11.8100	134.938 5.3125	3.3 .13	53.11 kg 117.11 lb	129174 439.948 17.3208	53.975 2.1250	4.8 .19	11.92 kg 26.28 lb	133.350 5.2500	129173D : GROOVE IN OD CENTER HOLES IN OD CENTER	
EE129121D	304.648 11.9940	134.938 5.3125	3.3 .13	50.86 kg 112.14 lb							
EE129123D	305.000 12.0079	134.938 5.3125	3.3 .13	50.68 kg 111.75 lb							
EE129120X	304.800 12.0000	76.992 3.0312	6.4 .25	22.37 kg 49.32 lb	129172 438.048 17.2460	53.975 2.1250	4.8 .19	11.37 kg 25.06 lb	76.200 3.0000		
					*129173D 438.048 17.2460	120.650 4.7500	1.5 .06	25.56 kg 56.35 lb	165.100 6.5000		
					*129173CD 438.048 17.2460	120.650 4.7500	1.5 .06	25.49 kg 56.21 lb	165.100 6.5000		
					129174 439.948 17.3208	53.975 2.1250	4.8 .19	11.92 kg 26.28 lb	76.200 3.0000		
					129175XD 439.948 17.3208	120.650 4.7500	1.5 .06	28.21 kg 62.21 lb	165.100 6.5000		
EE129124D	304.902 12.0040	212.725 8.3750	3.3 .13	68.29 kg 150.57 lb	EE129124D may be paired with all single cups corresponding to EE129119D and will require 63.500 mm (2.5000 in) to be added to the T-width values.						
<b>HM129800 Series</b>											
HM129842	139.687 5.4995	58.738 2.3125	1.5 .06	10.33 kg 22.77 lb	*HM129813YD 219.873 8.6564	140.000 5.5118	spcl. spcl.	7.04 kg 15.52 lb	132.329 5.2098	HM129848XX: MADE FROM VACUUM MELT STEEL HM129813XD : GROOVE IN OD CENTER	
HM129843	139.967 5.5105	58.738 2.3125	3.0 .12	10.25 kg 22.60 lb	*HM129813XD 219.873 8.6564	140.000 5.5118	- -	7.53 kg 16.60 lb	132.329 5.2098	HM129813YD : GROOVE IN OD CENTER HOLES IN OD CENTER	
HM129848	144.450 5.6870	58.738 2.3125	1.5 .06	9.35 kg 20.62 lb	*HM129814XDXX 220.662 8.6875	163.510 6.4374	- -	9.94 kg 21.91 lb	155.840 6.1354	SPECIAL CHAMFER ON LEFTFACE OD SPECIAL CHAMFER ON RIGHTFACE OD	

\*\*These Maximum Fillet Radii will be cleared by the Cone or Cup Radii.  
†Bore or O.D. shown are maximum dimensions. \*See Remarks Column.

HM129800 SERIES CONTINUED ON NEXT PAGE

HM129800 – 130000 SERIES

CONE			Max Shaft Fillet Radii R <sup>**</sup>	Weight	CUP			Max Hs'ng Fillet Radii r <sup>**</sup>	Weight	BEARING	Remarks
Number	BORE d	WIDTH B			Number	OUTSIDE DIA D	WIDTH C			WIDTH T	
<b>HM129800 Series (cont)</b>											
*HM129848XX	144.450 5.6870	58.738 2.3125	1.5 .06	9.35 kg 20.62 lb	*HM129814D	220.662 8.6875	163.510 6.4374	- -	9.85 kg 21.71 lb	155.840 6.1354	HM129814D : GROOVE IN OD CENTER HOLES IN OD CENTER
					*HM129814YD	220.650 8.6870	136.525 5.3750	.8 .03	9.22 kg 20.34 lb	155.576 6.1250	HM129814XD : GROOVE IN OD CENTER
					*HM129814XD	220.662 8.6875	163.510 6.4374	1.0 .04	9.71 kg 21.41 lb	155.840 6.1354	HM129814DXX : MADE FROM VACUUM MELT STEEL
					*HM129815YD	220.662 8.6875	163.510 6.4374	- -	9.22 kg 20.34 lb	155.840 6.1354	HM129814YD : HOLES IN OD CENTER HM129815YD : HOLES IN OD CENTER
<b>130000 Series</b>											
EE130787	200.025 7.8750	69.850 2.7500	6.8 .27	20.83 kg 45.93 lb	*131398D	354.950 13.9744	109.952 4.3288	1.5 .06	6.87 kg 15.14 lb	152.270 5.9949	EE130850DW: KEYWAY IN ID NA130858T: REVERSE TAPERED BORE
EE130851	215.900 8.5000	69.850 2.7500	6.8 .27	17.99 kg 39.66 lb	131400	355.600 14.0000	49.212 1.9375	1.5 .06	7.38 kg 16.28 lb	69.850 2.7500	NA130906T: TAPERED BORE
EE130889	225.425 8.8750	69.850 2.7500	6.8 .27	16.18 kg 35.67 lb	*131400DA	355.600 14.0000	111.125 4.3750	.8 .03	17.07 kg 37.64 lb	152.400 6.0000	EE130926TD: ASYMMETRICAL BEARING TAPERED BORE
EE130902	228.600 9.0000	69.850 2.7500	6.8 .27	15.56 kg 34.30 lb	*131401CD	355.600 14.0000	111.125 4.3750	1.5 .06	16.36 kg 36.07 lb	152.400 6.0000	EE130927TD: ASYMMETRICAL BEARING TAPERED BORE
					*131402D	355.600 14.0000	117.475 4.6250	.8 .03	17.78 kg 39.20 lb	158.751 6.2500	131398D : GROOVE IN OD CENTER HOLES IN OD CENTER
					*131500DA	381.000 15.0000	111.125 4.3750	1.5 .06	28.24 kg 62.26 lb	152.400 6.0000	131400DA : HOLES IN OD CENTER
EE130850D	215.900 8.5000	120.650 4.7500	1.5 .06	39.45 kg 86.98 lb	131400	355.600 14.0000	49.212 1.9375	1.5 .06	7.38 kg 16.28 lb	120.651 4.7500	131401CD : GROOVE IN OD CENTER HOLES IN OD CENTER
*EE130850DW	215.900 8.5000	120.650 4.7500	1.5 .06	39.45 kg 86.98 lb							131402D : GROOVE IN OD CENTER HOLES IN OD CENTER
EE130887D	225.425 8.8750	120.650 4.7500	5.5 .22	36.46 kg 80.40 lb							131500DA : HOLES IN OD CENTER SPECIAL RADIUS ON LEFTFACE OD SPECIAL RADIUS ON RIGHTFACE OD
EE130900D	228.600 9.0000	120.650 4.7500	1.5 .06	35.24 kg 77.71 lb							
EE130901D	228.600 9.0000	120.650 4.7500	5.5 .22	35.24 kg 77.71 lb							
EE130904D	228.600 9.0000	127.000 5.0000	1.5 .06	35.72 kg 78.77 lb							
*NA130858T	224.003 8.8190	73.025 2.8750	6.4 .25	- -	*131398D	354.950 13.9744	109.952 4.3288	1.5 .06	6.87 kg 15.14 lb	146.050 5.7500	
NA130902	228.600 9.0000	73.025 2.8750	6.4 .25	- -	*131400DA	355.600 14.0000	111.125 4.3750	.8 .03	17.07 kg 37.64 lb	146.050 5.7500	
*NA130906T	230.104 9.0592	73.025 2.8750	6.4 .25	- -	*131401CD	355.600 14.0000	111.125 4.3750	1.5 .06	16.36 kg 36.07 lb	146.050 5.7500	
					*131402D	355.600 14.0000	117.475 4.6250	.8 .03	17.78 kg 39.20 lb	146.050 5.7500	
					*131500DA	381.000 15.0000	111.125 4.3750	1.5 .06	28.24 kg 62.26 lb	146.050 5.7500	
EE130888D	225.425 8.8750	165.100 6.5000	8.0 .31	44.95 kg 99.12 lb	EE130888D and grouped cones may be paired with all single cups corresponding to EE130850D and will require 44.450 mm (1.7500 in) to be added to the T-width values.						
EE130903D	228.600 9.0000	165.100 6.5000	8.0 .31	43.17 kg 95.19 lb							
*EE130926TD	234.950 9.2500	165.100 6.5000	1.5 .06	44.31 kg 97.71 lb							
NA130907	229.974 9.0541	72.184 2.8419	6.4 .25	- -	NA130907 may be paired with all double cups corresponding to NA130858T and will require -1.681 mm (-.0662 in) to be added to the T-width values.						
*EE130927TD	234.950 9.2500	184.150 7.2500	1.5 .06	46.97 kg 103.56 lb	EE130927TD may be paired with all single cups corresponding to EE130850D and will require 63.500 mm (2.5000 in) to be added to the T-width values.						

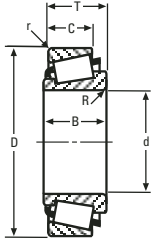

SINGLE ROW

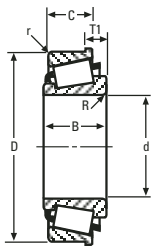

SINGLE ROW WITH FLANGE

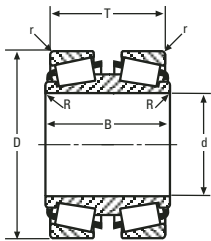

DOUBLE CONE

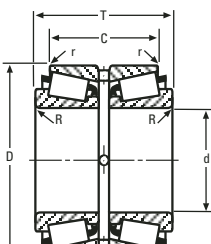

DOUBLE CUP

132000 – HM133400 SERIES

CONE			Max Shaft Fillet Radii R''	Weight	CUP			Max Hs'ng Fillet Radii r''	Weight	BEAR-ING	Remarks
Number	BORE d	WIDTH B			Number	OUTSIDE DIA D	WIDTH C			WIDTH T	
<b>132000 Series</b>											
EE132081D	203.200 8.0000	95.250 3.7500	3.3 .13	22.42 kg 49.43 lb	132125	317.500 12.5000	34.925 1.3750	3.3 .13	4.13 kg 9.11 lb	95.250 3.7500	EE132082D: EXTENDED SMALL RIB
*EE132082D	203.200 8.0000	101.600 4.0000	3.3 .13	22.79 kg 50.24 lb	132127	319.088 12.5625	34.925 1.3750	3.3 .13	4.35 kg 9.59 lb	95.250 3.7500	132126D : GROOVE IN OD CENTER HOLES IN OD CENTER
EE132083	203.200 8.0000	53.975 2.1250	4.0 .16	9.81 kg 21.63 lb	132125	317.500 12.5000	34.925 1.3750	3.3 .13	4.13 kg 9.11 lb	53.975 2.1250	132126DC : HOLES IN OD CENTER
EE132084	206.375 8.1250	53.975 2.1250	4.0 .16	9.38 kg 20.68 lb	*132126DC	317.500 12.5000	88.900 3.5000	1.5 .06	13.42 kg 29.60 lb	127.000 5.0000	
					*132126D	317.500 12.5000	88.900 3.5000	1.5 .06	13.42 kg 29.60 lb	127.000 5.0000	
					132127	319.088 12.5625	34.925 1.3750	3.3 .13	4.35 kg 9.59 lb	53.975 2.1250	
NA132083	203.200 8.0000	60.325 2.3750	6.4 .25	- -	*132126DC	317.500 12.5000	88.900 3.5000	1.5 .06	13.42 kg 29.60 lb	120.650 4.7500	
					*132126D	317.500 12.5000	88.900 3.5000	1.5 .06	13.42 kg 29.60 lb	120.650 4.7500	
<b>133000 Series</b>											
EE133136D	343.052 13.5060	120.650 4.7500	1.5 .06	41.16 kg 90.75 lb	133180	457.098 17.9960	47.625 1.8750	3.3 .13	8.91 kg 19.65 lb	120.650 4.7500	
EE133137D	346.075 13.6250	120.650 4.7500	1.5 .06	39.61 kg 87.34 lb							
<b>HM133400 Series</b>											
HM133432	144.450 5.6870	69.850 2.7500	1.5 .06	9.63 kg 21.24 lb	*HM133413YDA	249.872 9.8375	160.000 6.2992	-	11.91 kg 26.26 lb	153.764 6.0537	HM133436H: MADE FROM VACUUM MELT STEEL
HM133436	149.967 5.9042	69.850 2.7500	3.0 .12	8.92 kg 19.68 lb	*HM133413YD	249.872 9.8375	160.000 6.2992	1.3 .05	11.91 kg 26.26 lb	153.764 6.0537	HM133413XD : SPECIAL CHAMFER ON LEFTFACE OD SPECIAL CHAMFER ON RIGHTFACE OD
*HM133436H	149.967 5.9042	69.850 2.7500	3.0 .12	8.94 kg 19.71 lb	*HM133413YDC	249.872 9.8375	160.000 6.2992	1.3 .05	11.54 kg 25.46 lb	153.764 6.0537	HM133413YD : HOLES IN OD CENTER SPECIAL CHAMFER ON LEFTFACE OD
HM133436XH	149.967 5.9042	69.850 2.7500	3.0 .12	8.92 kg 19.68 lb	*HM133413YDV	249.872 9.8375	160.000 6.2992	spcl. spcl.	11.29 kg 24.89 lb	153.764 6.0537	SPECIAL CHAMFER ON RIGHTFACE OD
HM133444	157.150 6.1870	69.850 2.7500	1.5 .06	7.99 kg 17.62 lb	*HM133413XD	249.872 9.8375	160.000 6.2992	1.3 .05	11.98 kg 26.42 lb	153.764 6.0537	HM133413YDA : HOLES IN OD CENTER
HM133448	160.000 6.2992	69.850 2.7500	1.5 .06	7.60 kg 16.77 lb	*HM133414YDX	249.872 9.8375	185.000 7.2835	1.3 .05	14.09 kg 31.07 lb	178.650 7.0335	HM133413YD : HOLES IN OD CENTER SPECIAL CHAMFER ON LEFTFACE OD
†JHM133449	160.000 6.2992	69.850 2.7500	1.5 .06	7.60 kg 16.77 lb	*HM133414YD	249.872 9.8375	185.000 7.2835	1.3 .05	14.10 kg 31.10 lb	178.765 7.0380	SPECIAL CHAMFER ON RIGHTFACE OD
					*HM133414YDS	249.872 9.8375	185.000 7.2835	1.3 .05	14.09 kg 31.07 lb	178.765 7.0380	HM133413YDV : GROOVE IN OD CENTER HOLES IN OD CENTER
					*HM133414YDV	249.872 9.8375	185.000 7.2835	1.3 .05	14.09 kg 31.07 lb	178.765 7.0380	SPECIAL RADIUS ON LEFT FACE OD SPECIAL RADIUS ON RIGHTFACE OD
					*HM133415YD	252.412 9.9375	184.150 7.2500	1.3 .05	14.11 kg 31.11 lb	177.914 7.0045	HM133414YD : HOLES IN OD CENTER SPECIAL CHAMFER ON LEFTFACE OD
					*HM133416XD	252.412 9.9375	184.150 7.2500	1.3 .05	15.45 kg 34.07 lb	177.914 7.0045	SPECIAL CHAMFER ON RIGHTFACE OD
					*HM133416YD	252.412 9.9375	184.150 7.2500	1.3 .05	14.02 kg 30.90 lb	177.914 7.0045	HM133414YDS : HOLES IN OD CENTER MADE FROM VACUUM MELT STEEL
					HM133416	252.412 9.9375	52.388 2.0625	3.3 .13	4.30 kg 9.48 lb	63.500 2.5000	SPECIAL CHAMFER ON LEFTFACE OD SPECIAL CHAMFER ON RIGHTFACE OD
					*HM133416D	252.412 9.9375	184.150 7.2500	1.3 .05	13.36 kg 29.45 lb	177.914 7.0045	HM133414YDV : HOLES IN OD CENTER MADE FROM VACUUM MELT STEEL
					†JHM133417	255.000 10.0394	52.388 2.0625	3.3 .13	4.72 kg 10.41 lb	63.500 2.5000	SPECIAL CHAMFER ON LEFTFACE OD SPECIAL CHAMFER ON RIGHTFACE OD
					HM133420XD	260.350 10.2500	177.800 7.0000	1.5 .06	17.96 kg 39.61 lb	152.400 6.0000	HM133414YDX : HOLES IN OD CENTER SPECIAL CHAMFER ON LEFTFACE OD SPECIAL CHAMFER ON RIGHTFACE OD

6

\*\*These Maximum Fillet Radii will be cleared by the Cone or Cup Radii.  
†Bore or O.D. shown are maximum dimensions. \*See Remarks Column.

HM133400 – M144400 SERIES

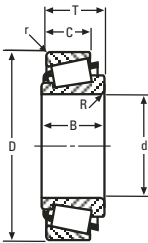
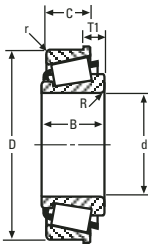
CONE			Max Shaft Fillet Radii R <sup>**</sup>	Weight	CUP			Max Hs'ng Fillet Radii r <sup>**</sup>	Weight	BEARING	Remarks
Number	BORE d	WIDTH B			Number	OUTSIDE DIA D	WIDTH C			WIDTH T	
HM133400 Series (cont)											
 <p><b>SINGLE ROW</b></p>											
 <p><b>SINGLE ROW WITH FLANGE</b></p>											
<b>134000 Series</b>											
EE134100	254.000 10.0000	58.738 2.3125	6.4 .25	12.80 kg 28.21 lb	134143	365.125 14.3750	42.862 1.6875	6.4 .25	5.23 kg 11.54 lb	58.738 2.3125	HM133415VD : HOLES IN OD CENTER SPECIAL CHAMFER ON LEFTFACE OD SPECIAL CHAMFER ON RIGHTFACE OD
EE134102	260.350 10.2500	58.738 2.3125	6.4 .25	11.61 kg 25.61 lb	*134144CD	365.125 14.3750	98.425 3.8750	1.5 .06	12.30 kg 27.12 lb	130.175 5.1250	HM133416D : GROOVE IN OD CENTER HOLES IN OD CENTER SPECIAL CHAMFER ON LEFTFACE OD SPECIAL CHAMFER ON RIGHTFACE OD
					134145	368.300 14.5000	42.862 1.6875	6.4 .25	5.84 kg 12.89 lb	58.738 2.3125	HM133416XD : SPECIAL CHAMFER ON LEFTFACE OD SPECIAL CHAMFER ON RIGHTFACE OD
EE134102D	260.350 10.2500	107.950 4.2500	3.3 .13	27.12 kg 59.80 lb	134143	365.125 14.3750	42.862 1.6875	6.4 .25	5.23 kg 11.54 lb	107.950 4.2500	HM133416VD : HOLES IN OD CENTER SPECIAL CHAMFER ON LEFTFACE OD SPECIAL CHAMFER ON RIGHTFACE OD
					134145	368.300 14.5000	42.862 1.6875	6.4 .25	5.84 kg 12.89 lb	107.950 4.2500	HM134144CD : GROOVE IN OD CENTER HOLES IN OD CENTER
<b>135000 Series</b>											
*EE13511DVGW	279.400 11.0000	127.000 5.0000	1.5 .06	37.64 kg 82.99 lb	135155	393.700 15.5000	50.800 2.0000	6.4 .25	6.71 kg 14.80 lb	127.000 5.0000	EE13511DVGW : GROOVE IN ID
EE13511DVGW	279.400 11.0000	127.000 5.0000	1.5 .06	37.69 kg 83.11 lb							
<b>HM136900 Series</b>											
HM136936	157.150 6.1870	74.612 2.9375	1.5 .06	25.23 kg 55.63 lb	*HM136916XDV	276.225 10.8750	185.725 7.3120	-	18.02 kg 39.73 lb	181.022 7.1269	HM136948V : MADE FROM VACUUM MELT STEEL
HM136940	165.087 6.4995	74.612 2.9375	1.5 .06	22.88 kg 50.46 lb	HM136916XD	276.225 10.8750	185.725 7.3120	-	18.02 kg 39.73 lb	181.022 7.1269	HM136916D : GROOVE IN OD CENTER HOLES IN OD CENTER
HM136948	177.787 6.9995	74.612 2.9375	1.5 .06	18.89 kg 41.66 lb	*HM136916D	276.225 10.8750	185.725 7.3120	-	17.12 kg 37.74 lb	181.022 7.1269	HM136916XDV : MADE FROM VACUUM MELT STEEL
*HM136948V	177.787 6.9995	74.612 2.9375	1.5 .06	18.81 kg 41.48 lb							
<b>138000 Series</b>											
EE138131D	330.302 13.0040	114.300 4.5000	1.5 .06	36.49 kg 80.46 lb	138172	438.023 17.2450	47.625 1.8750	3.3 .13	8.05 kg 17.75 lb	120.650 4.7500	
<b>140000 Series</b>											
*141250D	317.500 12.5000	195.250 7.6870	1.5 .06	-	142551	647.700 25.5000	85.725 3.3750	3.3 .13	41.99 kg 92.59 lb	205.130 8.0760	141250D : NO SMALL RIB
EE141250D	317.500 12.5000	195.250 7.6870	1.5 .06	-	142653	673.100 26.5000	95.250 3.7500	3.3 .13	65.07 kg 143.49 lb	205.131 8.0760	
EE141251D	317.500 12.5000	195.250 7.6870	.8 .03	-							
<b>M144400 Series</b>											
*M144443DVGW	220.662 8.6875	120.366 4.7388	1.5 .06	23.15 kg 51.04 lb	*M144414X	314.325 12.3750	52.189 2.0547	1.5 .06	3.94 kg 8.69 lb	122.767 4.8334	M144443DVGW : ASYMMETRICAL BEARING EXTENDED SMALL RIB GROOVE IN ID SHOULDER ON ID LEFTSIDE M144414X : SHOULDER ON OD BACKFACE

HH144600 SERIES CONTINUED ON NEXT PAGE

\*\*These Maximum Fillet Radii will be cleared by the Cone or Cup Radii.  
†Bore or O.D. shown are maximum dimensions. \*See Remarks Column.



HH144600 – L163100 SERIES

6

CONE			Max Shaft Fillet Radii R''	Weight	CUP			Max Hs'ng Fillet Radii r''	Weight	BEARING	Remarks
Number	BORE d	WIDTH B			Number	OUTSIDE DIA D	WIDTH C			WIDTH T	
HH144600 Series											
HH144642	200.025 7.8750	111.125 4.3750	6.4 .25	40.44 kg 89.18 lb	HH144614	393.700 15.5000	84.138 3.3125	6.4 .25	20.21 kg 44.56 lb	111.125 4.3750	
147000 Series											
EE147112	285.750 11.2500	88.900 3.5000	6.4 .25	- -	*147198DC	501.650 19.7500	120.650 4.7500	3.3 .13	43.89 kg 96.79 lb	203.200 8.0000	147198D : GROOVE IN OD CENTER HOLES IN OD CENTER
					*147198D	501.650 19.7500	120.650 4.7500	3.3 .13	43.56 kg 96.04 lb	203.200 8.0000	147198DC : HOLES IN OD CENTER
148000 Series											
EE148122	311.150 12.2500	82.550 3.2500	9.7 .38	- -	*148220D	558.800 22.0000	111.125 4.3750	3.3 .13	71.61 kg 157.90 lb	190.500 7.5000	148220D : GROOVE IN OD CENTER HOLES IN OD CENTER
153000 Series											
EE153044	120.650 4.7500	82.550 3.2500	9.7 .38	12.32 kg 27.16 lb	153100	254.000 10.0000	57.150 2.2500	6.4 .25	5.87 kg 12.94 lb	77.788 3.0625	153103D : GROOVE IN OD CENTER HOLES IN OD CENTER
EE153049	123.825 4.8750	82.550 3.2500	9.7 .38	11.91 kg 26.26 lb	153101	258.763 10.1875	57.150 2.2500	6.4 .25	6.72 kg 14.82 lb	77.788 3.0625	
EE153050	127.000 5.0000	82.550 3.2500	9.7 .38	11.51 kg 25.37 lb	153102	260.350 10.2500	57.150 2.2500	6.4 .25	7.01 kg 15.46 lb	77.788 3.0625	
					*153103D	258.763 10.1875	136.525 5.3750	1.5 .06	17.33 kg 38.22 lb	177.800 7.0000	
EE153048D	123.825 4.8750	171.450 6.7500	11.2 .44	29.86 kg 65.83 lb	153100	254.000 10.0000	57.150 2.2500	6.4 .25	5.87 kg 12.94 lb	161.925 6.3750	
					153101	258.763 10.1875	57.150 2.2500	6.4 .25	6.72 kg 14.82 lb	161.925 6.3750	
					153102	260.350 10.2500	57.150 2.2500	6.4 .25	7.01 kg 15.46 lb	161.925 6.3750	
154000 Series											
EE154512	130.000 5.1181	82.000 3.2284	10.0 .39	12.23 kg 26.97 lb	154103	262.000 10.3150	58.000 2.2835	6.4 .25	6.24 kg 13.77 lb	78.000 3.0709	
157000 Series											
EE157337	857.250 33.7500	111.125 4.3750	19.0 .75	- -	157430	1092.200 43.0000	76.200 3.0000	6.4 .25	70.52 kg 155.50 lb	120.650 4.7500	
158000 Series											
EE158350	889.000 35.0000	111.125 4.3750	19.0 .75	- -	158442	1123.950 44.2500	76.200 3.0000	6.4 .25	73.14 kg 161.28 lb	120.650 4.7500	
HH159800 Series											
*HH159849E	304.800 12.0000	188.000 7.4016	8.0 .31	- -	HH159810	546.100 21.5000	128.064 5.0419	8.0 .31	49.67 kg 109.53 lb	159.128 6.2649	HH159849E: EXTENDED SMALL RIB
160000 Series											
EE161300	330.200 13.0000	55.562 2.1875	7.0 .28	23.61 kg 52.06 lb	161850	469.900 18.5000	38.100 1.5000	6.4 .25	5.85 kg 12.90 lb	60.325 2.3750	161901CD : GROOVE IN OD CENTER HOLES IN OD CENTER
EE161363	346.075 13.6250	55.562 2.1875	7.0 .28	19.94 kg 43.96 lb	161900	482.600 19.0000	38.100 1.5000	6.4 .25	8.68 kg 19.13 lb	60.325 2.3750	
EE161394	354.012 13.9375	55.562 2.1875	7.0 .28	18.04 kg 39.77 lb	*161901CD	482.600 19.0000	88.900 3.5000	1.5 .06	20.55 kg 45.30 lb	133.350 5.2500	
EE161400	355.600 14.0000	55.562 2.1875	7.0 .28	17.65 kg 38.92 lb	16192	488.950 19.2500	38.100 1.5000	6.4 .25	10.12 kg 22.30 lb	60.325 2.3750	
EE161362D	346.075 13.6250	95.250 3.7500	1.5 .06	41.25 kg 90.96 lb	161850	469.900 18.5000	38.100 1.5000	6.4 .25	5.85 kg 12.90 lb	104.775 4.1250	
EE161403D	356.387 14.0310	101.600 4.0000	1.5 .06	38.37 kg 84.61 lb	161900	482.600 19.0000	38.100 1.5000	6.4 .25	8.68 kg 19.13 lb	104.775 4.1250	
					161925	488.950 19.2500	38.100 1.5000	6.4 .25	10.12 kg 22.30 lb	104.775 4.1250	
L163100 Series											
L163149	355.600 14.0000	60.325 2.3750	3.5 .14	14.01 kg 30.89 lb	L163110	444.500 17.5000	47.625 1.8750	3.3 .13	6.75 kg 14.88 lb	60.325 2.3750	L163149D: ASYMMETRICAL BEARING SHOULDER ON OD RIGHTFACE
					*L163110CD	444.500 17.5000	111.125 4.3750	1.5 .06	17.27 kg 38.09 lb	136.524 5.3750	L163110CD : GROOVE IN OD CENTER HOLES IN OD CENTER
					†JL163115	460.000 18.1102	47.625 1.8750	3.5 .14	10.97 kg 24.19 lb	60.325 2.3750	

\*\*These Maximum Fillet Radii will be cleared by the Cone or Cup Radii.  
†Bore or O.D. shown are maximum dimensions. \*See Remarks Column.

**L163100 – 180000 SERIES**

CONE			Max Shaft Fillet Radii R <sup>**</sup>	Weight	CUP			Max H's'ng Fillet Radii r <sup>**</sup>	Weight	BEAR-ING	Remarks
Number	BORE d	WIDTH B			Number	OUTSIDE DIA D	WIDTH C			WIDTH T	
<b>L163100 Series (cont)</b>											
*L163149D	355.600 14.0000	114.300 4.5000	1.5 .06	34.42 kg 75.89 lb	L163110 444.500 17.5000	47.625 1.8750	3.3 .13	6.75 kg 14.88 lb	112.712 4.4375		
†JL163142D	340.000 13.3858	118.000 4.6457	3.5 .14	42.41 kg 93.51 lb	†JL163115 460.000 18.1102	47.625 1.8750	3.5 .14	10.97 kg 24.19 lb	112.712 4.4375	JL163142D may be paired with all single cups corresponding to L163149D and will require 5.651 mm (.2225 in) to be added to the T-width values.	
<b>168000 Series</b>											
EE168399	1014.412 39.9375	101.600 4.0000	9.7 .38	- -	168500V 1270.000 50.0000	66.675 2.6250	9.7 .38	76.84 kg 169.43 lb	101.600 4.0000		
EE168400	1016.000 40.0000	101.600 4.0000	9.7 .38	- -	168500 1270.000 50.0000	66.675 2.6250	9.7 .38	76.84 kg 169.43 lb	101.600 4.0000		
EE168400V	1016.000 40.0000	101.600 4.0000	9.7 .38	- -							
<b>LM169300 Series</b>											
LM169345DGW	431.800 17.0000	168.275 6.6250	1.5 .06	90.50 kg 199.55 lb	*LM169313W 571.500 22.5000	66.675 2.6250	6.4 .25	15.09 kg 33.28 lb	158.369 6.2350	LM169313W : SLOTS IN BACKFACE	
					LM169313X 571.500 22.5000	74.079 2.9165	- -	16.35 kg 36.06 lb	173.177 6.8180		
<b>170000 Series</b>											
EE170950	241.300 9.5000	50.800 2.0000	6.4 .25	12.01 kg 26.47 lb	171400 355.600 14.0000	33.338 1.3125	3.3 .13	3.82 kg 8.42 lb	50.800 2.0000	171451CD : GROOVE IN OD CENTER HOLES IN OD CENTER	
EE170975	247.650 9.7500	50.800 2.0000	6.4 .25	11.03 kg 24.33 lb	171436 365.049 14.3720	33.338 1.3125	3.3 .13	5.21 kg 11.49 lb	50.800 2.0000		
					171450 368.300 14.5000	33.338 1.3125	3.3 .13	5.70 kg 12.57 lb	50.800 2.0000		
					*171451CD 368.300 14.5000	85.725 3.3750	1.5 .06	14.73 kg 32.48 lb	120.650 4.7500		
NA170950	241.300 9.5000	60.325 2.3750	6.4 .25	- -	*171451CD 368.300 14.5000	85.725 3.3750	1.5 .06	14.73 kg 32.48 lb	120.650 4.7500		
EE171000D	254.000 10.0000	92.862 3.6560	1.5 .06	22.72 kg 50.09 lb	171400 355.600 14.0000	33.338 1.3125	3.3 .13	3.82 kg 8.42 lb	92.710 3.6500		
					171436 365.049 14.3720	33.338 1.3125	3.3 .13	5.21 kg 11.49 lb	92.710 3.6500		
					171450 368.300 14.5000	33.338 1.3125	3.3 .13	5.70 kg 12.57 lb	92.710 3.6500		
<b>LM170400 Series</b>											
*LM170447DGW	449.948 17.7145	184.000 7.2441	.0 .00	109.46 kg 241.35 lb	*LM170414W 594.949 23.4232	74.468 2.9318	6.0 .24	19.27 kg 42.49 lb	177.079 6.9716	LM170447DGW : ASYMMETRICAL BEARING GROOVE IN ID SHOULDER ON ID RIGHTSIDE	
					*LM170414X 594.949 23.4232	78.900 3.1063	2.0 .08	19.29 kg 42.54 lb	185.943 7.3206	LM170414W : SLOTS IN BACKFACE LM170414X : SHOULDER ON OD BACKFACE	
<b>175000 Series</b>											
EE175301	762.000 30.0000	63.500 2.5000	3.3 .13	38.75 kg 85.45 lb	175350 889.000 35.0000	50.800 2.0000	3.3 .13	23.57 kg 51.97 lb	63.500 2.5000		
EE175300	762.000 30.0000	69.850 2.7500	3.3 .13	42.19 kg 93.03 lb	EE175300 may be paired with all single cups corresponding to EE175301 and will require 6.350 mm (.2500 in) to be added to the T-width values.						
<b>180000 Series</b>											
*181450D	368.300 14.5000	146.050 5.7500	6.4 .25	- -	182350 596.900 23.5000	60.325 2.3750	6.4 .25	25.66 kg 56.58 lb	165.100 6.5000	181450D : NO SMALL RIB EE181454DW : KEYWAY IN ID	
EE181454D	368.300 14.5000	158.750 6.2500	6.4 .25	- -						182351D : GROOVE IN OD CENTER HOLES IN OD CENTER	
*EE181454DW	368.300 14.5000	158.750 6.2500	6.4 .25	- -						182351DC : HOLES IN OD CENTER	
EE181453	368.300 14.5000	92.075 3.6250	9.7 .38	- -	182350 596.900 23.5000	60.325 2.3750	6.4 .25	25.66 kg 56.58 lb	95.250 3.7500		
					*182351DC 596.900 23.5000	133.350 5.2500	2.3 .09	59.18 kg 130.49 lb	203.200 8.0000		
					*182351D 596.900 23.5000	133.350 5.2500	2.3 .09	59.18 kg 130.49 lb	203.200 8.0000		

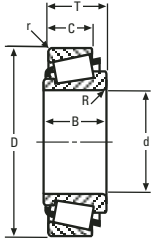

**SINGLE ROW**



**SINGLE ROW WITH FLANGE**

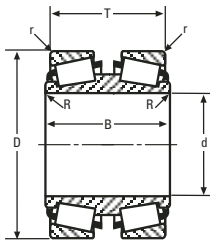

**DOUBLE CONE**

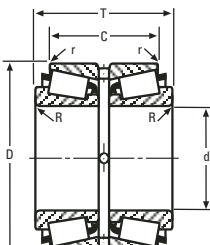

**DOUBLE CUP**

L183400 – LL205400 SERIES

6

CONE			Max Shaft Fillet Radii R''	Weight	CUP			Max Hs'ng Fillet Radii r''	Weight	BEAR-ING	Remarks
Number	BORE d	WIDTH B			Number	OUTSIDE DIA D	WIDTH C			WIDTH T	
<b>L183400 Series</b>											
L183448	759.925 29.9183	88.900 3.5000	3.3 .13	65.52 kg 144.48 lb	L183410	889.000 35.0000	72.000 2.8346	3.3 .13	24.45 kg 53.90 lb	88.900 3.5000	
L183449	762.000 30.0000	88.900 3.5000	3.3 .13	63.80 kg 140.68 lb							
<b>188000 Series</b>											
EE188530	1346.200 53.0000	98.425 3.8750	9.7 .38	- -	*188621	1574.800 62.0000	66.675 2.6250	1.5 .06	78.72 kg 173.57 lb	98.425 3.8750	188621 : SHOULDER ON OD BACKFACE SPECIAL RADIUS ON BACKFACE OD
<b>192000 Series</b>											
EE192148	377.825 14.8750	58.738 2.3125	6.4 .25	21.13 kg 46.58 lb	192200	508.000 20.0000	38.100 1.5000	3.3 .13	9.34 kg 20.59 lb	63.500 2.5000	EE192155W: KEYWAY IN ID
EE192150	381.000 15.0000	58.738 2.3125	6.4 .25	20.26 kg 44.66 lb	*192201CD	508.000 20.0000	88.900 3.5000	1.5 .06	22.63 kg 49.90 lb	139.700 5.5000	192201CD : GROOVE IN OD CENTER HOLES IN OD CENTER
*EE192155W	377.825 14.8750	58.738 2.3125	6.4 .25	20.29 kg 44.73 lb							
<b>195000 Series</b>											
EE195500X	127.000 5.0000	67.335 2.6510	4.8 .19	16.62 kg 36.65 lb	195116X	295.275 11.6250	50.800 2.0000	4.8 .19	10.23 kg 22.55 lb	82.550 3.2500	
<b>197000 Series</b>											
EE197045	114.300 4.5000	74.612 2.9375	3.3 .13	11.70 kg 25.80 lb	197100	254.000 10.0000	49.212 1.9375	6.4 .25	6.49 kg 14.30 lb	77.787 3.0625	
<b>200000 Series</b>											
EE201250	317.500 12.5000	65.088 2.5625	6.8 .27	21.43 kg 47.25 lb	201800	457.200 18.0000	42.862 1.6875	6.8 .27	9.18 kg 20.25 lb	66.675 2.6250	
<b>M201000 Series</b>											
M201047	39.688 1.5625	22.098 .8700	.8 .03	.26 kg .58 lb	M201011	73.025 2.8750	21.336 .8400	2.3 .09	.17 kg .36 lb	25.654 1.0100	
M201047-S	39.688 1.5625	22.098 .8700	.8 .03	.26 kg .58 lb							
<b>203000 Series</b>											
EE203130	330.200 13.0000	63.500 2.5000	6.8 .27	26.12 kg 57.58 lb	*203190-B	482.600 19.0000	44.450 1.7500	6.8 .27	11.13 kg 24.55 lb	36.513 1.4375	203190-B : FLANGE ON OD FRONTFACE, BEARING WIDTH IS T1 DIMENSION
EE203136	346.075 13.6250	63.500 2.5000	6.8 .27	21.92 kg 48.33 lb	203190	482.600 19.0000	44.450 1.7500	6.8 .27	9.58 kg 21.13 lb	66.675 2.6250	
EE203137	346.075 13.6250	63.500 2.5000	12.7 .50	21.42 kg 47.23 lb							
<b>204000 Series</b>											
*EE204135DW	342.900 13.5000	127.000 5.0000	1.5 .06	58.43 kg 128.84 lb	204190	482.600 19.0000	53.183 2.0938	3.3 .13	11.04 kg 24.35 lb	131.766 5.1876	EE204135DW: KEYWAY IN ID
EE204140D	355.600 14.0000	127.000 5.0000	1.5 .06	50.89 kg 112.22 lb							
<b>HM204000 Series</b>											
*HM204043	39.987 1.5743	32.000 1.2598	1.0 .04	.73 kg 1.61 lb	HM204010	90.975 3.5817	26.500 1.0433	3.5 .14	.30 kg .67 lb	32.000 1.2598	HM204043: FRONTFACE CHAMFER
*HM204049	45.987 1.8105	32.000 1.2598	3.5 .14	.62 kg 1.36 lb	*HM204010W	90.975 3.5817	26.500 1.0433	3.5 .14	.30 kg .67 lb	32.000 1.2598	HM204049: FRONTFACE CHAMFER HM204010W : KEYWAY IN OD BACKFACE
<b>M205100 Series</b>											
†JM205149	50.000 1.9685	28.000 1.1024	3.0 .12	.51 kg 1.12 lb	†JM205110	90.000 3.5433	23.000 .9055	2.5 .10	.24 kg .53 lb	28.000 1.1024	JM205149V: MADE FROM SPECIAL STEEL
†JM205149A	50.000 1.9685	28.000 1.1024	5.0 .20	.50 kg 1.11 lb	†JM205110A	90.000 3.5433	23.000 .9055	.8 .03	.24 kg .53 lb	28.000 1.1024	JM205110V : MADE FROM SPECIAL STEEL
†JM205149AS	50.000 1.9685	28.000 1.1024	2.5 .10	.51 kg 1.12 lb	*†JM205110V	90.000 3.5433	23.000 .9055	2.5 .10	.24 kg .53 lb	28.000 1.1024	
*†JM205149V	50.000 1.9685	28.000 1.1024	3.0 .12	.50 kg 1.09 lb							
<b>LL205400 Series</b>											
LL205442	46.038 1.8125	12.700 .5000	1.5 .06	.18 kg 40 lb	*LL205410-B	77.788 3.0625	9.525 .3750	1.5 .06	.07 kg .16 lb	5.969 .2350	LL205410-B : FLANGE ON OD FRONTFACE, BEARING WIDTH IS T1 DIMENSION
LL205449	50.800 2.0000	12.700 .5000	1.5 .06	.14 kg .32 lb	LL205410	77.788 3.0625	9.525 .3750	1.5 .06	.06 kg .13 lb	12.700 .5000	SPECIAL RADIUS ON BACKFACE OD
LL205449A	50.800 2.0000	12.700 .5000	3.0 .12	.14 kg .32 lb							
LL205449AA	50.800 2.0000	12.700 .5000	3.5 .14	.14 kg .31 lb							

†These Maximum Fillet Radii will be cleared by the Cone or Cup Radii.  
†Bore or O.D. shown are maximum dimensions. \*See Remarks Column.

M20700 – 217000 SERIES

CONE			Max Shaft Fillet Radii R <sup>**</sup>	Weight	CUP			Max Hs'ng Fillet Radii r <sup>**</sup>	Weight	BEARING WIDTH T	Remarks
Number	BORE d	WIDTH B			Number	OUTSIDE DIA D	WIDTH C				
<b>M207000 Series</b>											
†JM207049	55.000 2.1654	29.000 1.1417	1.5 .06	.59 kg 1.29 lb	†JM207010	95.000 3.7402	23.500 .9252	2.5 .10	.25 kg .56 lb	29.000 1.1417	
†JM207049A	55.000 2.1654	29.000 1.1417	6.0 .24	.56 kg 1.24 lb	†JM207010A	95.000 3.7402	24.500 .9646	2.0 .08	.28 kg .62 lb	30.000 1.1811	
<b>210000 Series</b>											
EE210700D	177.800 7.0000	107.950 4.2500	1.5 .06	33.46 kg 73.78 lb	211300	330.200 13.0000	42.862 1.6875	3.3 .13	6.68 kg 14.72 lb	111.125 4.3750	
EE210750D	190.500 7.5000	107.950 4.2500	3.3 .13	30.35 kg 66.92 lb							
EE210752D	190.500 7.5000	114.300 4.5000	3.3 .13	30.75 kg 67.81 lb							
EE210753	190.500 7.5000	61.912 2.4375	7.0 .28	13.17 kg 29.03 lb	211300	330.200 13.0000	42.862 1.6875	3.3 .13	6.68 kg 14.72 lb	63.500 2.5000	
					211301XD	330.200 13.0000	98.425 3.8750	1.5 .06	16.22 kg 35.77 lb	139.700 5.5000	
<b>H211700 Series</b>											
†JH211749	65.000 2.5591	38.500 1.5157	3.0 .12	1.25 kg 2.76 lb	†JH211710	120.000 4.7244	32.000 1.2598	2.5 .10	.61 kg 1.36 lb	39.000 1.5354	
†JH211749A	65.000 2.5591	38.500 1.5157	7.0 .28	1.22 kg 2.68 lb							
†JH211749E	65.000 2.5591	44.000 1.7323	3.0 .12	1.74 kg 3.84 lb							JH211749E may be paired with all single cups corresponding to JH211749 and will require 1.000 mm (.0394 in) to be added to the T-width values.
<b>HM212000 Series</b>											
HM212044	60.325 2.3750	38.354 1.5100	8.0 .31	1.45 kg 3.19 lb	HM212010	122.238 4.8125	29.718 1.1700	1.5 .06	.60 kg 1.32 lb	38.100 1.5000	HM212049V: MADE FROM VACUUM MELT STEEL HM212011V: MADE FROM VACUUM MELT STEEL
HM212046	63.500 2.5000	38.354 1.5100	3.5 .14	1.37 kg 3.02 lb	HM212011	122.238 4.8125	29.718 1.1700	3.3 .13	.60 kg 1.32 lb	38.100 1.5000	
HM212046C	63.500 2.5000	38.354 1.5100	3.5 .14	1.37 kg 3.02 lb	*HM212011V	122.238 4.8125	29.718 1.1700	3.3 .13	.59 kg 1.29 lb	38.100 1.5000	
HM212047	63.500 2.5000	38.354 1.5100	7.0 .28	1.36 kg 2.99 lb							
HM212049	66.675 2.6250	38.354 1.5100	3.5 .14	1.27 kg 2.80 lb							
HM212049A	66.675 2.6250	38.354 1.5100	5.5 .22	1.26 kg 2.79 lb							
*HM212049V	66.675 2.6250	38.354 1.5100	3.5 .14	1.27 kg 2.80 lb							
HM212049X	66.675 2.6250	38.354 1.5100	7.0 .28	1.26 kg 2.77 lb							
<b>H212700 Series</b>											
H212749	65.987 2.5979	41.500 1.6339	7.0 .28	1.46 kg 3.21 lb	H212710	123.975 4.8809	34.000 1.3386	3.5 .14	.67 kg 1.47 lb	41.500 1.6339	
<b>213000 Series</b>											
EE213362	92.075 3.6250	73.025 2.8750	9.7 .38	7.88 kg 17.37 lb	213843	214.312 8.4375	53.975 2.1250	6.4 .25	4.45 kg 9.81 lb	73.025 2.8750	
<b>215000 Series</b>											
*EE215040	101.600 4.0000	73.025 2.8750	6.4 .25	10.44 kg 23.03 lb	215096	250.825 9.8750	50.800 2.0000	3.3 .13	6.90 kg 15.22 lb	76.200 3.0000	EE215040: EXTENDED LARGE RIB
					215098	250.825 9.8750	50.800 2.0000	6.4 .25	6.81 kg 15.02 lb	76.200 3.0000	
<b>HM215200 Series</b>											
HM215249	75.987 2.9916	39.000 1.5354	7.0 .28	1.46 kg 3.21 lb	HM215210	131.976 5.1959	32.000 1.2598	3.5 .14	.65 kg 1.44 lb	39.000 1.5354	
<b>217000 Series</b>											
EE217056	146.050 5.7500	73.025 2.8750	6.4 .25	12.91 kg 28.46 lb	217112	285.750 11.2500	55.562 2.1875	6.4 .25	7.36 kg 16.22 lb	76.200 3.0000	
EE217060	152.400 6.0000	73.025 2.8750	1.5 .06	12.05 kg 26.58 lb							
EE217062X	158.750 6.2500	73.025 2.8750	13.5 .53	11.48 kg 25.32 lb							
EE217064	146.050 5.7500	73.025 2.8750	1.3 .05	12.91 kg 28.46 lb							

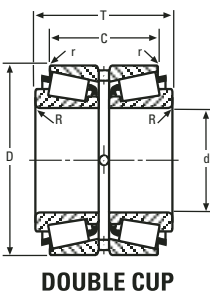
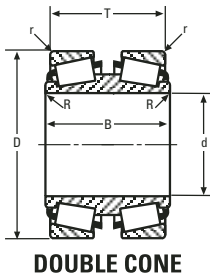
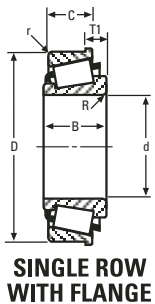
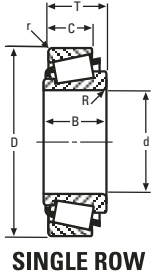

217000 SERIES CONTINUED ON NEXT PAGE

\*\*These Maximum Fillet Radii will be cleared by the Cone or Cup Radii.  
†Bore or O.D. shown are maximum dimensions. \*See Remarks Column.



CONE			Max Shaft Fillet Radii R''	Weight	CUP			Max Hs'ng Fillet Radii r''	Weight	BEARING WIDTH T	Remarks
Number	BORE d	WIDTH B			Number	OUTSIDE DIA D	WIDTH C				
<b>217000 Series (cont)</b>											
EE217063D	158.750 6.2500	125.412 4.9375	3.2 .13	28.16 kg 62.09 lb	217112	285.750 11.2500	55.562 2.1875	6.4 .25	7.36 kg 16.22 lb	128.588 5.0625	
<b>H217200 Series</b>											
†JH217249	85.000 3.3465	46.000 1.8110	3.0 .12	2.28 kg 5.03 lb	†JH217210	150.000 5.9055	38.000 1.4961	2.5 .10	1.08 kg 2.37 lb	46.000 1.8110	
<b>L217800 Series</b>											
*L217845D	85.725 3.3750	44.450 1.7500	.8 .03	1.44 kg 3.19 lb	L217810	123.825 4.8750	16.670 .6563	1.5 .06	.24 kg .52 lb	41.277 1.6251	L217845D: SHOULDER ON OD RIGHTFACE L217849DA: ASYMMETRICAL BEARING
*L217849DA	88.900 3.5000	48.420 1.9063	1.5 .06	1.36 kg 2.99 lb	*L217813-BR	127.000 5.0000	19.050 .7500	1.5 .06	.36 kg .80 lb	41.277 1.6251	L217810D : GROOVE IN OD CENTER HOLES IN OD CENTER
					L217813	127.000 5.0000	19.050 .7500	1.5 .06	.35 kg .76 lb	41.277 1.6251	L217810DC : HOLES IN OD CENTER
L217847	87.312 3.4375	20.638 .8125	1.5 .06	.54 kg 1.19 lb	L217810	123.825 4.8750	16.670 .6563	1.5 .06	.24 kg .52 lb	20.637 .8125	L217810DE : GROOVE IN OD CENTER HOLES IN OD CENTER
L217849	88.900 3.5000	20.638 .8125	1.5 .06	.51 kg 1.12 lb	*L217810DE	123.825 4.8750	53.975 2.1250	.8 .03	.81 kg 1.79 lb	61.910 2.4374	L217813-BR : GROOVE IN OD FRONTFACE
					*L217810DC	123.825 4.8750	42.862 1.6875	.8 .03	.61 kg 1.36 lb	50.797 1.9999	
					*L217810D	123.825 4.8750	42.862 1.6875	.8 .03	.61 kg 1.36 lb	50.797 1.9999	
					*L217813-BR	127.000 5.0000	19.050 .7500	1.5 .06	.36 kg .80 lb	20.637 .8125	
					L217813	127.000 5.0000	19.050 .7500	1.5 .06	.35 kg .76 lb	20.637 .8125	
<b>LL217800 Series</b>											
LL217849	88.900 3.5000	15.083 .5938	1.5 .06	.35 kg .78 lb	LL217810	121.442 4.7812	11.112 .4375	1.5 .06	.13 kg .28 lb	15.082 .5938	
<b>HM218200 Series</b>											
HM218238	79.974 3.1486	40.000 1.5748	7.0 .28	2.20 kg 4.84 lb	HM218210	146.975 5.7864	32.500 1.2795	3.5 .14	.79 kg 1.75 lb	40.000 1.5748	
HM218248	89.974 3.5423	40.000 1.5748	7.0 .28	1.77 kg 3.91 lb	HM218210P	146.975 5.7864	32.500 1.2795	3.5 .14	.79 kg 1.75 lb	40.000 1.5748	
HM218248-Z	89.974 3.5423	40.000 1.5748	7.0 .28	1.77 kg 3.91 lb	HM218215	152.400 6.0000	32.500 1.2795	3.3 .13	1.12 kg 2.47 lb	40.000 1.5748	
<b>LM218900 Series</b>											
LM218948	92.075 3.6250	29.370 1.1563	1.5 .06	- -	*LM218911	130.175 5.1250	26.988 1.0625	1.5 .06	.49 kg 1.09 lb	28.575 1.1250	LM218911 : SHOULDER ON ID FRONTFACE
<b>219000 Series</b>											
EE219065	165.100 6.5000	82.550 3.2500	6.4 .25	17.25 kg 38.03 lb	219117	298.450 11.7500	63.500 2.5000	6.4 .25	6.98 kg 15.39 lb	82.550 3.2500	
EE219068	174.625 6.8750	82.550 3.2500	6.4 .25	15.60 kg 34.40 lb	219122	311.150 12.2500	63.500 2.5000	6.4 .25	9.99 kg 22.03 lb	82.550 3.2500	
<b>220000 Series</b>											
*EE220975DW	247.650 9.7500	114.300 4.5000	1.5 .06	46.98 kg 103.60 lb	221575	400.050 15.7500	46.038 1.8125	6.4 .25	8.57 kg 18.90 lb	119.060 4.6874	EE220975DW: KEYWAY IN ID NA221027-SW: FRONTFACE CHAMFER SLOTS IN FRONTFACE
EE221025D	260.350 10.2500	114.300 4.5000	6.4 .25	42.43 kg 93.57 lb							
EE221027D	260.350 10.2500	120.650 4.7500	1.5 .06	42.97 kg 94.76 lb							EE221039TD: TAPERED BORE
EE221018	258.763 10.1875	67.470 2.6563	9.7 .38	19.24 kg 42.43 lb	*221575-B	400.050 15.7500	46.038 1.8125	6.4 .25	9.80 kg 21.62 lb	38.100 1.5000	221575-B : FLANGE ON OD FRONTFACE, BEARING WIDTH IS T1 DIMENSION
EE221026	260.350 10.2500	67.470 2.6563	9.7 .38	18.90 kg 41.68 lb	221575	400.050 15.7500	46.038 1.8125	6.4 .25	8.57 kg 18.90 lb	69.850 2.7500	221576CD : GROOVE IN OD CENTER HOLES IN OD CENTER
					*221576CD	400.050 15.7500	107.950 4.2500	1.5 .06	21.10 kg 46.52 lb	155.581 6.1252	
NA221026	260.350 10.2500	73.025 2.8750	6.4 .25	- -	*221576CD	400.050 15.7500	107.950 4.2500	1.5 .06	21.10 kg 46.52 lb	146.050 5.7500	
*NA221027-SW	260.350 10.2500	73.025 2.8750	6.4 .25	- -							
*EE221039TD	263.525 10.3750	192.088 7.5625	1.5 .06	63.56 kg 140.16 lb	EE221039TD may be paired with all single cups corresponding to EE220975DW and will require 77.788 mm (3.0625 in) to be added to the T-width values.						

\*\*These Maximum Fillet Radii will be cleared by the Cone or Cup Radii.  
†Bore or O.D. shown are maximum dimensions. \*See Remarks Column.

HM220100 – HH221400 SERIES

CONE			Max Shaft Fillet Radii R <sup>**</sup>	Weight	CUP			Max Hs'ng Fillet Radii r <sup>**</sup>	Weight	BEARING WIDTH T	Remarks
Number	BORE d	WIDTH B			Number	OUTSIDE DIA D	WIDTH C				
<b>HM220100 Series</b>											
*HM220145	99.974 3.9360	52.500 2.0669	8.0 .31	2.16 kg 4.76 lb	HM220110	156.975 6.1801	34.000 1.3386	3.5 .14	.86 kg 1.89 lb	42.000 1.6535	HM220145: EXTENDED SMALL RIB
HM220149	99.974 3.9360	42.000 1.6535	8.0 .31	1.96 kg 4.33 lb	HM220110-Z	156.975 6.1801	34.000 1.3386	3.5 .14	.89 kg 1.95 lb	42.000 1.6535	
HM220149-Z	99.974 3.9360	42.000 1.6535	8.0 .31	1.96 kg 4.33 lb							
<b>EH220700 Series</b>											
EH220749	95.250 3.7500	73.025 2.8750	3.3 .13	7.19 kg 15.85 lb	EH220710	200.025 7.8750	58.738 2.3125	3.3 .13	3.45 kg 7.61 lb	73.025 2.8750	
<b>HH221400 Series</b>											
HH221430	76.200 3.0000	57.531 2.2650	3.5 .14	6.65 kg 14.66 lb	HH221410	190.500 7.5000	46.038 1.8125	3.3 .13	2.21 kg 4.88 lb	57.150 2.2500	HH221430V: MADE FROM VACUUM MELT STEEL
*HH221430V	76.200 3.0000	57.531 2.2650	3.5 .14	6.65 kg 14.66 lb	*HH221410-B	190.500 7.5000	46.038 1.8125	3.3 .13	2.48 kg 5.46 lb	22.225 .8750	JHH221437P: EXTENDED LARGE RIB
HH221431	79.375 3.1250	57.531 2.2650	3.5 .14	6.48 kg 14.28 lb	*HH221410D	190.500 7.5000	104.775 4.1250	1.5 .06	5.28 kg 11.65 lb	127.000 5.0000	HH221449NW: SLOTS IN FRONTFACE
HH221432	87.312 3.4375	57.531 2.2650	8.0 .31	5.95 kg 13.12 lb	*HH221410DC	190.500 7.5000	104.775 4.1250	1.5 .06	5.28 kg 11.65 lb	127.000 5.0000	HH221449TD: ASYMMETRICAL BEARING REVERSE TAPERED BORE
HH221434	88.900 3.5000	57.531 2.2650	8.0 .31	5.85 kg 12.90 lb	*HH221410XX	190.500 7.5000	46.038 1.8125	3.3 .13	2.21 kg 4.88 lb	57.150 2.2500	HH221449XX: MADE FROM VACUUM MELT STEEL
†JHH221436	90.000 3.5433	57.531 2.2650	8.0 .31	5.78 kg 12.74 lb	HH221411	190.500 7.5000	46.038 1.8125	3.3 .13	2.22 kg 4.90 lb	57.150 2.2500	HH221410-B: FLANGE ON OD FRONTFACE, BEARING WIDTH IS T1 DIMENSION
HH221438	92.075 3.6250	57.531 2.2650	8.0 .31	5.64 kg 12.45 lb	†JHH221413	190.000 7.4803	46.038 1.8125	3.3 .13	2.16 kg 4.76 lb	57.150 2.2500	HH221410D: GROOVE IN OD CENTER HOLES IN OD CENTER
HH221440	95.250 3.7500	57.531 2.2650	8.0 .31	5.43 kg 11.98 lb	†JHH221414P	190.000 7.4803	48.500 1.9094	3.0 .12	2.35 kg 5.19 lb	59.544 2.3443	HH221410DC: HOLES IN OD CENTER
HH221442	98.425 3.8750	57.531 2.2650	3.5 .14	5.28 kg 11.63 lb	HH221416	200.025 7.8750	50.800 2.0000	3.3 .13	3.72 kg 8.19 lb	61.912 2.4375	HH221410XX: MADE FROM VACUUM MELT STEEL
HH221447	99.982 3.9363	57.531 2.2650	6.4 .25	5.13 kg 11.31 lb							
HH221449	101.600 4.0000	57.531 2.2650	8.0 .31	4.99 kg 10.99 lb							
HH221449A	101.600 4.0000	57.531 2.2650	3.5 .14	5.05 kg 11.14 lb							
*HH221449XX	101.600 4.0000	57.531 2.2650	8.0 .31	4.99 kg 10.99 lb							
HH221440D	95.250 3.7500	127.000 5.0000	6.4 .25	12.38 kg 27.30 lb	HH221410	190.500 7.5000	46.038 1.8125	3.3 .13	2.21 kg 4.88 lb	117.475 4.6250	
*HH221449TD	101.600 4.0000	127.000 5.0000	.8 .03	12.22 kg 26.95 lb	*HH221410XX	190.500 7.5000	46.038 1.8125	3.3 .13	2.21 kg 4.88 lb	117.475 4.6250	
					HH221411	190.500 7.5000	46.038 1.8125	3.3 .13	2.22 kg 4.90 lb	117.475 4.6250	
					†JHH221413	190.000 7.4803	46.038 1.8125	3.3 .13	2.16 kg 4.76 lb	117.475 4.6250	
					†JHH221414P	190.000 7.4803	48.500 1.9094	3.0 .12	2.35 kg 5.19 lb	122.240 4.8126	
					HH221416	200.025 7.8750	50.800 2.0000	3.3 .13	3.72 kg 8.19 lb	127.000 5.0000	
HH221449NA	101.600 4.0000	63.500 2.5000	3.5 .14	10.36 kg 22.85 lb	*HH221410D	190.500 7.5000	104.775 4.1250	1.5 .06	5.28 kg 11.65 lb	127.000 5.0000	
					*HH221410DC	190.500 7.5000	104.775 4.1250	1.5 .06	5.28 kg 11.65 lb	127.000 5.0000	
					K326068	260.350 10.2500	133.350 5.2500	3.3 .13	31.27 kg 68.95 lb	127.000 5.0000	
HH221435	89.980 3.5425	63.924 2.5167	4.0 .16	6.29 kg 13.86 lb	HH221435 may be paired with all single cups corresponding to HH221430 and will require 6.469 mm (.2547 in) to be added to the T-width values. HH221435 may be paired with all double cups corresponding to HH221430 and will require 12.939 mm (.5094 in) to be added to the T-width values.						

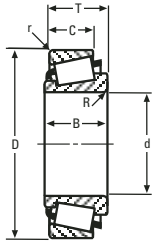

SINGLE ROW



SINGLE ROW WITH FLANGE

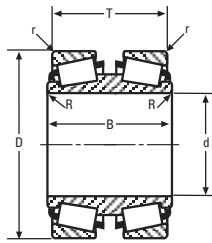

DOUBLE CONE

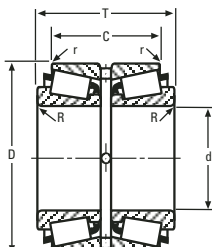

DOUBLE CUP

HH221400 – HH224300 SERIES

CONE			Max Shaft Fillet Radii R''	Weight	CUP			Max Hs'ng Fillet Radii r''	Weight	BEAR-ING	Remarks
Number	BORE d	WIDTH B			Number	OUTSIDE DIA D	WIDTH C			WIDTH T	
HH221400 Series (cont)											
*JHH221437P	90.000 3.5433	65.500 2.5787	4.0 .16	6.43 kg 14.17 lb	JHH221437P may be paired with all single cups corresponding to HH221430 and will require 7.968 mm (.3137 in) to be added to the T-width values. JHH221437P may be paired with all double cups corresponding to HH221430 and will require 15.936 mm (.6274 in) to be added to the T-width values.						
*HH221449NW	101.600 4.0000	68.262 2.6875	8.0 .31	10.65 kg 23.49 lb	*HH221410D 190.500 7.5000	104.775 4.1250	1.5 .06	5.28 kg 11.65 lb	136.652 5.3800		
					*HH221410DC 190.500 7.5000	104.775 4.1250	1.5 .06	5.28 kg 11.65 lb	136.652 5.3800		
H221600 Series											
*H221647NA	99.982 3.9363	59.926 2.3593	3.3 .13	9.11 kg 20.08 lb	K426864	224.988 8.8578	117.000 4.6063	- -	16.08 kg 35.45 lb	119.852 4.7186	H221647NA: FRONTFACE CHAMFER SHOULDER ON OD BACKFACE SLOTS IN FRONTFACE
*H221648NA	99.982 3.9363	59.926 2.3593	3.3 .13	9.11 kg 20.08 lb							H221648NA: FRONTFACE CHAMFER SHOULDER ON OD BACKFACE SLOTS IN FRONTFACE
*H221648NAV	99.982 3.9363	59.926 2.3593	3.3 .13	9.11 kg 20.08 lb							H221648NAV: FRONTFACE CHAMFER MADE FROM VACUUM MELT STEEL SHOULDER ON OD BACKFACE SLOTS IN FRONTFACE
222000 Series											
EE222070	177.800 7.0000	85.725 3.3750	3.5 .14	19.42 kg 42.82 lb	222126	319.964 12.5970	65.088 2.5625	4.8 .19	9.37 kg 20.66 lb	88.900 3.5000	222127CD: GROOVE IN OD CENTER HOLES IN OD CENTER
					*222127CD	320.675 12.6250	138.112 5.4375	1.5 .06	19.81 kg 43.68 lb	185.738 7.3125	
					222128	320.675 12.6250	65.088 2.5625	4.8 .19	9.55 kg 21.06 lb	88.900 3.5000	
EE222074D	187.325 7.3750	161.925 6.3750	3.3 .13	42.73 kg 94.23 lb	222126	319.964 12.5970	65.088 2.5625	4.8 .19	9.37 kg 20.66 lb	168.275 6.6250	
					222128	320.675 12.6250	65.088 2.5625	4.8 .19	9.55 kg 21.06 lb	168.275 6.6250	
NA222075	187.325 7.3750	92.867 3.6562	5.5 .22	- -	*222127CD	320.675 12.6250	138.112 5.4375	1.5 .06	19.81 kg 43.68 lb	185.735 7.3124	
224000 Series											
EE224115	292.100 11.5000	107.950 4.2500	6.4 .25	- -	*224199	508.000 20.0000	91.283 3.5938	6.4 .25	28.18 kg 62.14 lb	123.032 4.8438	224199: SHOULDER ON ID FRONTFACE
					224200	508.000 20.0000	74.612 2.9375	3.3 .13	24.67 kg 54.40 lb	106.362 4.1875	224205D: GROOVE IN OD CENTER HOLES IN OD CENTE
					224204	520.700 20.5000	76.200 3.0000	6.4 .25	31.29 kg 68.98 lb	107.950 4.2500	224205DC: HOLES IN OD CENTER
					*224205DC	520.700 20.5000	165.100 6.5000	1.5 .06	69.93 kg 154.19 lb	228.600 9.0000	
					*224205D	520.700 20.5000	165.100 6.5000	1.5 .06	69.93 kg 154.19 lb	228.600 9.0000	
EE224124D	314.325 12.3750	196.850 7.7500	1.3 .05	- -	*224199	508.000 20.0000	91.283 3.5938	6.4 .25	28.18 kg 62.14 lb	187.324 7.3750	
					224200	508.000 20.0000	74.612 2.9375	3.3 .13	24.67 kg 54.40 lb	187.324 7.3750	
					224204	520.700 20.5000	76.200 3.0000	6.4 .25	31.29 kg 68.98 lb	190.500 7.5000	
HH224300 Series											
HH224332	98.425 3.8750	66.675 2.6250	3.5 .14	8.85 kg 19.50 lb	HH224310	212.725 8.3750	53.975 2.1250	3.3 .13	3.03 kg 6.68 lb	66.674 2.6250	HH224335V: MADE FROM VACUUM MELT STEEL
†JHH224333	100.000 3.9370	66.675 2.6250	7.0 .28	8.67 kg 19.12 lb	*HH224310-B	212.725 8.3750	53.975 2.1250	3.3 .13	4.12 kg 9.08 lb	23.812 .9375	HH224346H: GROOVE IN OD FRONTFACE NO SMALL RIB SHOULDER ON OD FRONTFACE
HH224334	99.974 3.9360	66.675 2.6250	3.5 .14	8.72 kg 19.23 lb	*HH224310CD	212.725 8.3750	117.475 4.6250	1.5 .06	6.46 kg 14.25 lb	142.874 5.6250	HH224346V: MADE FROM VACUUM MELT STEEL
HH224335	101.600 4.0000	66.675 2.6250	7.0 .28	8.53 kg 18.82 lb	*HH224310V	212.725 8.3750	53.975 2.1250	3.3 .13	3.03 kg 6.68 lb	66.674 2.6250	HH224310-B: FLANGE ON OD FRONTFACE, BEARING WIDTH IS T1 DIMENSION

6

†These Maximum Fillet Radii will be cleared by the Cone or Cup Radii.  
†Bore or O.D. shown are maximum dimensions. \*See Remarks Column.

HH224300 – M224700 SERIES

CONE			Max Shaft Fillet Radii R <sup>**</sup>	Weight	CUP			Max Hs'ng Fillet Radii r <sup>**</sup>	Weight	BEARING WIDTH T	Remarks
Number	BORE d	WIDTH B			Number	OUTSIDE DIA D	WIDTH C				
<b>HH224300 Series</b>											
*HH224335V	101.600 4.0000	66.675 2.6250	7.0 .28	8.58 kg 18.91 lb	HH224314	214.975 8.4636	50.800 2.0000	3.3 .13	3.14 kg 6.93 lb	64.797 2.5511	HH224310CD : GROOVE IN OD CENTER HOLES IN OD CENTER  HH224310V : MADE FROM VACUUM MELT STEEL K444677 : SPECIAL RADIUS ON LEFTFACE OD SPECIAL RADIUS ON RIGHTFACE OD
HH224340	107.950 4.2500	66.675 2.6250	8.0 .31	7.97 kg 17.57 lb	†JHH224315	215.000 8.4646	53.975 2.1250	3.3 .13	3.35 kg 7.39 lb	66.674 2.6250	
HH224346	114.300 4.5000	66.675 2.6250	7.0 .28	7.41 kg 16.33 lb							
*HH224346H	114.300 4.5000	66.675 2.6250	7.0 .28	- -							
*HH224346V	114.300 4.5000	66.675 2.6250	7.0 .28	7.50 kg 16.54 lb							
HH224349	114.976 4.5266	66.675 2.6250	7.0 .28	7.34 kg 16.19 lb							
HH224346DD	114.300 4.5000	152.400 6.0000	3.3 .13	19.33 kg 42.62 lb	HH224310	212.725 8.3750	53.975 2.1250	3.3 .13	3.03 kg 6.68 lb	142.875 5.6250	
					*HH224310V	212.725 8.3750	53.975 2.1250	3.3 .13	3.03 kg 6.68 lb	142.875 5.6250	
					HH224314	214.975 8.4636	50.800 2.0000	3.3 .13	3.14 kg 6.93 lb	139.121 5.4772	
					†JHH224315	215.000 8.4646	53.975 2.1250	3.3 .13	3.35 kg 7.39 lb	142.875 5.6250	
HH224346NA	114.300 4.5000	71.438 2.8125	3.5 .14	15.17 kg 33.44 lb	K110108	311.150 12.2500	158.750 6.2500	3.3 .13	55.03 kg 121.35 lb	142.875 5.6250	
					*HH224310CD	212.725 8.3750	117.475 4.6250	1.5 .06	6.46 kg 14.25 lb	142.875 5.6250	
					*K444677	260.350 10.2500	139.700 5.5000	spcl. spcl.	26.39 kg 58.20 lb	142.875 5.6250	
<b>M224700 Series</b>											
*M224742TA	110.990 4.3697	38.892 1.5312	spcl. spcl.	2.53 kg 5.58 lb	M224710	174.625 6.8750	27.783 1.0938	1.5 .06	.86 kg 1.89 lb	35.517 1.3983	M224742TA: BROKEN FRONTFACE ID REVERSE TAPERED BORE SPECIAL BACKFACE RADIUS
*M224745TA	113.020 4.4496	38.892 1.5312	spcl. spcl.	2.42 kg 5.34 lb	M224711	172.242 6.7812	27.783 1.0938	1.5 .06	.72 kg 1.58 lb	35.517 1.3983	M224743T: REVERSE TAPERED BORE SPECIAL BACKFACE RADIUS SPECIAL FRONTFACE RADIUS
					M224712	174.625 6.8750	27.783 1.0938	3.3 .13	.86 kg 1.89 lb	35.517 1.3983	
					M224713	172.242 6.7812	27.783 1.0938	3.3 .13	.71 kg 1.57 lb	35.517 1.3983	M224745TA: BROKEN FRONTFACE ID SPECIAL BACKFACE RADIUS TAPERED BORE
					*M224713A	172.242 6.7812	27.783 1.0938	spcl. spcl.	.71 kg 1.57 lb	35.517 1.3983	
M224746D	120.134 4.7297	68.262 2.6875	.8 .03	4.24 kg 9.35 lb	M224710	174.625 6.8750	27.783 1.0938	1.5 .06	.86 kg 1.89 lb	66.678 2.6251	M224747TD: TAPERED BORE TQI/TQO (NON-INTERLOCKING)
M224749D	120.650 4.7500	68.262 2.6875	.8 .03	4.74 kg 10.45 lb	M224711	172.242 6.7812	27.783 1.0938	1.5 .06	.72 kg 1.58 lb	66.678 2.6251	M224748: SPECIAL BACKFACE RADIUS SPECIAL FRONTFACE RADIUS
					M224712	174.625 6.8750	27.783 1.0938	3.3 .13	.86 kg 1.89 lb	66.678 2.6251	M224749T: SPECIAL BACKFACE RADIUS SPECIAL FRONTFACE RADIUS TAPERED BORE
					M224713	172.242 6.7812	27.783 1.0938	3.3 .13	.71 kg 1.57 lb	66.678 2.6251	
					*M224713A	172.242 6.7812	27.783 1.0938	spcl. spcl.	.71 kg 1.57 lb	66.678 2.6251	M224710D : GROOVE IN OD CENTER HOLES IN OD CENTER
											M224710DA : HOLES IN OD CENTER M224710DC : GROOVE IN OD CENTER HOLES IN OD CENTER
											M224713A : SPECIAL RADIUS ON BACKFACE OD
											M224715DA : HOLES IN OD CENTER SPECIAL RADIUS ON LEFTFACE OD SPECIAL RADIUS ON RIGHTFACE OD SPHERICAL OD

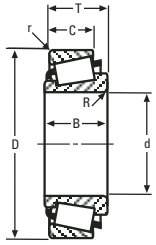

SINGLE ROW



SINGLE ROW WITH FLANGE

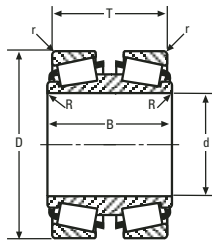

DOUBLE CONE

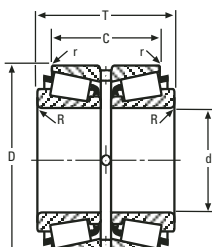

DOUBLE CUP

M224700 SERIES CONTINUED ON NEXT PAGE

\*\*These Maximum Fillet Radii will be cleared by the Cone or Cup Radii.  
†Bore or O.D. shown are maximum dimensions. \*See Remarks Column.



M224700 – HH228300 SERIES

6

CONE			Max Shaft Fillet Radii R''	Weight	CUP			Max Hs'ng Fillet Radii r''	Weight	BEAR-ING	Remarks
Number	BORE d	WIDTH B			Number	OUTSIDE DIA D	WIDTH C			WIDTH T	
<b>M224700 Series (cont)</b>											
*M224743T	113.706 4.4766	38.895 1.5313	spcl. spcl.	2.42 kg 5.33 lb	M224743T and grouped cones may be paired with all single cups corresponding to M224742TA and will require .102 mm (.0040 in) to be added to the T-width values.						
*M224749T	123.032 4.8438	38.895 1.5313	spcl.	1.90 kg 4.18 lb							
*M224747TD	119.792 4.7162	73.022 2.8749	spcl. spcl.	5.23 kg 11.54 lb	M224747TD may be paired with all single cups corresponding to M224742TA and will require -.203 mm (-.0080 in) to be added to the T-width values.						
*M224748	119.974 4.7234	36.512 1.4375	spcl. spcl.	1.87 kg 4.13 lb	M224710	174.625 6.8750	27.783 1.0938	1.5 .06	.86 kg 1.89 lb	35.720 1.4063	
M224749	120.650 4.7500	36.512 1.4375	3.5 .14	1.83 kg 4.05 lb	*M224710D	174.625 6.8750	61.912 2.4375	.8 .03	1.96 kg 4.32 lb	77.787 3.0625	
					*M224710DA	174.625 6.8750	61.912 2.4375	.8 .03	1.96 kg 4.32 lb	77.787 3.0625	
					*M224710DC	174.625 6.8750	61.912 2.4375	.8 .03	1.96 kg 4.32 lb	77.787 3.0625	
					M224711	172.242 6.7812	27.783 1.0938	1.5 .06	.72 kg 1.58 lb	35.720 1.4063	
					M224712	174.625 6.8750	27.783 1.0938	3.3 .13	.86 kg 1.89 lb	35.720 1.4063	
					M224713	172.242 6.7812	27.783 1.0938	3.3 .13	.71 kg 1.57 lb	35.720 1.4063	
					*M224713A	172.242 6.7812	27.783 1.0938	spcl. spcl.	.71 kg 1.57 lb	35.720 1.4063	
					*M224715DA	192.088 7.5625	61.912 2.4375	spcl. spcl.	4.11 kg 9.07 lb	77.787 3.0625	
<b>H225100 Series</b>											
H225148	117.475 4.6250	69.850 2.7500	8.0 .31	6.34 kg 13.97 lb	H225110	212.725 8.3750	49.212 1.9375	3.3 .13	3.06 kg 6.75 lb	63.500 2.5000	
<b>LL225700 Series</b>											
LL225749	127.000 5.0000	17.462 .6875	1.5 .06	.64 kg 1.40 lb	LL225710	165.895 6.5313	13.495 .5313	1.5 .06	.28 kg .62 lb	18.257 .7188	
<b>L225800 Series</b>											
L225842	120.650 4.7500	26.195 1.0313	1.5 .06	1.34 kg 2.96 lb	L225810	169.862 6.6875	20.638 .8125	1.5 .06	.52 kg 1.15 lb	25.400 1.0000	
L225849	127.000 5.0000	26.195 1.0313	1.5 .06	1.09 kg 2.40 lb	*L225812D	169.974 6.6919	49.212 1.9375	1.0 .04	1.24 kg 2.73 lb	58.738 2.3125	
					L225818	180.975 7.1250	20.638 .8125	1.5 .06	1.01 kg 2.23 lb	25.400 1.0000	
<b>M227400 Series</b>											
M227442	127.000 5.0000	47.625 1.8750	1.5 .06	7.48 kg 16.50 lb	M227418XD	212.725 8.3750	139.700 5.5000	1.5 .06	10.24 kg 22.58 lb	117.477 4.6251	
<b>HM227500 Series</b>											
HM227542	127.000 5.0000	60.325 2.3750	3.3 .13	5.49 kg 12.11 lb	HM227515	215.900 8.5000	44.450 1.7500	3.3 .13	2.68 kg 5.91 lb	57.150 2.2500	
HM227545	129.967 5.1168	60.325 2.3750	3.3 .13	5.21 kg 11.49 lb	HM227519	219.974 8.6604	44.450 1.7500	3.3 .13	3.17 kg 6.99 lb	57.150 2.2500	
<b>HH228300 Series</b>											
HH228336	119.974 4.7234	82.550 3.2500	4.0 .16	13.64 kg 30.08 lb	HH228310	254.000 10.0000	61.912 2.4375	6.4 .25	5.98 kg 13.20 lb	77.788 3.0625	
HH228340	120.650 4.7500	82.550 3.2500	9.7 .38	13.44 kg 29.63 lb	*HH228310V	254.000 10.0000	61.912 2.4375	6.4 .25	5.98 kg 13.20 lb	77.788 3.0625	
HH228344	123.825 4.8750	82.550 3.2500	9.7 .38	13.04 kg 28.75 lb	HH228310X	254.000 10.0000	61.912 2.4375	6.4 .25	6.06 kg 13.36 lb	77.788 3.0625	
HH228349	127.000 5.0000	82.550 3.2500	9.7 .38	12.63 kg 27.86 lb	HH228315	258.763 10.1875	61.912 2.4375	6.4 .25	6.91 kg 15.24 lb	77.788 3.0625	
HH228349H	127.000 5.0000	82.550 3.2500	9.7 .38	12.84 kg 28.32 lb	HH228318	259.974 10.2352	61.912 2.4375	4.0 .16	7.22 kg 15.92 lb	77.788 3.0625	
*HH228349V	127.000 5.0000	82.550 3.2500	9.7 .38	12.63 kg 27.86 lb							
*HH228346NW	129.974 5.1171	86.248 3.3956	3.3 .13	25.50 kg 56.23 lb	*K326078	299.974 11.8100	169.321 6.6662	spcl. spcl.	41.59 kg 91.70 lb	172.750 6.8012	

\*\*These Maximum Fillet Radii will be cleared by the Cone or Cup Radii.  
†Bore or O.D. shown are maximum dimensions. \*See Remarks Column.

HH228300 SERIES CONTINUED ON NEXT PAGE

HH228300 – 230000 SERIES

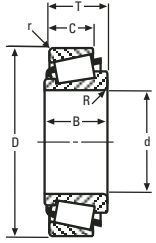

SINGLE ROW

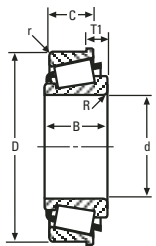

SINGLE ROW WITH FLANGE

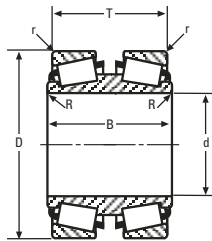

DOUBLE CONE

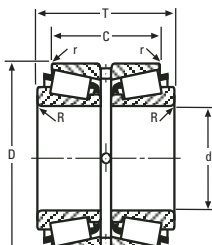

DOUBLE CUP

CONE			Max Shaft Fillet Radii R <sup>**</sup>	Weight	CUP			Max Hs'ng Fillet Radii r <sup>**</sup>	Weight	BEARING WIDTH T	Remarks
Number	BORE d	WIDTH B			Number	OUTSIDE DIA D	WIDTH C				
HH228300 Series (cont)											
*HH228346NWW	129.974 5.1171	86.248 3.3956	3.3 .13	25.74 kg 56.75 lb							HH228349NA: FRONTFACE CHAMFER SHOULDER ON OD BACKFACE SLOTS IN FRONTFACE HH228349V: MADE FROM VACUUM MELT STEEL HH228310V: MADE FROM VACUUM MELT STEEL K326078: SPECIAL RADIUS ON LEFTFACE OD SPECIAL RADIUS ON RIGHTFACE OD
*HH228347NWW	129.974 5.1171	86.248 3.3956	3.3 .13	25.25 kg 55.68 lb							
*HH228347NWW	129.974 5.1171	86.248 3.3956	3.3 .13	25.25 kg 55.68 lb							
*HH228349NA	129.974 5.1171	86.248 3.3956	3.3 .13	25.25 kg 55.68 lb	HH228349NA may be paired with all double cups corresponding to HH228346NW and will require -.254 mm (-.0100 in) to be added to the T-width values.						
H228600 Series											
*H228643DW	127.000 5.0000	120.650 4.7500	1.5 .06	18.37 kg 40.51 lb	H228610	225.425 8.8750	52.388 2.0625	3.3 .13	3.37 kg 7.42 lb	120.650 4.7500	H228643DW: KEYWAY IN ID H228649TD: TAPERED BORE
H228649D	136.525 5.3750	120.650 4.7500	1.5 .06	16.48 kg 36.34 lb							
*H228649TD	136.525 5.3750	120.650 4.7500	1.5 .06	17.49 kg 38.57 lb							
M228900 Series											
M228934NA	127.000 5.0000	45.242 1.7812	1.5 .06	- -	M228918XD	216.687 8.5310	65.088 2.5625	.8 .03	4.63 kg 10.20 lb	90.485 3.5624	
HH229000 Series											
*HH229045NWW	129.987 5.1176	80.000 3.1496	3.0 .12	23.90 kg 52.70 lb	*K312494	299.987 11.8105	157.998 6.2204	spcl. spcl.	38.46 kg 84.80 lb	160.259 6.3094	HH229045NW: FRONTFACE CHAMFER SHOULDER ON OD BACKFACE SLOTS IN FRONTFACE HH229046NWW: FRONTFACE CHAMFER MADE FROM VACUUM MELT STEEL SHOULDER ON OD BACKFACE SLOTS IN FRONTFACE HH229047NWW: FRONTFACE CHAMFER MADE FROM VACUUM MELT STEEL SHOULDER ON OD BACKFACE SLOTS IN FRONTFACE K312494: SPECIAL RADIUS ON LEFTFACE OD SPECIAL RADIUS ON RIGHTFACE OD
*HH229046NWW	129.987 5.1176	80.000 3.1496	3.0 .12	23.90 kg 52.70 lb							
*HH229047NWW	129.987 5.1176	80.000 3.1496	3.0 .12	23.35 kg 51.49 lb							
LM229100 Series											
LM229140C	136.525 5.3750	33.000 1.2992	3.5 .14	2.34 kg 5.16 lb	LM229110	194.975 7.6762	27.500 1.0827	3.5 .14	.77 kg 1.70 lb	33.000 1.2992	
LM229147C	142.875 5.6250	33.000 1.2992	3.5 .14	1.98 kg 4.37 lb							
LM229136C	133.350 5.2500	35.300 1.3898	3.5 .14	2.69 kg 5.92 lb	LM229136C may be paired with all single cups corresponding to LM229140C and will require 2.300 mm (.0906 in) to be added to the T-width values.						
M229300 Series											
M229349	146.050 5.7500	40.000 1.5748	3.5 .14	2.64 kg 5.82 lb	M229310	203.200 8.0000	38.100 1.5000	3.5 .14	1.37 kg 3.02 lb	45.100 1.7756	
M229349A	146.050 5.7500	40.000 1.5748	5.0 .20	2.63 kg 5.80 lb							
230000 Series											
EE231400	355.600 14.0000	66.675 2.6250	6.4 .25	28.76 kg 63.42 lb	231975	501.650 19.7500	50.800 2.0000	3.3 .13	10.68 kg 23.55 lb	74.612 2.9375	EE231401DG: GROOVE IN ID 231976CD: GROOVE IN OD CENTER HOLES IN OD CENTER
EE231462	371.475 14.6250	66.675 2.6250	6.4 .25	24.03 kg 52.98 lb	*231976CD	501.650 19.7500	107.950 4.2500	1.5 .06	21.91 kg 48.31 lb	155.575 6.1250	232000-B: FLANGE ON OD FRONTFACE BEARING WIDTH IS T1 DIMENSION
					*232000-B	508.000 20.0000	50.800 2.0000	3.3 .13	13.68 kg 30.17 lb	38.100 1.5000	
					232025	514.350 20.2500	50.800 2.0000	3.3 .13	14.70 kg 32.42 lb	74.612 2.9375	232026D: GROOVE IN OD CENTER HOLES IN OD CENTER

230000 SERIES CONTINUED ON NEXT PAGE

\*\*These Maximum Fillet Radii will be cleared by the Cone or Cup Radii.  
†Bore or O.D. shown are maximum dimensions. \*See Remarks Column.

6

CONE			Max Shaft Fillet Radii R''	Weight	CUP			Max Hs'ng Fillet Radii r''	Weight	BEARING WIDTH T	Remarks
Number	BORE d	WIDTH B			Number	OUTSIDE DIA D	WIDTH C				
<b>230000 Series (cont)</b>											
					<b>*232026D</b>	514.350 20.2500	107.950 4.2500	1.5 .06	32.60 kg 71.88 lb	155.575 6.1250	
<b>NA231400</b>	355.600 14.0000	73.025 2.8750	6.4 .25	- -	<b>*231976CD</b>	501.650 19.7500	107.950 4.2500	1.5 .06	21.91 kg 48.31 lb	146.050 5.7500	
					<b>*232026D</b>	514.350 20.2500	107.950 4.2500	1.5 .06	32.60 kg 71.88 lb	146.050 5.7500	
<b>EE231401D</b>	355.600 14.0000	111.125 4.3750	3.3 .13	60.50 kg 133.40 lb	<b>231975</b>	501.650 19.7500	50.800 2.0000	3.3 .13	10.68 kg 23.55 lb	127.000 5.0000	
<b>*EE231401DG</b>	355.600 14.0000	111.125 4.3750	3.3 .13	60.44 kg 133.28 lb	<b>232025</b>	514.350 20.2500	50.800 2.0000	3.3 .13	14.70 kg 32.42 lb	127.000 5.0000	
<b>EE231475D</b>	374.650 14.7500	117.475 4.6250	1.5 .06	52.05 kg 114.77 lb							
<b>H230800 Series</b>											
<b>H230844</b>	139.700 5.5000	68.262 2.6875	14.3 .56	8.14 kg 17.96 lb	<b>H230811</b>	241.300 9.5000	50.800 2.0000	3.3 .13	3.70 kg 8.16 lb	63.500 2.5000	
<b>H230847</b>	144.462 5.6875	68.262 2.6875	3.3 .13	7.69 kg 16.96 lb	<b>H230818</b>	247.650 9.7500	50.800 2.0000	3.3 .13	4.61 kg 10.17 lb	63.500 2.5000	
					<b>H230822XD</b>	260.350 10.2500	171.450 6.7500	1.5 .06	21.04 kg 46.40 lb	142.874 5.6250	
<b>HM231100 Series</b>											
<b>*DT528T</b>	147.848 5.8208	130.970 5.1563	3.0 .12	16.22 kg 35.76 lb	<b>HM231110</b>	236.538 9.3125	44.450 1.7500	3.3 .13	2.80 kg 6.17 lb	112.446 4.4270	DT528T: GROOVE IN OD CENTER INVERTED BEARING NO SMALL RIB TAPERED BORE
					<b>HM231115</b>	241.300 9.5000	44.450 1.7500	3.3 .13	3.42 kg 7.54 lb	112.446 4.4270	
<b>HM231132</b>	139.700 5.5000	56.642 2.2300	3.5 .14	7.36 kg 16.24 lb	<b>HM231110</b>	236.538 9.3125	44.450 1.7500	3.3 .13	2.80 kg 6.17 lb	57.150 2.2500	HM231111CD : GROOVE IN OD CENTER HOLES IN OD CENTER
<b>HM231133</b>	139.700 5.5000	60.325 2.3750	3.5 .14	7.25 kg 16.00 lb	<b>*HM231111CD</b>	236.538 9.3125	106.362 4.1875	1.5 .06	6.77 kg 14.93 lb	131.762 5.1875	HM231115-B : FLANGE ON OD FRONTFACE, BEARING WIDTH IS T1 DIMENSION
<b>HM231136</b>	142.875 5.6250	56.642 2.2300	3.5 .14	7.05 kg 15.55 lb	<b>*HM231115-B</b>	241.300 9.5000	44.450 1.7500	3.3 .13	3.63 kg 8.01 lb	22.225 .8750	HM231116D : GROOVE IN OD CENTER HOLES IN OD CENTER
<b>HM231140</b>	146.050 5.7500	56.642 2.2300	3.5 .14	6.73 kg 14.84 lb	<b>HM231115</b>	241.300 9.5000	44.450 1.7500	3.3 .13	3.42 kg 7.54 lb	57.150 2.2500	HM231116DC : HOLES IN OD CENTER
<b>HM231148</b>	149.225 5.8750	56.642 2.2300	6.4 .25	6.35 kg 14.01 lb	<b>*HM231116DC</b>	241.300 9.5000	106.362 4.1875	1.5 .06	8.34 kg 18.39 lb	131.762 5.1875	
<b>HM231149</b>	149.225 5.8750	56.642 2.2300	3.5 .14	6.41 kg 14.12 lb	<b>*HM231116D</b>	241.300 9.5000	106.362 4.1875	1.5 .06	8.34 kg 18.39 lb	131.762 5.1875	
<b>HM231140NA</b>	146.050 5.7500	65.883 2.5938	3.5 .14	- -	<b>*HM231111CD</b>	236.538 9.3125	106.362 4.1875	1.5 .06	6.77 kg 14.93 lb	131.765 5.1876	
<b>HM231149NA</b>	149.225 5.8750	65.883 2.5938	3.5 .14	- -	<b>*HM231116DC</b>	241.300 9.5000	106.362 4.1875	1.5 .06	8.34 kg 18.39 lb	131.765 5.1876	
					<b>*HM231116D</b>	241.300 9.5000	106.362 4.1875	1.5 .06	8.34 kg 18.39 lb	131.765 5.1876	
<b>HH231600 Series</b>											
<b>HH231637</b>	127.000 5.0000	87.312 3.4375	13.5 .53	18.99 kg 41.88 lb	<b>HH231610</b>	288.925 11.3750	57.150 2.2500	6.4 .25	6.99 kg 15.41 lb	82.550 3.2500	
<b>HH231649</b>	139.700 5.5000	87.312 3.4375	9.7 .38	17.31 kg 38.17 lb	<b>HH231615</b>	295.275 11.6250	57.150 2.2500	6.4 .25	8.80 kg 19.41 lb	82.550 3.2500	
<b>HH231637D</b>	127.000 5.0000	158.750 6.2500	13.2 .52	42.85 kg 94.49 lb	<b>HH231610</b>	288.925 11.3750	57.150 2.2500	6.4 .25	6.99 kg 15.41 lb	149.226 5.8750	
					<b>HH231615</b>	295.275 11.6250	57.150 2.2500	6.4 .25	8.80 kg 19.41 lb	149.226 5.8750	
<b>M231600 Series</b>											
<b>†JM231646</b>	150.000 5.9055	46.830 1.8437	3.5 .14	4.15 kg 9.15 lb	<b>M231610</b>	222.250 8.7500	34.925 1.3750	1.5 .06	1.86 kg 4.11 lb	46.830 1.8437	M231642TA: REVERSE TAPERED BORE
<b>M231648</b>	152.400 6.0000	46.830 1.8437	8.0 .31	3.84 kg 8.46 lb	<b>*M231610CD</b>	222.250 8.7500	76.200 3.0000	.8 .03	3.91 kg 8.62 lb	100.010 3.9374	M231645TA: TAPERED BORE
<b>M231649</b>	152.400 6.0000	46.830 1.8437	3.5 .14	3.93 kg 8.67 lb	<b>*M231610DA</b>	222.250 8.7500	76.200 3.0000	.8 .03	4.05 kg 8.92 lb	100.010 3.9374	M231647: EXTENDED SMALL RIB FRONTFACE CHAMFER
<b>M231649A</b>	152.400 6.0000	46.830 1.8437	3.5 .14	4.09 kg 9.02 lb	<b>*M231610V</b>	222.250 8.7500	34.925 1.3750	1.5 .06	1.86 kg 4.11 lb	46.830 1.8437	M231647D: SHOULDER ON OD RIGHTFACE

†These Maximum Fillet Radii will be cleared by the Cone or Cup Radii.  
†Bore or O.D. shown are maximum dimensions. \*See Remarks Column.

M231600 – 234000 SERIES

CONE			Max Shaft Fillet Radii R <sup>**</sup>	Weight	CUP			Max Hs'ng Fillet Radii r <sup>**</sup>	Weight	BEARING	Remarks
Number	BORE d	WIDTH B			Number	OUTSIDE DIA D	WIDTH C			WIDTH T	
<b>M231600 Series (cont)</b>											
*M231649V	152.400 6.0000	46.830 1.8437	3.5 .14	3.93 kg 8.67 lb	*M231611D 222.250 8.7500	82.550 3.2500	.8 .03	4.40 kg 9.70 lb	106.360 4.1874	M231649D: SHOULDER ON OD RIGHTFACE	
					*M231611DC 222.250 8.7500	82.550 3.2500	.8 .03	4.40 kg 9.70 lb	106.360 4.1874	M231649DGW: GROOVE IN ID SHOULDER ON OD RIGHTFACE	
					†JM231613 225.000 8.8583	34.925 1.3750	1.5 .06	2.13 kg 4.70 lb	46.830 1.8437	SLOTS IN LEFTFACE	
					*M231614DC 225.425 8.8750	76.200 3.0000	.8 .03	4.05 kg 8.92 lb	100.010 3.9374	M231649TD: REVERSE TAPERED BORE	
					*M231615DA 242.888 9.5625	76.200 3.0000	spcl. spcl.	7.80 kg 17.20 lb	100.010 3.9374	M231649V: MADE FROM VACUUM MELT STEEL	
					*M231616XD 229.873 9.0501	116.000 4.5669	1.3 .05	7.56 kg 16.67 lb	108.069 4.2547	M231610CD: GROOVE IN OD CENTER HOLES IN OD CENTER	
					*M231618DB 241.300 9.5000	143.675 5.6565	spcl. spcl.	13.29 kg 29.31 lb	97.650 3.8445	M231610DA: HOLES IN OD CENTER M231610V: MADE FROM VACUUM MELT STEEL	
*M231647	150.967 5.9436	54.762 2.1560	3.5 .14	4.36 kg 9.61 lb	M231610 222.250 8.7500	34.925 1.3750	1.5 .06	1.86 kg 4.11 lb	46.830 1.8437	M231611D: GROOVE IN OD CENTER HOLES IN OD CENTER	
					*M231610V 222.250 8.7500	34.925 1.3750	1.5 .06	1.86 kg 4.11 lb	46.830 1.8437		
					†JM231613 225.000 8.8583	34.925 1.3750	1.5 .06	2.13 kg 4.70 lb	46.830 1.8437	M231611DC: HOLES IN OD CENTER	
										M231614DC: HOLES IN OD CENTER	
*M231647D	149.974 5.9045	84.138 3.3125	1.5 .06	9.44 kg 20.81 lb	M231610 222.250 8.7500	34.925 1.3750	1.5 .06	1.86 kg 4.11 lb	84.138 3.3125	M231615DA: HOLES IN OD CENTER SPECIAL RADIUS ON LEFTFACE OD	
*M231649D	152.400 6.0000	84.138 3.3125	1.5 .06	9.06 kg 19.97 lb	*M231610V 222.250 8.7500	34.925 1.3750	1.5 .06	1.86 kg 4.11 lb	84.138 3.3125	SPECIAL RADIUS ON RIGHTFACE OD	
*M231649DGW	152.400 6.0000	84.138 3.3125	1.5 .06	9.01 kg 19.86 lb	†JM231613 225.000 8.8583	34.925 1.3750	1.5 .06	2.13 kg 4.70 lb	84.138 3.3125	M231616XD: SPECIAL CHAMFER ON LEFTFACE OD SPECIAL CHAMFER ON RIGHTFACE OD	
*M231649TD	152.400 6.0000	84.138 3.3125	1.5 .06	9.61 kg 21.18 lb						M231618DB: ASYMMETRICAL BEARING FLANGE ON OD RIGHTFACE HOLES IN OD CENTER SPECIAL RADIUS ON LEFTFACE OD SPECIAL RADIUS ON RIGHTFACE OD	
*M231642TA	140.297 5.5235	50.005 1.9687	3.5 .14	5.34 kg 11.78 lb	M231610 222.250 8.7500	34.925 1.3750	1.5 .06	1.86 kg 4.11 lb	46.766 1.8412		
*M231645TA	144.480 5.6882	50.005 1.9687	3.5 .14	4.98 kg 10.99 lb	*M231610V 222.250 8.7500	34.925 1.3750	1.5 .06	1.86 kg 4.11 lb	46.766 1.8412		
					*M231611D 222.250 8.7500	82.550 3.2500	.8 .03	4.40 kg 9.70 lb	106.233 4.1824		
					*M231611DC 222.250 8.7500	82.550 3.2500	.8 .03	4.40 kg 9.70 lb	106.233 4.1824		
					†JM231613 225.000 8.8583	34.925 1.3750	1.5 .06	2.13 kg 4.70 lb	46.766 1.8412		
					*M231616XD 229.873 9.0501	116.000 4.5669	1.3 .05	7.56 kg 16.67 lb	107.942 4.2497		
<b>H232200 Series</b>											
H232240	139.700 5.5000	74.612 2.9375	3.3 .13	22.46 kg 49.53 lb	*H232214YD 261.925 10.3120	149.225 5.8750	1.5 .06	15.54 kg 34.26 lb	177.800 7.0000	H232214YD: HOLES IN OD CENTER	
H232249	152.400 6.0000	74.612 2.9375	3.3 .13	19.06 kg 42.02 lb							
<b>234000 Series</b>											
EE234154	393.700 15.5000	61.120 2.4063	6.4 .25	28.08 kg 61.92 lb	*234213CD 539.750 21.2500	101.600 4.0000	1.5 .06	24.64 kg 54.34 lb	142.875 5.6250	EE234156W: KEYWAY IN BACKFACE	
EE234156	396.875 15.6250	61.120 2.4063	6.4 .25	27.14 kg 59.84 lb	234215 546.100 21.5000	55.562 2.1875	6.4 .25	16.92 kg 37.30 lb	76.200 3.0000	EE234160W: KEYWAY IN BACKFACE	
*EE234156W	396.875 15.6250	61.120 2.4063	6.4 .25	27.78 kg 61.26 lb	*234215W 546.100 21.5000	55.562 2.1875	6.4 .25	17.32 kg 38.19 lb	76.200 3.0000	234213CD: GROOVE IN OD CENTER HOLES IN OD CENTER	
EE234160	406.400 16.0000	61.120 2.4063	6.4 .25	24.26 kg 53.49 lb	*234216D 546.100 21.5000	117.475 4.6250	1.5 .06	34.29 kg 75.60 lb	158.750 6.2500	234215W: KEYWAY BACKFACE	

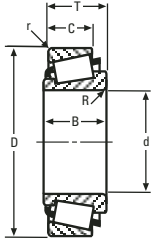

SINGLE ROW

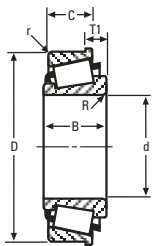

SINGLE ROW WITH FLANGE

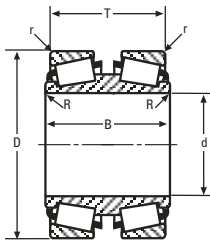

DOUBLE CONE

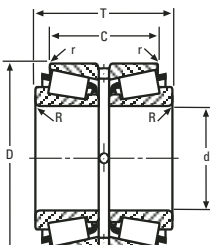

DOUBLE CUP

6

234000 – HM235100 SERIES

6

CONE			Max Shaft Fillet Radii R''	Weight	CUP			Max Hs'ng Fillet Radii r''	Weight	BEARING WIDTH T	Remarks
Number	BORE d	WIDTH B			Number	OUTSIDE DIA D	WIDTH C				
<b>234000 Series (cont)</b>											
*EE234160W	406.400 16.0000	61.120 2.4063	6.4 .25	24.94 kg 54.99 lb	*234216DC	546.100	117.475	1.5	34.29 kg	158.750	234216D : GROOVE IN OD CENTER HOLES IN OD CENTER 234216DC : HOLES IN OD CENTER 234221D : GROOVE IN OD CENTER HOLES IN OD CENTER 234221DC : HOLES IN OD CENTER
						21.5000	4.6250	.06	75.60 lb	6.2500	
					234220	558.800	44.450	6.4	16.34 kg	65.087	
						22.0000	1.7500	.25	36.03 lb	2.5625	
					*234221D	558.800	104.775	1.5	39.81 kg	146.050	
	22.0000	4.1250	.06	87.78 lb	5.7500						
					*234221DC	558.800	104.775	1.5	39.81 kg	146.050	
						22.0000	4.1250	.06	87.78 lb	5.7500	
EE234157D	393.700	120.650	3.3	72.76 kg	234215	546.100	55.562	6.4	16.92 kg	141.288	
	15.5000	4.7500	.13	160.44 lb		21.5000	2.1875	.25	37.30 lb	5.5625	
EE234161D	406.400	120.650	1.5	65.21 kg	*234215W	546.100	55.562	6.4	17.32 kg	141.288	
	16.0000	4.7500	.06	143.79 lb		21.5000	2.1875	.25	38.19 lb	5.5625	
					234220	558.800	44.450	6.4	16.34 kg	119.062	
						22.0000	1.7500	.25	36.03 lb	4.6875	
<b>HH234000 Series</b>											
HH234031	139.700	93.662	9.7	22.66 kg	HH234010	307.975	66.675	6.8	8.62 kg	88.900	HH234048V: MADE FROM VACUUM MELT STEEL
	5.5000	3.6875	.38	49.97 lb		12.1250	2.6250	.27	19.02 lb	3.5000	HH234010V: MADE FROM VACUUM MELT STEEL
HH234032	139.700	93.662	9.7	-	*HH234010V	307.975	66.675	6.8	8.62 kg	88.900	
	5.5000	3.6875	.38	-		12.1250	2.6250	.27	19.02 lb	3.5000	HH234011CD: GROOVE IN OD CENTER HOLES IN OD CENTER
HH234040	146.050	93.662	9.7	-	*HH234011CD	307.975	155.575	2.3	20.37 kg	200.024	
	5.7500	3.6875	.38	-		12.1250	6.1250	.09	44.93 lb	7.8750	
HH234048	152.400	93.662	9.7	20.51 kg	HH234018	317.500	66.675	6.8	11.05 kg	88.900	
	6.0000	3.6875	.38	45.23 lb		12.5000	2.6250	.27	24.36 lb	3.5000	
*HH234048V	152.400	93.662	9.7	20.51 kg							
	6.0000	3.6875	.38	45.23 lb							
HH234049	152.400	93.662	9.7	-							
	6.0000	3.6875	.38	-							
HH234032D	139.700	171.450	13.5	-	HH234010	307.975	66.675	6.8	8.62 kg	161.925	
	5.5000	6.7500	.53	-		12.1250	2.6250	.27	19.02 lb	6.3750	
HH234049D	152.400	171.450	9.7	-	*HH234010V	307.975	66.675	6.8	8.62 kg	161.925	
	6.0000	6.7500	.38	-		12.1250	2.6250	.27	19.02 lb	6.3750	
					HH234018	317.500	66.675	6.8	11.05 kg	161.925	
						12.5000	2.6250	.27	24.36 lb	6.3750	
<b>H234600 Series</b>											
H234646TD	163.512	146.050	1.5	29.65 kg	H234610	269.875	61.912	3.3	5.68 kg	146.050	H234646TD: TAPERED BORE
	6.4375	5.7500	.06	65.39 lb		10.6250	2.4375	.13	12.51 lb	5.7500	H234647TD: KEYWAY IN ID TAPERED BORE
*H234647TD	163.512	146.050	1.5	29.65 kg							
	6.4375	5.7500	.06	65.39 lb							
*H234649TD	165.100	146.050	1.5	29.56 kg							H234649TD: TAPERED BORE
	6.5000	5.7500	.06	65.18 lb							
<b>HM234600 Series</b>											
HM234636	152.400	71.438	6.4	11.34 kg	HM234610	266.700	50.800	3.3	4.17 kg	66.675	
	6.0000	2.8125	.25	25.01 lb		10.5000	2.0000	.13	9.20 lb	2.6250	
HM234643	159.512	71.438	1.5	10.40 kg	HM234612	266.700	50.800	3.3	4.22 kg	66.675	
	6.2800	2.8125	.06	22.92 lb		10.5000	2.0000	.13	9.30 lb	2.6250	
HM234648	165.100	71.438	1.5	9.67 kg							
	6.5000	2.8125	.06	21.33 lb							
HM234648DD	165.100	158.750	1.5	25.10 kg	HM234610	266.700	50.800	3.3	4.17 kg	149.224	
	6.5000	6.2500	.06	55.34 lb		10.5000	2.0000	.13	9.20 lb	5.8750	
					HM234612	266.700	50.800	3.3	4.22 kg	149.224	
						10.5000	2.0000	.13	9.30 lb	5.8750	
<b>H235100 Series</b>											
H235148	165.100	84.138	3.3	26.02 kg	*H235118YD	290.500	165.100	1.5	23.52 kg	200.026	H235118YD : HOLES IN OD CENTER
	6.5000	3.3125	.13	57.37 lb		11.4370	6.5000	.06	51.87 lb	7.8750	
<b>HM235100 Series</b>											
*HM235145TA	168.521	59.533	3.5	7.30 kg	HM235118	260.350	41.275	3.3	3.51 kg	53.900	HM235145TA: REVERSE TAPERED BORE
	6.6347	2.3438	.14	16.09 lb		10.2500	1.6250	.13	7.74 lb	2.1220	HM235149TA: TAPERED BORE
*HM235149TA	173.497	59.533	3.5	6.68 kg							HM235110DA : HOLES IN OD CENTER
	6.8306	2.3438	.14	14.74 lb							

\*\*These Maximum Fillet Radii will be cleared by the Cone or Cup Radii.  
†Bore or O.D. shown are maximum dimensions. \*See Remarks Column.

HM235100 – M236800 SERIES

CONE			Max Shaft Fillet Radii R <sup>**</sup>	Weight	CUP			Max Hs'ng Fillet Radii r <sup>**</sup>	Weight	BEARING	Remarks
Number	BORE d	WIDTH B			Number	OUTSIDE DIA D	WIDTH C			WIDTH T	
<b>HM235100 Series (cont)</b>											
HM235148	165.100	58.738	1.5	7.31 kg 16.12 lb	*HM235110DA	254.000	93.662	.8	6.23 kg	119.062	HM235115DA : HOLES IN OD CENTER SPECIAL RADIUS ON LEFT FACE OD SPECIAL RADIUS ON RIGHTFACE OD SPHERICAL OD
	6.5000	2.3125	.06		*HM235115DA	278.608	93.662	1.5	12.70 kg	119.062	
					HM235118	260.350	41.275	3.3	3.51 kg	53.975	
<b>M235100 Series</b>											
M235145	165.100	46.038	4.8	5.67 kg 12.50 lb	*M235110DA	250.825	76.200	.8	4.78 kg 10.54 lb	101.600	M235137TA : REVERSE TAPERED BORE
	6.5000	1.8125	.19			9.8750	3.0000	.03		4.0000	M235140TA : TAPERED BORE
M235146	168.275	46.038	4.8	5.41 kg 11.93 lb	M235113	254.000	33.338	3.3	2.24 kg 4.94 lb	46.037	M235146AX : EXTENDED LARGE RIB EXTENDED SMALL RIB SHOULDER ON OD BACKFACE
	6.6250	1.8125	.19			10.0000	1.3125	.13		1.8125	
M235149	170.000	46.038	4.8	5.20 kg 11.47 lb	*M235113CD	254.000	76.200	1.5	4.99 kg 11.00 lb	101.600	M235146X : EXTENDED LARGE RIB EXTENDED SMALL RIB SHOULDER ON OD BACKFACE
	6.6929	1.8125	.19			10.0000	3.0000	.06		4.0000	
					M235114XD	254.000	76.200	1.5	-	101.600	M235146X : EXTENDED LARGE RIB EXTENDED SMALL RIB SHOULDER ON OD BACKFACE
						10.0000	3.0000	.06		4.0000	
					*M235115DA	269.875	76.200	1.6	8.76 kg 19.32 lb	101.600	
						10.6250	3.0000	.06		4.0000	M235110DA : HOLES IN OD CENTER M235113CD : GROOVE IN OD CENTER HOLES IN OD CENTER
*M235137TA	154.079	50.990	3.7	7.17 kg 15.80 lb	M235113	254.000	33.338	3.3	2.24 kg 4.94 lb	45.974	M235115DA : HOLES IN OD CENTER SPHERICAL OD
	6.0661	2.0075	.15			10.0000	1.3125	.13		1.8100	
*M235140TA	158.328	50.990	3.4	6.76 kg 14.90 lb							
	6.2334	2.0075	.13								
*M235146AX	167.945	53.975	4.8	5.88 kg 12.96 lb	M235146AX and grouped cones may be paired with all single cups corresponding to M235137TA and will require 3.238 mm (.1275 in) to be added to the T-width values.						
*M235146X	168.326	53.975	4.8	5.83 kg 12.87 lb							
	6.6270	2.1250	.19								
<b>LM236700 Series</b>											
LM236749	184.150	33.000	2.0	2.39 kg 5.27 lb	LM236710	234.950	28.000	2.0	.98 kg 2.16 lb	34.000	
	7.2500	1.2992	.08			9.2500	1.1024	.08		1.3386	
					LM236710A	235.229	28.000	2.0	1.00 kg 2.21 lb	34.000	
						9.2610	1.1024	.08		1.3386	
<b>M236700 Series</b>											
*M236745TD	174.308	133.350	1.6	19.69 kg 43.41 lb	M236712	260.502	33.338	3.3	2.13 kg 4.69 lb	133.350	M236745TD : TAPERED BORE
	6.8625	5.2500	.06			10.2560	1.3125	.13		5.2500	
<b>M236800 Series</b>											
*M236841DH	170.190	130.000	3.5	-	M236810	260.350	41.275	3.3	2.82 kg 6.22 lb	98.425	M236841DH : INVERTED BEARING
	6.7004	5.1181	.14			10.2500	1.6250	.13		3.8750	
					*M236810V	260.350	41.275	3.3	2.82 kg 6.22 lb	98.425	M236845V : MADE FROM VACUUM MELT STEEL
						10.2500	1.6250	.13		3.8750	
					M236817	259.951	41.275	3.3	2.79 kg 6.15 lb	98.425	M236810V : MADE FROM VACUUM MELT STEEL
						10.2343	1.6250	.13		3.8750	
M236845	174.625	53.975	3.5	6.60 kg 14.56 lb	M236810	260.350	41.275	3.3	2.82 kg 6.22 lb	53.975	
	6.8750	2.1250	.14			10.2500	1.6250	.13		2.1250	
*M236845V	174.625	53.975	3.5	6.60 kg 14.55 lb	*M236810V	260.350	41.275	3.3	2.82 kg 6.22 lb	53.975	
	6.8750	2.1250	.14			10.2500	1.6250	.13		2.1250	
M236848	177.800	53.975	8.0	6.12 kg 13.50 lb	M236817	259.951	41.275	3.3	2.79 kg 6.15 lb	53.975	
	7.0000	2.1250	.31			10.2343	1.6250	.13		2.1250	
M236849	177.800	53.975	3.5	6.23 kg 13.74 lb							
	7.0000	2.1250	.14								
M236849H	177.800	53.975	3.5	6.15 kg 13.55 lb							
	7.0000	2.1250	.14								

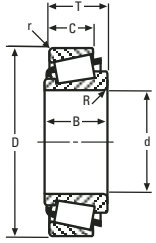

SINGLE ROW

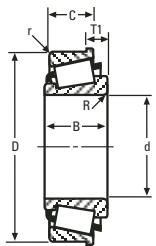

SINGLE ROW WITH FLANGE

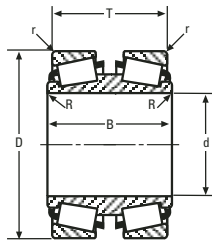

DOUBLE CONE

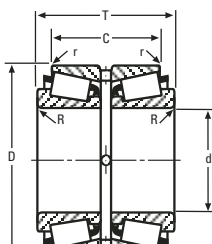

DOUBLE CUP

HM237500 – M238800 SERIES

6

CONE			Max Shaft Fillet Radii R''	Weight	CUP			Max Hs'ng Fillet Radii r''	Weight	BEARING WIDTH T	Remarks
Number	BORE d	WIDTH B			Number	OUTSIDE DIA D	WIDTH C				
<b>HM237500 Series</b>											
HM237532	160.325 6.3120	63.500 2.5000	7.0 .28	13.36 kg 29.47 lb	HM237510	288.925 11.3750	47.625 1.8750	3.3 .13	4.46 kg 9.84 lb	63.500 2.5000	HM237536: FRONTFACE CHAMFER
HM237534	165.100 6.5000	68.262 2.6875	3.3 .13	12.65 kg 27.90 lb	HM237510A	279.964 11.0222	47.625 1.8750	3.3 .13	3.04 kg 6.70 lb	63.500 2.5000	HM237545D: ASYMMETRICAL BEARING SHOULDER ON OD LEFTFACE
HM237535	165.100 6.5000	63.500 2.5000	7.0 .28	12.75 kg 28.12 lb	*HM237510-B	288.925 11.3750	47.625 1.8750	3.3 .13	4.96 kg 10.94 lb	26.988 1.0625	HM237546: EXTENDED SMALL RIB
*HM237536	165.100 6.5000	63.500 2.5000	7.0 .28	12.74 kg 28.09 lb	*HM237510CD	288.925 11.3750	111.125 4.3750	1.5 .06	10.33 kg 22.78 lb	142.875 5.6250	HM237549TD: TAPERED BORE
HM237537	164.976 6.4951	68.000 2.6772	7.0 .28	12.59 kg 27.76 lb	HM237511	288.925 11.3750	47.625 1.8750	3.3 .13	4.52 kg 9.96 lb	63.500 2.5000	HM237510-B : FLANGE ON OD FRONTFACE, BEARING WIDTH IS T1 DIMENSION
HM237540	171.450 6.7500	63.500 2.5000	7.0 .28	11.92 kg 26.28 lb	HM237511XD	288.925 11.3750	114.300 4.5000	1.5 .06	11.75 kg 25.90 lb	146.050 5.7500	HM237510CD : GROOVE IN OD CENTER HOLES IN OD CENTER
HM237542	174.625 6.8750	63.500 2.5000	7.0 .28	11.49 kg 25.33 lb	HM237513	289.974 11.4163	48.000 1.8898	3.0 .12	4.67 kg 10.29 lb	63.500 2.5000	
HM237542H	174.625 6.8750	63.500 2.5000	7.0 .28	11.71 kg 25.82 lb							
HM237543	177.800 7.0000	68.262 2.6875	3.3 .13	10.82 kg 23.87 lb							
HM237545	177.800 7.0000	63.500 2.5000	7.0 .28	11.05 kg 24.36 lb							
HM237547	180.000 7.0866	68.262 2.6875	7.0 .28	10.40 kg 22.94 lb							
HM237542D	174.625 6.8750	123.825 4.8750	1.5 .06	25.88 kg 57.06 lb	HM237510	288.925 11.3750	47.625 1.8750	3.3 .13	4.46 kg 9.84 lb	123.825 4.8750	
*HM237545D	177.800 7.0000	127.000 5.0000	1.5 .06	25.19 kg 55.54 lb	HM237510A	279.964 11.0222	47.625 1.8750	3.3 .13	3.04 kg 6.70 lb	123.825 4.8750	
HM237546D	177.800 7.0000	123.825 4.8750	1.5 .06	25.06 kg 55.25 lb	HM237511	288.925 11.3750	47.625 1.8750	3.3 .13	4.52 kg 9.96 lb	123.825 4.8750	
					HM237513	289.974 11.4163	48.000 1.8898	3.0 .12	4.67 kg 10.29 lb	123.825 4.8750	
HM237536NA	165.100 6.5000	71.438 2.8125	3.5 .14	26.97 kg 59.46 lb	*HM237510CD	288.925 11.3750	111.125 4.3750	1.5 .06	10.33 kg 22.78 lb	142.875 5.6250	
HM237545NA	177.800 7.0000	71.438 2.8125	5.5 .22	23.05 kg 50.82 lb	HM237511XD	288.925 11.3750	114.300 4.5000	1.5 .06	11.75 kg 25.90 lb	142.875 5.6250	
*HM237546	179.954 7.0848	70.000 2.7559	3.3 .13	10.54 kg 23.24 lb	HM237546 may be paired with all single cups corresponding to HM237532 and will require -1.438 mm (-.0566 in) to be added to the T-width values. HM237546 may be paired with all double cups corresponding to HM237532 and will require -2.875 mm (-.1132 in) to be added to the T-width values.						
HM237546DD	177.800 7.0000	158.750 6.2500	1.5 .06	29.00 kg 63.95 lb	HM237546DD and grouped cones may be paired with all single cups corresponding to HM237542D and will require 34.925 mm (1.3750 in) to be added to the T-width values.						
*HM237549TD	180.975 7.1250	158.750 6.2500	1.6 .06	-							
<b>H238100 Series</b>											
H238140	165.100 6.5000	82.550 3.2500	6.4 .25	19.81 kg 43.68 lb	H238110	311.150 12.2500	65.088 2.5625	6.4 .25	8.52 kg 18.79 lb	82.550 3.2500	H238147: EXTENDED SMALL RIB
*H238147	177.800 7.0000	85.725 3.3750	6.4 .25	16.17 kg 35.67 lb	*H238116YD	319.075 12.5620	187.325 7.3750	1.5 .06	32.49 kg 71.65 lb	222.250 8.7500	H238116YD : HOLES IN OD CENTER
H238148	174.625 6.8750	82.550 3.2500	6.4 .25	18.16 kg 40.05 lb							
<b>M238800 Series</b>											
M238840	177.800 7.0000	55.562 2.1875	3.5 .14	7.95 kg 17.52 lb	M238810	269.875 10.6250	42.862 1.6875	3.3 .13	3.12 kg 6.87 lb	55.563 2.1875	M238831T: REVERSE TAPERED BORE
tJM238848	190.000 7.4803	55.562 2.1875	3.0 .12	6.47 kg 14.27 lb	*M238810-B	269.875 10.6250	42.862 1.6875	3.3 .13	3.30 kg 7.28 lb	22.225 .8750	M238832T: REVERSE TAPERED BORE
M238849	187.325 7.3750	55.562 2.1875	3.5 .14	6.76 kg 14.90 lb	*M238810CD	269.875 10.6250	93.662 3.6875	1.5 .06	6.73 kg 14.84 lb	119.063 4.6875	M238845TD: TAPERED BORE TQI/TQO (NON-INTERLOCKING)
					*M238810D	269.875 10.6250	93.662 3.6875	1.5 .06	7.19 kg 15.85 lb	119.063 4.6875	M238848TE: EXTENDED LARGE RIB TAPERED BORE
					*M238810DC	269.875 10.6250	93.662 3.6875	1.5 .06	7.19 kg 15.85 lb	119.063 4.6875	M238849D: SHOULDER ON OD LEFTFACE

\*\*These Maximum Fillet Radii will be cleared by the Cone or Cup Radii.  
†Bore or O.D. shown are maximum dimensions. \*See Remarks Column.

M238800 – M239400 SERIES

CONE			Max Shaft Fillet Radii R <sup>**</sup>	Weight	CUP			Max Hs'ng Fillet Radii r <sup>**</sup>	Weight	BEARING		Remarks
Number	BORE d	WIDTH B			Number	OUTSIDE DIA D	WIDTH C			WIDTH T		
<b>M238800 Series (cont)</b>												
*M238849D	187.325 7.3750	101.600 4.0000	1.5 .06	15.62 kg 34.43 lb	M238810	269.875 10.6250	42.862 1.6875	3.3 .13	3.12 kg 6.87 lb	101.600 4.0000	M238849DW: SHOULDER ON OD LEFTFACE SLOTS IN RIGHTFACE	
*M238849DW	187.325 7.3750	101.600 4.0000	1.5 .06	15.62 kg 34.43 lb							M238849TDE: EXTENDED SMALL RIB TAPERED BORE	
*M238849TDE	187.325 7.3750	160.338 6.3125	1.6 .06	20.55 kg 45.31 lb							M238810-B : FLANGE ON OD FRONTFACE, BEARING WIDTH IS T1 DIMENSION M238810CD : GROOVE IN OD CENTER HOLES IN OD CENTER M238810D : GROOVE IN OD CENTER HOLES IN OD CENTER M238810DC : HOLES IN OD CENTER	
*M238831T	177.140 6.9740	59.533 2.3438	3.4 .14	8.63 kg 19.03 lb	M238810	269.875 10.6250	42.862 1.6875	3.3 .13	3.12 kg 6.87 lb	55.283 2.1765		
					*M238810-B	269.875 10.6250	42.862 1.6875	3.3 .13	3.30 kg 7.28 lb	21.946 .8640		
*M238832T	175.153 6.8958	55.562 2.1875	3.5 .14	8.76 kg 19.32 lb	M238832T may be paired with all single cups corresponding to M238840 and will require -.279 mm (-.0110 in) to be added to the T-width values. M238832T may be paired with all double cups corresponding to M238840 and will require -.559 mm (-.0220 in) to be added to the T-width values.							
*M238845TD	185.870 7.3177	128.585 5.0624	1.6 .06	18.94 kg 41.76 lb	M238845TD may be paired with all single cups corresponding to M238849D and will require -.559 mm (-.0220 in) to be added to the T-width values.							
*M238848TE	193.807 7.6302	95.250 3.7500	1.5 .06	10.26 kg 22.63 lb	M238848TE may be paired with all single cups corresponding to M238840 and will require 39.408 mm (1.5515 in) to be added to the T-width values. M238848TE may be paired with all double cups corresponding to M238840 and will require 78.816 mm (3.1030 in) to be added to the T-width values.							
<b>239000 Series</b>												
EE239170	431.800 17.0000	73.025 2.8750	3.3 .13	- -	239225A	571.500 22.5000	57.150 2.2500	3.3 .13	15.98 kg 35.23 lb	76.200 3.0000	EE239171D: HOLES IN OD CENTER	
					239225	571.500 22.5000	53.975 2.1250	3.3 .13	14.83 kg 32.71 lb	73.025 2.8750	EE239172DW: ASYMMETRICAL BEARING SHOULDER ON OD RIGHTFACE SLOTS IN LEFTFACE	
					*239225D	571.500 22.5000	120.650 4.7500	1.5 .06	33.90 kg 74.76 lb	158.750 6.2500	239225D : GROOVE IN OD CENTER HOLES IN OD CENTER	
					239226XD	571.500 22.5000	120.650 4.7500	1.5 .06	31.27 kg 68.96 lb	158.750 6.2500		
					239227	571.500 22.5000	55.562 2.1875	3.3 .13	15.42 kg 34.00 lb	74.613 2.9375		
					239228XD	571.500 22.5000	117.475 4.6250	1.5 .06	30.49 kg 67.22 lb	155.575 6.1250		
*EE239171D	431.800 17.0000	130.175 5.1250	1.5 .06	74.69 kg 164.69 lb	239225A	571.500 22.5000	57.150 2.2500	3.3 .13	15.98 kg 35.23 lb	139.700 5.5000		
*EE239172DW	431.800 17.0000	133.350 5.2500	1.5 .06	75.63 kg 166.77 lb	239225	571.500 22.5000	53.975 2.1250	3.3 .13	14.83 kg 32.71 lb	133.350 5.2500		
EE239173D	431.800 17.0000	130.175 5.1250	1.5 .06	74.69 kg 164.69 lb	239227	571.500 22.5000	55.562 2.1875	3.3 .13	15.42 kg 34.00 lb	136.525 5.3750		
<b>EH239300 Series</b>												
*EH239348NA	179.984 7.0860	111.915 4.4061	3.3 .13	- -	*K107552	406.400 16.0000	220.665 8.6876	spcl. spcl.	95.97 kg 211.61 lb	223.830 8.8122	EH239348NA: GROOVE IN OD FRONTFACE SHOULDER ON OD BACKFACE SLOTS IN FRONTFACE K107552 : SPECIAL RADIUS ON LEFTFACE OD SPECIAL RADIUS ON RIGHTFACE OD	
<b>M239400 Series</b>												
M239441	187.630 7.3870	57.150 2.2500	3.3 .13	7.99 kg 17.61 lb	M239410	279.400 11.0000	41.275 1.6250	3.3 .13	3.11 kg 6.86 lb	52.387 2.0625	M239448A: EXTENDED LARGE RIB SHOULDER ON OD BACKFACE	
M239447	189.738 7.4700	57.150 2.2500	3.3 .13	7.69 kg 16.95 lb	*M239410W	279.400 11.0000	41.275 1.6250	3.3 .13	3.11 kg 6.85 lb	52.387 2.0625	M239410W : KEYWAY IN OD BACKFACE	
M239449	190.475 7.4990	57.150 2.2500	3.3 .13	7.61 kg 16.78 lb								
*M239448A	191.237 7.5290	58.738 2.3125	3.3 .13	7.85 kg 17.30 lb	M239448A may be paired with all single cups corresponding to M239441 and will require 1.588 mm (.0625 in) to be added to the T-width values.							

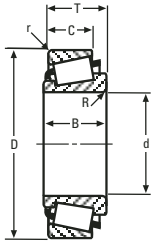

SINGLE ROW

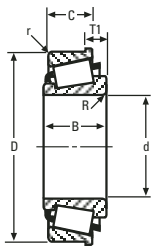

SINGLE ROW WITH FLANGE

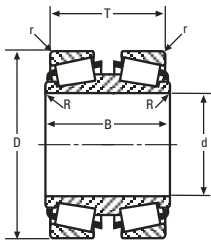

DOUBLE CONE

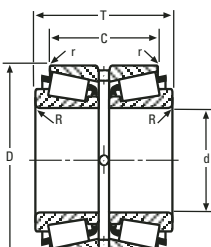

DOUBLE CUP

EH239500 SERIES CONTINUED ON NEXT PAGE

\*\*These Maximum Fillet Radii will be cleared by the Cone or Cup Radii.  
†Bore or O.D. shown are maximum dimensions. \*See Remarks Column.



**EH239500 – LM241100 SERIES**

**6**

CONE			Max Shaft Fillet Radii R <sup>**</sup>	Weight	CUP			Max Hs'ng Fillet Radii r <sup>**</sup>	Weight	BEAR-ING	Remarks
Number	BORE d	WIDTH B			Number	OUTSIDE DIA D	WIDTH C			WIDTH T	
<b>EH239500 Series</b>											
*EH239546NA	179.984 7.0860	111.915 4.4061	3.3 .13	60.71 kg 133.87 lb	*K107552 406.400 16.0000	220.665 8.6876	spcl. spcl.	95.97 kg 211.61 lb	223.830 8.8122	EH239546NA: FRONTFACE CHAMFER SHOULDER ON OD BACKFACE SLOTS IN FRONTFACE	
*EH239547NAH	179.984 7.0860	111.915 4.4061	3.3 .13	60.83 kg 134.14 lb	*K151586 406.400 16.0000	220.665 8.6876	spcl. spcl.	96.59 kg 212.97 lb	223.830 8.8122	EH239547NAH: FRONTFACE CHAMFER GROOVE IN OD FRONTFACE MADE FROM SPECIAL STEEL SHOULDER ON OD BACKFACE SLOTS IN FRONTFACE	
*EH239549NA	179.984 7.0860	111.915 4.4061	3.3 .13	60.83 kg 134.14 lb						EH239549NA: FRONTFACE CHAMFER GROOVE IN OD FRONTFACE SHOULDER ON OD BACKFACE SLOTS IN FRONTFACE	
										K107552 : SPECIAL RADIUS ON LEFTFACE OD SPECIAL RADIUS ON RIGHTFACE OD	
										K151586 : SPECIAL RADIUS ON LEFTFACE OD SPECIAL RADIUS ON RIGHTFACE OD	
<b>H239600 Series</b>											
H239640	177.800 7.0000	85.725 3.3750	3.5 .14	20.45 kg 45.09 lb	H239610 319.964 12.5970	65.088 2.5625	4.8 .19	7.93 kg 17.48 lb	88.900 3.5000	H239612CD : GROOVE IN OD CENTER HOLES IN OD CENTER	
H239649	187.325 7.3750	85.725 3.3750	5.5 .22	18.57 kg 40.95 lb	H239612 320.675 12.6250	65.088 2.5625	4.8 .19	8.11 kg 17.88 lb	88.900 3.5000		
H239649A	187.325 7.3750	85.725 3.3750	5.5 .22	18.57 kg 40.95 lb	*H239612CD 320.675 12.6250	138.112 5.4375	1.5 .06	16.84 kg 37.13 lb	185.738 7.3125		
H239649D	187.325 7.3750	161.925 6.3750	3.3 .13	44.24 kg 97.56 lb	H239610 319.964 12.5970	65.088 2.5625	4.8 .19	7.93 kg 17.48 lb	168.275 6.6250		
					H239612 320.675 12.6250	65.088 2.5625	4.8 .19	8.11 kg 17.88 lb	168.275 6.6250		
H239649NA	187.325 7.3750	92.867 3.6562	5.5 .22	- -	*H239612CD 320.675 12.6250	138.112 5.4375	1.5 .06	16.84 kg 37.13 lb	185.735 7.3124		
<b>240000 Series</b>											
EE241693	430.212 16.9375	73.025 2.8750	6.4 .25	38.63 kg 85.17 lb	242375 603.250 23.7500	50.800 2.0000	6.4 .25	20.56 kg 45.33 lb	76.200 3.0000	242376D : HOLES IN OD CENTER	
EE241701	431.800 17.0000	73.025 2.8750	6.4 .25	38.01 kg 83.82 lb	*242376D 603.250 23.7500	98.425 3.8750	1.5 .06	39.91 kg 88.00 lb	153.289 6.0350	242377CD : GROOVE IN OD CENTER HOLES IN OD CENTER	
					*242377CD 603.250 23.7500	104.775 4.1250	1.5 .06	42.29 kg 93.24 lb	159.639 6.2850		
<b>M240600 Series</b>											
*M240629T	185.938 7.3204	61.120 2.4063	3.3 .13	9.80 kg 21.61 lb	M240611 284.162 11.1875	46.038 1.8125	3.3 .13	3.60 kg 7.93 lb	56.104 2.2088	M240629T: REVERSE TAPERED BORE	
*M240631T	185.938 7.3204	61.120 2.4063	3.3 .13	9.74 kg 21.47 lb						M240631T: REVERSE TAPERED BORE	
*M240647T	200.820 7.9063	61.120 2.4063	3.0 .12	7.60 kg 16.77 lb						M240644TD: TAPERED BORE TQI/TQO (NON-INTERLOCKING)	
*M240648T	200.820 7.9063	61.120 2.4063	3.0 .12	7.66 kg 16.89 lb						M240645TD: TAPERED BORE	
*M240644TD	195.727 7.7058	117.475 4.6250	1.5 .06	10.94 kg 24.12 lb	M240611 284.162 11.1875	46.038 1.8125	3.3 .13	3.60 kg 7.93 lb	107.442 4.2300	M240647T: TAPERED BORE	
*M240645TD	195.727 7.7058	117.475 4.6250	1.5 .06	20.48 kg 45.17 lb						M240648T: TAPERED BORE	
M240648D	198.438 7.8125	107.950 4.2500	1.6 .06	17.86 kg 39.37 lb	M240648D may be paired with all single cups corresponding to M240629T and will require .508 mm (.0200 in) to be added to the T-width values.						
<b>LM241100 Series</b>											
LM241147	200.025 7.8750	46.038 1.8125	3.5 .14	5.65 kg 12.46 lb	LM241110 276.225 10.8750	34.133 1.3438	3.3 .13	2.10 kg 4.62 lb	42.863 1.6875	LM241149NW: EXTENDED LARGE RIB FRONTFACE CHAMFER SLOTS IN FRONTFACE	
LM241148	203.987 8.0310	46.038 1.8125	3.5 .14	5.20 kg 11.46 lb	LM241111 276.225 10.8750	34.133 1.3438	3.3 .13	2.15 kg 4.73 lb	42.863 1.6875	LM241110D : GROOVE IN OD CENTER HOLES IN OD CENTER	

\*\*These Maximum Fillet Radii will be cleared by the Cone or Cup Radii.  
†Bore or O.D. shown are maximum dimensions. \*See Remarks Column.

LM241100 – H242600 SERIES

CONE			Max Shaft Fillet Radii R <sup>**</sup>	Weight	CUP			Max Hs'ng Fillet Radii r <sup>**</sup>	Weight	BEAR-ING	Remarks
Number	BORE d	WIDTH B			Number	OUTSIDE DIA D	WIDTH C			WIDTH T	
<b>LM241100 Series (cont)</b>											
LM241149	203.200 8.0000	42.862 1.6875	3.5 .14	4.94 kg 10.89 lb	LM241110	276.225 10.8750	34.133 1.3438	3.3 .13	2.10 kg 4.62 lb	42.863 1.6875	LM241110DC : HOLES IN OD CENTER
					*LM241110DC	276.225 10.8750	73.025 2.8750	.8 .03	4.64 kg 10.23 lb	90.485 3.5624	
					*LM241110D	276.225 10.8750	73.025 2.8750	.8 .03	4.64 kg 10.23 lb	90.485 3.5624	
					LM241111	276.225 10.8750	34.133 1.3438	3.3 .13	2.15 kg 4.73 lb	42.863 1.6875	
*LM241149NW	203.200 8.0000	47.625 1.8750	3.5 .14	5.35 kg 11.81 lb	LM241149NW may be paired with all single cups corresponding to LM241147 and will require 2.319 mm (.0913 in) to be added to the T-width values.						
<b>M241500 Series</b>											
M241542	200.025 7.8750	61.912 2.4375	6.4 .25	8.63 kg 19.03 lb	M241510	292.100 11.5000	46.038 1.8125	3.3 .13	3.86 kg 8.52 lb	57.945 2.2813	M241530T: REVERSE TAPERED BORE
M241543	200.025 7.8750	57.945 2.2813	3.5 .14	8.64 kg 19.05 lb	*M241510CD	292.100 11.5000	101.600 4.0000	1.5 .06	8.32 kg 18.34 lb	125.415 4.9376	M241544TA: REVERSE TAPERED BORE
M241545	200.812 7.9060	61.912 2.4375	6.4 .25	8.51 kg 18.76 lb	*M241510DA	292.100 11.5000	101.600 4.0000	.8 .03	9.14 kg 20.16 lb	125.415 4.9376	M241546TD: TAPERED BORE TQI/TQO (NON-INTERLOCKING)
M241547	203.200 8.0000	57.945 2.2813	3.5 .14	8.18 kg 18.04 lb	*M241510V	292.100 11.5000	46.038 1.8125	3.3 .13	3.86 kg 8.52 lb	57.945 2.2813	M241547TA: TAPERED BORE
M241547A	203.200 8.0000	57.945 2.2813	9.7 .38	8.13 kg 17.93 lb	*M241513D	301.625 11.8750	140.005 5.5120	.8 .03	14.26 kg 31.44 lb	125.453 4.9391	M241547V: MADE FROM VACUUM MELT STEEL
M241547C	203.200 8.0000	57.945 2.2813	3.5 .14	8.18 kg 18.04 lb	M241513XD	301.625 11.8750	140.005 5.5120	.8 .03	14.93 kg 32.92 lb	125.453 4.9391	M241549TE: EXTENDED LARGE RIB SPECIAL BACKFACE RADIUS TAPERED BORE
*M241547V	203.200 8.0000	57.945 2.2813	3.5 .14	39.42 kg 86.93 lb	*M241515DA	319.075 12.5620	101.600 4.0000	spcl. spcl.	17.04 kg 37.58 lb	125.415 4.9376	M241510CD : GROOVE IN OD CENTER HOLES IN OD CENTER
M241549	204.788 8.0625	57.945 2.2813	3.5 .14	7.95 kg 17.53 lb							
*M241546TD	201.877 7.9479	119.065 4.6876	1.5 .06	22.09 kg 48.71 lb	M241510	292.100 11.5000	46.038 1.8125	3.3 .13	3.86 kg 8.52 lb	107.239 4.2220	M241510DA : HOLES IN OD CENTER
					*M241510V	292.100 11.5000	46.038 1.8125	3.3 .13	3.86 kg 8.52 lb	107.239 4.2220	M241510V : MADE FROM VACUUM MELT STEEL M241513D : GROOVE IN OD CENTER HOLES IN OD CENTER M241515DA : HOLES IN OD CENTER SPECIAL RADIUS ON LEFTFACE OD SPECIAL RADIUS ON RIGHTFACE OD
*M241530T	191.953 7.5572	63.500 2.5000	3.0 .12	10.77 kg 23.74 lb	M241530T may be paired with all single cups corresponding to M241546TD and will require -.356 mm (-.0140 in) to be added to the T-width values.						
M241538D	190.000 7.4803	107.950 4.2500	1.5 .06	23.13 kg 51.00 lb	M241538D may be paired with all single cups corresponding to M241546TD and will require .711 mm (.0280 in) to be added to the T-width values.						
*M241544TA	195.964 7.7151	62.708 2.4688	6.4 .25	10.12 kg 22.30 lb	M241544TA and grouped cones may be paired with all single cups corresponding to M241546TD and will require -.064 mm (-.0025 in) to be added to the T-width values.						
*M241547TA	201.204 7.9214	62.708 2.4688	6.4 .25	9.32 kg 20.55 lb							
*M241549TE	210.541 8.2890	103.980 4.0937	13.0 .51	12.58 kg 27.74 lb	M241549TE may be paired with all single cups corresponding to M241546TD and will require 40.124 mm (1.5797 in) to be added to the T-width values.						
<b>H242600 Series</b>											
*H242648TD	206.375 8.1250	184.150 7.2500	3.0 .12	- -	H242610	336.550 13.2500	77.788 3.0625	3.3 .13	10.95 kg 24.15 lb	180.975 7.1250	H242648TD: KEYWAY IN ID TAPERED BORE
H242649D	206.375 8.1250	184.150 7.2500	1.5 .06	52.68 kg 116.17 lb	*H242610XX	336.550 13.2500	77.788 3.0625	3.3 .13	10.95 kg 24.15 lb	180.975 7.1250	H242649TD: TAPERED BORE
*H242649TD	206.375 8.1250	184.150 7.2500	1.6 .06	38.61 kg 85.13 lb	H242649TDE: EXTENDED SMALL RIB TAPERED BORE						
*H242649TDE	208.890 8.2240	244.475 9.6250	1.5 .06	64.46 kg 142.14 lb	H242649XX: MADE FROM VACUUM MELT STEEL						

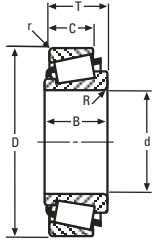

SINGLE ROW



SINGLE ROW WITH FLANGE

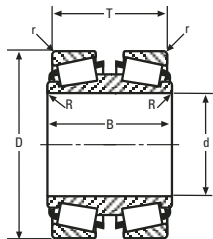

DOUBLE CONE

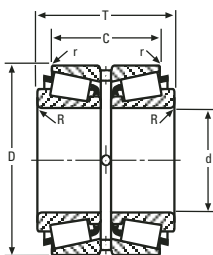

DOUBLE CUP

H242600 SERIES CONTINUED ON NEXT PAGE

\*\*These Maximum Fillet Radii will be cleared by the Cone or Cup Radii.  
†Bore or O.D. shown are maximum dimensions. \*See Remarks Column.

H242600 – M244200 SERIES

CONE			Max Shaft Fillet Radii R''	Weight	CUP			Max Hs'ng Fillet Radii r''	Weight	BEARING WIDTH T	Remarks
Number	BORE d	WIDTH B			Number	OUTSIDE DIA D	WIDTH C				
<b>H242600 Series (cont)</b>											
H242649	206.375 8.1250	100.012 3.9375	3.3 .13	22.33 kg 49.23 lb	H242610	336.550 13.2500	77.788 3.0625	3.3 .13	10.95 kg 24.15 lb	98.425 3.8750	H242610CD : GROOVE IN OD CENTER HOLES IN OD CENTER
*H242649XX	206.375 8.1250	100.012 3.9375	3.3 .13	22.33 kg 49.23 lb	*H242610CD	336.550 13.2500	169.862 6.6875	1.5 .06	24.28 kg 53.54 lb	211.138 8.3125	H242610XX : MADE FROM VACUUM MELT STEEL
					*H242610XX	336.550 13.2500	77.788 3.0625	3.3 .13	10.95 kg 24.15 lb	98.425 3.8750	
<b>243000 Series</b>											
EE243190	482.600 19.0000	80.962 3.1875	6.4 .25	46.84 kg 103.28 lb	243250	634.873 24.9950	63.500 2.5000	3.3 .13	19.05 kg 42.00 lb	80.963 3.1875	EE243192W: KEYWAY IN BACKFACE EE243196W: KEYWAY IN BACKFACE
EE243192	489.026 19.2530	80.962 3.1875	6.4 .25	43.73 kg 96.43 lb	*243250-B	634.873 24.9950	63.500 2.5000	3.3 .13	21.49 kg 47.38 lb	31.750 1.2500	243250-B : FLANGE ON OD FRONTFACE, BEARING WIDTH IS T1 DIMENSION
*EE243192W	489.026 19.2530	80.962 3.1875	6.4 .25	21.15 kg 46.63 lb	*243250W	634.873 24.9950	63.500 2.5000	3.3 .13	19.89 kg 43.85 lb	80.963 3.1875	243250W : KEYWAY BACKFACE
EE243195	498.475 19.6250	80.962 3.1875	6.4 .25	- -	*243251CD	634.873 24.9950	142.875 5.6250	1.5 .06	42.28 kg 93.22 lb	177.800 7.0000	243251CD : GROOVE IN OD CENTER HOLES IN OD CENTER
EE243196	498.475 19.6250	80.962 3.1875	6.4 .25	39.09 kg 86.19 lb	*243251D	634.873 24.9950	142.875 5.6250	1.5 .06	47.40 kg 104.52 lb	177.800 7.0000	
*EE243196W	498.475 19.6250	80.962 3.1875	6.4 .25	- -	*243251DC	634.873 24.9950	142.875 5.6250	1.5 .06	47.68 kg 105.13 lb	177.800 7.0000	243251D : GROOVE IN OD CENTER HOLES IN OD CENTER
EE243197	498.323 19.6190	80.962 3.1875	6.4 .25	39.16 kg 86.35 lb							243251DC : HOLES IN OD CENTER
EE243198	498.323 19.6190	80.962 3.1875	6.4 .25	- -							
EE243193D	489.026 19.2530	152.400 6.0000	3.3 .13	106.79 kg 235.47 lb	243250	634.873 24.9950	63.500 2.5000	3.3 .13	19.05 kg 42.00 lb	152.400 6.0000	
					*243250W	634.873 24.9950	63.500 2.5000	3.3 .13	19.89 kg 43.85 lb	152.400 6.0000	
<b>244000 Series</b>											
EE244180	457.200 18.0000	73.025 2.8750	9.7 .38	33.99 kg 74.94 lb	244235	596.900 23.5000	53.975 2.1250	3.3 .13	15.51 kg 34.21 lb	76.200 3.0000	244236CD : GROOVE IN OD CENTER HOLES IN OD CENTER
EE244180A	457.200 18.0000	73.025 2.8750	9.7 .38	33.99 kg 74.94 lb	*244236CD	596.900 23.5000	120.650 4.7500	1.5 .06	34.91 kg 76.98 lb	165.100 6.5000	
EE244181D	457.200 18.0000	130.175 5.1250	1.5 .06	77.31 kg 170.46 lb	244235	596.900 23.5000	53.975 2.1250	3.3 .13	15.51 kg 34.21 lb	133.350 5.2500	
<b>M244200 Series</b>											
*M244230T	209.616 8.2526	65.883 2.5938	3.3 .13	13.04 kg 28.75 lb	M244210	314.325 12.3750	49.212 1.9375	3.3 .13	4.68 kg 10.32 lb	61.557 2.4235	M244230T: REVERSE TAPERED BORE
*M244249T	225.425 8.8750	65.883 2.5938	3.3 .13	10.20 kg 22.50 lb	*M244210-B	314.325 12.3750	49.212 1.9375	3.3 .13	5.05 kg 11.14 lb	21.869 .8610	M244230TL: EXTENDED SMALL RIB KEYWAY IN FRONTFACE REVERSE TAPERED BORE SHOULDER ON ID FRONTFACE
					*M244210XX	314.325 12.3750	49.212 1.9375	3.3 .13	4.68 kg 10.32 lb	61.557 2.4235	M244246TD: TAPERED BORE
*M244246TD	219.936 8.6589	123.822 4.8749	1.5 .06	26.53 kg 58.49 lb	M244210	314.325 12.3750	49.212 1.9375	3.3 .13	4.68 kg 10.32 lb	115.888 4.5625	M244247TD: TAPERED BORE
M244249D	220.662 8.6875	115.888 4.5625	1.5 .06	23.92 kg 52.74 lb	*M244210XX	314.325 12.3750	49.212 1.9375	3.3 .13	4.68 kg 10.32 lb	115.888 4.5625	M244247TDL: TAPERED BORE TQI/TQO (INTERLOCKING)
*M244249DGW	220.662 8.6875	115.888 4.5625	1.5 .06	23.91 kg 52.73 lb							M244249DGW: GROOVE IN ID
M244249DW	220.662 8.6875	115.888 4.5625	1.5 .06	23.87 kg 52.63 lb							M244249DXX: MADE FROM VACUUM MELT STEEL
*M244249DXX	220.662 8.6875	115.888 4.5625	1.5 .06	23.98 kg 52.87 lb							M244249T: TAPERED BORE
*M244249TDE	222.184 8.7474	177.800 7.0000	1.5 .06	30.48 kg 67.22 lb							M244249TDE: ASYMMETRICAL BEARING EXTENDED SMALL RIB TAPERED BORE
											M244249TL: EXTENDED SMALL RIB KEYWAY IN FRONTFACE SHOULDER ON ID FRONTFACE TAPERED BORE

6

\*\*These Maximum Fillet Radii will be cleared by the Cone or Cup Radii.  
†Bore or O.D. shown are maximum dimensions. \*See Remarks Column.

M244200 – LM245100 SERIES

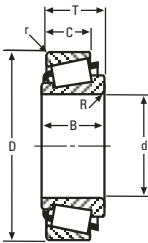
CONE			Max Shaft Fillet Radii R <sup>**</sup>	Weight	CUP			Max Hs'ng Fillet Radii r <sup>**</sup>	Weight	BEARING WIDTH T	Remarks
Number	BORE d	WIDTH B			Number	OUTSIDE DIA D	WIDTH C				
<b>M244200 Series (cont)</b>											
 <p><b>SINGLE ROW</b></p>											
*M244230TL	209.154 8.2344	60.325 2.3750	3.3 .13	9.78 kg 21.57 lb	M244210	314.325 12.3750	49.212 1.9375	3.3 .13	4.68 kg 10.32 lb	61.557 2.4235	M244210-B : FLANGE ON OD FRONTFACE, BEARING WIDTH IS T1 DIMENSION
					*M244210-B	314.325 12.3750	49.212 1.9375	3.3 .13	5.05 kg 11.14 lb	21.869 .8610	M244210CD : GROOVE IN OD CENTER HOLES IN OD CENTER
					*M244210CD	314.325 12.3750	106.362 4.1875	1.5 .06	11.22 kg 24.75 lb	131.051 5.1595	M244210DXX : GROOVE IN OD CENTER HOLES IN OD CENTER MADE FROM VACUUM MELT STEEL
					*M244210DXX	314.325 12.3750	106.362 4.1875	1.5 .06	10.08 kg 22.23 lb	131.051 5.1595	M244210XX : MADE FROM VACUUM MELT STEEL
					*M244210XX	314.325 12.3750	49.212 1.9375	3.3 .13	4.68 kg 10.32 lb	61.557 2.4235	
*M244247TD	219.936 8.6589	123.822 4.8749	1.5 .06	26.53 kg 58.49 lb	M244247TD and grouped cones may be paired with all single cups corresponding to M244246TD and will require -.711 mm (-.0280 in) to be added to the T-width values.						
*M244247TDL	220.398 8.6771	134.938 5.3125	.0 .00	27.11 kg 59.78 lb							
M244249	220.662 8.6875	61.912 2.4375	6.4 .25	9.99 kg 22.03 lb	M244249 and grouped cones may be paired with all single cups corresponding to M244230TL and will require .356 mm (.0140 in) to be added to the T-width values.						
*M244249TL	225.425 8.8750	60.325 2.3750	3.3 .13	12.37 kg 27.27 lb	M244249 and grouped cones may be paired with all double cups corresponding to M244230TL and will require .711 mm (.0280 in) to be added to the T-width values.						
M244249A	220.662 8.6875	66.675 2.6250	1.5 .06	10.37 kg 22.86 lb	M244249A may be paired with all single cups corresponding to M244230T and will require .356 mm (.0140 in) to be added to the T-width values.						
M244249NA	220.662 8.6875	65.883 2.5938	6.4 .25	20.51 kg 45.23 lb	*M244210CD	314.325 12.3750	106.362 4.1875	1.5 .06	11.22 kg 24.75 lb	131.765 5.1876	
					*M244210DXX	314.325 12.3750	106.362 4.1875	1.5 .06	10.08 kg 22.23 lb	131.765 5.1876	
<b>LL244500 Series</b>											
LL244549	231.775 9.1250	21.500 .8465	2.0 .08	1.28 kg 2.83 lb	LL244510	268.288 10.5625	18.500 .7283	2.0 .08	.57 kg 1.26 lb	22.500 .8858	LL244549VC : MADE FROM VACUUM MELT STEEL
*LL244549VC	231.775 9.1250	21.500 .8465	2.0 .08	1.28 kg 2.83 lb	*LL244510V	268.288 10.5625	18.500 .7283	1.3 .05	.59 kg 1.30 lb	22.500 .8858	LL244510V : MADE FROM VACUUM MELT STEEL
<b>M244600 Series</b>											
M244649D	219.075 8.6250	127.000 5.0000	1.5 .06	32.43 kg 71.51 lb	M244610	336.550 13.2500	47.625 1.8750	3.3 .13	5.44 kg 11.99 lb	127.000 5.0000	
<b>H244800 Series</b>											
*H244848TD	219.075 8.6250	200.025 7.8750	1.5 .06	71.86 kg 158.44 lb	H244810	358.775 14.1250	85.725 3.3750	6.4 .25	13.78 kg 30.38 lb	196.850 7.7500	H244848TD: TAPERED BORE
H244849D	219.075 8.6250	200.025 7.8750	1.5 .06	68.08 kg 150.11 lb	H244810XX	358.775 14.1250	85.725 3.3750	6.4 .25	13.78 kg 30.38 lb	196.850 7.7500	H244849TD: KEYWAY IN ID TAPERED BORE
*H244849TD	219.075 8.6250	200.025 7.8750	1.5 .06	76.50 kg 168.68 lb							
<b>LM245100 Series</b>											
*LM245130T	215.369 8.4791	53.975 2.1250	3.3 .13	9.89 kg 21.81 lb	LM245110	311.150 12.2500	38.100 1.5000	3.3 .13	2.92 kg 6.43 lb	48.959 1.9275	LM245130T: REVERSE TAPERED BORE
*LM245149T	228.600 9.0000	53.975 2.1250	3.3 .13	7.96 kg 17.55 lb							LM245146TD: TAPERED BORE TQ/TQ0 (NON-INTERLOCKING)

LM245100 SERIES CONTINUED ON NEXT PAGE

\*\*These Maximum Fillet Radii will be cleared by the Cone or Cup Radii.  
†Bore or O.D. shown are maximum dimensions. \*See Remarks Column.

LM245100 – LM247700 SERIES

6

CONE			Max Shaft Fillet Radii R <sup>**</sup>	Weight	CUP			Max Hs'ng Fillet Radii r <sup>**</sup>	Weight	BEAR-ING	Remarks
Number	BORE d	WIDTH B			Number	OUTSIDE DIA D	WIDTH C			WIDTH T	
LM245100 Series (cont)											
*LM245149DGW	228.600 9.0000	95.250 3.7500	1.5 .06	17.08 kg 37.67 lb	LM245110	311.150 12.2500	38.100 1.5000	3.3 .13	2.92 kg 6.43 lb	95.251 3.7500	LM245149DGW: GROOVE IN ID LM245149T: TAPERED BORE
LM245149DW	228.600 9.0000	95.250 3.7500	1.5 .06	17.10 kg 37.70 lb							
*LM245146TD	224.102 8.8229	104.775 4.1250	1.5 .06	20.33 kg 44.83 lb	LM245146TD may be paired with all single cups corresponding to LM245130T and will require -.508 mm (-.0200 in) to be added to the T-width values.						
LM245800 Series											
LM245833	220.878 8.6960	52.388 2.0625	3.3 .13	9.32 kg 20.55 lb	LM245810	317.500 12.5000	36.512 1.4375	3.3 .13	2.88 kg 6.36 lb	47.625 1.8750	
LM245846	230.188 9.0625	52.388 2.0625	3.3 .13	7.97 kg 17.56 lb							
LM245848	231.775 9.1250	52.388 2.0625	3.3 .13	7.73 kg 17.04 lb							
M246900 Series											
M246932	212.725 8.3750	65.088 2.5625	6.4 .25	16.38 kg 36.11 lb	M246910	336.550 13.2500	50.800 2.0000	3.3 .13	5.48 kg 12.08 lb	65.087 2.5625	
M246942	231.775 9.1250	65.088 2.5625	6.4 .25	12.98 kg 28.63 lb							
M246943	231.775 9.1250	69.850 2.7500	6.4 .25	13.38 kg 29.50 lb							
M246947	235.331 9.2650	69.850 2.7500	2.3 .09	12.82 kg 28.26 lb							
M246947AA	235.331 9.2650	65.088 2.5625	2.3 .09	12.42 kg 27.40 lb							
M246948	237.330 9.3437	69.850 2.7500	6.4 .25	12.39 kg 27.32 lb							
M246949	237.330 9.3437	65.088 2.5625	6.4 .25	11.94 kg 26.33 lb							
H247500 Series											
H247535	200.025 7.8750	112.712 4.4375	6.4 .25	43.43 kg 95.76 lb	H247510	384.175 15.1250	90.488 3.5625	6.4 .25	16.84 kg 37.13 lb	112.712 4.4375	H247545WS: KEYWAY IN ID FRONTFACE H247549WS: KEYWAY IN ID FRONTFACE
H247536	200.025 7.8750	112.712 4.4375	6.4 .25	-	*H247510CD	384.175 15.1250	193.675 7.6250	1.5 .06	35.74 kg 78.80 lb	238.124 9.3750	H247510CD : GROOVE IN OD CENTER HOLES IN OD CENTER
*H247545WS	231.775 9.1250	112.712 4.4375	6.4 .25	34.05 kg 75.07 lb							
H247548	234.950 9.2500	112.712 4.4375	6.4 .25	-							
H247549	234.950 9.2500	112.712 4.4375	6.4 .25	32.89 kg 72.53 lb							
*H247549WS	234.950 9.2500	112.712 4.4375	6.4 .25	32.89 kg 72.53 lb							
H247549D	234.950 9.2500	209.550 8.2500	1.5 .06	78.65 kg 173.43 lb	H247510	384.175 15.1250	90.488 3.5625	6.4 .25	16.84 kg 37.13 lb	209.549 8.2500	
LM247700 Series											
*LM247730T	234.686 9.2396	53.975 2.1250	3.3 .13	10.08 kg 22.22 lb	LM247710	327.025 12.8750	38.100 1.5000	3.3 .13	3.05 kg 6.72 lb	48.857 1.9235	LM247730T: REVERSE TAPERED BORE LM247747DGW: GROOVE IN ID
*LM247749T	247.650 9.7500	53.975 2.1250	3.3 .13	8.02 kg 17.68 lb	LM247714	329.949 12.9901	39.688 1.5625	3.3 .13	3.68 kg 8.12 lb	50.445 1.9860	SHOULDER ON ID RIGHTSIDE SLOTS IN RIGHTFACE LM247747TD: TAPERED BORE
*LM247747DGW	243.975 9.6053	123.000 4.8425	1.5 .06	20.16 kg 44.44 lb	LM247710	327.025 12.8750	38.100 1.5000	3.3 .13	3.05 kg 6.72 lb	92.075 3.6250	TQ/TQ0 (NON-INTERLOCKING)
LM247748D	244.475 9.6250	92.075 3.6250	1.5 .06	18.05 kg 39.81 lb	LM247714	329.949 12.9901	39.688 1.5625	3.3 .13	3.68 kg 8.12 lb	95.250 3.7500	LM247748DA: SLOTS IN LEFTFACE
*LM247748DA	244.475 9.6250	130.175 5.1250	1.5 .06	20.72 kg 45.69 lb							LM247748DGW: GROOVE IN ID
*LM247748DGW	244.475 9.6250	92.075 3.6250	1.5 .06	17.77 kg 39.18 lb							LM247749T: TAPERED BORE
LM247748DW	244.475 9.6250	92.075 3.6250	1.5 .06	18.03 kg 39.76 lb							
*LM247747TD	243.152 9.5729	101.600 4.0000	1.5 .06	20.22 kg 44.59 lb	LM247747TD may be paired with all single cups corresponding to LM247730T and will require -.711 mm (-.0280 in) to be added to the T-width values.						

\*\*These Maximum Fillet Radii will be cleared by the Cone or Cup Radii.  
†Bore or O.D. shown are maximum dimensions. \*See Remarks Column.

H249100 – M249700 SERIES

CONE			Max Shaft Fillet Radii R <sup>**</sup>	Weight	CUP			Max H's'ng Fillet Radii r <sup>**</sup>	Weight	BEARING	Remarks
Number	BORE d	WIDTH B			Number	OUTSIDE DIA D	WIDTH C			WIDTH T	
<b>H249100 Series</b>											
H249148	241.300 9.5000	100.012 3.9375	6.4 .25	67.76 kg 149.40 lb	*H249111CD	406.400 16.0000	184.150 7.2500	1.5 .06	34.73 kg 76.59 lb	215.900 8.5000	H249111CD : GROOVE IN OD CENTER HOLES IN OD CENTER
<b>LM249700 Series</b>											
LM249748	254.000 10.0000	42.862 1.6875	3.5 .14	15.84 kg 34.92 lb	*LM249710CD	347.662 13.6875	69.850 2.7500	1.5 .06	6.39 kg 14.08 lb	95.250 3.7500	LM249710CD : GROOVE IN OD CENTER HOLES IN OD CENTER
<b>M249700 Series</b>											
M249732	228.600 9.0000	71.438 2.8125	3.5 .14	20.22 kg 44.60 lb	M249710	358.775 14.1250	53.975 2.1250	3.3 .13	6.46 kg 14.24 lb	71.437 2.8125	M249730T: REVERSE TAPERED BORE
M249734	231.775 9.1250	71.438 2.8125	6.4 .25	19.50 kg 43.00 lb	*M249710-B	358.775 14.1250	53.975 2.1250	3.3 .13	7.32 kg 16.13 lb	30.162 1.1875	M249730TL: KEYWAY IN FRONTFACE REVERSE TAPERED BORE SHOULDER ON ID FRONTFACE
M249734H	231.775 9.1250	71.438 2.8125	6.4 .25	19.88 kg 43.83 lb	*M249710CD	358.775 14.1250	117.475 4.6250	1.5 .06	14.42 kg 31.80 lb	152.400 6.0000	M249731T: REVERSE TAPERED BORE
M249736	237.330 9.3437	71.438 2.8125	6.4 .25	18.36 kg 40.48 lb	*M249710DV	358.775 14.1250	117.475 4.6250	1.5 .06	14.93 kg 32.92 lb	152.400 6.0000	M249742TD: ASYMMETRICAL BEARING REVERSE TAPERED BORE
M249749	254.000 10.0000	71.438 2.8125	3.5 .14	14.84 kg 32.73 lb	*M249710DW	358.775 14.1250	133.350 5.2500	spcl. spcl.	15.30 kg 33.74 lb	152.400 6.0000	M249742TD: ASYMMETRICAL BEARING REVERSE TAPERED BORE
M249749H	254.000 10.0000	71.438 2.8125	3.5 .14	15.23 kg 33.59 lb	M249710V	358.775 14.1250	53.975 2.1250	3.3 .13	6.59 kg 14.53 lb	71.437 2.8125	M249745TA: REVERSE TAPERED BORE
M249749X	254.000 10.0000	71.438 2.8125	3.5 .14	14.84 kg 32.73 lb	M249710X	358.775 14.1250	53.975 2.1250	3.3 .13	6.46 kg 14.24 lb	71.437 2.8125	M249745TD: TAPERED BORE
					*M249711D	358.775 14.1250	117.475 4.6250	1.5 .06	14.70 kg 32.41 lb	152.400 6.0000	M249746TD: TAPERED BORE
											M249746TDG: GROOVE IN ID CENTER TAPERED BORE
*M249746TD	252.412 9.9375	139.700 5.5000	1.5 .06	38.09 kg 84.00 lb	M249710	358.775 14.1250	53.975 2.1250	3.3 .13	6.46 kg 14.24 lb	130.175 5.1250	M249747TD: TAPERED BORE TQI/TQO (NON-INTERLOCKING)
*M249746TDG	252.412 9.9375	139.700 5.5000	1.5 .06	38.03 kg 83.85 lb	M249710V	358.775 14.1250	53.975 2.1250	3.3 .13	6.59 kg 14.53 lb	130.175 5.1250	M249747TDL: TAPERED BORE TQI/TQO (INTERLOCKING)
M249748D	254.000 10.0000	130.175 5.1250	3.3 .13	34.46 kg 75.98 lb	M249710X	358.775 14.1250	53.975 2.1250	3.3 .13	6.46 kg 14.24 lb	130.175 5.1250	M249748DV: MADE FROM VACUUM MELT STEEL
*M249748DV	254.000 10.0000	130.175 5.1250	3.3 .13	34.46 kg 75.98 lb							M249748TD: TAPERED BORE TQI/TQO (NON-INTERLOCKING)
M249748DW	254.000 10.0000	130.175 5.1250	spcl. spcl.	34.46 kg 75.98 lb							M249748TD: TAPERED BORE TQI/TQO (NON-INTERLOCKING)
*M249749D	254.000 10.0000	130.175 5.1250	1.5 .06	34.46 kg 75.98 lb							M249749D: SHOULDER ON OD LEFTFACE
											M249749T: TAPERED BORE
M249747	257.175 10.1250	76.200 3.0000	1.5 .06	14.21 kg 31.34 lb	M249710	358.775 14.1250	53.975 2.1250	3.3 .13	6.46 kg 14.24 lb	71.437 2.8125	M249749TA: TAPERED BORE
M249749AH	254.000 10.0000	76.200 3.0000	1.5 .06	15.01 kg 33.10 lb	*M249710-B	358.775 14.1250	53.975 2.1250	3.3 .13	7.32 kg 16.13 lb	30.162 1.1875	M249749TE: SPECIAL BACKFACE RADIUS TAPERED BORE
					M249710V	358.775 14.1250	53.975 2.1250	3.3 .13	6.59 kg 14.53 lb	71.437 2.8125	M249749TE: SPECIAL BACKFACE RADIUS TAPERED BORE
					M249710X	358.775 14.1250	53.975 2.1250	3.3 .13	6.46 kg 14.24 lb	71.437 2.8125	M249749TLE: KEYWAY IN FRONTFACE SHOULDER ON ID FRONTFACE SPECIAL BACKFACE RADIUS TAPERED BORE
M249749NA	254.000 10.0000	76.200 3.0000	3.5 .14	30.30 kg 66.82 lb	*M249710CD	358.775 14.1250	117.475 4.6250	1.5 .06	14.42 kg 31.80 lb	152.400 6.0000	M249710-B : FLANGE ON OD FRONTFACE, BEARING WIDTH IS T1 DIMENSION
					*M249710DV	358.775 14.1250	117.475 4.6250	1.5 .06	14.93 kg 32.92 lb	152.400 6.0000	M249710CD : GROOVE IN OD CENTER HOLES IN OD CENTER
					*M249710DW	358.775 14.1250	133.350 5.2500	spcl. spcl.	15.30 kg 33.74 lb	152.400 6.0000	M249710DV : GROOVE IN OD CENTER HOLES IN OD CENTER
					*M249711D	358.775 14.1250	117.475 4.6250	1.5 .06	14.70 kg 32.41 lb	152.400 6.0000	M249710DW : GROOVE IN OD CENTER HOLES IN OD CENTER SPECIAL RADIUS ON LEFTFACE OD SPECIAL RADIUS ON RIGHTFACE OD

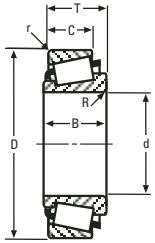

SINGLE ROW

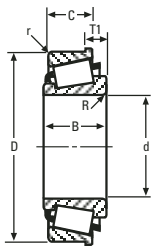

SINGLE ROW WITH FLANGE

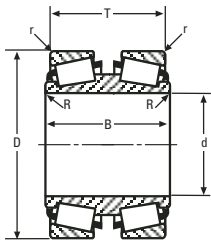

DOUBLE CONE

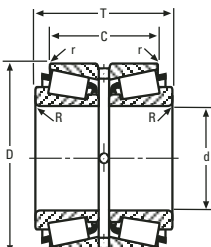

DOUBLE CUP

M249700 SERIES CONTINUED ON NEXT PAGE

\*\*These Maximum Fillet Radii will be cleared by the Cone or Cup Radii.  
†Bore or O.D. shown are maximum dimensions. \*See Remarks Column.

M249700 – HH249900 SERIES

CONE			Max Shaft Fillet Radii R <sup>**</sup>	Weight	CUP			Max Hs'ng Fillet Radii r <sup>**</sup>	Weight	BEAR-ING	Remarks
Number	BORE d	WIDTH B			Number	OUTSIDE DIA D	WIDTH C			WIDTH T	
<b>M249700 Series (cont)</b>											
*M249730T	240.772 9.4792	76.200 3.0000	3.3 .13	19.07 kg 42.06 lb	M249730T and grouped cones may be paired with all single cups corresponding to M249747 and will require -.305 mm (-.0120 in) to be added to the T-width values.					M249711D : HOLES IN OD CENTER	
*M249745TA	252.397 9.9369	76.200 3.0000	3.3 .13	16.64 kg 36.69 lb							
*M249749T	258.763 10.1875	76.200 3.0000	3.3 .13	14.91 kg 32.88 lb							
*M249749TA	258.763 10.1875	76.200 3.0000	3.3 .13	15.14 kg 33.38 lb							
*M249730TL	239.845 9.4427	71.438 2.8125	3.3 .13	19.85 kg 43.76 lb	M249730TL and grouped cones may be paired with all single cups corresponding to M249732 and will require -.305 mm (-.0120 in) to be added to the T-width values.						
*M249731T	239.845 9.4427	71.438 2.8125	3.3 .13	18.57 kg 40.95 lb	M249730TL and grouped cones may be paired with all double cups corresponding to M249732 and will require -.610 mm (-.0240 in) to be added to the T-width values.						
*M249742TD	242.745 9.5569	139.700 5.5000	3.3 .13	40.85 kg 90.07 lb	M249742TD and grouped cones may be paired with all single cups corresponding to M249746TD and will require -1.118 mm (-.0440 in) to be added to the T-width values.						
*M249745TD	253.594 9.9840	130.175 5.1250	3.3 .13	36.32 kg 80.08 lb							
*M249747TD	252.412 9.9375	139.700 5.5000	1.5 .06	38.08 kg 83.98 lb	M249747TD and grouped cones may be paired with all single cups corresponding to M249746TD and will require -.610 mm (-.0240 in) to be added to the T-width values.						
*M249747TDL	252.809 9.9531	155.575 6.1250	1.5 .06	39.00 kg 86.00 lb							
*M249748TD	252.809 9.9531	155.575 6.1250	1.5 .06	39.48 kg 87.05 lb							
*M249749TE	262.865 10.3490	120.650 4.7500	19.0 .75	21.19 kg 46.72 lb	M249749TE and grouped cones may be paired with all single cups corresponding to M249732 and will require 48.908 mm (1.9255 in) to be added to the T-width values.						
*M249749TLE	262.865 10.3490	120.650 4.7500	19.0 .75	21.04 kg 46.39 lb	M249749TE and grouped cones may be paired with all double cups corresponding to M249732 and will require 97.815 mm (3.8510 in) to be added to the T-width values.						
<b>HH249900 Series</b>											
HH249949	247.650 9.7500	117.475 4.6250	6.4 .25	-	HH249910 406.400 16.0000	93.662 3.6875	6.4 .25	19.41 kg 42.80 lb	115.888 4.5625	HH249949V: MADE FROM VACUUM MELT STEEL HH249910CD : GROOVE IN OD CENTER	
HH249949H	247.650 9.7500	117.475 4.6250	6.4 .25	-	*HH249910CDV 406.400 16.0000	203.200 8.0000	1.5 .06	42.32 kg 93.32 lb	247.650 9.7500	HOLES IN OD CENTER	
*HH249949V	247.650 9.7500	117.475 4.6250	6.4 .25	-	*HH249910CD 406.400 16.0000	203.200 8.0000	1.5 .06	42.32 kg 93.32 lb	247.650 9.7500	HH249910CDV : GROOVE IN OD CENTER HOLES IN OD CENTER	
HH249949D	247.650 9.7500	219.075 8.6250	3.3 .13	-	HH249910 406.400 16.0000	93.662 3.6875	6.4 .25	19.41 kg 42.80 lb	215.900 8.5000		

6

\*\*These Maximum Fillet Radii will be cleared by the Cone or Cup Radii.  
†Bore or O.D. shown are maximum dimensions. \*See Remarks Column.

250000 – M252300 SERIES

CONE			Max Shaft Fillet Radii R <sup>1</sup>	Weight	CUP			Max Hs'ng Fillet Radii r <sup>2</sup>	Weight	BEARING	Remarks
Number	BORE d	WIDTH B			Number	OUTSIDE DIA D	WIDTH C			WIDTH T	
<b>250000 Series</b>											
EE251000D	254.000 10.0000	104.775 4.1250	1.5 .06	40.61 kg 89.54 lb	251575	400.050 15.7500	41.275 1.6250	1.5 .06	8.35 kg 18.40 lb	107.950 4.2500	
EE251001	254.000 10.0000	55.562 2.1875	3.3 .13	16.53 kg 36.45 lb	251575	400.050 15.7500	41.275 1.6250	1.5 .06	8.35 kg 18.40 lb	57.150 2.2500	
<b>HM252300 Series</b>											
HM252340D	250.825 9.8750	139.700 5.5000	3.5 .14	69.66 kg 153.59 lb	HM252310	422.275 16.6250	66.675 2.6250	3.3 .13	12.39 kg 27.32 lb	152.400 6.0000	HM252340DW: KEYWAY IN ID
*HM252340DW	250.825 9.8750	139.700 5.5000	3.5 .14	69.66 kg 153.59 lb	HM252315	431.724 16.9970	60.325 2.3750	3.5 .14	14.13 kg 31.16 lb	145.258 5.7188	HM252341DW: KEYWAY IN ID HM252347T: REVERSE TAPERED BORE
*HM252341DW	250.825 9.8750	139.700 5.5000	3.5 .14	- -							HM252348WS: KEYWAY IN ID FRONTFACE
HM252343D	254.000 10.0000	139.700 5.5000	3.5 .14	68.28 kg 150.56 lb							HM252349T: TAPERED BORE
HM252347D	260.350 10.2500	139.700 5.5000	3.5 .14	65.48 kg 144.37 lb							HM252310CD : GROOVE IN OD CENTER HOLES IN OD CENTER
HM252343	254.000 10.0000	79.771 3.1406	6.8 .27	30.25 kg 66.71 lb	HM252310	422.275 16.6250	66.675 2.6250	3.3 .13	12.39 kg 27.32 lb	86.121 3.3906	HM252310DW : GROOVE IN OD CENTER HOLES IN OD CENTER
HM252344	254.000 10.0000	79.771 3.1406	6.8 .27	- -	*HM252310DW	422.275 16.6250	165.100 6.5000	1.5 .06	28.23 kg 62.25 lb	178.593 7.0312	
*HM252347T	252.115 9.9258	79.771 3.1406	6.8 .27	31.61 kg 69.71 lb	*HM252310CD	422.275 16.6250	139.700 5.5000	1.5 .06	24.56 kg 54.16 lb	178.592 7.0312	HM252311D : GROOVE IN OD CENTER HOLES IN OD CENTER
HM252348	260.350 10.2500	79.771 3.1406	6.8 .27	28.82 kg 63.54 lb	*HM252311D	422.275 16.6250	128.587 5.0625	1.5 .06	24.32 kg 53.63 lb	173.038 6.8125	HM252312D : GROOVE IN OD CENTER HOLES IN OD CENTER
*HM252348WS	260.350 10.2500	79.771 3.1406	6.8 .27	28.79 kg 63.48 lb	*HM252312D	422.910 16.6500	139.700 5.5000	1.5 .06	25.02 kg 55.18 lb	178.592 7.0312	
HM252349	260.350 10.2500	79.771 3.1406	6.8 .27	- -	HM252315	431.724 16.9970	60.325 2.3750	3.5 .14	14.13 kg 31.16 lb	82.550 3.2500	HM252315D : GROOVE IN OD CENTER HOLES IN OD CENTER
*HM252349T	260.350 10.2500	79.771 3.1406	6.8 .27	29.46 kg 64.97 lb	*HM252315DC	431.724 16.9970	128.587 5.0625	1.5 .06	30.69 kg 67.68 lb	173.038 6.8125	
					*HM252315D	431.724 16.9970	128.587 5.0625	1.5 .06	30.68 kg 67.64 lb	173.038 6.8125	HM252315DC : HOLES IN OD CENTER
HM252343NA	254.000 10.0000	86.517 3.4062	6.4 .25	- -	*HM252310DW	422.275 16.6250	165.100 6.5000	1.5 .06	28.23 kg 62.25 lb	173.035 6.8124	
HM252344NA	254.000 10.0000	86.517 3.4062	6.4 .25	- -	*HM252310CD	422.275 16.6250	139.700 5.5000	1.5 .06	24.56 kg 54.16 lb	173.035 6.8124	
HM252348NA	260.350 10.2500	86.517 3.4062	6.4 .25	- -	*HM252311D	422.275 16.6250	128.587 5.0625	1.5 .06	24.32 kg 53.63 lb	173.035 6.8124	
HM252349NA	260.350 10.2500	86.517 3.4062	6.4 .25	- -	*HM252312D	422.910 16.6500	139.700 5.5000	1.5 .06	25.02 kg 55.18 lb	173.035 6.8124	
					*HM252315DC	431.724 16.9970	128.587 5.0625	1.5 .06	30.69 kg 67.68 lb	173.035 6.8124	
					*HM252315D	431.724 16.9970	128.587 5.0625	1.5 .06	30.68 kg 67.64 lb	173.035 6.8124	
HM252348D	260.350 10.2500	152.400 6.0000	6.4 .25	66.85 kg 147.40 lb	HM252348D and grouped cones may be paired with all single cups corresponding to HM252340D and will require 3.175 mm (.1250 in) to be added to the T-width values.						
HM252348DW	260.350 10.2500	152.400 6.0000	6.4 .25	66.72 kg 147.12 lb							
HM252349D	260.350 10.2500	152.400 6.0000	6.4 .25	- -							
<b>M252300 Series</b>											
M252330	234.950 9.2500	74.612 2.9375	6.4 .25	26.21 kg 57.79 lb	M252310	381.000 15.0000	57.150 2.2500	3.3 .13	7.67 kg 16.91 lb	74.612 2.9375	M252330T: REVERSE TAPERED BORE
M252330X	234.950 9.2500	74.612 2.9375	6.4 .25	26.46 kg 58.35 lb	*M252310CD	381.000 15.0000	123.825 4.8750	1.5 .06	16.30 kg 35.94 lb	158.750 6.2500	M252331T: REVERSE TAPERED BORE
M252337	247.650 9.7500	74.612 2.9375	6.4 .25	23.29 kg 51.35 lb	M252310X	381.000 15.0000	57.150 2.2500	3.3 .13	7.67 kg 16.91 lb	74.612 2.9375	M252337WS: KEYWAY IN ID FRONTFACE M252338DW: KEYWAY IN ID SHOULDER ON OD LEFTFACE
*M252337WS	247.650 9.7500	74.612 2.9375	5.0 .20	23.29 kg 51.35 lb							M252344TD: EXTENDED SMALL RIB TAPERED BORE TQI/TQO (NON-INTERLOCKING)
M252349	269.875 10.6250	74.612 2.9375	6.4 .25	18.11 kg 39.93 lb							

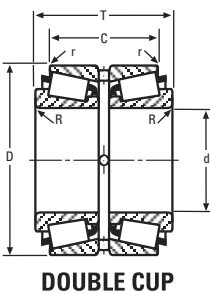
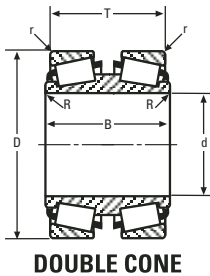
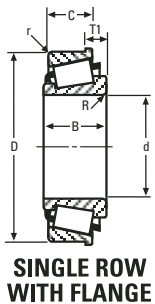
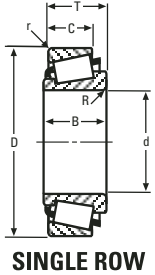

M252300 SERIES CONTINUED ON NEXT PAGE

<sup>1</sup>These Maximum Fillet Radii will be cleared by the Cone or Cup Radii.  
<sup>2</sup>Bore or O.D. shown are maximum dimensions. \*See Remarks Column.



M252300 – M255400 SERIES

7

CONE			Max Shaft Fillet Radii R''	Weight	CUP			Max Hs'ng Fillet Radii r''	Weight	BEAR-ING	Remarks
Number	BORE d	WIDTH B			Number	OUTSIDE DIA D	WIDTH C			WIDTH T	
<b>M252300 Series (cont)</b>											
M252349H	269.875 10.6250	74.612 2.9375	6.4 .25	18.26 kg 40.26 lb							
M252349HWS	269.875 10.6250	74.612 2.9375	6.4 .25	18.24 kg 40.23 lb							M252345TD: TAPERED BORE TQI/TQO (NON-INTERLOCKING)
*M252338DW	250.825 9.8750	136.525 5.3750	3.3 .13	49.53 kg 109.20 lb	M252310	381.000 15.0000	57.150 2.2500	3.3 .13	7.67 kg 16.91 lb	136.525 5.3750	M252348T: TAPERED BORE
M252349D	269.875 10.6250	136.525 5.3750	3.3 .13	41.19 kg 90.81 lb	M252310X	381.000 15.0000	57.150 2.2500	3.3 .13	7.67 kg 16.91 lb	136.525 5.3750	M252348TE: EXTENDED LARGE RIB SPECIAL BACKFACE RADIUS
*M252349DE	269.875 10.6250	196.850 7.7500	1.5 .06	45.82 kg 101.04 lb							TAPERED BORE
M252349DW	269.875 10.6250	136.525 5.3750	3.3 .13	41.14 kg 90.70 lb							M252349DE: EXTENDED SMALL RIB
*M252349TD	269.875 10.6250	136.525 5.3750	1.5 .06	43.74 kg 96.44 lb							M252349T: TAPERED BORE
*M252349TDE	272.390 10.7240	196.850 7.7500	1.5 .06	50.27 kg 110.86 lb							M252349TD: TAPERED BORE
*M252349TDG	269.875 10.6250	136.525 5.3750	1.5 .06	43.74 kg 96.44 lb							M252349TDE: EXTENDED SMALL RIB TAPERED BORE M252349TDG: GROOVE IN ID CENTER TAPERED BORE M252310CD : GROOVE IN OD CENTER HOLES IN OD CENTER
*M252330T	252.809 9.9531	77.788 3.0625	6.4 .25	-	- M252330T and grouped cones may be paired with all single cups corresponding to M252338DW and will require -2.096 mm (-.0825 in) to be added to the T-width values.						
*M252349T	271.462 10.6875	77.788 3.0625	6.4 .25	-							
*M252331T	251.485 9.9010	74.612 2.9375	6.4 .25	-	- M252331T and grouped cones may be paired with all single cups corresponding to M252330 and will require -2.096 mm (-.0825 in) to be added to the T-width values.						
*M252348T	271.462 10.6875	74.612 2.9375	6.4 .25	-	- M252331T and grouped cones may be paired with all double cups corresponding to M252330 and will require -4.191 mm (-.1650 in) to be added to the T-width values.						
*M252344TD	265.245 10.4427	165.100 6.5000	1.5 .06	-	- M252344TD and grouped cones may be paired with all single cups corresponding to M252338DW and will require -1.016 mm (-.0400 in) to be added to the T-width values.						
*M252345TD	264.980 10.4323	146.050 5.7500	3.3 .13	-							
*M252348TE	276.093 10.8698	130.175 5.1250	24.5 .96	-	- M252348TE may be paired with all single cups corresponding to M252330 and will require 53.467 mm (2.1050 in) to be added to the T-width values. - M252348TE may be paired with all double cups corresponding to M252330 and will require 106.934 mm (4.2100 in) to be added to the T-width values.						
<b>LM254300 Series</b>											
*LM254346DGW	285.750 11.2500	122.238 4.8125	1.5 .06	28.09 kg 61.94 lb	*LM254313X *LM254313W	380.898 14.9960	53.246 2.0963	5.5 .22	5.06 kg 11.16 lb	127.447 5.0176	LM254346DGW: ASYMMETRICAL BEARING GROOVE IN ID SHOULDER ON ID RIGHTSIDE LM254313W : SLOTS IN BACKFACE LM254313X : CHAMFER ON BACKFACE OD CHAMFER ON FRONTFACE OD SHOULDER ON OD BACKFACE
<b>HH255100 Series</b>											
HH255149D	279.400 11.0000	244.475 9.6250	1.5 .06	-	HH255110	457.200 18.0000	106.362 4.1875	6.4 .25	28.13 kg 62.02 lb	244.475 9.6250	
<b>M255400 Series</b>											
M255448	288.925 11.3750	77.788 3.0625	9.7 .38	-	M255410	406.400 16.0000	60.325 2.3750	3.3 .13	9.29 kg 20.49 lb	77.787 3.0625	M255429T: REVERSE TAPERED BORE M255445TD: TAPERED BORE TQI/TQO (NON-INTERLOCKING)
M255449	288.925 11.3750	77.788 3.0625	6.4 .25	-	*M255410DV	406.400 16.0000	130.175 5.1250	1.5 .06	20.24 kg 44.63 lb	165.100 6.5000	

\*\*These Maximum Fillet Radii will be cleared by the Cone or Cup Radii.  
†Bore or O.D. shown are maximum dimensions. \*See Remarks Column.

M255400 – HM256800 SERIES

CONE			Max Shaft Fillet Radii R <sup>**</sup>	Weight	CUP			Max Hs'ng Fillet Radii r <sup>**</sup>	Weight	BEARING WIDTH T	Remarks
Number	BORE d	WIDTH B			Number	OUTSIDE DIA D	WIDTH C				
<b>M255400 Series (cont)</b>											
M255449H	288.925 11.3750	77.788 3.0625	6.4 .25	-	*M255410CD	406.400 16.0000	130.175 5.1250	1.5 .06	19.63 kg 43.28 lb	165.100 6.5000	M255448T: TAPERED BORE
M255449V	288.925 11.3750	77.788 3.0625	6.4 .25	-	M255411	406.949 16.0216	61.000 2.4016	3.5 .14	9.53 kg 21.00 lb	77.907 3.0672	M255448TE: EXTENDED LARGE RIB SPECIAL BACKFACE RADIUS TAPERED BORE
M255449WS	288.925 11.3750	77.788 3.0625	6.4 .25	-							M255449D: SHOULDER ON OD LEFTFACE
*M255449D	288.925 11.3750	144.462 5.6875	3.3 .13	-	M255410	406.400 16.0000	60.325 2.3750	3.3 .13	9.29 kg 20.49 lb	144.462 5.6875	M255449DW: SHOULDER ON OD LEFTFACE SLOTS IN RIGHTFACE
*M255449DW	288.925 11.3750	144.462 5.6875	3.3 .13	-	M255411	406.949 16.0216	61.000 2.4016	3.5 .14	9.53 kg 21.00 lb	144.700 5.6969	M255449TD: TAPERED BORE
*M255449TD	288.925 11.3750	144.462 5.6875	3.3 .13	-							M255410CD : GROOVE IN OD CENTER HOLES IN OD CENTER
											M255410DV : GROOVE IN OD CENTER HOLES IN OD CENTER
*M255429T	269.583 10.6135	75.000 2.9528	3.5 .14	-	M255429T and grouped cones may be paired with all single cups corresponding to M255448 and will require -1.466 mm (-.0577 in) to be added to the T-width values.						
*M255448T	290.000 11.4173	75.000 2.9528	3.5 .14	-	M255429T and grouped cones may be paired with all double cups corresponding to M255448 and will require -2.931 mm (-.1154 in) to be added to the T-width values.						
*M255445TD	283.748 11.1712	169.997 6.6928	1.5 .06	-	M255445TD may be paired with all single cups corresponding to M255449D and will require .180 mm (.0071 in) to be added to the T-width values.						
*M255448TE	294.584 11.5978	130.002 5.1182	spcl. spcl.	-	M255448TE may be paired with all single cups corresponding to M255448 and will require 53.536 mm (2.1077 in) to be added to the T-width values. M255448TE may be paired with all double cups corresponding to M255448 and will require 107.071 mm (4.2154 in) to be added to the T-width values.						
<b>LM255700 Series</b>											
*LM255749DGW	294.975 11.6132	130.000 5.1181	-	29.31 kg 64.63 lb	LM255710	389.948 15.3523	43.658 1.7188	3.3 .13	4.88 kg 10.76 lb	105.731 4.1626	LM255749DGW: GROOVE IN ID SHOULDER ON ID RIGHTSIDE SLOTS IN RIGHTFACE
<b>HM256800 Series</b>											
*HM256839TA	297.508 11.7129	87.312 3.4375	6.4 .25	-	HM256810	422.275 16.6250	63.500 2.5000	3.3 .13	10.53 kg 23.22 lb	82.169 3.2350	HM256830T: REVERSE TAPERED BORE HM256839TA: REVERSE TAPERED BORE
*HM256849TA	304.800 12.0000	87.312 3.4375	6.4 .25	-							HM256845TD: TAPERED BORE TQI/TQO (NON-INTERLOCKING)
*HM256846TD	297.523 11.7135	160.338 6.3125	3.3 .13	-	HM256810	422.275 16.6250	63.500 2.5000	3.3 .13	10.53 kg 23.22 lb	150.813 5.9375	HM256846TD: TAPERED BORE
HM256849D	300.038 11.8125	150.812 5.9375	3.3 .13	-							HM256849T: TAPERED BORE
HM256849DA	300.038 11.8125	150.812 5.9375	6.4 .25	-							HM256849TA: TAPERED BORE
HM256849DW	300.038 11.8125	150.812 5.9375	3.3 .13	-							HM256810CD : GROOVE IN OD CENTER HOLES IN OD CENTER
											HM256810D : GROOVE IN OD CENTER HOLES IN OD CENTER
											HM256810DC : HOLES IN OD CENTER
											HM256810DW : GROOVE IN OD CENTER HOLES IN OD CENTER SPECIAL RADIUS ON LEFTFACE OD SPECIAL RADIUS ON RIGHTFACE OD
*HM256830T	284.162 11.1875	87.312 3.4375	6.4 .25	-	HM256830T and grouped cones may be paired with all single cups corresponding to HM256839TA and will require .076 mm (.0030 in) to be added to the T-width values.						
*HM256849T	304.800 12.0000	87.312 3.4375	6.4 .25	-							

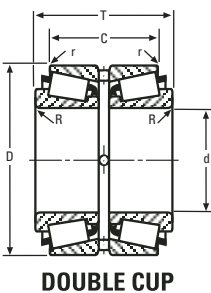
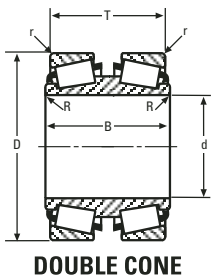
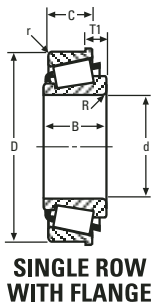
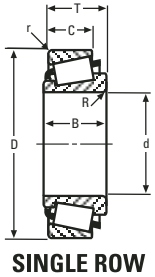

HM256800 SERIES CONTINUED ON NEXT PAGE

\*\*These Maximum Fillet Radii will be cleared by the Cone or Cup Radii.  
†Bore or O.D. shown are maximum dimensions. \*See Remarks Column.

HM256800 – LM258600 SERIES

CONE			Max Shaft Fillet Radii R''	Weight	CUP			Max Hs'ng Fillet Radii r''	Weight	BEAR-ING	Remarks
Number	BORE d	WIDTH B			Number	OUTSIDE DIA D	WIDTH C			WIDTH T	
HM256800 Series (cont)											
*HM256845TD	297.523 11.7135	160.338 6.3125	3.3 .13	-	HM256845TD may be paired with all single cups corresponding to HM256839TA and will require -.610 mm (-.0240 in) to be added to the T-width values.						
HM256849	300.038 11.8125	82.550 3.2500	6.4 .25	-	*HM256810DW	422.275 16.6250	152.400 6.0000	1.5 .06	23.76 kg 52.40 lb	174.625 6.8750	
					HM256810	422.275 16.6250	63.500 2.5000	3.3 .13	10.53 kg 23.22 lb	82.550 3.2500	
					*HM256810DC	422.275 16.6250	136.525 5.3750	1.5 .06	22.39 kg 49.37 lb	174.626 6.8750	
					*HM256810D	422.275 16.6250	136.525 5.3750	1.5 .06	22.39 kg 49.37 lb	174.626 6.8750	
					*HM256810CD	422.275 16.6250	136.525 5.3750	1.5 .06	22.11 kg 48.76 lb	174.626 6.8750	
M257100 Series											
M257149D	304.800 12.0000	130.175 5.1250	1.5 .06	42.38 kg 93.45 lb	M257110	419.100 16.5000	53.975 2.1250	6.4 .25	7.84 kg 17.29 lb	130.175 5.1250	
M257149DW	304.800 12.0000	130.175 5.1250	1.5 .06	42.44 kg 93.58 lb							
M257200 Series											
M257248D	304.902 12.0040	128.587 5.0625	3.3 .13	41.00 kg 90.41 lb	M257210	412.648 16.2460	53.975 2.1250	3.3 .13	7.92 kg 17.47 lb	128.587 5.0625	
*M257248DGW	304.902 12.0040	128.587 5.0625	3.3 .13	40.94 kg 90.28 lb							
M257248DW	304.902 12.0040	128.587 5.0625	3.3 .13	41.00 kg 90.41 lb						M257248DGW: GROOVE IN ID	
M257600 Series											
M257644DGW	304.648 11.9940	140.495 5.5313	1.5 .06	-	M257615W	438.048 17.2460	57.150 2.2500	4.8 .19	9.45 kg 20.84 lb	135.000 5.3150	
					M257615X	438.048 17.2460	59.850 2.3563	-	9.69 kg 21.37 lb	140.400 5.5276	
HH258200 Series											
HH258232	254.000 10.0000	141.288 5.5625	6.4 .25	-	HH258210	495.300 19.5000	114.300 4.5000	6.4 .25	34.81 kg 76.76 lb	141.287 5.5625	
HH258248	299.974 11.8100	141.288 5.5625	6.4 .25	-	*HH258210CD	495.300 19.5000	247.650 9.7500	1.5 .06	75.45 kg 166.36 lb	301.624 11.8750	
*HH258247TD	303.212 11.9375	263.525 10.3750	3.3 .13	-	HH258210	495.300 19.5000	114.300 4.5000	6.4 .25	34.81 kg 76.76 lb	263.524 10.3750	
HH258249D	303.212 11.9375	263.525 10.3750	3.3 .13	-							
*HH258249TD	303.212 11.9375	263.525 10.3750	3.3 .13	-							
LM258600 Series											
*LM258642TD	306.255 12.0573	134.938 5.3125	1.5 .06	49.40 kg 108.94 lb	LM258610	422.275 16.6250	53.975 2.1250	3.3 .13	7.83 kg 17.26 lb	128.588 5.0625	
*LM258648DGA	317.500 12.5000	134.938 5.3125	1.5 .06	40.97 kg 90.34 lb						LM258642TD: ASYMMETRICAL BEARING REVERSE TAPERED BORE	
*LM258648DGW	317.500 12.5000	128.587 5.0625	1.6 .06	39.55 kg 87.22 lb						LM258646TD: TAPERED BORE TQI/TQO (NON-INTERLOCKING)	
LM258648DW	317.500 12.5000	128.587 5.0625	1.5 .06	39.65 kg 87.43 lb						LM258648DGA: EXTENDED SMALL RIB GROOVE IN ID	
LM258649D	317.500 12.5000	128.587 5.0625	1.5 .06	39.69 kg 87.53 lb							
*LM258649TD	317.500 12.5000	134.938 5.3125	1.5 .06	43.70 kg 96.35 lb						LM258648DGW: GROOVE IN ID	
										LM258649T: TAPERED BORE	
*LM258649T	320.000 12.5984	74.483 2.9324	6.5 .26	17.59 kg 38.79 lb	LM258610	422.275 16.6250	53.975 2.1250	3.3 .13	7.83 kg 17.26 lb	67.729 2.6665	
										LM258649TD: ASYMMETRICAL BEARING TAPERED BORE	
										LM258649TE: EXTENDED SMALL RIB SPECIAL BACKFACE RADIUS TAPERED BORE	

7

\*\*These Maximum Fillet Radii will be cleared by the Cone or Cup Radii.  
†Bore or O.D. shown are maximum dimensions. \*See Remarks Column.

LM258600 – HM259000 SERIES

CONE			Max Shaft Fillet Radii R <sup>**</sup>	Weight	CUP			Max H's'ng Fillet Radii r <sup>**</sup>	Weight	BEAR-ING	Remarks
Number	BORE d	WIDTH B			Number	OUTSIDE DIA D	WIDTH C			WIDTH T	
LM258600 Series (cont)											
*LM258630T	302.039 11.8913	74.483 2.9324	6.5 .26	22.66 kg 49.97 lb	LM258610	422.275 16.6250	53.975 2.1250	3.3 .13	7.83 kg 17.26 lb	70.269 2.7665	HOLES IN OD CENTER
					*LM258610D	422.275 16.6250	120.650 4.7500	1.5 .06	17.50 kg 38.59 lb	153.239 6.0330	
*LM258646TD	313.792 12.3540	141.034 5.5525	3.5 .14	46.65 kg 102.85 lb	LM258646TD may be paired with all single cups corresponding to LM258642TD and will require -1.062 mm (-.0418 in) to be added to the T-width values.						
*LM258649TE	323.832 12.7493	120.482 4.7434	18.8 .74	22.83 kg 50.33 lb	LM258649TE may be paired with all single cups corresponding to LM258642TD and will require 46.000 mm (1.8110 in) to be added to the T-width values.						
HM258900 Series											
HM258949D	304.800 12.0000	161.925 6.3750	3.3 .13	- -	HM258910	501.650 19.7500	61.117 2.4062	6.4 .25	16.18 kg 35.68 lb	161.922 6.3749	
HM259000 Series											
*HM259038DW	298.450 11.7500	158.750 6.2500	3.3 .13	- -	HM259010	447.675 17.6250	68.262 2.6875	3.3 .13	12.70 kg 28.00 lb	158.750 6.2500	HM259030T: REVERSE TAPERED BORE HM259038DW: KEYWAY IN ID SHOULDER ON OD RIGHTFACE
*HM259047DGW	317.500 12.5000	158.750 6.2500	3.3 .13	65.37 kg 144.13 lb	HM259010V	447.675 17.6250	68.262 2.6875	3.3 .13	12.70 kg 28.00 lb	158.750 6.2500	
*HM259047DW	317.500 12.5000	158.750 6.2500	3.3 .13	65.37 kg 144.13 lb							HM259045TD: TAPERED BORE TQI/TQO (NON-INTERLOCKING)
*HM259049D	317.500 12.5000	158.750 6.2500	3.3 .13	- -							HM259045TDV: TAPERED BORE TQI/TQO (NON-INTERLOCKING)
*HM259049DH	317.500 12.5000	158.750 6.2500	3.3 .13	- -							
*HM259049DV	317.500 12.5000	158.750 6.2500	3.3 .13	- -							HM259047DGW: GROOVE IN ID SHOULDER ON OD RIGHTFACE
*HM259049DW	317.500 12.5000	158.750 6.2500	3.3 .13	- -							HM259047DW: SHOULDER ON OD RIGHTFACE
*HM259047WS	314.325 12.3750	85.725 3.3750	3.5 .14	29.16 kg 64.29 lb	HM259010	447.675 17.6250	68.262 2.6875	3.3 .13	12.70 kg 28.00 lb	85.725 3.3750	HM259047WS: KEYWAY IN ID FRONTFACE
HM259048	317.500 12.5000	85.725 3.3750	3.5 .14	28.03 kg 61.80 lb	*HM259010CD	447.675 17.6250	146.050 5.7500	1.5 .06	26.66 kg 58.79 lb	180.975 7.1250	HM259048TE: EXTENDED SMALL RIB SPECIAL BACKFACE RADIUS TAPERED BORE
*HM259048WS	317.500 12.5000	85.725 3.3750	3.5 .14	27.95 kg 61.64 lb	*HM259010D	447.675 17.6250	146.050 5.7500	1.5 .06	26.94 kg 59.40 lb	180.975 7.1250	
HM259049	317.500 12.5000	85.725 3.3750	3.5 .14	- -	*HM259010DC	447.675 17.6250	146.050 5.7500	1.5 .06	26.94 kg 59.40 lb	180.975 7.1250	HM259048WS: KEYWAY IN ID FRONTFACE
*HM259049H	317.500 12.5000	85.725 3.3750	3.5 .14	- -	HM259010V	447.675 17.6250	68.262 2.6875	3.3 .13	12.70 kg 28.00 lb	85.725 3.3750	HM259049D: SHOULDER ON OD RIGHTFACE
					HM259010XD	447.675 17.6250	146.050 5.7500	1.5 .06	27.13 kg 59.82 lb	180.975 7.1250	HM259049DH: SHOULDER ON OD RIGHTFACE
					*HM259011D	447.675 17.6250	150.812 5.9375	1.5 .06	26.49 kg 58.41 lb	185.737 7.3125	HM259049DV: SHOULDER ON OD RIGHTFACE
											HM259049DW: SHOULDER ON OD LEFTFACE HM259049H: GROOVE IN OD FRONTFACE NO SMALL RIB SHOULDER ON OD RIGHTFACE
											HM259010CD : GROOVE IN OD CENTER HOLES IN OD CENTER HM259010D : GROOVE IN OD CENTER HOLES IN OD CENTER HM259010DC : HOLES IN OD CENTER
											HM259011D : GROOVE IN OD CENTER HOLES IN OD CENTER
*HM259030T	301.691 11.8776	92.870 3.6563	6.0 .24	- -	HM259030T may be paired with all single cups corresponding to HM259038DW and will require -.660 mm (-.0260 in) to be added to the T-width values.						
*HM259045TD	316.111 12.4453	173.035 6.8124	3.0 .12	- -	HM259045TD and grouped cones may be paired with all single cups corresponding to HM259038DW and will require -1.321 mm (-.0520 in) to be added to the T-width values.						
*HM259045TDV	316.111 12.4453	173.035 6.8124	3.0 .12	- -							
*HM259048TE	328.480 12.9323	148.433 5.8438	23.2 .91	- -	HM259048TE may be paired with all single cups corresponding to HM259038DW and will require 54.902 mm (2.1615 in) to be added to the T-width values.						

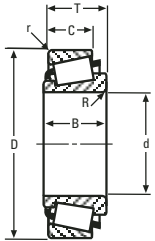

SINGLE ROW

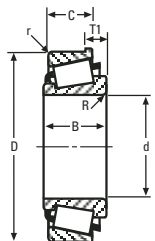

SINGLE ROW WITH FLANGE

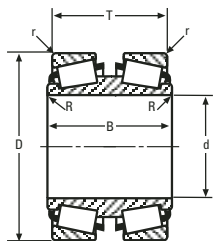

DOUBLE CONE

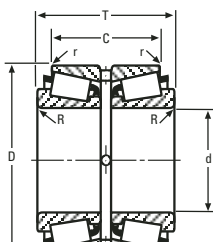

DOUBLE CUP

L259700 – M262400 SERIES

CONE			Max Shaft Fillet Radii R''	Weight	CUP			Max Hs'ng Fillet Radii r''	Weight	BEAR-ING	Remarks
Number	BORE d	WIDTH B			Number	OUTSIDE DIA D	WIDTH C			WIDTH T	
<b>L259700 Series</b>											
L259749D	330.200 13.0000	76.200 3.0000	1.5 .06	- -	L259710	414.338 16.3125	28.575 1.1250	3.3 .13	2.88 kg 6.36 lb	76.200 3.0000	
<b>260000 Series</b>											
*261601D	406.400 16.0000	136.525 5.3750	3.5 .14	- -	262450	622.300 24.5000	57.150 2.2500	6.8 .27	19.27 kg 42.49 lb	152.704 6.0120	261601D: NO SMALL RIB
EE261650D	419.100 16.5000	155.575 6.1250	3.5 .14	- -							
<b>M260100 Series</b>											
*M260148TD	317.632 12.5052	150.812 5.9375	3.3 .13	- -	M260110	444.500 17.5000	60.325 2.3750	3.3 .13	9.75 kg 21.51 lb	143.243 5.6395	M260148TD: ASYMMETRICAL BEARING REVERSE TAPERED BORE
*M260149TD	330.200 13.0000	150.812 5.9375	3.3 .13	- -							M260149DW: HOLES IN OD CENTER
*M260149DW	330.200 13.0000	144.462 5.6875	3.3 .13	- -	M260149DW may be paired with all single cups corresponding to M260148TD and will require 1.219 mm (.0480 in) to be added to the T-width values.						
<b>HM261000 Series</b>											
*HM261040TD	304.800 12.0000	166.688 6.5625	3.3 .13	- -	HM261010	469.900 18.5000	71.438 2.8125	3.3 .13	14.52 kg 32.01 lb	166.688 6.5625	HM261040TD: KEYWAY IN ID TAPERED BORE
HM261048D	333.375 13.1250	166.688 6.5625	8.0 .31	- -							HM261045T: REVERSE TAPERED BORE
HM261049D	333.375 13.1250	166.688 6.5625	3.3 .13	- -							HM261045TA: REVERSE TAPERED BORE
*HM261049DE	333.375 13.1250	238.125 9.3750	3.3 .13	- -							HM261047T: TAPERED BORE
HM261049DW	333.375 13.1250	166.688 6.5625	3.3 .13	- -							HM261047TA: TAPERED BORE
HM261049DWH	333.375 13.1250	166.688 6.5625	3.3 .13	75.85 kg 167.25 lb							HM261049AH: NO SMALL RIB
*HM261049TD	333.375 13.1250	166.688 6.5625	3.3 .13	- -							HM261049DE: EXTENDED SMALL RIB
*HM261045T	328.216 12.9219	90.488 3.5625	6.4 .25	- -	HM261010	469.900 18.5000	71.438 2.8125	3.3 .13	14.52 kg 32.01 lb	90.487 3.5625	HM261049TD: TAPERED BORE
*HM261047T	336.550 13.2500	90.488 3.5625	6.4 .25	- -	*HM261010CD	469.900 18.5000	152.400 6.0000	1.5 .06	25.98 kg 57.28 lb	190.500 7.5000	HM261010CD : GROOVE IN OD CENTER HOLES IN OD CENTER
HM261049	333.375 13.1250	90.488 3.5625	6.4 .25	- -	*HM261010DW	469.900 18.5000	177.800 7.0000	spcl. spcl.	34.68 kg 76.46 lb	190.500 7.5000	HM261010DW : GROOVE IN OD CENTER HOLES IN OD CENTER SPECIAL RADIUS ON LEFTFACE OD SPECIAL RADIUS ON RIGHTFACE OD
*HM261049AH	333.375 13.1250	90.996 3.5825	6.4 .25	33.45 kg 73.75 lb							
HM261049H	333.375 13.1250	90.488 3.5625	6.4 .25	32.58 kg 71.83 lb							
*HM261045TA	328.597 12.9369	95.250 3.7500	6.4 .25	36.85 kg 81.26 lb	HM261045TA and grouped cones may be paired with all single cups corresponding to HM261040TD and will require -.216 mm (-.0085 in) to be added to the T-width values.						
*HM261047TA	336.550 13.2500	95.250 3.7500	6.4 .25	33.79 kg 74.51 lb							
<b>LM262400 Series</b>											
LM262449DW	347.662 13.6875	125.412 4.9375	1.5 .06	- -	LM262410	469.900 18.5000	50.800 2.0000	3.3 .13	8.64 kg 19.04 lb	125.413 4.9375	
<b>M262400 Series</b>											
*M262430T	318.310 12.5319	90.488 3.5625	3.3 .13	40.17 kg 88.57 lb	M262410	469.900 18.5000	57.150 2.2500	3.3 .13	10.10 kg 22.28 lb	81.889 3.2240	M262430T: REVERSE TAPERED BORE
*M262447T	339.936 13.3833	90.488 3.5625	3.3 .13	32.28 kg 71.17 lb	M262410V	469.900 18.5000	57.150 2.2500	3.3 .13	10.10 kg 22.28 lb	81.889 3.2240	M262444TD: TAPERED BORE TQI/TQO (NON-INTERLOCKING)
*M262449D	347.662 13.6875	138.112 5.4375	3.3 .13	56.98 kg 125.64 lb	M262410	469.900 18.5000	57.150 2.2500	3.3 .13	10.10 kg 22.28 lb	138.112 5.4375	M262447T: TAPERED BORE
*M262449DW	347.662 13.6875	138.112 5.4375	- -	56.98 kg 125.64 lb	M262410V	469.900 18.5000	57.150 2.2500	3.3 .13	10.10 kg 22.28 lb	138.112 5.4375	M262448TD: TAPERED BORE
*M262449DWH	347.662 13.6875	138.112 5.4375	- -	56.98 kg 125.64 lb							M262449D: SHOULDER ON OD LEFTFACE
											M262449DW: SHOULDER ON OD LEFTFACE SLOTS IN RIGHTFACE
											M262449DWH: SHOULDER ON OD LEFTFACE SLOTS IN RIGHTFACE

\*\*These Maximum Fillet Radii will be cleared by the Cone or Cup Radii.  
†Bore or O.D. shown are maximum dimensions. \*See Remarks Column.

M262400 SERIES CONTINUED ON NEXT PAGE



M262400 – H263900 SERIES

CONE			Max Shaft Fillet Radii R <sup>**</sup>	Weight	CUP			Max Hs'ng Fillet Radii r <sup>**</sup>	Weight	BEARING	Remarks
Number	BORE d	WIDTH B			Number	OUTSIDE DIA D	WIDTH C			WIDTH T	
<b>M262400 Series (cont)</b>											
*M262444TD	332.395 13.0864	169.024 6.6545	3.3 .13	78.83 kg 173.82 lb	M262444TD may be paired with all single cups corresponding to M262430T and will require 13.716 mm (.5400 in) to be added to the T-width values.						
*M262448TD	347.662 13.6875	228.600 9.0000	3.3 .13	89.83 kg 198.08 lb	M262448TD may be paired with all single cups corresponding to M262430T and will require 90.488 mm (3.5625 in) to be added to the T-width values.						
<b>HM262700 Series</b>											
HM262748	346.075 13.6250	95.250 3.7500	6.4 .25	37.18 kg 81.97 lb	*HM262710V	488.950 19.2500	74.612 2.9375	3.3 .13	16.62 kg 36.66 lb	95.250 3.7500	HM262730T: REVERSE TAPERED BORE
HM262748WS	346.075 13.6250	95.250 3.7500	6.4 .25	37.18 kg 81.97 lb	HM262710	488.950 19.2500	74.612 2.9375	3.3 .13	16.62 kg 36.66 lb	95.250 3.7500	HM262746TD: TAPERED BORE
HM262749	346.075 13.6250	95.250 3.7500	6.4 .25	-	*HM262710CD	488.950 19.2500	158.750 6.2500	1.5 .06	34.69 kg 76.50 lb	200.026 7.8750	HM262748TDH: TAPERED BORE
HM262749V	346.075 13.6250	95.250 3.7500	6.4 .25	-							HM262749DG: GROOVE IN ID
											HM262749T: TAPERED BORE
HM262748D	346.075 13.6250	174.625 6.8750	3.3 .13	87.24 kg 192.37 lb	*HM262710V	488.950 19.2500	74.612 2.9375	3.3 .13	16.62 kg 36.66 lb	174.626 6.8750	HM262749TD: TAPERED BORE
*HM262748TDH	346.075 13.6250	174.625 6.8750	3.3 .13	-	HM262710	488.950 19.2500	74.612 2.9375	3.3 .13	16.62 kg 36.66 lb	174.626 6.8750	HM262749TDGV: GROOVE IN ID CENTER TAPERED BORE
HM262749D	346.075 13.6250	174.625 6.8750	3.3 .13	-							HM262749TDH: TAPERED BORE
*HM262749DG	346.075 13.6250	174.625 6.8750	3.3 .13	-							HM262749TDV: TAPERED BORE
*HM262749TD	346.075 13.6250	174.625 6.8750	3.3 .13	-							HM262710CD : GROOVE IN OD CENTER HOLES IN OD CENTER
*HM262749TDGV	346.075 13.6250	174.625 6.8750	3.3 .13	-							HM262710V : MADE FROM VACUUM MELT STEEL
*HM262749TDH	346.075 13.6250	174.625 6.8750	3.3 .13	-							
*HM262749TDV	346.075 13.6250	174.625 6.8750	3.3 .13	-							
*HM262730T	328.745 12.9427	100.012 3.9375	6.4 .25	-	HM262730T and grouped cones may be paired with all single cups corresponding to HM262748D and will require -.457 mm (-.0180 in) to be added to the T-width values.						
*HM262749T	352.425 13.8750	100.012 3.9375	6.4 .25	-							
*HM262746TD	344.091 13.5469	184.150 7.2500	3.3 .13	-	HM262746TD may be paired with all single cups corresponding to HM262748D and will require -.914 mm (-.0360 in) to be added to the T-width values.						
<b>LM263100 Series</b>											
*LM263145TD	349.250 13.7500	120.650 4.7500	1.5 .06	47.94 kg 105.72 lb	LM263110	457.200 18.0000	50.800 2.0000	3.3 .13	7.74 kg 17.06 lb	120.649 4.7500	LM263145TD: TAPERED BORE
*LM263149D	355.600 14.0000	120.650 4.7500	1.5 .06	42.03 kg 92.67 lb	LM263112	458.470 18.0500	50.800 2.0000	3.3 .13	8.12 kg 17.91 lb	120.649 4.7500	LM263149D: SHOULDER ON OD LEFTFACE
*LM263149DA	355.600 14.0000	156.362 6.1560	1.5 .06	44.65 kg 98.45 lb							LM263149DA: ASYMMETRICAL BEARING
<b>M263300 Series</b>											
*M263330T	337.739 13.2968	88.900 3.5000	3.3 .13	-	M263310	488.950 19.2500	63.500 2.5000	3.3 .13	13.17 kg 29.05 lb	83.680 3.2945	M263330T: REVERSE TAPERED BORE
*M263349T	358.775 14.1250	88.900 3.5000	3.3 .13	-							M263346TD: REVERSE TAPERED BORE TQI/TQO (NON-INTERLOCKING)
M263349D	355.600 14.0000	153.988 6.0625	1.5 .06	-	M263310	488.950 19.2500	63.500 2.5000	3.3 .13	13.17 kg 29.05 lb	153.988 6.0625	M263349T: TAPERED BORE
M263349DW	355.600 14.0000	153.988 6.0625	1.5 .06	-							
*M263346TD	351.366 13.8333	163.512 6.4375	1.5 .06	-	M263346TD may be paired with all single cups corresponding to M263330T and will require -.914 mm (-.0360 in) to be added to the T-width values.						
<b>H263900 Series</b>											
H263949	339.948 13.3838	145.000 5.7087	14.0 .55	-	*H263910D	579.948 22.8326	241.000 9.4882	3.5 .14	104.49 kg 230.41 lb	304.998 12.0078	H263910D : GROOVE IN OD CENTER HOLES IN OD CENTER

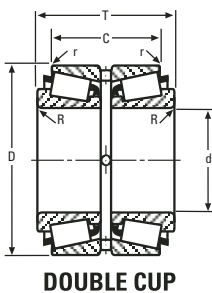
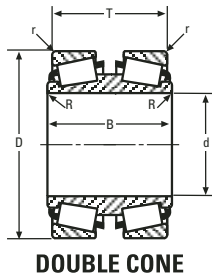
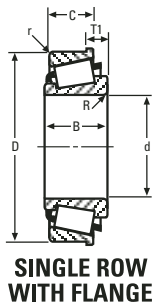
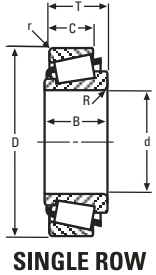

EH264000 SERIES CONTINUED ON NEXT PAGE

\*\*These Maximum Fillet Radii will be cleared by the Cone or Cup Radii.  
†Bore or O.D. shown are maximum dimensions. \*See Remarks Column.

**EH264000 – HM266400 SERIES**

CONE			Max Shaft Fillet Radii R <sup>**</sup>	Weight	CUP			Max Hs'ng Fillet Radii r <sup>**</sup>	Weight	BEAR-ING	Remarks
Number	BORE d	WIDTH B			Number	OUTSIDE DIA D	WIDTH C			WIDTH T	
<b>EH264000 Series</b>											
*EH264043CR	317.500 12.5000	188.912 7.4375	3.3 .13	-	*EH264013DR	673.100 26.5000	419.100 16.5000	3.3 .13	319.39 kg 704.26 lb	384.547 15.1396	EH264043CR: NO LARGE RIB STRAIGHT OD NO SMALL RIB SHOULDER ON OD FRONTFACE EH264013DR: SPECIAL RADIUS ON LEFTFACE OD SPECIAL RADIUS ON RIGHTFACE OD
<b>HH264100 Series</b>											
HH264149	339.948 13.3838	160.000 6.2992	14.0 .55	-	*HH264110CD	589.948 23.2263	278.000 10.9449	3.5 .14	128.71 kg 283.82 lb	340.002 13.3859	HH264110CD: GROOVE IN OD CENTER HOLES IN OD CENTER
<b>LL264600 Series</b>											
LL264648	374.650 14.7500	28.575 1.1250	3.5 .14	4.39 kg 9.68 lb	LL264610	431.800 17.0000	20.638 .8125	3.3 .13	1.80 kg 3.97 lb	28.575 1.1250	
<b>HM265000 Series</b>											
*HM265032TD	333.375 13.1250	185.738 7.3125	3.3 .13	-	HM265010	523.875 20.6250	79.375 3.1250	6.4 .25	20.78 kg 45.82 lb	185.737 7.3125	HM265032TD: TAPERED BORE HM265049D: SHOULDER ON OD LEFTFACE HM265049DGW: GROOVE IN ID HM265049DW: SHOULDER ON OD LEFTFACE SLOTS IN RIGHTFACE HM265049TD: TAPERED BORE HM265049TDG: GROOVE IN ID CENTER TAPERED BORE HM265010CD: GROOVE IN OD CENTER HOLES IN OD CENTER
*HM265049D	368.300 14.5000	185.738 7.3125	3.3 .13	-							
*HM265049DGW	368.300 14.5000	185.738 7.3125	3.3 .13	-							
*HM265049DW	368.300 14.5000	185.738 7.3125	3.3 .13	-							
*HM265049TD	368.300 14.5000	185.738 7.3125	3.3 .13	-							
*HM265049TDG	368.300 14.5000	185.738 7.3125	3.3 .13	-							
HM265049XD	368.300 14.5000	185.738 7.3125	3.3 .13	-							
HM265049	368.249 14.4980	101.600 4.0000	6.4 .25	-	HM265010	523.875 20.6250	79.375 3.1250	6.4 .25	20.78 kg 45.82 lb	101.600 4.0000	
					*HM265010CD	523.875 20.6250	169.862 6.6875	1.5 .06	43.63 kg 96.20 lb	214.312 8.4375	
<b>M265300 Series</b>											
*M265330T	353.261 13.9079	98.425 3.8750	3.3 .13	-	M265311	519.862 20.4670	74.612 2.9375	4.5 .18	17.09 kg 37.68 lb	93.307 3.6735	M265330T: REVERSE TAPERED BORE M265346TD: TAPERED BORE TQI/TQO (NON-INTERLOCKING) M265349T: TAPERED BORE M265349TE: EXTENDED LARGE RIB SPECIAL BACKFACE RADIUS TAPERED BORE
*M265349T	376.809 14.8350	98.425 3.8750	3.3 .13	-							
*M265346TD	368.607 14.5121	184.150 7.2500	1.5 .06	-	M265311	519.862 20.4670	74.612 2.9375	4.5 .18	17.09 kg 37.68 lb	173.914 6.8470	
*M265349TE	381.572 15.0225	155.575 6.1250	spcl. spcl.	-	M265349TE may be paired with all single cups corresponding to M265330T and will require 57.150 mm (2.2500 in) to be added to the T-width values.						
<b>HM266400 Series</b>											
*HM266444WS	377.825 14.8750	104.775 4.1250	6.4 .25	54.94 kg 121.15 lb	HM266410	546.100 21.5000	82.550 3.2500	6.4 .25	23.38 kg 51.56 lb	104.775 4.1250	HM266430T: REVERSE TAPERED BORE HM266432T: REVERSE TAPERED BORE HM266432TX: REVERSE TAPERED BORE HM266444WS: KEYWAY IN ID FRONTFACE HM266445D: SHOULDER ON OD RIGHTFACE HM266445TD: TAPERED BORE TQI/TQO (NON-INTERLOCKING) HM266445TDXX: TAPERED BORE TQI/TQO (NON-INTERLOCKING) HM266446TD: TAPERED BORE TQI/TQO (NON-INTERLOCKING)
HM266446	381.000 15.0000	104.775 4.1250	6.4 .25	53.29 kg 117.51 lb	*HM266410CD	546.100 21.5000	177.800 7.0000	1.5 .06	50.14 kg 110.56 lb	222.250 8.7500	
*HM266446WS	381.000 15.0000	104.775 4.1250	6.4 .25	53.29 kg 117.51 lb	*HM266410CDV	546.100 21.5000	177.800 7.0000	1.5 .06	50.14 kg 110.56 lb	222.250 8.7500	
HM266447	381.000 15.0000	104.775 4.1250	6.4 .25	-	HM266413	549.948 21.6515	82.550 3.2500	6.4 .25	25.52 kg 56.27 lb	104.775 4.1250	
HM266448	384.175 15.1250	104.775 4.1250	6.4 .25	51.73 kg 114.06 lb	HM266413XX	549.948 21.6515	82.550 3.2500	6.4 .25	25.55 kg 56.34 lb	104.775 4.1250	
HM266448WS	384.175 15.1250	104.775 4.1250	6.4 .25	51.73 kg 114.06 lb							
HM266449	384.175 15.1250	104.775 4.1250	6.4 .25	-							
*HM266449H	384.175 15.1250	104.775 4.1250	6.4 .25	52.35 kg 115.44 lb							

**7**

\*\*These Maximum Fillet Radii will be cleared by the Cone or Cup Radii.  
†Bore or O.D. shown are maximum dimensions. \*See Remarks Column.

HM266400 – EL268200 SERIES

CONE			Max Shaft Fillet Radii R <sup>1</sup>	Weight	CUP			Max Hs'ng Fillet Radii r <sup>2</sup>	Weight	BEARING	Remarks
Number	BORE d	WIDTH B			Number	OUTSIDE DIA D	WIDTH C			WIDTH T	
<b>HM266400 Series (cont)</b>											
*HM266449V	384.175 15.1250	104.775 4.1250	6.4 .25	-							HM266446WS: KEYWAY IN ID FRONTFACE
*HM266445D	374.574 14.7470	193.675 7.6250	3.3 .13	-	HM266410	546.100 21.5000	82.550 3.2500	6.4 .25	23.38 kg 51.56 lb	193.675 7.6250	HM266447T: TAPERED BORE
*HM266448DW	384.175 15.1250	193.675 7.6250	3.3 .13	122.06 kg 269.14 lb	HM266413	549.948 21.6515	82.550 3.2500	6.4 .25	25.52 kg 56.27 lb	193.675 7.6250	HM266448DW: SHOULDER ON OD RIGHTFACE SLOTS IN LEFTFACE
*HM266449D	384.175 15.1250	193.675 7.6250	3.3 .13	-	HM266413XX	549.948 21.6515	82.550 3.2500	6.4 .25	25.55 kg 56.34 lb	193.675 7.6250	HM266448T: TAPERED BORE
*HM266449DGW	384.175 15.1250	193.675 7.6250	3.3 .13	-							HM266448TXX: TAPERED BORE
*HM266449DW	384.175 15.1250	193.675 7.6250	3.3 .13	-							HM266449D: SHOULDER ON OD RIGHTFACE
*HM266449TD	384.175 15.1250	193.675 7.6250	3.3 .13	-							HM266449DGW: GROOVE IN ID SHOULDER ON OD RIGHTFACE SLOTS IN LEFTFACE
											HM266449DW: SHOULDER ON OD RIGHTFACE SLOTS IN LEFTFACE
											HM266449H: GROOVE IN OD FRONTFACE NO SMALL RIB SHOULDER ON OD RIGHTFACE
											HM266449T: TAPERED BORE
											HM266449TD: TAPERED BORE
											HM266449V: MADE FROM VACUUM MELT STEEL
											HM266410CD: GROOVE IN OD CENTER HOLES IN OD CENTER
											HM266410CDV: GROOVE IN OD CENTER HOLES IN OD CENTER
*HM266430T	364.066 14.3333	111.125 4.3750	6.4 .25	-	HM266430T and grouped cones may be paired with all single cups corresponding to HM266445D and will require -.508 mm (-.0200 in) to be added to the T-width values.						
*HM266432T	364.714 14.3588	111.125 4.3750	6.4 .25	-							
*HM266432TXX	364.714 14.3588	111.125 4.3750	6.4 .25	-							
*HM266447T	390.970 15.3925	111.125 4.3750	6.4 .25	-							
*HM266448T	391.071 15.3965	111.125 4.3750	6.4 .25	-							
*HM266448TXX	391.071 15.3965	111.125 4.3750	6.4 .25	-							
*HM266449T	390.525 15.3750	111.125 4.3750	6.4 .25	-							
*HM266445TD	381.861 15.0339	206.375 8.1250	3.3 .13	-	HM266445TD and grouped cones may be paired with all single cups corresponding to HM266445D and will require -1.016 mm (-.0400 in) to be added to the T-width values.						
*HM266445TDXX	381.861 15.0339	206.375 8.1250	3.3 .13	-							
*HM266446TD	381.264 15.0104	206.375 8.1250	3.3 .13	-							
<b>HH267600 Series</b>											
HH267648	379.948 14.9586	180.000 7.0866	14.0 .55	-	*HH267610D	659.925 25.9813	309.997 12.2046	3.5 .14	178.96 kg 394.60 lb	380.000 14.9606	HH267610D: GROOVE IN OD CENTER HOLES IN OD CENTER
<b>M267900 Series</b>											
M267949D	406.400 16.0000	184.150 7.2500	3.3 .13	-	M267910	565.150 22.2500	77.788 3.0625	6.4 .25	21.23 kg 46.80 lb	184.150 7.2500	
<b>EL268200 Series</b>											
EL268247H	422.750 16.6437	22.225 .8750	1.5 .06	2.99 kg 6.60 lb	EL268210	476.250 18.7500	16.251 .6398	1.5 .06	1.51 kg 3.34 lb	22.225 .8750	

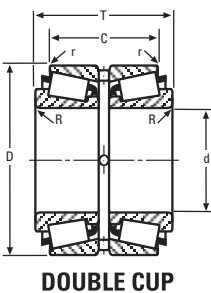
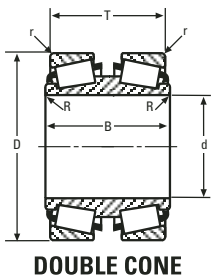
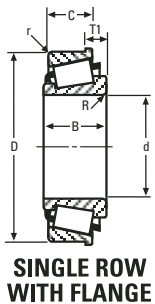
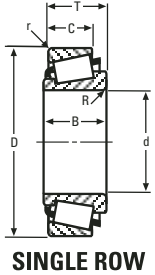

M268700 SERIES CONTINUED ON NEXT PAGE

<sup>1</sup>These Maximum Fillet Radii will be cleared by the Cone or Cup Radii.  
<sup>2</sup>Bore or O.D. shown are maximum dimensions. \*See Remarks Column.



M268700 – 270000 SERIES

CONE			Max Shaft Fillet Radii R''	Weight	CUP			Max Hs'ng Fillet Radii r''	Weight	BEAR-ING	Remarks
Number	BORE d	WIDTH B			Number	OUTSIDE DIA D	WIDTH C			WIDTH T	
<b>M268700 Series</b>											
*†JM268730DW	380.000 14.9606	260.000 10.2362	1.5 .06	-	M268710	590.550 23.2500	88.900 3.5000	6.4 .25	29.41 kg 64.86 lb	209.550 8.2500	M268729T: REVERSE TAPERED BORE JM268730DW: EXTENDED SMALL RIB
*M268743TD	406.400 16.0000	209.550 8.2500	3.3 .13	-	*†JM268711	590.000 23.2283	88.900 3.5000	3.0 .12	27.59 kg 60.83 lb	209.550 8.2500	M268743TD: TAPERED BORE
M268747DWH	415.925 16.3750	209.550 8.2500	3.3 .13	-							M268744WS: KEYWAY IN ID FRONTFACE
M268748D	415.925 16.3750	209.550 8.2500	9.7 .38	-							M268745TD: EXTENDED SMALL RIB TAPERED BORE TQI/TQO (NON-INTERLOCKING)
M268749D	415.925 16.3750	209.550 8.2500	3.3 .13	-							M268747T: TAPERED BORE
*M268749DGH	415.925 16.3750	209.550 8.2500	3.3 .13	-							M268749DGH: GROOVE IN ID
M268749DW	415.925 16.3750	209.550 8.2500	3.3 .13	-							M268749H: GROOVE IN OD FRONTFACE NO SMALL RIB SHOULDER ON OD FRONTFACE
M268749DWH	415.925 16.3750	209.550 8.2500	3.3 .13	-							M268749TD: TAPERED BORE
*M268749TD	415.925 16.3750	209.550 8.2500	3.3 .13	-							
*M268749TDG	415.925 16.3750	209.550 8.2500	3.3 .13	-							
M268730	381.000 15.0000	114.300 4.5000	6.4 .25	-	M268710	590.550 23.2500	88.900 3.5000	6.4 .25	29.41 kg 64.86 lb	114.300 4.5000	M268749TDG: GROOVE IN ID CENTER TAPERED BORE
*M268744WS	409.575 16.1250	114.300 4.5000	6.4 .25	-	*M268710CD	590.550 23.2500	193.675 7.6250	1.5 .06	64.08 kg 141.30 lb	244.475 9.6250	M268710CD: GROOVE IN OD CENTER HOLES IN OD CENTER
M268749	415.925 16.3750	114.300 4.5000	6.4 .25	-	*M268710D	590.550 23.2500	193.675 7.6250	1.5 .06	64.08 kg 141.30 lb	244.475 9.6250	M268710D : GROOVE IN OD CENTER HOLES IN OD CENTER
*M268749H	415.925 16.3750	114.300 4.5000	6.4 .25	68.51 kg 151.07 lb	*M268710DC	590.550 23.2500	193.675 7.6250	1.5 .06	66.75 kg 147.19 lb	244.475 9.6250	M268710DC : HOLES IN OD CENTER
M268749WS	415.925 16.3750	114.300 4.5000	6.4 .25	-	*†JM268711	590.000 23.2283	88.900 3.5000	3.0 .12	27.59 kg 60.83 lb	114.300 4.5000	M268711 : SHOULDER ON OD BACKFACE
*M268729T	390.129 15.3594	122.238 4.8125	6.4 .25	-	M268729T and grouped cones may be paired with all single cups corresponding to JM268730DW and will require -.559 mm (-.0220 in) to be added to the T-width values.						
*M268747T	419.100 16.5000	122.238 4.8125	6.4 .25	-							
*M268745TD	408.915 16.0990	225.425 8.8750	3.3 .13	-	M268745TD may be paired with all single cups corresponding to JM268730DW and will require -1.118 mm (-.0440 in) to be added to the T-width values.						
<b>L269100 Series</b>											
L269140	427.038 16.8125	50.800 2.0000	3.3 .13	-	L269110	533.400 21.0000	36.512 1.4375	3.3 .13	5.16 kg 11.38 lb	50.800 2.0000	
L269143	431.800 17.0000	50.800 2.0000	3.3 .13	-							
<b>270000 Series</b>											
*EE270537XS	136.525 5.3750	86.004 3.3860	10.7 .42	14.06 kg 31.00 lb	*271100	279.400 11.0000	63.500 2.5000	6.4 .25	9.31 kg 20.53 lb	82.550 3.2500	EE270537XS: SPECIAL BACKFACE CHAMFER
					271102-S	280.000 11.0236	61.912 2.4375	6.4 .25	8.74 kg 19.28 lb	82.550 3.2500	271100 : SPECIAL RADIUS ON BACKFACE OD
					*271125	285.750 11.2500	58.738 2.3125	6.4 .25	9.23 kg 20.35 lb	79.375 3.1250	SPECIAL RADIUS ON FRONTFACE OD
											271125 : SPECIAL RADIUS ON BACKFACE OD
											SPECIAL RADIUS ON FRONTFACE OD
EE270575XD	146.050 5.7500	171.450 6.7500	6.4 .25	34.61 kg 76.31 lb	*271100	279.400 11.0000	63.500 2.5000	6.4 .25	9.31 kg 20.53 lb	161.926 6.3750	
					271102-S	280.000 11.0236	61.912 2.4375	6.4 .25	8.74 kg 19.28 lb	161.925 6.3750	
					*271125	285.750 11.2500	58.738 2.3125	6.4 .25	9.23 kg 20.35 lb	155.575 6.1250	

7

†These Maximum Fillet Radii will be cleared by the Cone or Cup Radii.  
†Bore or O.D. shown are maximum dimensions. \*See Remarks Column.

M270400 – M270700 SERIES

CONE			Max Shaft Fillet Radii R <sup>**</sup>	Weight	CUP			Max Hs'ng Fillet Radii r <sup>**</sup>	Weight	BEARING WIDTH T	Remarks
Number	BORE d	WIDTH B			Number	OUTSIDE DIA D	WIDTH C				
<b>M270400 Series</b>											
*†JM270440D	440.000 17.3228	240.000 9.4488	1.5 .06	130.18 kg 287.04 lb	M270410	594.949 23.4232	75.000 2.9528	6.0 .24	20.26 kg 44.67 lb	178.000 7.0079	JM270440D: ASYMMETRICAL BEARING EXTENDED SMALL RIB
M270448D	449.948 17.7145	178.000 7.0079	3.0 .12	107.28 kg 236.56 lb	*†JM270411	590.000 23.2283	75.000 2.9528	3.0 .12	16.82 kg 37.10 lb	178.000 7.0079	M270448D: ASYMMETRICAL BEARING EXTENDED SMALL RIB
*M270448DWA	449.948 17.7145	184.000 7.2441	3.0 .12	108.69 kg 239.65 lb							M270449DA: HOLES IN OD CENTER
*M270449DA	449.948 17.7145	178.000 7.0079	3.0 .12	-							JM270411 : SHOULDER ON OD BACKFACE
M270449DW	449.948 17.7145	178.000 7.0079	3.0 .12	-							
<b>M270700 Series</b>											
*M270730T	422.700 16.6417	128.587 5.0625	6.4 .25	-	M270710	635.000 25.0000	95.250 3.7500	6.4 .25	36.14 kg 79.68 lb	120.117 4.7290	M270730T: REVERSE TAPERED BORE
*M270730TV	422.700 16.6417	128.587 5.0625	6.4 .25	-	M270710V	635.000 25.0000	95.250 3.7500	6.4 .25	36.14 kg 79.68 lb	120.117 4.7290	M270730TV: REVERSE TAPERED BORE
*M270732T	422.775 16.6447	128.587 5.0625	6.4 .25	-							M270732T: REVERSE TAPERED BORE
*M270741T	453.263 17.8450	128.587 5.0625	6.4 .25	-							M270737TD: ASYMMETRICAL BEARING REVERSE TAPERED BORE
*M270749T	453.390 17.8500	128.587 5.0625	6.4 .25	-							M270739TD: TAPERED BORE
*M270749TV	453.390 17.8500	128.587 5.0625	6.4 .25	-							M270741T: TAPERED BORE
*M270737TD	426.890 16.8067	231.775 9.1250	3.3 .13	-	M270710	635.000 25.0000	95.250 3.7500	6.4 .25	36.14 kg 79.68 lb	223.838 8.8125	M270742TD: TAPERED BORE TQI/TQO (NON-INTERLOCKING)
*M270747TD	446.204 17.5671	231.775 9.1250	3.3 .13	-	M270710V	635.000 25.0000	95.250 3.7500	6.4 .25	36.14 kg 79.68 lb	223.838 8.8125	M270743TE: BACKFACE CHAMFER EXTENDED LARGE RIB TAPERED BORE
*M270749ADW	447.675 17.6250	223.838 8.8125	3.3 .13	-							M270746TD: TAPERED BORE TQI/TQO (NON-INTERLOCKING)
*M270749ADWV	447.675 17.6250	223.838 8.8125	3.3 .13	-							M270746TD: TAPERED BORE TQI/TQO (NON-INTERLOCKING)
M270749D	447.675 17.6250	223.838 8.8125	3.3 .13	-							M270746TDV: TAPERED BORE TQI/TQO (NON-INTERLOCKING)
*M270749D	447.675 17.6250	223.838 8.8125	3.3 .13	-							M270747TD: ASYMMETRICAL BEARING EXTENDED SMALL RIB TAPERED BORE
*M270749D	447.675 17.6250	223.838 8.8125	3.3 .13	-							M270747TD: ASYMMETRICAL BEARING EXTENDED SMALL RIB TAPERED BORE
*M270749TD	447.675 17.6250	223.838 8.8125	3.3 .13	-							M270749TD: TAPERED BORE
*M270749TDG	447.675 17.6250	223.838 8.8125	3.3 .13	-							M270749TDG: GROOVE IN ID CENTER TAPERED BORE
											M270749TV: TAPERED BORE
											M270710CD : GROOVE IN OD CENTER HOLES IN OD CENTER
											M270710D : GROOVE IN OD CENTER HOLES IN OD CENTER
											M270710DC : HOLES IN OD CENTER
											M270720D : GROOVE IN OD CENTER HOLES IN OD CENTER
M270730	409.575 16.1250	120.650 4.7500	6.4 .25	-	M270710	635.000 25.0000	95.250 3.7500	6.4 .25	36.14 kg 79.68 lb	120.650 4.7500	
M270744	444.500 17.5000	120.650 4.7500	6.4 .25	-	*M270710CD	635.000 25.0000	206.375 8.1250	1.5 .06	76.90 kg 169.57 lb	257.176 10.1250	
M270749	447.675 17.6250	120.650 4.7500	6.4 .25	-	*M270710D	635.000 25.0000	206.375 8.1250	1.5 .06	82.52 kg 181.96 lb	257.176 10.1250	

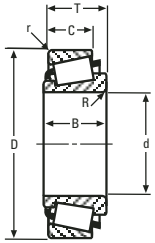

SINGLE ROW



SINGLE ROW WITH FLANGE

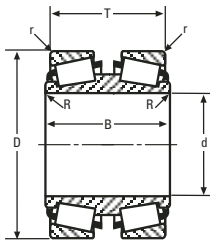

DOUBLE CONE

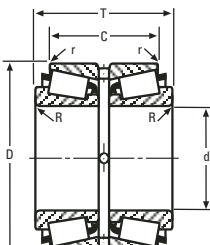

DOUBLE CUP

M270700 SERIES CONTINUED ON NEXT PAGE

\*\*These Maximum Fillet Radii will be cleared by the Cone or Cup Radii.  
†Bore or O.D. shown are maximum dimensions. \*See Remarks Column.

M270700 – LM272200 SERIES

CONE			Max Shaft Fillet Radii R''	Weight	CUP			Max Hs'ng Fillet Radii r''	Weight	BEAR-ING	Remarks
Number	BORE d	WIDTH B			Number	OUTSIDE DIA D	WIDTH C			WIDTH T	
<b>M270700 Series (cont)</b>											
M270749A	447.675 17.6250	120.650 4.7500	6.4 .25	79.06 kg 174.33 lb	*M270710DC 635.000 25.0000	206.375 8.1250	1.5 .06	82.52 kg 181.96 lb	257.176 10.1250		
					M270710V 635.000 25.0000	95.250 3.7500	6.4 .25	36.14 kg 79.68 lb	120.650 4.7500		
					*M270720D 649.925 25.5876	206.375 8.1250	1.5 .06	106.78 kg 235.46 lb	257.176 10.1250		
*M270739TD	442.648 17.4271	239.712 9.4375	3.3 .13	-	- M270739TD and grouped cones may be paired with all single cups corresponding to M270730T and will require -1.067 mm (-.0420 in) to be added to the T-width values.						
*M270742TD	442.598 17.4251	239.712 9.4375	3.3 .13	-							
*M270746TD	442.674 17.4281	239.712 9.4375	3.3 .13	-							
*M270746TDV	442.674 17.4281	239.712 9.4375	3.3 .13	-							
*M270743TE	460.571 18.1327	217.488 8.5625	spcl. spcl.	-	- M270743TE may be paired with all single cups corresponding to M270730T and will require 88.900 mm (3.5000 in) to be added to the T-width values.						
<b>M271100 Series</b>											
M271149D	459.948 18.1082	205.000 8.0709	3.0 .12	-	M271110	624.924 24.6033	88.000 3.4646	9.0 .35	28.16 kg 62.10 lb	205.000 8.0709	
<b>M271600 Series</b>											
M271648	457.200 18.0000	106.362 4.1875	6.4 .25	-	*M271610D	660.400 26.0000	171.450 6.7500	1.5 .06	63.26 kg 139.50 lb	228.600 9.0000	M271610D : GROOVE IN OD CENTER HOLES IN OD CENTER
					*M271610DC	660.400 26.0000	171.450 6.7500	1.5 .06	66.15 kg 145.86 lb	228.600 9.0000	M271610DC : HOLES IN OD CENTER
<b>LM272200 Series</b>											
LM272235	457.200 18.0000	85.725 3.3750	6.4 .25	54.31 kg 119.74 lb	LM272210	615.950 24.2500	66.675 2.6250	6.4 .25	16.66 kg 36.73 lb	85.725 3.3750	LM272246DGW: ASYMMETRICAL BEARING EXTENDED SMALL RIB GROOVE IN ID
LM272249	482.600 19.0000	85.725 3.3750	6.4 .25	41.73 kg 92.01 lb	*LM272210CD	615.950 24.2500	146.050 5.7500	1.5 .06	36.71 kg 80.96 lb	184.149 7.2500	LM272246DWA: ASYMMETRICAL BEARING EXTENDED SMALL RIB
LM272249A	482.600 19.0000	85.725 3.3750	15.0 .59	40.61 kg 89.54 lb	*LM272210D	615.950 24.2500	146.050 5.7500	1.5 .06	36.81 kg 81.18 lb	184.149 7.2500	LM272247DWA: ASYMMETRICAL BEARING EXTENDED SMALL RIB
					*LM272210DC	615.950 24.2500	146.050 5.7500	1.5 .06	38.44 kg 84.77 lb	184.149 7.2500	LM272247DGW: ASYMMETRICAL BEARING EXTENDED SMALL RIB
					*LM272210DV	615.950 24.2500	146.050 5.7500	1.5 .06	38.29 kg 84.43 lb	184.149 7.2500	LM272248DGW: GROOVE IN ID
					LM272210V	615.950 24.2500	66.675 2.6250	6.4 .25	16.66 kg 36.73 lb	85.725 3.3750	LM272248DWA: ASYMMETRICAL BEARING SLOTS IN LEFTFACE
*LM272246DGW	482.600 19.0000	165.100 6.5000	6.4 .25	97.12 kg 214.15 lb	LM272210	615.950 24.2500	66.675 2.6250	6.4 .25	16.66 kg 36.73 lb	158.750 6.2500	LM272249ADW: HOLES IN OD CENTER
*LM272246DWA	482.600 19.0000	165.100 6.5000	6.4 .25	97.12 kg 214.15 lb	LM272210V	615.950 24.2500	66.675 2.6250	6.4 .25	16.66 kg 36.73 lb	158.750 6.2500	LM272249DGW: GROOVE IN ID
*LM272247DWA	482.600 19.0000	165.100 6.5000	6.4 .25	97.02 kg 213.92 lb							LM272249DWA: ASYMMETRICAL BEARING SLOTS IN LEFTFACE
*LM272248DGW	482.600 19.0000	158.750 6.2500	6.4 .25	95.51 kg 210.61 lb							LM272210CD : GROOVE IN OD CENTER HOLES IN OD CENTER
LM272248DW	482.600 19.0000	158.750 6.2500	6.4 .25	95.62 kg 210.83 lb							
*LM272248DWA	482.600 19.0000	196.850 7.7500	4.0 .16	103.21 kg 227.58 lb							LM272210D : GROOVE IN OD CENTER HOLES IN OD CENTER
LM272248DWH	482.600 19.0000	158.750 6.2500	6.4 .25	95.62 kg 210.83 lb							LM272210DC : HOLES IN OD CENTER
*LM272249ADW	482.600 19.0000	158.750 6.2500	3.3 .13	95.64 kg 210.88 lb							LM272210DV : GROOVE IN OD CENTER HOLES IN OD CENTER
LM272249D	482.600 19.0000	158.750 6.2500	3.3 .13	95.79 kg 211.21 lb							
*LM272249DGW	482.600 19.0000	158.750 6.2500	3.3 .13	95.56 kg 210.70 lb							
LM272249DW	482.600 19.0000	158.750 6.2500	3.3 .13	95.64 kg 210.88 lb							
*LM272249DWA	482.600 19.0000	203.200 8.0000	3.3 .13	104.45 kg 230.31 lb							

\*\*These Maximum Fillet Radii will be cleared by the Cone or Cup Radii.  
†Bore or O.D. shown are maximum dimensions. \*See Remarks Column.

LM272200 SERIES CONTINUED ON NEXT PAGE



LM272200 – M272700 SERIES

CONE			Max Shaft Fillet Radii R <sup>**</sup>	Weight	CUP			Max Hs'ng Fillet Radii r <sup>**</sup>	Weight	BEARING	Remarks
Number	BORE d	WIDTH B			Number	OUTSIDE DIA D	WIDTH C			WIDTH T	
LM272200 Series (cont)											
LM272249DWH	482.600 19.0000	158.750 6.2500	3.3 .13	95.88 kg 211.41 lb							
LM272249DWW	482.600 19.0000	158.750 6.2500	3.3 .13	95.88 kg 211.41 lb							
LM272300 Series											
*LM272343DGW	482.600 19.0000	165.100 6.5000	6.4 .25	95.29 kg 210.11 lb	*LM272314W 615.950 24.2500	66.040 2.6000	6.4 .25	16.78 kg 37.00 lb	156.845 6.1750	LM272343DGW: ASYMMETRICAL BEARING EXTENDED SMALL RIB GROOVE IN ID	
*LM272344DGW	482.600 19.0000	165.100 6.5000	6.4 .25	95.29 kg 210.11 lb	*LM272314X 615.950 24.2500	70.294 2.7675	-	16.48 kg 36.34 lb	165.354 6.5100	SHOULDER ON ID LEFTSIDE	
					*LM272314XA 615.950 24.2500	71.796 2.8266	-	16.98 kg 37.45 lb	168.356 6.6282	LM272344DGW: ASYMMETRICAL BEARING EXTENDED SMALL RIB GROOVE IN ID SHOULDER ON ID LEFTSIDE SLOTS IN RIGHTFACE	
										LM272314W : SLOTS IN BACKFACE LM272314X : SHOULDER ON OD BACKFACE LM272314XA : SHOULDER ON OD BACKFACE	
LM272400 Series											
M272449D	482.600 19.0000	200.025 7.8750	3.0 .12	- -	M272410 635.000 25.0000	84.138 3.3125	6.4 .25	25.63 kg 56.51 lb	200.025 7.8750		
L272500 Series											
*L272543DGW	482.600 19.0000	181.610 7.1500	3.3 .13	93.43 kg 206.02 lb	*L272512 615.950 24.2500	79.375 3.1250	6.0 .24	18.37 kg 40.52 lb	181.610 7.1500	L272543DGW: EXTENDED SMALL RIB GROOVE IN ID  L272512 : CHAMFER ON BACKFACE OD GROOVE IN OD CENTER	
M272600 Series											
M272647DW	482.600 19.0000	201.612 7.9375	3.3 .13	- -	M272610 647.700 25.5000	85.725 3.3750	6.4 .25	28.98 kg 63.90 lb	201.613 7.9375		
M272700 Series											
*M272737TD	459.582 18.0938	257.175 10.1250	3.3 .13	- -	M272710 679.450 26.7500	101.600 4.0000	6.4 .25	43.59 kg 96.12 lb	238.124 9.3750	M272730T: REVERSE TAPERED BORE M272737TD: ASYMMETRICAL BEARING TAPERED BORE	
*M272740DW	457.200 18.0000	238.125 9.3750	3.3 .13	- -						M272740DW: KEYWAY IN ID	
M272749D	479.425 18.8750	238.125 9.3750	3.3 .13	- -						M272746TD: TAPERED BORE TQI/TQO (NON-INTERLOCKING)	
*M272749DGW	479.425 18.8750	238.125 9.3750	3.3 .13	- -						M272749DGW: GROOVE IN ID	
M272749DW	479.425 18.8750	238.125 9.3750	3.3 .13	- -						M272749D: GROOVE IN OD FRONTFACE	
*M272749TD	479.425 18.8750	238.125 9.3750	3.3 .13	- -							
M272749	479.425 18.8750	128.587 5.0625	6.4 .25	- -	M272710 679.450 26.7500	101.600 4.0000	6.4 .25	43.59 kg 96.12 lb	128.587 5.0625	M272749T: TAPERED BORE	
*M272749H	479.425 18.8750	131.762 5.1875	6.4 .25	98.74 kg 217.73 lb	*M272710D 679.450 26.7500	222.250 8.7500	1.5 .06	94.83 kg 209.10 lb	276.224 10.8750	M272749TD: TAPERED BORE	
M272749V	479.425 18.8750	128.587 5.0625	6.4 .25	- -	*M272710CD 679.450 26.7500	222.250 8.7500	1.5 .06	94.62 kg 208.65 lb	276.224 10.8750	M272749TE: EXTENDED LARGE RIB SPECIAL BACKFACE RADIUS TAPERED BORE M272710CD : GROOVE IN OD CENTER HOLES IN OD CENTER M272710D : GROOVE IN OD CENTER HOLES IN OD CENTER	
*M272730T	456.011 17.9532	138.112 5.4375	6.4 .25	- -	M272730T and grouped cones may be paired with all single cups corresponding to M272737TD and will require -.635 mm (-.0250 in) to be added to the T-width values.						
*M272749T	488.950 19.2500	138.112 5.4375	12.7 .50	- -							
*M272746TD	477.441 18.7969	257.175 10.1250	3.3 .13	- -	M272746TD may be paired with all single cups corresponding to M272737TD and will require -1.270 mm (-.0500 in) to be added to the T-width values.						

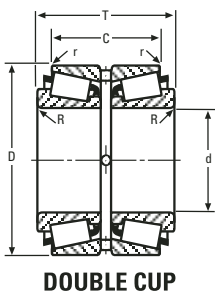
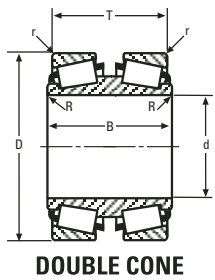
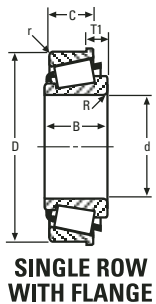
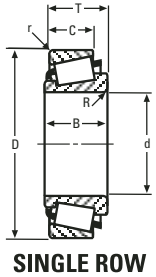

M272700 SERIES CONTINUED ON NEXT PAGE

\*\*These Maximum Fillet Radii will be cleared by the Cone or Cup Radii.  
†Bore or O.D. shown are maximum dimensions. \*See Remarks Column.

M272700 – 275000 SERIES

CONE			Max Shaft Fillet Radii R''	Weight	CUP			Max Hs'ng Fillet Radii r''	Weight	BEAR-ING	Remarks
Number	BORE d	WIDTH B			Number	OUTSIDE DIA D	WIDTH C			WIDTH T	
<b>M272700 Series (cont)</b>											
*M272749TE	496.888 19.5625	233.362 9.1875	39.6 1.56	-	M272749TE may be paired with all single cups corresponding to M272737TD and will require 94.615 mm (3.7250 in) to be added to the T-width values..						
<b>LM273900 Series</b>											
†JLM273947DG	510.000 20.0787	188.500 7.4213	1.5 .06	126.81 kg 279.62 lb	†JLM273914W 655.000 25.7874	80.000 3.1496	-	23.22 kg 51.19 lb	182.047 7.1672		
					†JLM273914X 655.000 25.7874	84.953 3.3446	-	23.91 kg 52.72 lb	191.953 7.5572		
<b>LM274000 Series</b>											
*LM274030TA	480.220 18.9063	117.284 4.6175	6.4 .25	-	LM274010 695.325 27.3750	80.962 3.1875	6.0 .24	33.95 kg 74.87 lb	108.877 4.2865	LM274030T: REVERSE TAPERED BORE LM274030TA: REVERSE TAPERED BORE	
*LM274040TA	490.009 19.2917	117.284 4.6175	6.4 .25	-						LM274040TA: TAPERED BORE	
*LM274046TD	498.211 19.6146	215.900 8.5000	3.3 .13	-	LM274010 695.325 27.3750	80.962 3.1875	6.0 .24	33.95 kg 74.87 lb	198.805 7.8270	LM274046TD: TAPERED BORE LM274049T: TAPERED BORE	
*LM274030T	480.220 18.9063	117.475 4.6250	6.4 .25	-	LM274030T and grouped cones may be paired with all single cups corresponding to LM274030TA and will require .051 mm (.0020 in) to be added to the T-width values.						
*LM274049T	508.000 20.0000	117.475 4.6250	6.4 .25	-							
LM274049DW	508.000 20.0000	200.025 7.8750	3.3 .13	-	LM274049DW may be paired with all single cups corresponding to LM274030TA and will require 1.219 mm (.0480 in) to be added to the T-width values						
<b>M274100 Series</b>											
*M274148DH	501.650 19.7500	250.825 9.8750	3.3 .13	-	M274110 711.200 28.0000	106.362 4.1875	6.4 .25	50.54 kg 111.43 lb	250.825 9.8750	M274148DH: SHOULDER ON OD LEFTFACE	
*M274149D	501.650 19.7500	250.825 9.8750	3.3 .13	-	M274110V 711.200 28.0000	106.362 4.1875	6.4 .25	50.68 kg 111.74 lb	250.825 9.8750	M274149D: SHOULDER ON OD LEFTFACE	
*M274149DH	501.650 19.7500	250.825 9.8750	3.3 .13	-						M274149DH: SHOULDER ON OD LEFTFACE	
M274149DW	501.650 19.7500	250.825 9.8750	3.3 .13	-						M274149TD: TAPERED BORE	
M274149DWW	501.650 19.7500	250.825 9.8750	3.3 .13	-						M274149TDG: GROOVE IN ID CENTER TAPERED BORE	
*M274149TD	501.650 19.7500	250.825 9.8750	3.3 .13	-						M274110D : GROOVE IN OD CENTER HOLES IN OD CENTER	
*M274149TDG	501.650 19.7500	250.825 9.8750	3.3 .13	-						M274110DC : HOLES IN OD CENTER	
M274149	501.650 19.7500	136.525 5.3750	6.4 .25	-	M274110 711.200 28.0000	106.362 4.1875	6.4 .25	50.54 kg 111.43 lb	136.525 5.3750	M274110DV : GROOVE IN OD CENTER HOLES IN OD CENTER	
					*M274110D 711.200 28.0000	231.775 9.1250	1.5 .06	110.15 kg 242.89 lb	292.100 11.5000		
					*M274110DC 711.200 28.0000	231.775 9.1250	1.5 .06	110.15 kg 242.89 lb	292.100 11.5000		
					*M274110DV 711.200 28.0000	231.775 9.1250	1.5 .06	110.15 kg 242.89 lb	292.100 11.5000		
					M274110V 711.200 28.0000	106.362 4.1875	6.4 .25	50.68 kg 111.74 lb	136.525 5.3750		
<b>LM274400 Series</b>											
LM274448DWH	514.350 20.2500	203.200 8.0000	3.3 .13	-	LM274410 673.100 26.5000	85.725 3.3750	6.4 .25	29.14 kg 64.25 lb	203.200 8.0000	LM274449DWA: ASYMMETRICAL BEARING EXTENDED SMALL RIB	
LM274449D	514.350 20.2500	203.200 8.0000	3.3 .13	-							
LM274449DW	514.350 20.2500	203.200 8.0000	3.3 .13	-							
*LM274449DWA	514.350 20.2500	211.138 8.3125	3.3 .13	-							
LM274449DWH	514.350 20.2500	203.200 8.0000	3.3 .13	-							
<b>275000 Series</b>											
EE275095	241.300 9.5000	69.850 2.7500	6.4 .25	25.48 kg 56.18 lb	275155 393.700 15.5000	50.005 1.9687	6.4 .25	6.59 kg 14.54 lb	73.817 2.9062	EE275109DGW: GROOVE IN ID 275156CD : GROOVE IN OD CENTER HOLES IN OD CENTER	

7

\*\*These Maximum Fillet Radii will be cleared by the Cone or Cup Radii.  
†Bore or O.D. shown are maximum dimensions. \*See Remarks Column.

275000 – M276400 SERIES

CONE			Max Shaft Fillet Radii R <sup>**</sup>	Weight	CUP			Max Hs'ng Fillet Radii r <sup>**</sup>	Weight	BEARING	Remarks
Number	BORE d	WIDTH B			Number	OUTSIDE DIA D	WIDTH C			WIDTH T	
<b>275000 Series (cont)</b>											
EE275100	254.000 10.0000	69.850 2.7500	6.4 .25	22.77 kg 50.22 lb	*275156DC	393.700 15.5000	109.538 4.3125	1.5 .06	15.56 kg 34.32 lb	157.162 6.1875	275156DC : HOLES IN OD CENTER
EE275105	266.700 10.5000	69.850 2.7500	6.4 .25	19.93 kg 43.95 lb	*275156D	393.700 15.5000	109.538 4.3125	1.5 .06	15.56 kg 34.32 lb	157.162 6.1875	275156D : GROOVE IN OD CENTER HOLES IN OD CENTER
EE275108	273.050 10.7500	69.850 2.7500	6.4 .25	18.46 kg 40.70 lb	*275156CD	393.700 15.5000	109.538 4.3125	1.5 .06	14.27 kg 31.46 lb	157.162 6.1875	275158-B : FLANGE ON OD FRONTFACE, BEARING WIDTH IS T1 DIMENSION
					*275158-B	403.225 15.8750	46.038 1.8125	6.4 .25	9.26 kg 20.42 lb	38.100 1.5000	
					275158	403.225 15.8750	46.038 1.8125	6.4 .25	7.98 kg 17.59 lb	69.850 2.7500	275161D : GROOVE IN OD CENTER HOLES IN OD CENTER
					275160	406.400 16.0000	46.038 1.8125	6.4 .25	8.70 kg 19.19 lb	69.850 2.7500	
					*275161DC	406.400 16.0000	107.950 4.2500	1.5 .06	21.20 kg 46.74 lb	155.575 6.1250	275161DC : HOLES IN OD CENTER
					*275161D	406.400 16.0000	107.950 4.2500	1.5 .06	21.20 kg 46.74 lb	155.575 6.1250	
EE275106D	266.700 10.5000	130.175 5.1250	3.3 .13	42.75 kg 94.27 lb	275155	393.700 15.5000	50.005 1.9687	6.4 .25	6.59 kg 14.54 lb	130.175 5.1250	
EE275109D	276.225 10.8750	130.175 5.1250	1.5 .06	42.37 kg 93.43 lb	275158	403.225 15.8750	46.038 1.8125	6.4 .25	7.98 kg 17.59 lb	122.240 4.8126	
*EE275109DGW	276.225 10.8750	130.175 5.1250	1.5 .06	42.32 kg 93.32 lb	275160	406.400 16.0000	46.038 1.8125	6.4 .25	8.70 kg 19.19 lb	122.240 4.8126	
EE275109DW	276.225 10.8750	130.175 5.1250	1.5 .06	42.37 kg 93.43 lb							
<b>LM275300 Series</b>											
LM275349D	520.700 20.5000	190.500 7.5000	3.3 .13	- -	LM275310	711.200 28.0000	79.375 3.1250	6.4 .25	32.33 kg 71.28 lb	190.507 7.5003	
<b>M275300 Series</b>											
*M275330T	494.505 19.4687	150.812 5.9375	6.4 .25	- -	M275310	736.600 29.0000	111.125 4.3750	6.4 .25	56.67 kg 124.96 lb	140.627 5.5365	M275330T: REVERSE TAPERED BORE
*M275349T	530.225 20.8750	150.812 5.9375	6.4 .25	- -							M275346TD: REVERSE TAPERED BORE TQ1/TQ0 (NON-INTERLOCKING)
M275349D	519.112 20.4375	258.763 10.1875	3.3 .13	- -	M275310	736.600 29.0000	111.125 4.3750	6.4 .25	56.67 kg 124.96 lb	258.762 10.1875	M275349T: TAPERED BORE
*M275349TD	519.112 20.4375	258.763 10.1875	3.3 .13	- -							M275349TD: TAPERED BORE
*M275346TD	517.657 20.3802	277.812 10.9375	3.3 .13	- -							M275346TD may be paired with all single cups corresponding to M275330T and will require -.1321 mm (-.0520 in) to be added to the T-width values.
<b>M276400 Series</b>											
*M276431T	510.520 20.0992	155.575 6.1250	6.4 .25	- -	M276410	761.873 29.9950	114.300 4.5000	6.4 .25	62.96 kg 138.83 lb	146.050 5.7500	M276430T: REVERSE TAPERED BORE
M276449	536.575 21.1250	146.050 5.7500	6.4 .25	- -	*M276410DC	761.873 29.9950	247.650 9.7500	1.5 .06	141.69 kg 312.42 lb	311.151 12.2500	M276431T: REVERSE TAPERED BORE
M276449AH	536.575 21.1250	146.050 5.7500	6.4 .25	- -	*M276410D	761.873 29.9950	247.650 9.7500	1.5 .06	134.26 kg 296.04 lb	311.151 12.2500	M276445TD: TAPERED BORE TQ1/TQ0 (NON-INTERLOCKING)
					*M276410CD	761.873 29.9950	247.650 9.7500	1.5 .06	134.10 kg 295.69 lb	311.151 12.2500	M276446TD: TAPERED BORE TQ1/TQ0 (NON-INTERLOCKING)
*M276448D	536.575 21.1250	269.875 10.6250	3.3 .13	- -	M276410	761.873 29.9950	114.300 4.5000	6.4 .25	62.96 kg 138.83 lb	269.876 10.6250	M276447TE: EXTENDED LARGE RIB SPECIAL BACKFACE RADIUS TAPERED BORE
*M276449ADW	536.575 21.1250	269.875 10.6250	3.3 .13	- -							M276448D: HOLES IN OD CENTER
M276449D	536.575 21.1250	269.875 10.6250	3.3 .13	- -							M276449ADW: HOLES IN OD CENTER
M276449DW	536.575 21.1250	269.875 10.6250	3.3 .13	- -							M276449T: TAPERED BORE M276410CD : GROOVE IN OD CENTER HOLES IN OD CENTER M276410D : GROOVE IN OD CENTER HOLES IN OD CENTER

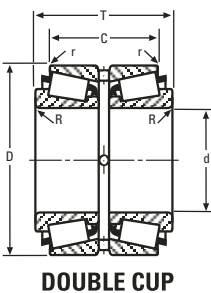
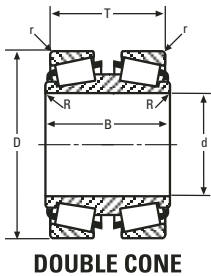
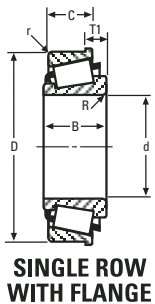
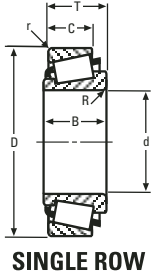

M276400 SERIES CONTINUED ON NEXT PAGE

\*\*These Maximum Fillet Radii will be cleared by the Cone or Cup Radii.  
†Bore or O.D. shown are maximum dimensions. \*See Remarks Column.

M276400 – LM278800 SERIES

CONE			Max Shaft Fillet Radii R <sup>1</sup>	Weight	CUP			Max Hs'ng Fillet Radii r <sup>1</sup>	Weight	BEARING	Remarks
Number	BORE d	WIDTH B			Number	OUTSIDE DIA D	WIDTH C			WIDTH T	
<b>M276400 Series (cont)</b>											
*M276430T	510.647 20.1042	155.575 6.1250	6.4 .25	-	M276430T	and grouped cones may be paired with all single cups corresponding to M276448D and will require -.711 mm (-.0280 in) to be added to the T-width values.					
*M276449T	547.688 21.5625	155.575 6.1250	6.4 .25	-							
*M276445TD	534.596 21.0471	288.925 11.3750	3.3 .13	-	M276445TD	and grouped cones may be paired with all single cups corresponding to M276448D and will require -1.422 mm (-.0560 in) to be added to the T-width values.					
*M276446TD	534.723 21.0521	288.925 11.3750	3.3 .13	-							
*M276447TE	555.234 21.8596	247.650 9.7500	45.2 1.78	-	M276447TE	may be paired with all single cups corresponding to M276448D and will require 91.364 mm (3.5970 in) to be added to the T-width values.					
<b>277000 Series</b>											
EE277455	1155.700 45.5000	120.650 4.7500	6.4 .25	-	277565	1435.100 56.5000	95.250 3.7500	6.4 .25	145.68 kg 321.22 lb	121.030 4.7650	
<b>LM277100 Series</b>											
*LM277149DA	558.800 22.0000	219.075 8.6250	3.3 .13	-	LM277110	736.600 29.0000	93.662 3.6875	6.4 .25	38.35 kg 84.57 lb	220.662 8.6875	
<b>M278700 Series</b>											
*M278741TD	546.633 21.5210	296.862 11.6875	3.3 .13	-	M278710	812.800 32.0000	120.650 4.7500	6.4 .25	75.91 kg 167.38 lb	285.750 11.2500	
*M278742TD	546.760 21.5260	296.862 11.6875	3.3 .13	-	M278710V	812.800 32.0000	120.650 4.7500	6.4 .25	76.80 kg 169.34 lb	285.750 11.2500	
*M278747TD	571.373 22.4950	296.862 11.6875	3.3 .13	-						M278747TD: ASYMMETRICAL BEARING TAPERED BORE	
M278748D	571.500 22.5000	285.750 11.2500	3.3 .13	-						M278748D: ASYMMETRICAL BEARING TAPERED BORE	
M278748DH	571.500 22.5000	285.750 11.2500	3.3 .13	-						M278748TD: ASYMMETRICAL BEARING TAPERED BORE	
M278748DV	571.500 22.5000	285.750 11.2500	3.3 .13	-						M278710CD : GROOVE IN OD CENTER HOLES IN OD CENTER	
*M278748TD	571.500 22.5000	296.862 11.6875	3.3 .13	-						M278710D : GROOVE IN OD CENTER HOLES IN OD CENTER	
M278749D	571.500 22.5000	285.750 11.2500	3.3 .13	-							
M278749DW	571.500 22.5000	285.750 11.2500	3.3 .13	-							
M278749	571.500 22.5000	155.575 6.1250	6.4 .25	-	M278710	812.800 32.0000	120.650 4.7500	6.4 .25	75.91 kg 167.38 lb	155.575 6.1250	
				-	*M278710CD	812.800 32.0000	263.525 10.3750	1.5 .06	168.42 kg 371.37 lb	333.375 13.1250	
				-	*M278710D	812.800 32.0000	263.525 10.3750	1.5 .06	160.05 kg 352.91 lb	333.375 13.1250	
				-	M278710V	812.800 32.0000	120.650 4.7500	6.4 .25	76.80 kg 169.34 lb	155.575 6.1250	
<b>LM278800 Series</b>											
LM278848D	585.788 23.0625	230.188 9.0625	6.4 .25	-	LM278810	771.525 30.3750	96.838 3.8125	6.4 .25	41.33 kg 91.14 lb	230.187 9.0625	
LM278849D	585.788 23.0625	230.188 9.0625	3.3 .13	-						LM278849DGW: GROOVE IN ID	
*LM278849DGW	585.788 23.0625	230.188 9.0625	3.3 .13	-						LM278810CD : GROOVE IN OD CENTER HOLES IN OD CENTER	
LM278849DW	585.788 23.0625	230.188 9.0625	3.3 .13	-						LM278810D : GROOVE IN OD CENTER HOLES IN OD CENTER	
*LM278849	585.788 23.0625	124.998 4.9212	6.4 .25	-	LM278810	771.525 30.3750	96.838 3.8125	6.4 .25	41.33 kg 91.14 lb	124.998 4.9212	
				-	*LM278810D	771.525 30.3750	212.725 8.3750	1.5 .06	89.22 kg 196.72 lb	269.047 10.5924	
				-	*LM278810CD	771.525 30.3750	212.725 8.3750	1.5 .06	47.06 kg 103.77 lb	269.047 10.5924	

<sup>1</sup>These Maximum Fillet Radii will be cleared by the Cone or Cup Radii.  
<sup>†</sup>Bore or O.D. shown are maximum dimensions. \*See Remarks Column.



280000 – LM281000 SERIES

CONE			Max Shaft Fillet Radii R <sup>**</sup>	Weight	CUP			Max Hs'ng Fillet Radii r <sup>**</sup>	Weight	BEARING WIDTH T	Remarks	
Number	BORE d	WIDTH B			Number	OUTSIDE DIA D	WIDTH C					
<b>280000 Series</b>												
EE280625D	158.750 6.2500	114.300 4.5000	3.3 .13	31.35 kg 69.12 lb	281200	304.800 12.0000	42.862 1.6875	3.3 .13	4.93 kg 10.86 lb	109.438 4.3086	EE280703DW: KEYWAY IN ID 281201D : GROOVE IN OD CENTER HOLES IN OD CENTER	
EE280700D	177.800 7.0000	114.300 4.5000	3.3 .13	26.83 kg 59.17 lb	281202	304.800 12.0000	42.862 1.6875	3.3 .13	5.12 kg 11.30 lb	109.438 4.3086	281201DC : HOLES IN OD CENTER	
*EE280703DW	177.800 7.0000	114.300 4.5000	3.3 .13	26.83 kg 59.17 lb								
EE280626	158.750 6.2500	69.106 2.7207	6.4 .25	15.45 kg 34.06 lb	281200	304.800 12.0000	42.862 1.6875	3.3 .13	4.93 kg 10.86 lb	66.675 2.6250		
EE280702	177.800 7.0000	69.106 2.7207	6.4 .25	12.72 kg 28.04 lb	*281201DC	304.800 12.0000	98.425 3.8750	1.5 .06	12.38 kg 27.30 lb	147.838 5.8204		
EE280720X	183.000 7.2047	69.106 2.7207	6.5 .26	11.91 kg 26.27 lb	*281201D  281202	304.800  304.800	98.425  42.862	1.5  3.3	12.38 kg  5.12 kg	147.838  66.675		
280970	177.800 7.0000	63.500 2.5000	1.5 .06	11.50 kg 25.36 lb	280970 may be paired with all single cups corresponding to EE280626 and will require -6.350 mm (-.2500 in) to be added to the T-width values. 280970 may be paired with all double cups corresponding to EE280626 and will require -12.700 mm (-.5000 in) to be added to the T-width values.							
<b>M280000 Series</b>												
*M280049D	595.312 23.4375	296.862 11.6875	3.3 .13	- -	M280010	844.550 33.2500	125.412 4.9375	6.4 .25	84.63 kg 186.62 lb	296.861 11.6875	M280049D: SHOULDER ON OD RIGHT FACE	
<b>LM280200 Series</b>												
LM280249DW	609.600 24.0000	227.012 8.9375	3.0 .12	- -	LM280210	813.562 32.0300	93.000 3.6614	6.4 .25	46.99 kg 103.62 lb	227.012 8.9375		
<b>M280200 Series</b>												
M280249D	603.250 23.7500	300.038 11.8125	3.3 .13	- -	M280210	857.250 33.7500	127.000 5.0000	6.4 .25	89.14 kg 196.54 lb	300.038 11.8125	M280249DGWA: GROOVE IN ID	
*M280249DGWA	603.250 23.7500	311.150 12.2500	3.3 .13	- -								
<b>M280300 Series</b>												
M280349D	609.600 24.0000	317.500 12.5000	3.3 .13	- -	M280310	863.600 34.0000	136.525 5.3750	6.4 .25	94.88 kg 209.21 lb	317.500 12.5000		
<b>LM281000 Series</b>												
*LM281031T	607.088 23.9011	141.288 5.5625	6.4 .25	- -	LM281010	857.250 33.7500	109.538 4.3125	6.4 .25	63.18 kg 139.30 lb	141.707 5.5790	LM281031T: REVERSE TAPERED BORE LM281031TV: REVERSE TAPERED BORE	
*LM281031TV	607.088 23.9011	141.288 5.5625	6.4 .25	- -	*LM281010CD	857.250 33.7500	241.300 9.5000	1.5 .06	141.31 kg 311.58 lb	305.639 12.0330	LM281044TD: TAPERED BORE TQI/TQO (NON-INTERLOCKING)	
*LM281048T	644.525 25.3750	141.288 5.5625	6.4 .25	- -	*LM281010D	857.250 33.7500	241.300 9.5000	1.5 .06	139.62 kg 307.87 lb	305.639 12.0330	LM281044TDV: TAPERED BORE TQI/TQO (NON-INTERLOCKING)	
*LM281048TV	644.525 25.3750	141.288 5.5625	6.4 .25	- -	LM281010V	857.250 33.7500	109.538 4.3125	6.4 .25	63.18 kg 139.30 lb	141.707 5.5790	LM281048T: TAPERED BORE LM281048TE: EXTENDED LARGE RIB SPECIAL BACKFACE RADIUS TAPERED BORE	
*LM281044TD	632.752 24.9115	307.975 12.1250	5.0 .20	- -	LM281010	857.250 33.7500	109.538 4.3125	6.4 .25	63.18 kg 139.30 lb	258.013 10.1580	LM281048TV: TAPERED BORE	
*LM281044TDV	632.752 24.9115	307.975 12.1250	5.0 .20	- -	LM281010V	857.250 33.7500	109.538 4.3125	6.4 .25	63.18 kg 139.30 lb	258.013 10.1580	LM281010CD : GROOVE IN OD CENTER HOLES IN OD CENTER LM281010D : GROOVE IN OD CENTER HOLES IN OD CENTER LM281011 : GROOVE IN OD BACKFACE	
*LM281048TE	651.934 25.6667	230.188 9.0625	spcl. spcl.	- -	*LM281011	857.250 33.7500	109.538 4.3125	6.4 .25	62.09 kg 136.90 lb	141.707 5.5790	LM281048TE may be paired with all single cups corresponding to LM281031T and will require 88.900 mm (3.5000 in) to be added to the T-width values. LM281048TE may be paired with all double cups corresponding to LM281031T and will require 177.800 mm (7.0000 in) to be added to the T-width values.	

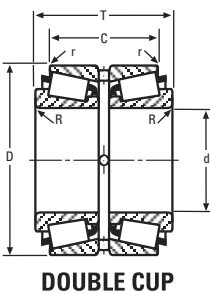
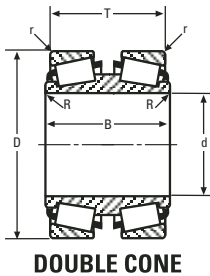
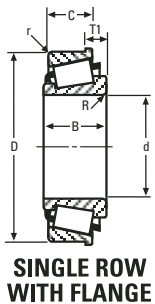
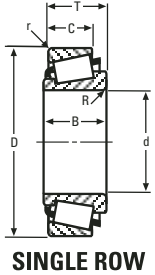



LM281000 – M281600 SERIES

CONE			Max Shaft Fillet Radii R''	Weight	CUP			Max Hs'ng Fillet Radii r''	Weight	BEAR-ING	Remarks
Number	BORE d	WIDTH B			Number	OUTSIDE DIA D	WIDTH C			WIDTH T	
<b>LM281000 Series (cont)</b>											
LM281049	646.112 25.4375	141.288 5.5625	6.4 .25	-						LM281049 may be paired with all single cups corresponding to LM281031T and will require -.419 mm (-.0165 in) to be added to the T-width values. LM281049 may be paired with all double cups corresponding to LM281031T and will require -.838 mm (-.0330 in) to be added to the T-width values.	
LM281049DW	646.112 25.4375	260.350 10.2500	3.3 .13	-						LM281049DW and grouped cones may be paired with all single cups corresponding to LM281044TD and will require 2.337 mm (.0920 in) to be added to the T-width values.	
LM281049DWH	646.112 25.4375	260.350 10.2500	3.3 .13	-							
<b>M281000 Series</b>											
M281049D	635.000 25.0000	317.500 12.5000	3.3 .13	-	M281010	901.700 35.5000	136.525 5.3750	6.4 .25	105.32 kg 232.23 lb	317.500 12.5000	
<b>L281100 Series</b>											
L281146	660.235 25.9935	95.250 3.7500	6.4 .25	70.16 kg 154.69 lb	L281110	812.800 32.0000	73.025 2.8750	6.4 .25	28.53 kg 62.90 lb	95.250 3.7500	L281148DWA: ASYMMETRICAL BEARING L281149DG: GROOVE IN ID
L281147	660.400 26.0000	95.250 3.7500	6.4 .25	-	*L281110CD	812.800 32.0000	158.750 6.2500	1.5 .06	61.80 kg 136.26 lb	203.200 8.0000	L281110CD : GROOVE IN OD CENTER HOLES IN OD CENTER
L281148	660.400 26.0000	95.250 3.7500	6.4 .25	70.03 kg 154.41 lb							
L281148AA	660.400 26.0000	95.250 3.7500	6.4 .25	69.77 kg 153.84 lb							
*L281148DWA	660.400 26.0000	182.562 7.1875	3.3 .13	162.44 kg 358.19 lb	L281110	812.800 32.0000	73.025 2.8750	6.4 .25	28.53 kg 62.90 lb	176.213 6.9375	
L281149D	660.400 26.0000	176.212 6.9375	3.3 .13	-							
*L281149DG	660.400 26.0000	176.212 6.9375	3.3 .13	-							
L281149DW	660.400 26.0000	176.212 6.9375	3.3 .13	-							
<b>M281300 Series</b>											
M281349D	649.925 25.5876	323.000 12.7165	3.5 .14	-	M281310	914.898 36.0196	138.000 5.4331	6.0 .24	105.09 kg 231.72 lb	325.000 12.7953	
<b>M281600 Series</b>											
*M281631T	624.957 24.6046	188.912 7.4375	9.7 .38	-	M281610	933.450 36.7500	141.288 5.5625	6.4 .25	116.62 kg 257.15 lb	178.727 7.0365	M281631T: REVERSE TAPERED BORE M281631TW: KEYWAY IN FRONTFACE REVERSE TAPERED BORE
*M281631TW	624.957 24.6046	188.912 7.4375	9.7 .38	-							
*M281632T	625.160 24.6126	188.912 7.4375	9.7 .38	-							M281632T: REVERSE TAPERED BORE
*M281648T	669.671 26.3650	188.912 7.4375	9.7 .38	-							M281644TD: TAPERED BORE TQ1/TQ0 (NON-INTERLOCKING)
*M281648TW	669.671 26.3650	188.912 7.4375	9.7 .38	-							M281645TD: ASYMMETRICAL BEARING TAPERED BORE
*M281644TD	654.030 25.7492	347.662 13.6875	4.8 .19	-	M281610	933.450 36.7500	141.288 5.5625	6.4 .25	116.62 kg 257.15 lb	327.292 12.8855	M281645TDW: TAPERED BORE
*M281645TD	653.928 25.7452	347.662 13.6875	4.8 .19	-							M281648T: TAPERED BORE
*M281645TDW	653.928 25.7452	347.662 13.6875	4.8 .19	-							M281648TE: SPECIAL BACKFACE RADIUS TAPERED BORE M281648TW: KEYWAY IN FRONTFACE TAPERED BORE M281610CD : GROOVE IN OD CENTER HOLES IN OD CENTER
M281635	635.000 25.0000	177.800 7.0000	12.0 .47	-	M281610	933.450 36.7500	141.288 5.5625	6.4 .25	116.62 kg 257.15 lb	179.387 7.0625	
					*M281610CD	933.450 36.7500	301.625 11.8750	1.5 .06	248.31 kg 547.52 lb	377.825 14.8750	
*M281648TE	675.625 26.5994	260.350 10.2500	spcl. spcl.	-							M281648TE may be paired with all single cups corresponding to M281631T and will require 71.437 mm (2.8125 in) to be added to the T-width values.

7

\*\*These Maximum Fillet Radii will be cleared by the Cone or Cup Radii.  
†Bore or O.D. shown are maximum dimensions. \*See Remarks Column.

**M281600 – M283400 SERIES**

CONE			Max Shaft Fillet Radii R <sup>**</sup>	Weight	CUP			Max Hs'ng Fillet Radii r <sup>**</sup>	Weight	BEARING	Remarks
Number	BORE d	WIDTH B			Number	OUTSIDE DIA D	WIDTH C			WIDTH T	
<b>M281600 Series (cont)</b>											
M281649D	657.225 25.8750	328.612 12.9375	3.3 .13	-	M281649D and grouped cones may be paired with all single cups corresponding to M281631T and will require 1.321 mm (.0520 in) to be added to the T-width values.						
M281649DW	657.225 25.8750	328.612 12.9375	3.3 .13	-							
<b>LM281800 Series</b>											
LM281849	679.450 26.7500	142.875 5.6250	9.7 .38	-	LM281810	901.700 35.5000	111.125 4.3750	6.4 .25	70.74 kg 155.98 lb	142.875 5.6250	LM281810CD : GROOVE IN OD CENTER HOLES IN OD CENTER
					*LM281810D	901.700 35.5000	244.475 9.6250	1.5 .06	154.23 kg 340.07 lb	307.975 12.1250	LM281810D : GROOVE IN OD CENTER HOLES IN OD CENTER
					*LM281810CD	901.700 35.5000	244.475 9.6250	1.5 .06	153.88 kg 339.30 lb	307.975 12.1250	
LM281849DW	679.450 26.7500	265.112 10.4375	3.3 .13	-	LM281810	901.700 35.5000	111.125 4.3750	6.4 .25	70.74 kg 155.98 lb	265.113 10.4375	
<b>M282200 Series</b>											
*M282247	682.625 26.8750	185.738 7.3125	9.7 .38	-	M282210	965.200 38.0000	142.875 5.6250	6.4 .25	124.98 kg 275.59 lb	185.737 7.3125	M282247: HOLES IN BACKFACE M282249D: SHOULDER ON OD LEFTFACE
M282249	682.625 26.8750	185.738 7.3125	9.7 .38	-	*M282210CD	965.200 38.0000	311.150 12.2500	1.5 .06	276.33 kg 609.32 lb	396.875 15.6250	M282210CD : GROOVE IN OD CENTER HOLES IN OD CENTER
					*M282211	965.200 38.0000	142.875 5.6250	6.4 .25	125.18 kg 276.02 lb	185.737 7.3125	M282211 : HOLES IN BACKFACE
*M282249D	682.625 26.8750	338.138 13.3125	3.3 .13	-	M282210	965.200 38.0000	142.875 5.6250	6.4 .25	124.98 kg 275.59 lb	338.138 13.3125	
					*M282211	965.200 38.0000	142.875 5.6250	6.4 .25	125.18 kg 276.02 lb	338.138 13.3125	
<b>LM282500 Series</b>											
LM282548X	708.025 27.8750	146.050 5.7500	6.4 .25	174.69 kg 385.20 lb	LM282510	930.275 36.6250	115.888 4.5625	6.4 .25	74.83 kg 165.00 lb	146.050 5.7500	LM282534: HOLES IN BACKFACE LM282510D : GROOVE IN OD CENTER HOLES IN OD CENTER
					*LM282510D	930.275 36.6250	250.825 9.8750	3.3 .13	163.81 kg 361.20 lb	311.150 12.2500	
					*LM282519	999.900 39.3661	119.062 4.6875	6.4 .25	176.68 kg 389.57 lb	149.225 5.8750	LM282519 : HOLES IN BACKFACE
LM282549D	708.025 27.8750	273.050 10.7500	3.3 .13	-	LM282510	930.275 36.6250	115.888 4.5625	6.4 .25	74.83 kg 165.00 lb	273.050 10.7500	
LM282549DW	708.025 27.8750	273.050 10.7500	3.3 .13	-	*LM282519	999.900 39.3661	119.062 4.6875	6.4 .25	176.68 kg 389.57 lb	279.400 11.0000	
LM282549DWH	708.025 27.8750	273.050 10.7500	3.3 .13	-							
*LM282534	660.400 26.0000	152.400 6.0000	6.4 .25	-	LM282534 may be paired with all single cups corresponding to LM282548X and will require 3.175 mm (.1250 in) to be added to the T-width values. LM282534 may be paired with all double cups corresponding to LM282548X and will require 6.350 mm (.2500 in) to be added to the T-width values.						
<b>LM282800 Series</b>											
LM282847DW	717.550 28.2500	273.050 10.7500	3.3 .13	-	LM282810	946.150 37.2500	115.888 4.5625	6.4 .25	79.08 kg 174.37 lb	273.050 10.7500	
<b>M283400 Series</b>											
*M283430T	694.400 27.3386	211.138 8.3125	9.7 .38	-	M283410	1035.050 40.7500	155.575 6.1250	6.4 .25	157.07 kg 346.34 lb	197.841 7.7890	M283430T: REVERSE TAPERED BORE M283433: HOLES IN BACKFACE
*M283449T	744.538 29.3125	211.138 8.3125	9.7 .38	-	*M283419	1079.900 42.5157	158.000 6.2205	12.0 .47	252.15 kg 555.99 lb	199.402 7.8505	M283446TD: TAPERED BORE TQI/TQO (NON-INTERLOCKING)
*M283449D	730.250 28.7500	365.125 14.3750	3.3 .13	-	M283410	1035.050 40.7500	155.575 6.1250	6.4 .25	157.07 kg 346.34 lb	365.126 14.3750	M283449D: SHOULDER ON OD RIGHTFACE
*M283449DW	730.250 28.7500	365.125 14.3750	3.3 .13	-	*M283419	1079.900 42.5157	158.000 6.2205	12.0 .47	252.15 kg 555.99 lb	368.248 14.4980	M283449DW: SHOULDER ON OD RIGHTFACE SLOTS IN LEFTFACE M283449T: TAPERED BORE M283410D : GROOVE IN OD CENTER HOLES IN OD CENTER M283419 : HOLES IN BACKFACE

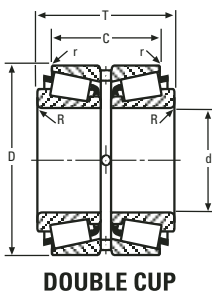
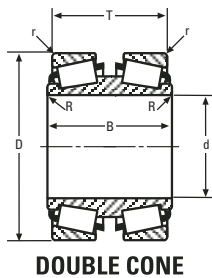
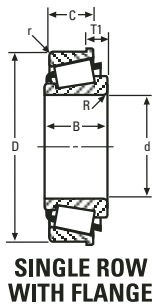
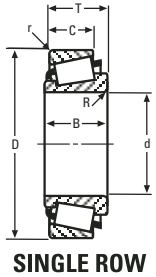

M283400 SERIES CONTINUED ON NEXT PAGE

\*\*These Maximum Fillet Radii will be cleared by the Cone or Cup Radii.  
†Bore or O.D. shown are maximum dimensions. \*See Remarks Column.

M283400 – M284200 SERIES

CONE			Max Shaft Fillet Radii R <sup>1</sup>	Weight	CUP			Max Hs'ng Fillet Radii r <sup>1</sup>	Weight	BEAR-ING	Remarks
Number	BORE d	WIDTH B			Number	OUTSIDE DIA D	WIDTH C			WIDTH T	
<b>M283400 Series (cont)</b>											
*M283433	682.625 26.8750	200.000 7.8740	12.0 .47	-	M283410	1035.050 40.7500	155.575 6.1250	6.4 .25	157.07 kg 346.34 lb	198.438 7.8125	
					*M283410D	1035.050 40.7500	336.550 13.2500	1.5 .06	349.12 kg 769.82 lb	422.275 16.6250	
					*M283419	1079.900 42.5157	158.000 6.2205	12.0 .47	252.15 kg 555.99 lb	200.000 7.8740	
*M283446TD	726.943 28.6198	365.125 14.3750	4.8 .19	-	M283446TD may be paired with all single cups corresponding to M283430T and will require -1.194 mm (-.0470 in) to be added to the T-width values.						
<b>LM283600 Series</b>											
*LM283630T	709.216 27.9219	169.000 6.6535	6.4 .25	-	LM283610	990.600 39.0000	123.000 4.8425	6.4 .25	94.27 kg 207.87 lb	158.432 6.2375	LM283630T: REVERSE TAPERED BORE
*LM283649T	749.300 29.5000	169.000 6.6535	6.4 .25	-							LM283645TD: TAPERED BORE TQI/TQO (NON-INTERLOCKING)
											LM283649T: TAPERED BORE
*LM283645TD	735.216 28.9455	312.003 12.2836	3.3 .13	-	LM283610	990.600 39.0000	123.000 4.8425	6.4 .25	94.27 kg 207.87 lb	290.865 11.4514	LM283610CD : GROOVE IN OD CENTER HOLES IN OD CENTER
LM283649	749.300 29.5000	160.338 6.3125	6.4 .25	-	LM283610	990.600 39.0000	123.000 4.8425	6.4 .25	94.27 kg 207.87 lb	159.500 6.2795	
					*LM283610CD	990.600 39.0000	265.000 10.4331	3.3 .13	203.58 kg 448.90 lb	338.000 13.3071	
LM283649DW	749.300 29.5000	293.000 11.5354	3.3 .13	-	LM283649DW may be paired with all single cups corresponding to LM283630T and will require 2.134 mm (.0840 in) to be added to the T-width values.						
<b>M284100 Series</b>											
M284148DW	762.000 30.0000	352.425 13.8750	9.3 .36	-	M284111	1066.800 42.0000	155.575 6.1250	12.7 .50	161.98 kg 357.17 lb	365.125 14.3750	
<b>M284200 Series</b>											
*M284229T	725.548 28.5649	219.075 8.6250	9.7 .38	-	M284210	1079.500 42.5000	161.925 6.3750	12.7 .50	177.36 kg 391.08 lb	205.714 8.0990	M284229T: REVERSE TAPERED BORE
											M284230T: REVERSE TAPERED BORE
*M284230T	725.752 28.5729	219.075 8.6250	9.7 .38	-							M284230TL: EXTENDED SMALL RIB KEYWAY IN FRONTFACE REVERSE TAPERED BORE
*M284230TW	725.752 28.5729	219.075 8.6250	9.7 .38	-							SHOULDER ON ID FRONTFACE
*M284232T	725.955 28.5809	219.075 8.6250	9.7 .38	-							M284230TW: KEYWAY IN FRONTFACE REVERSE TAPERED BORE
*M284248T	777.672 30.6170	219.075 8.6250	9.7 .38	-							M284232T: REVERSE TAPERED BORE
*M284249T	777.875 30.6250	219.075 8.6250	9.7 .38	-							M284244TD: TAPERED BORE TQI/TQO (NON-INTERLOCKING)
*M284249TW	777.875 30.6250	219.075 8.6250	9.7 .38	-							M284245TDL: EXTENDED SMALL RIB TAPERED BORE TQI/TQO (INTERLOCKING)
*M284244TD	759.414 29.8982	406.400 16.0000	4.8 .19	-	M284210	1079.500 42.5000	161.925 6.3750	12.7 .50	177.36 kg 391.08 lb	379.678 14.9480	M284245TDW: TAPERED BORE
*M284245TDW	759.618 29.9062	406.400 16.0000	4.8 .19	-							TQI/TQO (NON-INTERLOCKING)
*M284246TD	759.618 29.9062	406.400 16.0000	4.8 .19	-							M284246TD: TAPERED BORE TQI/TQO (NON-INTERLOCKING)
*M284247TD	759.744 29.9112	406.400 16.0000	4.8 .19	-							M284247TD: TAPERED BORE TQI/TQO (NON-INTERLOCKING)
											M284248T: TAPERED BORE
											M284249D: SHOULDER ON OD LEFTFACE
											M284249DW: SHOULDER ON OD LEFTFACE
											M284249T: TAPERED BORE
											M284249TL: EXTENDED SMALL RIB KEYWAY IN FRONTFACE SHOULDER ON ID FRONTFACE TAPERED BORE

7

<sup>1</sup>These Maximum Fillet Radii will be cleared by the Cone or Cup Radii.  
<sup>†</sup>Bore or O.D. shown are maximum dimensions. \*See Remarks Column.

M284200 – LM286200 SERIES

CONE			Max Shaft Fillet Radii R <sup>**</sup>	Weight	CUP			Max Hs'ng Fillet Radii r <sup>**</sup>	Weight	BEARING	Remarks
Number	BORE d	WIDTH B			Number	OUTSIDE DIA D	WIDTH C			WIDTH T	
<b>M284200 Series (cont)</b>											
*M284230TL	724.827 28.5365	207.962 8.1875	10.0 .39	-	M284210	1079.500 42.5000	161.925 6.3750	12.7 .50	177.36 kg 391.08 lb	206.375 8.1250	M284249TW: KEYWAY IN FRONTFACE TAPERED BORE M284210D: GROOVE IN OD CENTER HOLES IN OD CENTER
*M284249TL	777.875 30.6250	207.962 8.1875	10.0 .39	-	*M284210D	1079.500 42.5000	349.250 13.7500	3.3 .13	395.78 kg 872.69 lb	438.149 17.2500	
*M284245TDL	760.545 29.9427	428.625 16.8750	5.0 .20	-	M284245TDL and grouped cones may be paired with all single cups corresponding to M284229T and will require 1.321 mm (.0520 in) to be added to the T-width values.						
*M284249D	762.000 30.0000	381.000 15.0000	4.8 .19	-							
*M284249DW	762.000 30.0000	381.000 15.0000	4.8 .19	-							
<b>285000 Series</b>											
EE285160	406.400 16.0000	67.866 2.6719	6.8 .27	34.23 kg 75.49 lb	285226	574.675 22.6250	50.800 2.0000	3.3 .13	18.97 kg 41.84 lb	76.20 3.0000	285228D: GROOVE IN OD CENTER HOLES IN OD CENTER
EE285162	409.575 16.1250	67.866 2.6719	6.8 .27	33.15 kg 73.10 lb	*285228DC	574.675 22.6250	106.362 4.1875	1.5 .06	39.07 kg 86.16 lb	157.162 6.1875	285228DC: HOLES IN OD CENTER
					*285228D	574.675 22.6250	106.362 4.1875	1.5 .06	39.07 kg 86.16 lb	157.162 6.1875	
NA285160	406.400 16.0000	78.583 3.0938	6.4 .25	-	*285228DC	574.675 22.6250	106.362 4.1875	1.5 .06	39.07 kg 86.16 lb	157.165 6.1876	
					*285228D	574.675 22.6250	106.362 4.1875	1.5 .06	39.07 kg 86.16 lb	157.165 6.1876	
EE285161D	406.400 16.0000	114.300 4.5000	3.3 .13	79.42 kg 175.12 lb	285226	574.675 22.6250	50.800 2.0000	3.3 .13	18.97 kg 41.84 lb	130.967 5.1562	
<b>LM285700 Series</b>											
*LM285730TL	795.782 31.3300	168.275 6.6250	9.7 .38	-	LM285710	1143.000 45.0000	127.000 5.0000	9.7 .38	139.95 kg 308.58 lb	173.038 6.8125	LM285730TL: KEYWAY IN FRONTFACE REVERSE TAPERED BORE SHOULDER ON ID FRONTFACE
*LM285749TL	838.200 33.0000	168.275 6.6250	9.7 .38	-							LM285746TDE: TAPERED BORE TQI/TQO (NON-INTERLOCKING)
*LM285746TDE	824.177 32.4479	374.650 14.7500	5.0 .20	-	LM285710	1143.000 45.0000	127.000 5.0000	9.7 .38	139.95 kg 308.58 lb	314.326 12.3750	LM285746TDL: TAPERED BORE TQI/TQO (INTERLOCKING)
*LM285746TDL	824.177 32.4479	374.650 14.7500	5.0 .20	-							LM285749TL: KEYWAY IN FRONTFACE SHOULDER ON ID FRONTFACE TAPERED BORE
<b>M285800 Series</b>											
M285848D	825.500 32.5000	409.575 16.1250	4.8 .19	-	M285810	1168.400 46.0000	177.800 7.0000	12.7 .50	224.74 kg 495.56 lb	409.574 16.1250	M285848D GW: GROOVE IN ID
*M285848D GW	825.500 32.5000	409.575 16.1250	4.8 .19	-							
M285848DW	825.500 32.5000	409.575 16.1250	4.8 .19	-							
<b>LM286200 Series</b>											
*LM286230TL	818.358 32.2188	174.625 6.8750	9.7 .38	-	LM286210	1130.300 44.5000	138.112 5.4375	12.7 .50	131.55 kg 290.06 lb	174.625 6.8750	LM286230T: REVERSE TAPERED BORE
LM286249	863.600 34.0000	185.738 7.3125	9.7 .38	-	*LM286210CD	1130.300 44.5000	298.450 11.7500	3.3 .13	282.28 kg 622.42 lb	371.475 14.6250	LM286230TL: EXTENDED SMALL RIB KEYWAY IN FRONTFACE REVERSE TAPERED BORE SHOULDER ON ID FRONTFACE
LM286249AA	863.600 34.0000	174.625 6.8750	9.7 .38	-	*LM286210DV	1130.300 44.5000	298.450 11.7500	3.3 .13	282.63 kg 623.20 lb	371.475 14.6250	
*LM286249TL	863.600 34.0000	174.625 6.8750	9.7 .38	-	*LM286210V	1130.300 44.5000	138.112 5.4375	12.7 .50	131.55 kg 290.06 lb	174.625 6.8750	LM286246TD: TAPERED BORE TQI/TQO (NON-INTERLOCKING)
					*LM286210X	1130.300 44.5000	138.112 5.4375	12.7 .50	131.55 kg 290.06 lb	174.625 6.8750	
					LM286211V	1130.300 44.5000	138.112 5.4375	12.7 .50	131.55 kg 290.06 lb	174.625 6.8750	LM286246TDL: EXTENDED SMALL RIB TAPERED BORE TQI/TQO (INTERLOCKING)
					LM286215	1143.000 45.0000	138.112 5.4375	12.7 .50	153.47 kg 338.40 lb	174.625 6.8750	
					*LM286215E	1143.000 45.0000	171.450 6.7500	12.7 .50	174.57 kg 384.92 lb	174.625 6.8750	LM286248D GW: GROOVE IN ID

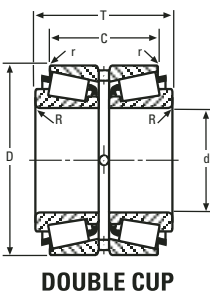
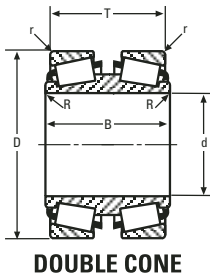
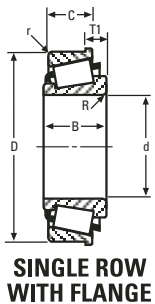
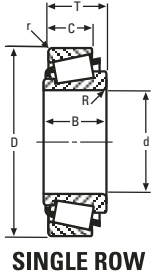

LM286200 SERIES CONTINUED ON NEXT PAGE

\*\*These Maximum Fillet Radii will be cleared by the Cone or Cup Radii.  
†Bore or O.D. shown are maximum dimensions. \*See Remarks Column.

LM286200 – LM286400 SERIES

CONE			Max Shaft Fillet Radii R''	Weight	CUP			Max Hs'ng Fillet Radii r''	Weight	BEAR-ING	Remarks
Number	BORE d	WIDTH B			Number	OUTSIDE DIA D	WIDTH C			WIDTH T	
LM286200 Series (cont)											
				*LM286219X	1165.000 45.8661	140.000 5.5118	- -	196.97 kg 434.33 lb	175.000 6.8898	LM286248TE: EXTENDED LARGE RIB SHOULDER ON ID BACKFACE TAPERED BORE LM286249ADW: HOLES IN OD CENTER	
*LM286246TDL	849.048 33.4271	368.300 14.5000	5.0 .20	- LM286210	1130.300 44.5000	138.112 5.4375	12.7 .50	131.55 kg 290.06 lb	323.850 12.7500	LM286249DA: HOLES IN OD CENTER	
*LM286248DGW	863.600 34.0000	323.850 12.7500	4.8 .19	- *LM286210V	1130.300 44.5000	138.112 5.4375	12.7 .50	131.55 kg 290.06 lb	323.850 12.7500	LM286249T: TAPERED BORE	
LM286248DW	863.600 34.0000	323.850 12.7500	4.8 .19	- *LM286210X	1130.300 44.5000	138.112 5.4375	12.7 .50	131.55 kg 290.06 lb	323.850 12.7500	LM286249TE: EXTENDED LARGE RIB	
LM286248DWV	863.600 34.0000	323.850 12.7500	4.8 .19	- LM286211V	1130.300 44.5000	138.112 5.4375	12.7 .50	131.55 kg 290.06 lb	323.850 12.7500	SPECIAL BACKFACE RADIUS TAPERED BORE	
*LM286249ADW	863.600 34.0000	323.850 12.7500	4.8 .19	- LM286215	1143.000 45.0000	138.112 5.4375	12.7 .50	153.47 kg 338.40 lb	323.850 12.7500	LM286249TL: EXTENDED SMALL RIB	
LM286249D	863.600 34.0000	323.850 12.7500	4.8 .19	- *LM286219X	1165.000 45.8661	140.000 5.5118	- -	196.97 kg 434.33 lb	324.602 12.7796	KEYWAY IN FRONTFACE SHOULDER ON ID FRONTFACE TAPERED BORE	
*LM286249DA	863.600 34.0000	323.850 12.7500	4.8 .19	-							
LM286249DW	863.600 34.0000	323.850 12.7500	4.8 .19	-						LM286249TLE: EXTENDED LARGE RIB EXTENDED SMALL RIB KEYWAY IN FRONTFACE SHOULDER ON ID FRONTFACE SPECIAL BACKFACE RADIUS TAPERED BORE	
				-						LM286210CD : GROOVE IN OD CENTER HOLES IN OD CENTER	
				-						LM286210DV : GROOVE IN OD CENTER HOLES IN OD CENTER	
				-						LM286210V : GROOVE IN OD BACKFACE	
				-						LM286210X : GROOVE IN OD BACKFACE	
				-						LM286215E : SHOULDER ON ID FRONTFACE	
				-						LM286219X : CHAMFER ON BACKFACE OD SHOULDER ON OD BACKFACE	
*LM286230T	819.282 32.2552	185.738 7.3125	9.7 .38	- LM286210	1130.300 44.5000	138.112 5.4375	12.7 .50	131.55 kg 290.06 lb	173.965 6.8490		
*LM286249T	863.600 34.0000	185.738 7.3125	9.7 .38	- *LM286210V	1130.300 44.5000	138.112 5.4375	12.7 .50	131.55 kg 290.06 lb	173.965 6.8490		
				-	*LM286210X	1130.300 44.5000	138.112 5.4375	12.7 .50	131.55 kg 290.06 lb	173.965 6.8490	
				-	LM286211V	1130.300 44.5000	138.112 5.4375	12.7 .50	131.55 kg 290.06 lb	173.965 6.8490	
				-	LM286215	1143.000 45.0000	138.112 5.4375	12.7 .50	153.47 kg 338.40 lb	173.965 6.8490	
				-	*LM286215E	1143.000 45.0000	171.450 6.7500	12.7 .50	174.57 kg 384.92 lb	173.965 6.8490	
				-	*LM286219X	1165.000 45.8661	140.000 5.5118	- -	196.97 kg 434.33 lb	174.341 6.8638	
*LM286246TD	848.121 33.3906	346.075 13.6250	4.8 .19	-						LM286246TD may be paired with all single cups corresponding to LM286246TDL and will require -1.321 mm (-.0520 in) to be added to the T-width values.	
*LM286248TE	872.597 34.3542	293.688 11.5625	56.0 2.20	-						LM286248TE may be paired with all single cups corresponding to LM286230T and will require 107.950 mm (4.2500 in) to be added to the T-width values.	
*LM286249TE	870.346 34.2656	266.700 10.5000	spcl. spcl.	-						LM286249TE may be paired with all single cups corresponding to LM286230T and will require 80.962 mm (3.1875 in) to be added to the T-width values.	
*LM286249TLE	872.597 34.3542	303.784 11.9600	spcl. spcl.	-						LM286249TLE may be paired with all single cups corresponding to LM286230T and will require 108.610 mm (4.2760 in) to be added to the T-width values.	
LM286400 Series											
*LM286429T	828.919 32.6346	185.738 7.3125	9.7 .38	- LM286410	1181.100 46.5000	133.350 5.2500	12.7 .50	147.51 kg 325.27 lb	175.451 6.9075	LM286429T: REVERSE TAPERED BORE	
*LM286433T	828.716 32.6266	185.738 7.3125	9.7 .38	- *LM286411	1181.049 46.4980	133.350 5.2500	12.7 .50	151.08 kg 333.14 lb	175.451 6.9075	LM286432TL: KEYWAY IN FRONTFACE REVERSE TAPERED BORE SHOULDER ON ID FRONTFACE	

7

\*\*These Maximum Fillet Radii will be cleared by the Cone or Cup Radii.  
†Bore or O.D. shown are maximum dimensions. \*See Remarks Column.

**LM286400 – LM287800 SERIES**

CONE			Max Shaft Fillet Radii R <sup>**</sup>	Weight	CUP			Max H's'ng Fillet Radii r <sup>**</sup>	Weight	BEARING	Remarks
Number	BORE d	WIDTH B			Number	OUTSIDE DIA D	WIDTH C			WIDTH T	
LM286400 Series (cont)											
*LM286447T	872.769 34.3610	185.738 7.3125	9.7 .38	-	-	-	-	-	-	LM286433T: REVERSE TAPERED BORE	
*LM286432TL	827.527 32.5798	171.450 6.7500	9.7 .38	-	LM286410	1181.100 46.5000	133.350 5.2500	12.7 .50	147.51 kg 325.27 lb	175.451 6.9075	LM286443TD: TAPERED BORE TQI/TQO (NON-INTERLOCKING)
*LM286448TL	872.769 34.3610	171.450 6.7500	9.7 .38	-	*LM286410D	1181.100 46.5000	285.750 11.2500	3.3 .13	308.65 kg 680.58 lb	369.952 14.5650	LM286444TD: TAPERED BORE TQI/TQO (NON-INTERLOCKING)
					*LM286411	1181.049 46.4980	133.350 5.2500	12.7 .50	151.08 kg 333.14 lb	175.451 6.9075	LM286445TDL: TAPERED BORE TQI/TQO (INTERLOCKING)
					*LM286411D	1181.049 46.4980	285.750 11.2500	3.3 .13	308.38 kg 679.97 lb	369.952 14.5650	LM286445TDL: TAPERED BORE TQI/TQO (INTERLOCKING)
											LM286447T: TAPERED BORE
*LM286443TD	857.291 33.7516	342.900 13.5000	4.8 .19	-	LM286410	1181.100 46.5000	133.350 5.2500	12.7 .50	147.51 kg 325.27 lb	322.326 12.6900	LM286448TL: KEYWAY IN FRONTFACE SHOULDER ON ID FRONTFACE TAPERED BORE
*LM286444TD	857.392 33.7556	342.900 13.5000	4.8 .19	-	*LM286411	1181.049 46.4980	133.350 5.2500	12.7 .50	151.08 kg 333.14 lb	322.326 12.6900	LM286410D : GROOVE IN OD CENTER HOLES IN OD CENTER LM286411 : GROOVE IN OD BACKFACE LM286411D : HOLES IN OD CENTER
*LM286445TDL	858.482 33.7985	371.475 14.6250	5.0 .20	-							
LM286449D	863.600 34.0000	323.850 12.7500	4.8 .19	-	LM28649D may be paired with all single cups corresponding to LM286429T and will require 1.524 mm (.0600 in) to be added to the T-width values.						
LM286700 Series											
*LM286733T	841.375 33.1250	225.425 8.8750	10.0 .39	-	*LM286710	1212.850 47.7500	168.275 6.6250	12.7 .50	207.14 kg 456.75 lb	210.947 8.3050	LM286733T: REVERSE TAPERED BORE
*LM286749T	895.350 35.2500	225.425 8.8750	10.0 .39	-	LM286711	1219.873 48.0265	168.275 6.6250	12.7 .50	224.40 kg 494.80 lb	210.947 8.3050	LM286746TD: TAPERED BORE TQI/TQO (NON-INTERLOCKING) LM286749DG: GROOVE IN ID
LM286749D	877.888 34.5625	396.875 15.6250	4.8 .19	-	*LM286710	1212.850 47.7500	168.275 6.6250	12.7 .50	207.14 kg 456.75 lb	396.875 15.6250	LM286749T: TAPERED BORE
*LM286749DG	877.888 34.5625	396.875 15.6250	4.8 .19	-	LM286711	1219.873 48.0265	168.275 6.6250	12.7 .50	224.40 kg 494.80 lb	396.875 15.6250	LM286710 : GROOVE IN OD BACKFACE
*LM286746TD	876.564 34.5104	422.275 16.6250	5.0 .20	-	LM286746TD may be paired with all single cups corresponding to LM286733T and will require -3.556 mm (-.1400 in) to be added to the T-width values.						
L286900 Series											
†JL286948	928.000 36.5354	90.000 3.5433	3.3 .13	-	†JL286910	1060.000 41.7323	76.000 2.9921	3.3 .13	35.33 kg 77.90 lb	92.000 3.6220	
†JL286948H	928.000 36.5354	90.000 3.5433	3.3 .13	85.21 kg 187.89 lb							
†JL286949	930.000 36.6142	90.000 3.5433	3.3 .13	-							
†JL286949H	930.000 36.6142	90.000 3.5433	3.3 .13	83.15 kg 183.34 lb							
LM287600 Series											
LM287649D	938.212 36.9375	400.050 15.7500	4.8 .19	-	LM287610	1270.000 50.0000	169.862 6.6875	12.7 .50	224.49 kg 495.00 lb	400.050 15.7500	LM287649DGW: GROOVE IN ID
*LM287649DGW	938.212 36.9375	400.050 15.7500	4.8 .19	-							
LM287649DW	938.212 36.9375	400.050 15.7500	4.8 .19	-							
LM287800 Series											
*LM287849AD	939.800 37.0000	463.550 18.2500	4.8 .19	-	LM287810	1333.500 52.5000	200.025 7.8750	12.7 .50	333.38 kg 735.11 lb	463.550 18.2500	LM287849AD: HOLES IN OD CENTER LM287849DA: ASYMMETRICAL BEARING
LM287849D	939.800 37.0000	463.550 18.2500	4.8 .19	-	*LM287810X	1333.500 52.5000	200.025 7.8750	12.7 .50	333.34 kg 735.02 lb	463.550 18.2500	LM287810X : HOLES IN BACKFACE
*LM287849DA	939.800 37.0000	522.287 20.5625	4.8 .19	-							
LM287849DH	939.800 37.0000	463.550 18.2500	4.8 .19	-							

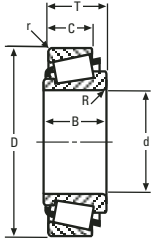

**SINGLE ROW**

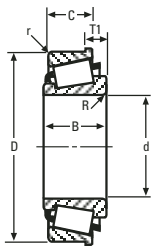

**SINGLE ROW WITH FLANGE**

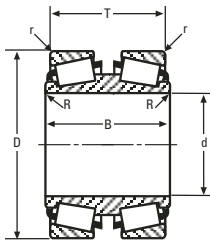

**DOUBLE CONE**

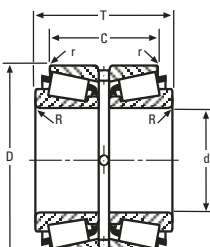

**DOUBLE CUP**

LM287800 SERIES CONTINUED ON NEXT PAGE

\*\*These Maximum Fillet Radii will be cleared by the Cone or Cup Radii.  
†Bore or O.D. shown are maximum dimensions. \*See Remarks Column.

LM287800 – 290000 SERIES

7

CONE			Max Shaft Fillet Radii R''	Weight	CUP			Max Hs'ng Fillet Radii r''	Weight	BEAR-ING	Remarks
Number	BORE d	WIDTH B			Number	OUTSIDE DIA D	WIDTH C			WIDTH T	
<b>LM287800 Series (cont)</b>											
LM287849DW	939.800 37.0000	463.550 18.2500	4.8 .19	-							
LM287849DWH	939.800 37.0000	463.550 18.2500	4.8 .19	-							
<b>LM288100 Series</b>											
*LM288130T	954.616 37.5833	209.550 8.2500	12.7 .50	-	LM288110	1308.100 51.5000	158.750 6.2500	12.7 .50	203.40 kg 448.50 lb	198.653 7.8210	LM288130T: REVERSE TAPERED BORE
*LM288132T	954.616 37.5833	209.550 8.2500	12.7 .50	-	*LM288111	1308.100 51.5000	158.750 6.2500	12.7 .50	201.68 kg 444.70 lb	198.653 7.8210	LM288132T: REVERSE TAPERED BORE
*LM288147T	1004.634 39.5525	209.550 8.2500	12.7 .50	-							LM288144TD: TAPERED BORE
*LM288148T	1004.634 39.5525	209.550 8.2500	12.7 .50	-							LM288145TD: TAPERED BORE TQI/TQO (NON-INTERLOCKING)
*LM288144TD	987.298 38.8700	393.700 15.5000	6.4 .25	-	LM288110	1308.100 51.5000	158.750 6.2500	12.7 .50	203.40 kg 448.50 lb	368.732 14.5170	LM288147T: TAPERED BORE
*LM288145TD	987.298 38.8700	393.700 15.5000	6.4 .25	-	*LM288111	1308.100 51.5000	158.750 6.2500	12.7 .50	201.68 kg 444.70 lb	368.732 14.5170	LM288148T: TAPERED BORE
*LM288148TE	1013.630 39.9067	317.500 12.5000	spcl. spcl.	-	LM288148TE may be paired with all single cups corresponding to LM288130T and will require 107.950 mm (4.2500 in) to be added to the T-width values.						LM288148TE: EXTENDED LARGE RIB SPECIAL BACKFACE RADIUS TAPERED BORE
<b>LM288200 Series</b>											
LM288249D	1006.475 39.6250	368.998 14.5275	4.8 .19	-	LM288210	1295.400 51.0000	156.000 6.1417	12.7 .50	189.15 kg 417.07 lb	368.998 14.5275	
<b>LM288400 Series</b>											
*†JLM288449DG	1070.000 42.1260	430.000 16.9291	5.0 .20	-	†JLM288410	1400.000 55.1181	190.000 7.4803	13.0 .51	283.92 kg 626.04 lb	430.000 16.9291	JLM288449DG: GROOVE IN ID
†JLM288449DW	1070.000 42.1260	430.000 16.9291	5.0 .20	-							
<b>LM288900 Series</b>											
LM288949D	1200.150 47.2500	482.600 19.0000	4.8 .19	-	LM288910	1593.850 62.7500	203.200 8.0000	12.7 .50	396.17 kg 873.55 lb	482.583 18.9993	
<b>L289400 Series</b>											
*L289449DA	1499.873 59.0501	592.500 23.3268	7.0 .28	-	L289410	1914.873 75.3887	235.000 9.2520	13.0 .51	602.97 kg 1329.54 lb	540.000 21.2599	L289449DA: ASYMMETRICAL BEARING
<b>290000 Series</b>											
EE291175	298.450 11.7500	61.912 2.4375	8.0 .31	21.47 kg 47.34 lb	291749	444.500 17.5000	39.688 1.5625	3.3 .13	8.37 kg 18.46 lb	63.500 2.5000	291750-B : FLANGE ON OD FRONTFACE, BEARING WIDTH IS T1 DIMENSION
EE291201	304.800 12.0000	61.912 2.4375	8.0 .31	20.01 kg 44.12 lb	291750	444.500 17.5000	39.688 1.5625	1.5 .06	8.42 kg 18.56 lb	63.500 2.5000	291751CD : GROOVE IN OD CENTER HOLES IN OD CENTER
EE291250	317.500 12.5000	61.912 2.4375	8.0 .31	16.99 kg 37.47 lb	*291750-B	444.500 17.5000	39.688 1.5625	1.5 .06	9.42 kg 20.78 lb	36.512 1.4375	291751D : GROOVE IN OD CENTER HOLES IN OD CENTER
EE291251	317.500 12.5000	61.912 2.4375	15.0 .59	16.34 kg 36.02 lb	*291751CD	444.500 17.5000	98.425 3.8750	1.5 .06	20.66 kg 45.55 lb	146.050 5.7500	291751DC : HOLES IN OD CENTER
					*291751D	444.500 17.5000	98.425 3.8750	1.5 .06	22.16 kg 48.87 lb	146.050 5.7500	
					*291751DC	444.500 17.5000	98.425 3.8750	1.5 .06	22.16 kg 48.87 lb	146.050 5.7500	
EE291176D	298.450 11.7500	107.950 4.2500	8.0 .31	46.94 kg 103.50 lb	291749	444.500 17.5000	39.688 1.5625	3.3 .13	8.37 kg 18.46 lb	111.125 4.3750	
EE291200D	304.800 12.0000	107.950 4.2500	8.0 .31	44.40 kg 97.89 lb	291750	444.500 17.5000	39.688 1.5625	1.5 .06	8.42 kg 18.56 lb	111.125 4.3750	
EE291202D	304.800 12.0000	117.475 4.6250	8.0 .31	45.02 kg 99.26 lb							
NA291201	304.800 12.0000	69.850 2.7500	6.4 .25	42.01 kg 92.64 lb	*291751CD	444.500 17.5000	98.425 3.8750	1.5 .06	20.66 kg 45.55 lb	139.700 5.5000	
					*291751D	444.500 17.5000	98.425 3.8750	1.5 .06	22.16 kg 48.87 lb	139.700 5.5000	
					*291751DC	444.500 17.5000	98.425 3.8750	1.5 .06	22.16 kg 48.87 lb	139.700 5.5000	

\*\*These Maximum Fillet Radii will be cleared by the Cone or Cup Radii.  
†Bore or O.D. shown are maximum dimensions. \*See Remarks Column.

292000 – 299000 SERIES

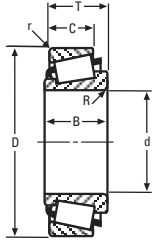

SINGLE ROW

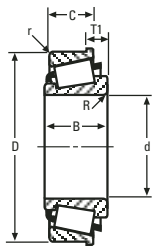

SINGLE ROW WITH FLANGE

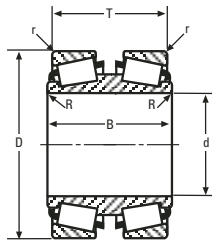

DOUBLE CONE

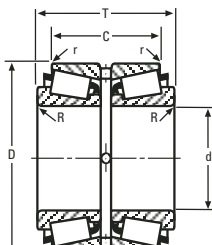

DOUBLE CUP

CONE			Max Shaft Fillet Radii R <sup>**</sup>	Weight	CUP			Max Shaft Fillet Radii r <sup>**</sup>	Weight	BEARING	Remarks
Number	BORE d	WIDTH B			Number	OUTSIDE DIA D	WIDTH C			WIDTH T	
<b>292000 Series</b>											
EE292548	1395.603 54.9450	117.475 4.6250	6.0 .24	-	*292668D	1697.038 66.8125	190.500 7.5000	3.3 .13	331.96 kg 731.98 lb	260.350 10.2500	292668D : GROOVE IN OD CENTER HOLES IN OD CENTER
EE292550	1397.000 55.0000	117.475 4.6250	6.0 .24	-							
<b>295000 Series</b>											
EE295102	260.350 10.2500	120.650 4.7500	6.4 .25	-	*295192DC	488.950 19.2500	196.850 7.7500	1.5 .06	64.90 kg 143.10 lb	254.000 10.0000	295192D : GROOVE IN OD CENTER HOLES IN OD CENTER
EE295110	279.400 11.0000	120.650 4.7500	1.3 .05	-	*295192D	488.950 19.2500	196.850 7.7500	1.5 .06	64.90 kg 143.10 lb	254.000 10.0000	295192DC : HOLES IN OD CENTER
EE295950	241.300 9.5000	120.650 4.7500	6.4 .25	-	295193	488.950 19.2500	92.075 3.6250	6.4 .25	29.79 kg 65.68 lb	120.650 4.7500	
EE295106D	266.700 10.5000	238.125 9.3750	6.4 .25	-	295193	488.950 19.2500	92.075 3.6250	6.4 .25	29.79 kg 65.68 lb	228.600 9.0000	
<b>296000 Series</b>											
EE296110	279.400 11.0000	120.650 4.7500	1.3 .05	-	296204	520.700 20.5000	92.075 3.6250	6.4 .25	35.52 kg 78.33 lb	120.650 4.7500	EE296116: EXTENDED LARGE RIB GROOVE IN OD BACKFACE SHOULDER ON OD BACKFACE
EE296112	285.750 11.2500	120.650 4.7500	1.3 .05	-	296205	520.700 20.5000	92.075 3.6250	6.4 .25	35.52 kg 78.32 lb	120.522 4.7450	
EE296115	292.100 11.5000	114.300 4.5000	1.3 .05	-	EE296115 may be paired with all single cups corresponding to EE296110 and will require -6.350 mm (-.2500 in) to be added to the T-width values.						
*EE296116	292.100 11.5000	174.625 6.8750	1.5 .06	-	EE296116 may be paired with all single cups corresponding to EE296110 and will require 53.975 mm (2.1250 in) to be added to the T-width values.						
<b>298000 Series</b>											
EE298128	320.675 12.6250	114.300 4.5000	1.3 .05	-	298216	546.100 21.5000	92.075 3.6250	6.4 .25	37.78 kg 83.31 lb	114.300 4.5000	
<b>299000 Series</b>											
EE299615	1562.100 61.5000	123.825 4.8750	9.7 .38	-	299711	1806.575 71.1250	85.725 3.3750	9.7 .38	139.70 kg 308.05 lb	127.000 5.0000	



LM300800 – HM321200 SERIES

CONE			Max Shaft Fillet Radii R''	Weight	CUP			Max Hs'ng Fillet Radii r''	Weight	BEAR-ING	Remarks
Number	BORE d	WIDTH B			Number	OUTSIDE DIA D	WIDTH C			WIDTH T	
<b>LM300800 Series</b>											
LM300848	41.275 1.6250	18.000 .7087	3.5 .14	.16 kg .35 lb	LM300811P	67.975 2.6762	13.500 .5315	1.5 .06	.08 kg .18 lb	17.500 .6890	LM300849: SPECIAL BACKFACE RADIUS
LM300848P	41.275 1.6250	18.000 .7087	3.5 .14	.16 kg .35 lb	LM300811	67.975 2.6762	13.500 .5315	1.5 .06	.08 kg .18 lb	17.500 .6890	
*LM300849	40.988 1.6137	18.000 .7087	spcl. spcl.	.16 kg .36 lb	†JLM300816	78.000 3.0709	13.500 .5315	.5 .01	.20 kg .45 lb	17.500 .6890	
<b>LM300800C Series</b>											
*LM300849C	42.987 1.6924	17.500 .6890	spcl. spcl.	.14 kg .30 lb	LM300811	67.975 2.6762	13.500 .5315	1.5 .06	.08 kg .18 lb	17.502 .6891	LM300849C: SPECIAL BACKFACE RADIUS
<b>L305600 Series</b>											
L305648	49.987 1.9680	18.258 .7188	1.5 .06	.24 kg .54 lb	*L305610-B	80.962 3.1875	14.288 .5625	1.5 .06	.14 kg .30 lb	7.145 .2813	L305610-B : FLANGE ON OD FRONTFACE, BEARING WIDTH IS T1 DIMENSION
L305649	50.800 2.0000	18.258 .7188	1.5 .06	.24 kg .52 lb	L305610	80.962 3.1875	14.288 .5625	1.5 .06	.12 kg .26 lb	18.257 .7188	
											L305610D : GROOVE IN OD CENTER HOLES IN OD CENTER
											L305613DE : GROOVE IN OD CENTER HOLES IN OD CENTER
*L305649DE	50.800 2.0000	42.862 1.6875	1.5 .06	.62 kg 1.38 lb	L305610	80.962 3.1875	14.288 .5625	1.5 .06	.12 kg .26 lb	36.512 1.4375	
											L305611 : 36.512 1.4375
											L305613 : 36.512 1.4375
<b>H307700 Series</b>											
†JH307749	55.000 2.1654	39.000 1.5354	3.0 .12	1.14 kg 2.50 lb	†JH307710	110.000 4.3307	32.000 1.2598	2.5 .10	.57 kg 1.25 lb	39.000 1.5354	
†JH307748	55.000 2.1654	44.000 1.7323	3.0 .12	1.29 kg 2.83 lb	JH307748 may be paired with all single cups corresponding to JH307749 and will require 2.002 mm (.0788 in) to be added to the T-width values.						
<b>HM318400 Series</b>											
†JHM318448	90.000 3.5433	44.000 1.7323	3.0 .12	2.30 kg 5.08 lb	†JHM318410	155.000 6.1024	35.500 1.3976	2.5 .10	1.00 kg 2.22 lb	44.000 1.7323	
†JHM318448A	90.000 3.5433	44.000 1.7323	6.0 .24	2.27 kg 5.02 lb							
<b>L319200 Series</b>											
L319245	92.075 3.6250	21.433 .8438	3.5 .14	.61 kg 1.35 lb	L319210	130.175 5.1250	16.670 .6563	1.5 .06	.24 kg .54 lb	20.638 .8125	L319210D : GROOVE IN OD CENTER HOLES IN OD CENTER
L319249	95.250 3.7500	21.433 .8438	1.5 .06	.55 kg 1.21 lb	*L319210D	130.175 5.1250	39.688 1.5625	.8 .03	.61 kg 1.35 lb	47.623 1.8749	
<b>LL319300 Series</b>											
*LL319348	95.250 3.7500	15.083 .5938	1.5 .06	- -	LL319310	128.587 5.0625	11.908 .4688	1.5 .06	.15 kg .34 lb	15.875 .6250	LL319348: BROKEN FRONTFACE ID
*LL319349	95.250 3.7500	15.083 .5938	1.5 .06	.38 kg .84 lb							
<b>321000 Series</b>											
EE321145	368.300 14.5000	139.700 5.5000	8.0 .31	- -	321240	609.600 24.0000	111.125 4.3750	6.4 .25	50.83 kg 112.09 lb	142.875 5.6250	
					321245	622.300 24.5000	111.125 4.3750	6.4 .25	61.50 kg 135.62 lb	142.875 5.6250	
EE321146D	368.300 14.5000	279.400 11.0000	3.3 .13	- -	321240	609.600 24.0000	111.125 4.3750	6.4 .25	50.83 kg 112.09 lb	254.000 10.0000	
					321245	622.300 24.5000	111.125 4.3750	6.4 .25	61.50 kg 135.62 lb	254.000 10.0000	
<b>HM321200 Series</b>											
HM321245	99.212 3.9060	49.212 1.9375	3.5 .14	3.18 kg 7.01 lb	HM321210	171.450 6.7500	38.100 1.5000	3.3 .13	1.38 kg 3.04 lb	49.213 1.9375	

†These Maximum Fillet Radii will be cleared by the Cone or Cup Radii.  
†Bore or O.D. shown are maximum dimensions. \*See Remarks Column.

323000 – LM328400 SERIES

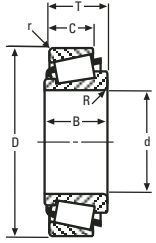

SINGLE ROW

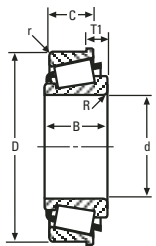

SINGLE ROW WITH FLANGE

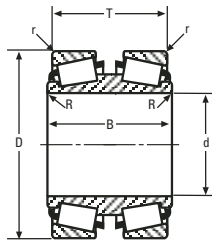

DOUBLE CONE

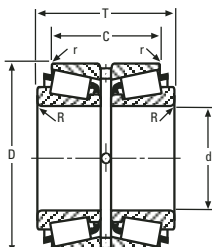

DOUBLE CUP

CONE			Max Shaft Fillet Radii R <sup>**</sup>	Weight	CUP			Max Hs'ng Fillet Radii r <sup>**</sup>	Weight	BEARING WIDTH T	Remarks
Number	BORE d	WIDTH B			Number	OUTSIDE DIA D	WIDTH C				
<b>323000 Series</b>											
*EE323166D	419.227 16.5050	406.400 16.0000	6.4 .25	- -	323290	736.448 28.9940	177.800 7.0000	6.4 .25	135.79 kg 299.43 lb	406.400 16.0000	EE323166D: HOLES IN OD CENTER
<b>324000 Series</b>											
EE324103D	260.350 10.2500	152.400 6.0000	6.4 .25	59.78 kg 131.81 lb	324160	406.400 16.0000	66.675 2.6250	3.3 .13	13.00 kg 28.66 lb	155.575 6.1250	
<b>325000 Series</b>											
EE325296D	749.300 29.5000	349.250 13.7500	9.3 .36	- -	325420	1066.800 42.0000	152.400 6.0000	12.7 .50	158.80 kg 350.14 lb	361.951 14.2500	EE325296DGW: GROOVE IN ID
*EE325296DGW	749.300 29.5000	349.250 13.7500	9.3 .36	- -							
<b>M325900 Series</b>											
M325948	127.000 5.0000	42.862 1.6875	3.5 .14	- -	*M325911	173.038 6.8125	39.688 1.5625	3.3 .13	1.37 kg 3.01 lb	42.863 1.6875	M325911: SHOULDER ON ID FRONTFACE
<b>327000 Series</b>											
EE327220	558.800 22.0000	129.380 5.0937	12.7 .50	- -	327355	901.573 35.4950	101.600 4.0000	6.4 .25	95.44 kg 210.44 lb	134.938 5.3125	327357D: GROOVE IN OD CENTER HOLES IN OD CENTER
					*327357DC	901.700 35.5000	212.725 8.3750	3.3 .13	202.54 kg 446.60 lb	292.100 11.5000	327357DC: HOLES IN OD CENTER
					*327357D	901.700 35.5000	212.725 8.3750	3.3 .13	202.54 kg 446.60 lb	292.100 11.5000	
<b>LL327000 Series</b>											
LL327049	133.350 5.2500	17.462 .6875	1.5 .06	.69 kg 1.52 lb	LL327010	173.038 6.8125	14.288 .5625	1.5 .06	.32 kg .71 lb	19.050 .7500	
<b>L327200 Series</b>											
L327249	133.350 5.2500	26.195 1.0313	1.5 .06	1.17 kg 2.58 lb	L327210	177.008 6.9688	20.638 .8125	1.5 .06	.54 kg 1.20 lb	25.400 1.0000	L327249XX: MADE FROM VACUUM MELT STEEL
L327249-B	133.350 5.2500	26.195 1.0313	1.5 .06	1.18 kg 2.60 lb	*L327210-B	177.008 6.9688	20.638 .8125	1.5 .06	.57 kg 1.26 lb	8.730 .3437	L327210-B: FLANGE ON OD FRONTFACE, BEARING WIDTH IS T1 DIMENSION
*L327249XX	133.350 5.2500	26.195 1.0313	1.5 .06	1.17 kg 2.58 lb	*L327210D	177.008 6.9688	47.625 1.8750	.8 .03	1.26 kg 2.77 lb	57.150 2.2500	L327210D: GROOVE IN OD CENTER HOLES IN OD CENTER
					*L327210DC	177.008 6.9688	47.625 1.8750	.8 .03	1.26 kg 2.78 lb	57.150 2.2500	L327210DC: HOLES IN OD CENTER
					*L327210XX	177.008 6.9688	20.638 .8125	1.5 .06	.54 kg 1.20 lb	25.400 1.0000	L327210XX: MADE FROM VACUUM MELT STEEL
L327248NA	133.350 5.2500	30.162 1.1875	1.5 .06	2.58 kg 5.69 lb	*L327210D	177.008 6.9688	47.625 1.8750	.8 .03	1.26 kg 2.77 lb	60.325 2.3750	
					*L327210DC	177.008 6.9688	47.625 1.8750	.8 .03	1.26 kg 2.78 lb	60.325 2.3750	
<b>M327300 Series</b>											
M327345	127.000 5.0000	46.038 1.8125	3.5 .14	3.58 kg 7.90 lb	67322	196.850 7.7500	38.100 1.5000	3.3 .13	1.44 kg 3.18 lb	46.036 1.8125	
M327349	133.350 5.2500	46.038 1.8125	3.5 .14	3.11 kg 6.86 lb							
<b>328000 Series</b>											
EE328167	425.450 16.7500	142.800 5.6220	12.7 .50	- -	*328268DC	685.698 26.9960	234.950 9.2500	3.3 .13	151.16 kg 333.30 lb	311.150 12.2500	328268D: GROOVE IN OD CENTER HOLES IN OD CENTER
					*328268D	685.698 26.9960	234.950 9.2500	3.3 .13	151.16 kg 333.30 lb	311.150 12.2500	328268DC: HOLES IN OD CENTER
					328269	685.698 26.9960	104.775 4.1250	6.4 .25	64.23 kg 141.62 lb	142.875 5.6250	
EE328167D	425.450 16.7500	253.873 9.9950	6.4 .25	- -	328269	685.698 26.9960	104.775 4.1250	6.4 .25	64.23 kg 141.62 lb	254.000 10.0000	
EE328172D	431.902 17.0040	253.873 9.9950	6.4 .25	- -							
<b>LM328000 Series</b>											
LM328048	139.700 5.5000	39.688 1.5625	3.3 .13	2.01 kg 4.43 lb	LM328011	188.912 7.4375	33.338 1.3125	3.3 .13	1.07 kg 2.35 lb	39.688 1.5625	
<b>LM328400 Series</b>											
*LM328444	136.525 5.3750	29.370 1.1563	1.5 .06	1.72 kg 3.80 lb	LM328410	187.325 7.3750	23.020 .9063	1.5 .06	.69 kg 1.51 lb	28.575 1.1250	LM328444: BROKEN FRONTFACE ID LM328448: BROKEN FRONTFACE ID

LM328400 SERIES CONTINUED ON NEXT PAGE

\*\*These Maximum Fillet Radii will be cleared by the Cone or Cup Radii.  
†Bore or O.D. shown are maximum dimensions. \*See Remarks Column.

LM328400 – M336900 SERIES

CONE			Max Shaft Fillet Radii R''	Weight	CUP			Max Hs'ng Fillet Radii r''	Weight	BEAR-ING	Remarks	
Number	BORE d	WIDTH B			Number	OUTSIDE DIA D	WIDTH C			WIDTH T		
LM328400 Series (cont)												
*LM328448	139.700 5.5000	29.370 1.1563	1.5 .06	1.56 kg 3.45 lb	LM328411	187.325 7.3750	34.500 1.3583	1.5 .06	1.07 kg 2.35 lb	35.293 1.3895		
329000 Series												
NA329115	300.787 11.8420	80.962 3.1875	6.4 .25	-	*329173DC	438.048 17.2460	123.825 4.8750	1.5 .06	24.81 kg 54.70 lb	161.925 6.3750	329173CD : GROOVE IN OD CENTER HOLES IN OD CENTER	
NA329116	300.787 11.8420	80.962 3.1875	6.4 .25	-	*329173D	438.048 17.2460	123.825 4.8750	1.5 .06	24.81 kg 54.70 lb	161.925 6.3750	329173D : GROOVE IN OD CENTER HOLES IN OD CENTER	
NA329120	304.800 12.0000	80.962 3.1875	6.4 .25	-	*329173CD	438.048 17.2460	123.825 4.8750	1.5 .06	22.79 kg 50.26 lb	161.925 6.3750	329173DC : HOLES IN OD CENTER	
NA329121	304.800 12.0000	80.962 3.1875	6.4 .25	-	*329176D	444.500 17.5000	161.925 6.3750	1.5 .06	34.70 kg 76.51 lb	161.925 6.3750	329176D : GROOVE IN OD CENTER HOLES IN OD CENTER	
EE329117D	304.648 11.9940	131.762 5.1875	3.3 .13	-	329172	438.048 17.2460	53.975 2.1250	3.3 .13	9.97 kg 21.98 lb	131.763 5.1875		
EE329118D	298.450 11.7500	131.762 5.1875	3.3 .13	54.57 kg 120.34 lb								
EE329119D	304.648 11.9940	131.762 5.1875	3.3 .13	51.59 kg 113.76 lb								
M329100 Series												
M329148NA	139.700 5.5000	44.450 1.7500	1.5 .06	-	M329114XD	219.075 8.6250	63.500 2.5000	1.5 .06	3.69 kg 8.13 lb	88.900 3.5000		
330000 Series												
*NA330107T	279.385 10.9994	76.200 3.0000	6.4 .25	-	*330166DA	422.275 16.6250	117.475 4.6250	.8 .03	19.39 kg 42.75 lb	152.400 6.0000	NA330107T: REVERSE TAPERED BORE	
*NA330112T	285.750 11.2500	76.200 3.0000	6.4 .25	-	*330167D	422.275 16.6250	117.475 4.6250	1.5 .06	19.39 kg 42.75 lb	152.400 6.0000	NA330112T: TAPERED BORE EE330116D: SHOULDER ON OD RIGHTFACE	
					*330178DA	454.025 17.8750	117.475 4.6250	1.5 .06	38.28 kg 84.40 lb	152.400 6.0000	330166DA : HOLES IN OD CENTER	
*EE330116D	292.100 11.5000	130.175 5.1250	3.2 .13	-	330166	422.275 16.6250	53.975 2.1250	3.3 .13	9.10 kg 20.07 lb	130.176 5.1250	330167D : GROOVE IN OD CENTER HOLES IN OD CENTER  330178DA : HOLES IN OD CENTER SPECIAL RADIUS ON LEFTFACE OD SPECIAL RADIUS ON RIGHTFACE OD SPHERICAL OD	
LM330400 Series												
LM330446	150.812 5.9375	41.275 1.6250	3.3 .13	2.40 kg 5.30 lb	LM330410	203.200 8.0000	34.925 1.3750	3.3 .13	1.20 kg 2.66 lb	41.275 1.6250	LM330410D : GROOVE IN OD CENTER HOLES IN OD CENTER	
LM330448	152.400 6.0000	41.275 1.6250	3.3 .13	2.28 kg 5.03 lb	*LM330410D	203.200 8.0000	79.375 3.1250	.8 .03	2.78 kg 6.13 lb	92.075 3.6250		
333000 Series												
EE333137	349.250 13.7500	84.138 3.3125	6.4 .25	36.33 kg 80.12 lb	*333197-B	501.650 19.7500	69.850 2.7500	3.3 .13	18.29 kg 40.34 lb	34.925 1.3750	333197-B : FLANGE ON OD FRONTFACE, BEARING WIDTH IS T1 DIMENSION	
EE333140	355.600 14.0000	84.138 3.3125	6.4 .25	34.02 kg 75.01 lb	333197	501.650 19.7500	69.850 2.7500	3.3 .13	16.67 kg 36.75 lb	90.488 3.5625	333203CD : GROOVE IN OD CENTER HOLES IN OD CENTER	
					*333203CD	514.350 20.2500	152.400 6.0000	1.5 .06	47.34 kg 104.40 lb	193.675 7.6250		
M333500 Series												
M333545D	161.000 6.3386	127.000 5.0000	1.5 .06	13.32 kg 29.38 lb	M333510	231.775 9.1250	34.925 1.3750	3.3 .13	1.90 kg 4.18 lb	120.650 4.7500	M333545TD: TAPERED BORE	
*M333545TD	161.000 6.3386	127.000 5.0000	1.5 .06	14.60 kg 32.19 lb							M333546TD: TAPERED BORE	
*M333546TD	161.000 6.3386	90.488 3.5625	1.5 .06	10.33 kg 22.79 lb	M333546TD may be paired with all single cups corresponding to M333545D and will require -.36512 mm (-1.4375 in) to be added to the T-width values.							
M336900 Series												
M336946	177.800 7.0000	57.150 2.2500	3.3 .13	6.76 kg 14.91 lb	M336912	265.112 10.4375	38.895 1.5313	3.3 .13	2.73 kg 6.03 lb	51.595 2.0313	M336949A: EXTENDED LARGE RIB SHOULDER ON OD BACKFACE	

8

\*\*These Maximum Fillet Radii will be cleared by the Cone or Cup Radii.  
†Bore or O.D. shown are maximum dimensions. \*See Remarks Column.

M336900 – LL352100 SERIES

CONE			Max Shaft Fillet Radii R <sup>**</sup>	Weight	CUP			Max Hs'ng Fillet Radii r <sup>**</sup>	Weight	BEARING WIDTH T	Remarks
Number	BORE d	WIDTH B			Number	OUTSIDE DIA D	WIDTH C				
<b>M336900 Series (cont)</b>											
M336947	177.800 7.0000	57.150 2.2500	9.7 .38	6.70 kg 14.77 lb							
M336948	178.595 7.0313	57.150 2.2500	3.3 .13	6.66 kg 14.69 lb							
M336949	179.934 7.0840	57.150 2.2500	3.3 .13	6.50 kg 14.32 lb							
*M336949A	179.388 7.0625	60.325 2.3750	3.3 .13	6.99 kg 15.41 lb	M336949A may be paired with all single cups corresponding to M336946 and will require 3.175 mm (.1250 in) to be added to the T-width values.						
<b>H337800 Series</b>											
H337840	165.087 6.4995	87.312 3.4375	1.5 .06	33.40 kg 73.66 lb	*H337816XDX 301.700 11.8780	196.850 7.7500	.9 .04	25.38 kg 55.96 lb	190.546 7.5018	H337840XX: MADE FROM VACUUM MELT STEEL	
*H337840XX	165.087 6.4995	87.312 3.4375	1.5 .06	33.40 kg 73.65 lb	*H337816XD 301.700 11.8780	196.850 7.7500	.9 .04	25.38 kg 55.96 lb	190.546 7.5018	H337846XX: MADE FROM VACUUM MELT STEEL H337816XD: SPECIAL CHAMFER ON LEFTFACE OD SPECIAL CHAMFER ON RIGHTFACE OD	
H337844	174.612 6.8745	87.312 3.4375	1.5 .06	30.01 kg 66.17 lb							
H337846	177.787 6.9995	87.312 3.4375	1.5 .06	28.73 kg 63.36 lb							
*H337846XX	177.787 6.9995	87.312 3.4375	1.5 .06	28.73 kg 63.35 lb						H337816XDX: MADE FROM VACUUM MELT STEEL SPECIAL CHAMFER ON LEFTFACE OD SPECIAL CHAMFER ON RIGHTFACE OD	
<b>341000 Series</b>											
EE341048	120.650 4.7500	59.530 2.3437	6.4 .25	- -	341096	244.475 9.6250	36.512 1.4375	3.3 .13	3.02 kg 6.66 lb	57.150 2.2500	
<b>H343200 Series</b>											
*†JH343249NW	220.000 8.6614	98.000 3.8583	3.0 .12	18.20 kg 40.14 lb	*†JH343210	340.000 13.3858	80.100 3.1535	1.5 .06	9.70 kg 21.39 lb	98.100 3.8622	JH343249NW: EXTENDED SMALL RIB FRONTFACE CHAMFER SLOTS IN FRONTFACE JH343210: SHOULDER ON OD BACKFACE
<b>M348400 Series</b>											
M348448WS	247.650 9.7500	63.500 2.5000	6.4 .25	12.17 kg 26.84 lb	M348410	346.075 13.6250	50.800 2.0000	6.4 .25	5.43 kg 11.97 lb	63.500 2.5000	M348449WS: KEYWAY IN ID FRONTFACE
M348449	247.650 9.7500	63.500 2.5000	6.4 .25	12.16 kg 26.82 lb							
*M348449WS	247.650 9.7500	63.500 2.5000	6.4 .25	12.05 kg 26.58 lb							
<b>M349500 Series</b>											
*M349546XX	255.600 10.0630	63.500 2.5000	1.5 .06	10.42 kg 22.97 lb	M349510	342.900 13.5000	44.450 1.7500	3.3 .13	4.01 kg 8.85 lb	57.150 2.2500	M349546XX: MADE FROM VACUUM MELT STEEL
M349547	255.600 10.0630	63.500 2.5000	1.5 .06	10.42 kg 22.97 lb	*M349510-B	342.900 13.5000	44.450 1.7500	3.3 .13	4.54 kg 10.01 lb	22.225 .8750	M349510-B: FLANGE ON OD FRONTFACE, BEARING WIDTH IS T1 DIMENSION
M349549	257.175 10.1250	57.150 2.2500	6.4 .25	9.40 kg 20.73 lb	*M349510W	342.900 13.5000	44.450 1.7500	3.3 .13	4.01 kg 8.84 lb	57.150 2.2500	M349510W: KEYWAY IN OD BACKFACE
M349549A	257.175 10.1250	57.150 2.2500	10.7 .42	9.16 kg 20.20 lb	M349511	342.900 13.5000	44.450 1.7500	3.3 .13	4.15 kg 9.15 lb	57.150 2.2500	M349512XX: MADE FROM VACUUM MELT STEEL
M349549W	257.175 10.1250	57.150 2.2500	6.4 .25	9.44 kg 20.82 lb	*M349512XX	342.900 13.5000	44.450 1.7500	3.3 .13	4.15 kg 9.15 lb	57.150 2.2500	
<b>350000 Series</b>											
EE350701	177.800 7.0000	95.250 3.7500	6.4 .25	- -	351687	428.625 16.8750	61.912 2.4375	6.4 .25	22.52 kg 49.65 lb	106.362 4.1875	
EE350750	190.500 7.5000	95.250 3.7500	6.4 .25	- -	351687V	428.625 16.8750	61.912 2.4375	6.4 .25	22.52 kg 49.65 lb	106.362 4.1875	
EE350750V	190.500 7.5000	95.250 3.7500	6.4 .25	- -							
<b>LL352100 Series</b>											
LL352148	279.400 11.0000	22.860 .9000	1.5 .06	1.76 kg 3.88 lb	LL352110	317.500 12.5000	18.288 .7200	1.5 .06	.74 kg 1.64 lb	22.860 .9000	
					LL352111	317.500 12.5000	17.653 .6950	1.5 .06	.71 kg 1.56 lb	22.225 .8750	
LL352149	279.400 11.0000	24.384 .9600	1.5 .06	1.85 kg 4.08 lb	LL352149 may be paired with all single cups corresponding to LL352148 and will require 1.524 mm (.0600 in) to be added to the T-width values.						

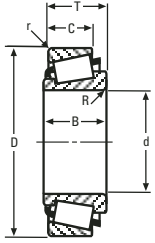

SINGLE ROW



SINGLE ROW WITH FLANGE

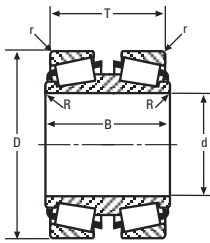

DOUBLE CONE

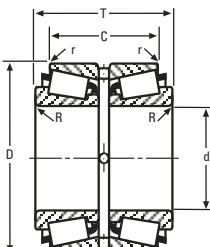

DOUBLE CUP

LL353200 – 380000 SERIES

CONE			Max Shaft Fillet Radii R''	Weight	CUP			Max H's'ng Fillet Radii r''	Weight	BEAR-ING	Remarks
Number	BORE d	WIDTH B			Number	OUTSIDE DIA D	WIDTH C			WIDTH T	
<b>LL353200 Series</b>											
LL353249	285.750 11.2500	20.638 .8125	1.5 .06	1.70 kg 3.74 lb	LL353210	323.850 12.7500	15.875 .6250	1.5 .06	.63 kg 1.38 lb	20.638 .8125	
<b>L357000 Series</b>											
L357040	289.974 11.4163	50.800 2.0000	6.4 .25	12.89 kg 28.42 lb	L357010	393.700 15.5000	38.100 1.5000	3.3 .13	4.33 kg 9.54 lb	50.800 2.0000	L357049NW: FRONTFACE CHAMFER SLOTS IN FRONTFACE
L357049	304.800 12.0000	50.800 2.0000	6.4 .25	10.13 kg 22.34 lb	*L357010CD	393.700 15.5000	82.550 3.2500	1.5 .06	9.22 kg 20.34 lb	107.950 4.2500	L357010CD : GROOVE IN OD CENTER HOLES IN OD CENTER
					*L357019-B	404.950 15.9429	38.100 1.5000	3.3 .13	7.26 kg 16.00 lb	22.225 .8750	L357019-B : FLANGE ON OD FRONTFACE, BEARING WIDTH IS T1 DIMENSION
*L357049NW	304.800 12.0000	53.975 2.1250	6.4 .25	10.66 kg 23.51 lb	L357010	393.700 15.5000	38.100 1.5000	3.3 .13	4.33 kg 9.54 lb	50.648 1.9940	
					*L357019-B	404.950 15.9429	38.100 1.5000	3.3 .13	7.26 kg 16.00 lb	22.073 .8690	
<b>LM361600 Series</b>											
LM361649	342.900 13.5000	66.675 2.6250	8.5 .33	18.07 kg 39.84 lb	LM361610	450.850 17.7500	52.388 2.0625	3.5 .14	8.32 kg 18.35 lb	66.673 2.6249	
LM361649A	343.154 13.5100	66.675 2.6250	8.5 .33	17.96 kg 39.61 lb							
<b>LL365300 Series</b>											
LL365347	384.175 15.1250	31.750 1.2500	3.5 .14	4.75 kg 10.48 lb	LL365310	441.325 17.3750	20.638 .8125	3.3 .13	1.87 kg 4.12 lb	28.575 1.1250	LL365310DC : HOLES IN OD CENTER
LL365348	384.175 15.1250	28.575 1.1250	3.5 .14	4.29 kg 9.46 lb	LL365310XD	441.325 17.3750	52.388 2.0625	.8 .03	5.31 kg 11.71 lb	68.263 2.6875	
					*LL365310DC	441.325 17.3750	52.388 2.0625	.8 .03	4.92 kg 10.85 lb	68.263 2.6875	
<b>LM371900 Series</b>											
*†JLM371942DG	475.000 18.7008	190.000 7.4803	3.3 .13	119.71 kg 263.96 lb	†JLM371914	620.000 24.4094	87.300 3.4370	6.4 .25	26.25 kg 57.89 lb	198.600 7.8189	JLM371942DG: EXTENDED SMALL RIB GROOVE IN ID
					†JLM371914W	620.000 24.4094	78.700 3.0984	6.4 .25	22.85 kg 50.39 lb	181.400 7.1417	JLM371914W : SLOTS IN BACKFACE
<b>LM377400 Series</b>											
LM377448	558.800 22.0000	104.775 4.1250	6.4 .25	- -	LM377410	736.600 29.0000	80.962 3.1875	6.4 .25	33.83 kg 74.60 lb	104.775 4.1250	LM377449DWV: HOLES IN OD CENTER
LM377449	558.800 22.0000	104.775 4.1250	6.4 .25	- -	*LM377410CD	736.600 29.0000	177.800 7.0000	1.5 .06	73.37 kg 161.79 lb	225.425 8.8750	LM377410CD : GROOVE IN OD CENTER HOLES IN OD CENTER
					*LM377410DXX	736.600 29.0000	177.800 7.0000	1.5 .06	73.37 kg 161.79 lb	225.425 8.8750	LM377410DXX : GROOVE IN OD CENTER HOLES IN OD CENTER
					LM377410XX	736.600 29.0000	80.962 3.1875	6.4 .25	33.83 kg 74.60 lb	104.775 4.1250	
LM377448D	558.800 22.0000	196.850 7.7500	3.3 .13	- -	LM377410	736.600 29.0000	80.962 3.1875	6.4 .25	33.83 kg 74.60 lb	196.850 7.7500	
LM377448DW	558.800 22.0000	196.850 7.7500	3.3 .13	- -	LM377410XX	736.600 29.0000	80.962 3.1875	6.4 .25	33.83 kg 74.60 lb	196.850 7.7500	
LM377448DWH	558.800 22.0000	196.850 7.7500	3.3 .13	- -							
LM377448DWV	558.800 22.0000	196.850 7.7500	3.3 .13	- -							
LM377448DXX	558.800 22.0000	196.850 7.7500	3.3 .13	- -							
LM377449D	558.800 22.0000	196.850 7.7500	3.3 .13	- -							
LM377449DW	558.800 22.0000	196.850 7.7500	3.3 .13	- -							
*LM377449DWV	558.800 22.0000	204.788 8.0625	3.0 .12	190.43 kg 419.90 lb							
<b>LL379000 Series</b>											
LL379049	596.900 23.5000	38.100 1.5000	3.5 .14	12.96 kg 28.58 lb	*LL379010-B	685.800 27.0000	31.750 1.2500	3.3 .13	7.49 kg 16.51 lb	13.492 .5312	LL379010-B : FLANGE ON OD FRONTFACE, BEARING WIDTH IS T1 DIMENSION
<b>380000 Series</b>											
EE380080	203.200 8.0000	95.250 3.7500	6.4 .25	- -	380190	482.600 19.0000	73.025 2.8750	6.4 .25	37.18 kg 81.98 lb	117.475 4.6250	

†These Maximum Fillet Radii will be cleared by the Cone or Cup Radii.  
†Bore or O.D. shown are maximum dimensions. \*See Remarks Column.

380000 SERIES CONTINUED ON NEXT PAGE

380000 – 420000 SERIES

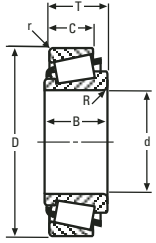

SINGLE ROW

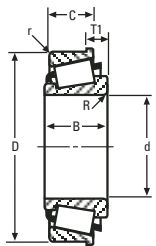

SINGLE ROW WITH FLANGE

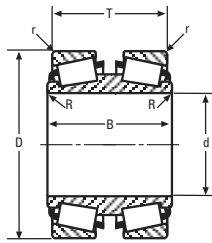

DOUBLE CONE

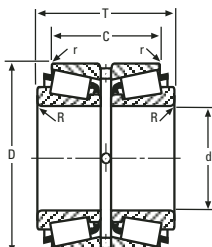

DOUBLE CUP

CONE			Max Shaft Fillet Radii R <sup>**</sup>	Weight	CUP			Max Hs'ng Fillet Radii r <sup>**</sup>	Weight	BEARING WIDTH T	Remarks
Number	BORE d	WIDTH B			Number	OUTSIDE DIA D	WIDTH C				
<b>380000 Series (cont)</b>											
EE380081	206.375 8.1250	95.250 3.7500	6.4 .25	-							
EE380875	222.250 8.7500	95.250 3.7500	6.4 .25	-							
<b>LL380800 Series</b>											
LL380849	647.700 25.5000	31.750 1.2500	3.5 .14	12.59 kg 27.76 lb	*LL380810-B	736.600 29.0000	25.400 1.0000	3.3 .13	6.55 kg 14.45 lb	13.495 .5313	LL380810-B : FLANGE ON OD FRONTFACE, BEARING WIDTH IS T1 DIMENSION
<b>LL382100 Series</b>											
LL382149	698.500 27.5000	63.500 2.5000	3.3 .13	37.07 kg 81.74 lb	LL382110	819.150 32.2500	50.800 2.0000	3.3 .13	17.59 kg 38.78 lb	63.500 2.5000	
<b>M383200 Series</b>											
M383240D	714.375 28.1250	339.725 13.3750	3.3 .13	-	M383210	1016.000 40.0000	142.875 5.6250	6.4 .25	138.97 kg 306.42 lb	339.726 13.3750	M383240DGW: GROOVE IN ID
*M383240DGW	714.375 28.1250	339.725 13.3750	3.3 .13	-							
<b>390000 Series</b>											
EE390090	228.600 9.0000	95.250 3.7500	6.4 .25	-	390200	508.000 20.0000	73.025 2.8750	6.4 .25	38.97 kg 85.92 lb	117.475 4.6250	
EE390095	241.300 9.5000	95.250 3.7500	6.4 .25	-							
<b>LL408000 Series</b>											
LL408049	57.150 2.2500	12.700 .5000	1.5 .06	.16 kg .35 lb	*LL408010-B	84.933 3.3438	9.525 .3750	1.5 .06	.08 kg .17 lb	5.969 .2350	LL408010-B : FLANGE ON OD FRONTFACE, BEARING WIDTH IS T1 DIMENSION
<b>H414200 Series</b>											
H414235	63.500 2.5000	41.275 1.6250	3.5 .14	2.13 kg 4.71 lb	*H414210-B	136.525 5.3750	31.750 1.2500	3.3 .13	.90 kg 1.98 lb	16.637 .6550	H414210-B : FLANGE ON OD FRONTFACE, BEARING WIDTH IS T1 DIMENSION
H414236	63.500 2.5000	41.275 1.6250	7.0 .28	2.10 kg 4.64 lb	H414210	136.525 5.3750	31.750 1.2500	3.3 .13	.78 kg 1.73 lb	41.275 1.6250	H414211W : KEYWAY BACKFACE
H414242	66.675 2.6250	41.275 1.6250	3.5 .14	2.03 kg 4.47 lb	*H414211W	136.525 5.3750	35.720 1.4063	3.3 .13	.97 kg 2.13 lb	45.245 1.7813	
H414245	68.262 2.6875	41.275 1.6250	3.5 .14	1.97 kg 4.35 lb							
H414245X	68.262 2.6875	41.275 1.6250	9.7 .38	1.90 kg 4.19 lb							
H414249	71.438 2.8125	41.275 1.6250	3.5 .14	1.86 kg 4.10 lb							
<b>H415600 Series</b>											
†JH415647	75.000 2.9528	51.000 2.0079	3.0 .12	2.62 kg 5.78 lb	†JH415610	140.000 5.7087	42.000 1.6535	2.5 .10	1.19 kg 2.63 lb	51.000 2.0079	
†JH415647A	75.000 2.9528	51.000 2.0079	9.7 .38	2.61 kg 5.76 lb							
<b>420000 Series</b>											
EE420651	165.100 6.5000	88.897 3.4999	9.7 .38	31.85 kg 70.23 lb	421417	360.000 14.1732	63.500 2.5000	3.3 .13	11.20 kg 24.71 lb	92.075 3.6250	EE420750TD: TAPERED BORE
EE420701	177.800 7.0000	88.897 3.4999	12.7 .50	29.30 kg 64.61 lb	*421437-B	365.049 14.3720	63.500 2.5000	3.3 .13	13.57 kg 29.92 lb	41.275 1.6250	EE420812TD: KEYWAY IN ID TAPERED BORE
EE420751	190.500 7.5000	88.897 3.4999	6.4 .25	27.02 kg 59.58 lb	421437	365.049 14.3720	63.500 2.5000	3.3 .13	12.63 kg 27.85 lb	92.075 3.6250	421437-B : FLANGE ON OD FRONTFACE, BEARING WIDTH IS T1 DIMENSION
EE420793	201.612 7.9375	88.897 3.4999	3.3 .13	24.71 kg 54.48 lb	421450	368.300 14.5000	63.500 2.5000	3.3 .13	13.56 kg 29.90 lb	92.075 3.6250	421451CD : GROOVE IN OD CENTER HOLES IN OD CENTER
EE420793W	201.612 7.9375	88.897 3.4999	3.3 .13	24.88 kg 54.87 lb	*421451CD	368.300 14.5000	136.525 5.3750	1.5 .06	28.13 kg 62.03 lb	193.675 7.6250	421455D : GROOVE IN OD CENTER HOLES IN OD CENTER
EE420801	203.200 8.0000	88.897 3.4999	3.3 .13	24.36 kg 53.71 lb	*421455D	368.300 14.5000	133.350 5.2500	1.5 .06	28.61 kg 63.08 lb	190.500 7.5000	
EE420812X	206.375 8.1250	88.897 3.4999	6.4 .25	23.57 kg 51.97 lb	421462XD	371.475 14.6250	136.525 5.3750	1.5 .06	31.92 kg 70.38 lb	193.675 7.6250	
EE420750D	190.500 7.5000	152.400 6.0000	3.3 .13	59.11 kg 130.33 lb	421417	360.000 14.1732	63.500 2.5000	3.3 .13	11.20 kg 24.71 lb	158.750 6.2500	
*EE420750TD	190.500 7.5000	152.400 6.0000	3.2 .12	59.11 kg 130.33 lb	421437	365.049 14.3720	63.500 2.5000	3.3 .13	12.63 kg 27.85 lb	158.750 6.2500	
EE420800D	203.200 8.0000	152.400 6.0000	3.3 .13	53.35 kg 117.64 lb	421450	368.300 14.5000	63.500 2.5000	3.3 .13	13.56 kg 29.90 lb	158.750 6.2500	

420000 SERIES CONTINUED ON NEXT PAGE

\*\*These Maximum Fillet Radii will be cleared by the Cone or Cup Radii.  
†Bore or O.D. shown are maximum dimensions. \*See Remarks Column.

CONE			Max Shaft Fillet Radii R <sup>**</sup>	Weight	CUP			Max Hs'ng Fillet Radii r <sup>**</sup>	Weight	BEAR-ING	Remarks
Number	BORE d	WIDTH B			Number	OUTSIDE DIA D	WIDTH C			WIDTH T	
<b>420000 Series (cont)</b>											
EE420801D	203.200 8.0000	158.750 6.2500	3.3 .13	53.89 kg 118.84 lb							
EE420804D	203.276 8.0030	152.400 6.0000	3.3 .13	53.35 kg 117.64 lb							
*EE420812TD	206.375 8.1250	152.400 6.0000	3.0 .12	58.10 kg 128.11 lb							
EE420850	215.900 8.5000	79.372 3.1249	1.5 .06	19.64 kg 43.30 lb	EE420850 may be paired with all single cups corresponding to EE420651 and will require -.9525 mm (-.3750 in) to be added to the T-width values. EE420850 may be paired with all double cups corresponding to EE420651 and will require -.19050 mm (-.7500 in) to be added to the T-width values.						
<b>L420400 Series</b>											
L420449	101.600 4.0000	21.433 .8438	1.5 .06	.58 kg 1.29 lb	L420410	136.525 5.3750	16.670 .6563	1.5 .06	.27 kg .59 lb	21.433 .8438	
<b>LL420500 Series</b>											
LL420549	101.600 4.0000	15.083 .5938	1.5 .06	.40 kg .88 lb	LL420510	134.938 5.3125	11.908 .4688	1.5 .06	.16 kg .36 lb	15.875 .6250	
<b>HH421200 Series</b>											
HH421246C	98.425 3.8750	63.500 2.5000	6.4 .25	4.75 kg 10.48 lb	HH421210	184.150 7.2500	52.388 2.0625	3.3 .13	2.52 kg 5.56 lb	63.500 2.5000	HH421246CV: MADE FROM VACUUM MELT STEEL HH421210V: MADE FROM VACUUM MELT STEEL
*HH421246CV	98.425 3.8750	63.500 2.5000	6.4 .25	4.75 kg 10.48 lb	*HH421210V	184.150 7.2500	52.388 2.0625	3.3 .13	2.52 kg 5.56 lb	63.500 2.5000	
<b>423000 Series</b>											
EE423181D	457.200 18.0000	209.550 8.2500	6.4 .25	- -	423296	749.808 29.5200	95.250 3.7500	6.4 .25	47.75 kg 105.28 lb	215.900 8.5000	
EE423181XD	457.200 18.0000	209.550 8.2500	- -	- -	423300	761.873 29.9950	95.250 3.7500	6.4 .25	58.41 kg 128.78 lb	215.900 8.5000	
EE423187D	456.794 17.9840	209.550 8.2500	6.4 .25	- -							
<b>424000 Series</b>											
EE424257D	647.700 25.5000	273.050 10.7500	11.0 .43	- -	424405	1028.700 40.5000	120.650 4.7500	6.4 .25	134.48 kg 296.53 lb	279.400 11.0000	
EE424258D	649.930 25.5878	272.900 10.7441	9.7 .38	- -							
<b>H424400 Series</b>											
H424434	107.950 4.2500	58.738 2.3125	3.3 .13	- -	H424415	201.612 7.9375	44.450 1.7500	3.3 .13	2.51 kg 5.54 lb	57.150 2.2500	
H424442	114.300 4.5000	58.738 2.3125	3.3 .13	- -							
<b>425000 Series</b>											
EE425176D	456.794 17.9840	254.000 10.0000	3.3 .13	- -	425299	761.873 29.9950	101.600 4.0000	6.4 .25	72.85 kg 160.64 lb	254.000 10.0000	425299D : GROOVE IN OD CENTER HOLES IN OD CENTER
425178D	456.794 17.9840	254.000 10.0000	3.3 .13	- -							
425179D	456.794 17.9840	254.000 10.0000	3.3 .13	- -							
EE425179A	456.794 17.9840	142.875 5.6250	16.0 .63	- -	425299	761.873 29.9950	101.600 4.0000	6.4 .25	72.85 kg 160.64 lb	142.875 5.6250	
					*425299D	761.873 29.9950	222.250 8.7500	3.3 .13	160.17 kg 353.18 lb	304.800 12.0000	
<b>426000 Series</b>											
EE426198D	505.181 19.8890	266.700 10.5000	6.4 .25	- -	426330	838.200 33.0000	104.775 4.1250	9.7 .38	103.76 kg 228.79 lb	266.700 10.5000	426331CD : GROOVE IN OD CENTER HOLES IN OD CENTER
EE426202D	509.397 20.0550	266.700 10.5000	6.4 .25	- -							
EE426200	508.000 20.0000	139.700 5.5000	9.7 .38	- -	426330	838.200 33.0000	104.775 4.1250	9.7 .38	103.76 kg 228.79 lb	146.050 5.7500	
					*426331CD	838.200 33.0000	222.250 8.7500	3.3 .13	217.05 kg 478.58 lb	304.800 12.0000	
<b>HH427300 Series</b>											
HH427346	127.000 5.0000	76.995 3.0313	8.0 .31	- -	HH427315	234.950 9.2500	55.562 2.1875	3.3 .13	4.56 kg 10.06 lb	71.438 2.8125	

\*\*These Maximum Fillet Radii will be cleared by the Cone or Cup Radii.  
†Bore or O.D. shown are maximum dimensions. \*See Remarks Column.

428000 – 435000 SERIES

CONE			Max Shaft Fillet Radii R <sup>**</sup>	Weight	CUP			Max Hs'ng Fillet Radii r <sup>**</sup>	Weight	BEARING WIDTH T	Remarks
Number	BORE d	WIDTH B			Number	OUTSIDE DIA D	WIDTH C				
<b>428000 Series</b>											
*EE428262D	660.400 26.0000	311.942 12.2812	6.4 .25	-	428420	1066.800 42.0000	139.700 5.5000	6.4 .25	176.90 kg 390.07 lb	321.470 12.6563	EE428262D: HOLES IN OD CENTER
EE428262DA	660.400 26.0000	311.942 12.2812	6.4 .25	-	428423	1069.900 42.1220	139.700 5.5000	10.0 .39	181.81 kg 400.88 lb	321.470 12.6563	EE428263D: ASYMMETRICAL BEARING SHOULDER ON OD RIGHTFACE
*EE428263D	659.925 25.9813	316.857 12.4747	6.0 .24	-	EE428263D may be paired with all single cups corresponding to EE428262D and will require .150 mm (.0059 in) to be added to the T-width values.						
<b>LL428300 Series</b>											
LL428349	139.700 5.5000	20.638 .8125	1.5 .06	.89 kg 1.96 lb	LL428310	180.975 7.1250	16.670 .6563	1.5 .06	.42 kg .92 lb	21.432 .8438	
<b>H429100 Series</b>											
†JH429149	130.000 5.1181	72.000 2.8346	8.0 .31	9.55 kg 21.06 lb	†JH429110	240.000 9.4488	60.000 2.3622	7.0 .28	4.82 kg 10.64 lb	76.000 2.9921	
<b>H429600 Series</b>											
H429648	139.700 5.5000	65.088 2.5625	1.5 .06	8.32 kg 18.35 lb	H429611	246.858 9.7188	46.038 1.8125	3.3 .13	3.53 kg 7.79 lb	60.325 2.3750	H429611YD : HOLES IN OD CENTER
					*H429611YD	246.858 9.7188	123.825 4.8750	1.5 .06	10.33 kg 22.78 lb	152.400 6.0000	
<b>430000 Series</b>											
EE430888	225.425 8.8750	87.312 3.4375	1.5 .06	28.29 kg 62.37 lb	431575	400.050 15.7500	63.500 2.5000	3.3 .13	15.76 kg 34.75 lb	88.900 3.5000	431575CD : GROOVE IN OD CENTER HOLES IN OD CENTER
EE430900	228.600 9.0000	87.312 3.4375	10.5 .41	27.21 kg 59.99 lb	*431576CD	400.050 15.7500	136.525 5.3750	1.5 .06	33.43 kg 73.70 lb	187.325 7.3750	
EE430902	228.600 9.0000	87.312 3.4375	19.8 .78	26.35 kg 58.11 lb							
EE430901D	228.600 9.0000	161.925 6.3750	3.3 .13	66.31 kg 146.20 lb	431575	400.050 15.7500	63.500 2.5000	3.3 .13	15.76 kg 34.75 lb	158.750 6.2500	
<b>M432100 Series</b>											
M432144	149.987 5.9050	47.625 1.8750	3.3 .13	4.66 kg 10.28 lb	M432111	223.838 8.8125	36.512 1.4375	3.3 .13	1.77 kg 3.90 lb	46.037 1.8125	
M432148A	157.162 6.1875	47.625 1.8750	1.5 .06	4.01 kg 8.85 lb							
<b>L432300 Series</b>											
L432348	158.750 6.2500	23.812 .9375	4.8 .19	1.29 kg 2.85 lb	L432310	205.582 8.0938	18.258 .7188	1.5 .06	.58 kg 1.28 lb	23.812 .9375	L432310DXX : GROOVE IN OD CENTER HOLES IN OD CENTER MADE FROM VACUUM MELT STEEL
L432349	158.750 6.2500	23.812 .9375	1.5 .06	1.34 kg 2.94 lb	*L432310DXX	205.582 8.0938	44.770 1.7626	.8 .03	1.44 kg 3.18 lb	55.879 2.2000	
<b>H432500 Series</b>											
H432549D	155.575 6.1250	122.238 4.8125	1.5 .06	19.16 kg 42.24 lb	H432510	247.650 9.7500	52.388 2.0625	3.3 .13	4.00 kg 8.82 lb	122.237 4.8125	H432549TD: ASYMMETRICAL BEARING TAPERED BORE
*H432549TD	155.575 6.1250	122.238 4.8125	1.6 .06	20.33 kg 44.82 lb							
<b>H432600 Series</b>											
H432640	139.687 5.4995	77.788 3.0625	1.5 .06	13.49 kg 29.75 lb	H432610	269.875 10.6250	64.000 2.5197	3.3 .13	6.50 kg 14.33 lb	77.000 3.0315	
H432649	152.387 5.9995	77.788 3.0625	1.5 .06	11.72 kg 25.84 lb							
<b>433000 Series</b>											
EE43301D	762.000 30.0000	311.150 12.2500	6.4 .25	-	433512	1295.400 51.0000	130.175 5.1250	6.4 .25	224.47 kg 494.96 lb	311.151 12.2500	
<b>L433700 Series</b>											
L433749	165.100 6.5000	26.195 1.0313	1.5 .06	1.63 kg 3.60 lb	*L433710-B	215.900 8.5000	20.638 .8125	1.5 .06	.78 kg 1.72 lb	10.320 .4063	L433710-B : FLANGE ON OD FRONTFACE, BEARING WIDTH IS T1 DIMENSION
					L433710	215.900 8.5000	20.638 .8125	1.5 .06	.72 kg 1.59 lb	26.195 1.0313	L433710D : GROOVE IN OD CENTER HOLES IN OD CENTER
					*L433710D	215.900 8.5000	47.625 1.8750	.8 .03	1.71 kg 3.78 lb	58.740 2.3126	
<b>435000 Series</b>											
EE435102	260.350 10.2500	84.138 3.3125	6.4 .25	26.80 kg 59.09 lb	435165V	419.100 16.5000	61.912 2.4375	3.3 .13	14.61 kg 32.23 lb	85.725 3.3750	435165D : GROOVE IN OD CENTER HOLES IN OD CENTER
					435165	419.100 16.5000	61.912 2.4375	3.3 .13	14.61 kg 32.23 lb	85.725 3.3750	435165DC : HOLES IN OD CENTER

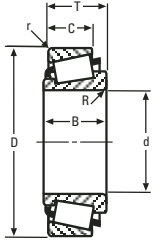

SINGLE ROW

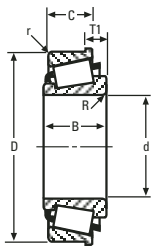

SINGLE ROW WITH FLANGE

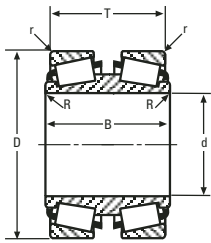

DOUBLE CONE

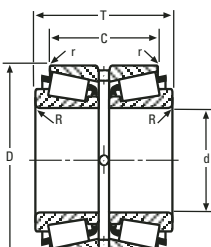

DOUBLE CUP

435000 SERIES CONTINUED ON NEXT PAGE

\*\*These Maximum Fillet Radii will be cleared by the Cone or Cup Radii.  
†Bore or O.D. shown are maximum dimensions. \*See Remarks Column.



435000 – LM451300 SERIES

8

CONE			Max Shaft Fillet Radii R''	Weight	CUP			Max Hs'ng Fillet Radii r''	Weight	BEAR-ING	Remarks
Number	BORE d	WIDTH B			Number	OUTSIDE DIA D	WIDTH C			WIDTH T	
435000 Series (cont)											
					*435165DC	419.100 16.5000	136.525 5.3750	1.5 .06	33.18 kg 73.17 lb	184.150 7.2500	
					*435165D	419.100 16.5000	136.525 5.3750	1.5 .06	33.18 kg 73.17 lb	184.150 7.2500	
EE435103D	260.350 10.2500	155.575 6.1250	3.3 .13	65.21 kg 143.78 lb	435165V	419.100 16.5000	61.912 2.4375	3.3 .13	14.61 kg 32.23 lb	158.750 6.2500	
EE435103DV	260.350 10.2500	155.575 6.1250	3.3 .13	65.21 kg 143.78 lb	435165	419.100 16.5000	61.912 2.4375	3.3 .13	14.61 kg 32.23 lb	158.750 6.2500	
L435000 Series											
L435049	171.450 6.7500	24.608 .9688	1.5 .06	1.63 kg 3.59 lb	L435010	222.250 8.7500	19.050 .7500	1.5 .06	.70 kg 1.54 lb	25.400 1.0000	L435049XX: MADE FROM VACUUM MELT STEEL
*L435049XX	171.450 6.7500	24.608 .9688	1.5 .06	1.63 kg 3.59 lb	*L435010XX	222.250 8.7500	19.050 .7500	1.5 .06	.70 kg 1.54 lb	25.400 1.0000	L435010XX: MADE FROM VACUUM MELT STEEL
HH437500 Series											
HH437549	165.100 6.5000	95.250 3.7500	3.3 .13	25.89 kg 57.10 lb	HH437510	336.550 13.2500	69.850 2.7500	6.4 .25	12.26 kg 27.03 lb	92.075 3.6250	HH437549XX: MADE FROM VACUUM MELT STEEL
*HH437549XX	165.100 6.5000	95.250 3.7500	3.3 .13	25.89 kg 57.10 lb	*HH437510XX	336.550 13.2500	69.850 2.7500	6.4 .25	12.26 kg 27.03 lb	92.075 3.6250	HH437510XX: MADE FROM VACUUM MELT STEEL
LM446300 Series											
LM446349	234.950 9.2500	46.038 1.8125	3.5 .14	6.22 kg 13.73 lb	LM446310	311.150 12.2500	33.338 1.3125	3.3 .13	2.55 kg 5.63 lb	46.037 1.8125	LM446310D: GROOVE IN OD CENTER HOLES IN OD CENTER
					LM446310CD	311.150 12.2500	73.025 2.8750	.8 .03	5.84 kg 12.88 lb	98.425 3.8750	LM446310W: KEYWAY IN OD BACKFACE
					*LM446310D	311.150 12.2500	73.025 2.8750	.8 .03	5.84 kg 12.88 lb	98.425 3.8750	
					*LM446310W	311.150 12.2500	33.338 1.3125	3.3 .13	2.56 kg 5.64 lb	46.037 1.8125	
450000 Series											
EE450551	139.700 5.5000	93.662 3.6875	9.7 .38	20.52 kg 45.25 lb	†J451161	295.000 11.6142	61.912 2.4375	5.0 .20	7.02 kg 15.48 lb	88.900 3.5000	EE450601XS: SPECIAL BACKFACE RADIUS
EE450577	146.050 5.7500	93.662 3.6875	9.7 .38	19.47 kg 42.93 lb	451212	307.975 12.1250	61.912 2.4375	6.8 .27	10.29 kg 22.69 lb	88.900 3.5000	451215CD: GROOVE IN OD CENTER HOLES IN OD CENTER
EE450601	152.400 6.0000	93.662 3.6875	9.7 .38	18.37 kg 40.51 lb	*451215CD	307.975 12.1250	146.050 5.7500	2.3 .09	23.47 kg 51.75 lb	200.025 7.8750	
*EE450601XS	151.994 5.9840	93.662 3.6875	8.2 .32	18.62 kg 41.07 lb	451250	317.500 12.5000	61.912 2.4375	6.8 .27	12.82 kg 28.27 lb	88.900 3.5000	
EE450600D	152.400 6.0000	171.450 6.7500	9.7 .38	41.58 kg 91.69 lb	†J451161	295.000 11.6142	61.912 2.4375	5.0 .20	7.02 kg 15.48 lb	161.925 6.3750	
450900D	152.400 6.0000	171.450 6.7500	9.7 .38	40.62 kg 89.57 lb	451212	307.975 12.1250	61.912 2.4375	6.8 .27	10.29 kg 22.69 lb	161.925 6.3750	
450931D	134.900 5.3110	171.450 6.7500	spcl. spcl.	44.99 kg 99.20 lb	451250	317.500 12.5000	61.912 2.4375	6.8 .27	12.82 kg 28.27 lb	161.925 6.3750	
450950D	139.700 5.5000	171.450 6.7500	spcl. spcl.	44.54 kg 98.21 lb							
†J450590	150.000 5.9055	80.000 3.1496	5.0 .20	17.17 kg 37.85 lb	J450590 may be paired with all single cups corresponding to EE450551 and will require -8.900 mm (-.3504 in) to be added to the T-width values. J450590 may be paired with all double cups corresponding to EE450551 and will require -17.800 mm (-.7008 in) to be added to the T-width values.						
LL450700 Series											
*LL450748A	266.560 10.4945	33.470 1.3177	1.5 .06	3.54 kg 7.82 lb	38820	325.438 12.8125	25.400 1.0000	1.5 .06	1.88 kg 4.14 lb	29.500 1.1614	LL450748A: SPECIAL FRONTFACE RADIUS
*LL450749	266.700 10.5000	33.470 1.3177	1.5 .06	3.53 kg 7.78 lb							LL450749: SPECIAL FRONTFACE RADIUS
*LL450749AA	266.700 10.5000	34.039 1.3401	1.5 .06	3.56 kg 7.85 lb							LL450749AA: SPECIAL FRONTFACE RADIUS
LM451300 Series											
LM451344	262.974 10.3533	62.000 2.4409	3.5 .14	11.64 kg 25.67 lb	LM451310	355.600 14.0000	44.450 1.7500	3.3 .13	4.36 kg 9.61 lb	57.150 2.2500	LM451349AXV: MADE FROM VACUUM MELT STEEL
LM451345	263.525 10.3750	57.150 2.2500	3.5 .14	11.11 kg 24.50 lb	*LM451310-B	355.600 14.0000	44.450 1.7500	3.3 .13	5.17 kg 11.40 lb	22.225 .8750	LM451349DGA: ASYMMETRICAL BEARING EXTENDED SMALL RIB GROOVE IN ID

†These Maximum Fillet Radii will be cleared by the Cone or Cup Radii.  
†Bore or O.D. shown are maximum dimensions. \*See Remarks Column.

**LM451300 – L467500 SERIES**

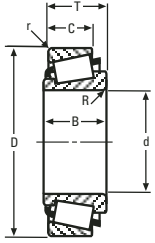

**SINGLE ROW**

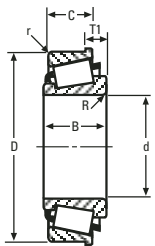

**SINGLE ROW WITH FLANGE**

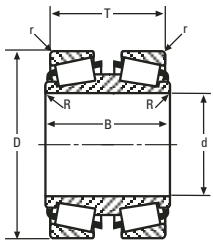

**DOUBLE CONE**

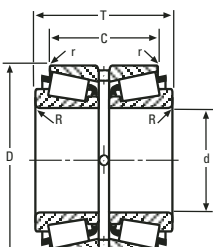

**DOUBLE CUP**

CONE			Max Shaft Fillet Radii R**	Weight	CUP			Max Hs'ng Fillet Radii r**	Weight	BEARING WIDTH T	Remarks
Number	BORE d	WIDTH B			Number	OUTSIDE DIA D	WIDTH C				
<b>LM451300 Series (cont)</b>											
LM451347	264.975 10.4321	62.000 2.4409	3.5 .14	11.24 kg 24.79 lb	*LM451310CD	355.600 14.0000	101.600 4.0000	1.5 .06	10.11 kg 22.30 lb	127.000 5.0000	LM451349DGDW: GROOVE IN ID
LM451349	266.700 10.5000	57.150 2.2500	3.5 .14	10.52 kg 23.19 lb	*LM451310DV	355.600 14.0000	101.600 4.0000	1.5 .06	10.11 kg 22.30 lb	127.000 5.0000	LM451349DWA: ASYMMETRICAL BEARING EXTENDED SMALL RIB
LM451349A	266.700 10.5000	57.150 2.2500	10.5 .41	10.19 kg 22.47 lb	*LM451310V	355.600 14.0000	44.450 1.7500	3.3 .13	4.36 kg 9.61 lb	57.150 2.2500	LM451349H: GROOVE IN OD FRONTFACE NO SMALL RIB
LM451349AX	266.700 10.5000	57.150 2.2500	9.7 .38	10.24 kg 22.59 lb	LM451310W	355.600 14.0000	44.450 1.7500	3.3 .13	4.35 kg 9.60 lb	57.150 2.2500	LM451349H: GROOVE IN OD FRONTFACE SHOULDER ON OD FRONTFACE
*LM451349AXV	266.700 10.5000	57.150 2.2500	9.7 .38	10.23 kg 22.55 lb	LM451312	357.200 14.0630	44.450 1.7500	3.3 .13	4.67 kg 10.30 lb	57.150 2.2500	LM451349TD: TAPERED BORE
*LM451349H	266.700 10.5000	60.325 2.3750	3.5 .14	10.69 kg 23.56 lb	*LM451312D	357.200 14.0630	101.600 4.0000	1.5 .06	10.60 kg 23.38 lb	127.000 5.0000	LM451349V: MADE FROM VACUUM MELT STEEL
*LM451349V	266.700 10.5000	57.150 2.2500	3.5 .14	10.60 kg 23.38 lb							LM451310-B: FLANGE ON OD FRONTFACE, BEARING WIDTH IS T1 DIMENSION
LM451349W	266.700 10.5000	57.150 2.2500	3.5 .14	10.45 kg 23.03 lb							LM451310CD: GROOVE IN OD CENTER HOLES IN OD CENTER
LM451349D	266.700 10.5000	109.538 4.3125	1.5 .06	24.28 kg 53.53 lb	LM451310	355.600 14.0000	44.450 1.7500	3.3 .13	4.36 kg 9.61 lb	107.950 4.2500	LM451310DV: GROOVE IN OD CENTER HOLES IN OD CENTER
*LM451349DGA	266.700 10.5000	115.092 4.5312	1.5 .06	24.97 kg 55.05 lb	*LM451310V	355.600 14.0000	44.450 1.7500	3.3 .13	4.36 kg 9.61 lb	107.950 4.2500	LM451310V: MADE FROM VACUUM MELT STEEL
*LM451349DGDW	266.700 10.5000	109.538 4.3125	1.5 .06	24.46 kg 53.93 lb	LM451310W	355.600 14.0000	44.450 1.7500	3.3 .13	4.35 kg 9.60 lb	107.950 4.2500	LM451310V: MADE FROM VACUUM MELT STEEL
LM451349DW	266.700 10.5000	109.538 4.3125	1.5 .06	24.23 kg 53.43 lb	LM451312	357.200 14.0630	44.450 1.7500	3.3 .13	4.67 kg 10.30 lb	107.950 4.2500	LM451312D: GROOVE IN OD CENTER HOLES IN OD CENTER
*LM451349DWA	266.700 10.5000	115.092 4.5312	1.5 .06	24.97 kg 55.05 lb							LM451447DGDW: ASYMMETRICAL BEARING EXTENDED SMALL RIB GROOVE IN ID
*LM451349TD	266.700 10.5000	109.538 4.3125	1.5 .06	25.90 kg 57.10 lb							LM451412W: SLOTS IN BACKFACE
<b>LM451400 Series</b>											
*LM451447DGDW	266.700 10.5000	115.092 4.5312	1.5 .06	23.93 kg 52.77 lb	*LM451412X	355.600 14.0000	49.373 1.9438	1.5 .06	4.45 kg 9.82 lb	116.535 4.5880	LM451412X: SHOULDER ON OD BACKFACE
					*LM451412W	355.600 14.0000	45.138 1.7771	3.3 .13	4.58 kg 10.10 lb	108.066 4.2546	LM451412W: SLOTS IN BACKFACE
<b>455000 Series</b>											
EE455051	127.000 5.0000	88.900 3.5000	6.4 .25	17.61 kg 38.83 lb	455112X	285.000 11.2205	63.000 2.4803	6.4 .25	7.97 kg 17.57 lb	85.003 3.3466	455958: SPECIAL BACKFACE RADIUS
EE455055X	140.000 5.5118	88.900 3.5000	12.0 .47	15.45 kg 34.06 lb	455116	295.275 11.6250	63.500 2.5000	6.4 .25	10.90 kg 24.04 lb	85.728 3.3751	
*455955T	139.700 5.5000	88.900 3.5000	3.3 .13	16.09 kg 35.49 lb	455119XD	295.275 11.6250	146.050 5.7500	1.5 .06	24.67 kg 54.40 lb	190.507 7.5003	455955T: TAPERED BORE
*455958	139.878 5.5070	88.900 3.5000	15.8 .62	14.00 kg 30.86 lb							
455959	139.700 5.5000	88.900 3.5000	3.3 .13	15.41 kg 33.99 lb							
EE455052D	133.350 5.2500	171.450 6.7500	9.7 .38	40.52 kg 89.35 lb	455112X	285.000 11.2205	63.000 2.4803	6.4 .25	7.97 kg 17.57 lb	163.657 6.4432	
455948D	139.700 5.5000	171.450 6.7500	3.3 .13	38.06 kg 83.91 lb	455116	295.275 11.6250	63.500 2.5000	6.4 .25	10.90 kg 24.04 lb	165.100 6.5000	
<b>LL455600 Series</b>											
†JLL455649	300.000 11.8110	21.000 .8268	2.3 .09	1.92 kg 4.24 lb	†JLL455610	345.000 13.5827	17.000 .6693	1.5 .06	.93 kg 2.05 lb	23.000 .9055	
<b>HM456900 Series</b>											
HM456949	292.100 11.5000	93.662 3.6875	9.7 .38	82.56 kg 182.05 lb	*HM456910CD	469.900 18.5000	149.225 5.8750	1.5 .06	35.01 kg 77.20 lb	200.025 7.8750	HM456910CD: GROOVE IN OD CENTER HOLES IN OD CENTER
<b>L467500 Series</b>											
L467549	406.400 16.0000	61.912 2.4375	3.3 .13	17.73 kg 39.08 lb	*L467510-B	508.000 20.0000	47.625 1.8750	3.3 .13	9.48 kg 20.90 lb	25.400 1.0000	L467510-B: FLANGE ON OD FRONTFACE, BEARING WIDTH IS T1 DIMENSION
					L467510	508.000 20.0000	47.625 1.8750	3.3 .13	8.59 kg 18.94 lb	61.912 2.4375	

LL469900 SERIES CONTINUED ON NEXT PAGE

\*\*These Maximum Fillet Radii will be cleared by the Cone or Cup Radii.  
†Bore or O.D. shown are maximum dimensions. \*See Remarks Column.

LL469900 – XR496000 SERIES

CONE			Max Shaft Fillet Radii R <sup>1</sup>	Weight	CUP			Max Hs'ng Fillet Radii r <sup>1</sup>	Weight	BEARING WIDTH T	Remarks
Number	BORE d	WIDTH B			Number	OUTSIDE DIA D	WIDTH C				
<b>LL469900 Series</b>											
LL469949	447.675 17.6250	41.618 1.6385	3.3 .13	12.80 kg 28.23 lb	LL469910	552.450 21.7500	32.545 1.2813	3.3 .13	7.95 kg 17.54 lb	44.450 1.7500	
<b>470000 Series</b>											
EE470073	177.800 7.0000	92.075 3.6250	13.5 .53	22.20 kg 48.96 lb	470128	327.025 12.8750	63.500 2.5000	6.4 .25	8.53 kg 18.80 lb	90.487 3.5625	470977T: TAPERED BORE  470132-B : FLANGE ON OD FRONTFACE, BEARING WIDTH IS T1 DIMENSION
EE470075	190.500 7.5000	92.075 3.6250	6.4 .25	19.88 kg 43.83 lb	470130	330.200 13.0000	63.500 2.5000	6.4 .25	9.59 kg 21.14 lb	90.487 3.5625	
EE470078	177.800 7.0000	92.075 3.6250	6.4 .25	22.53 kg 49.67 lb	*470132-B	336.550 13.2500	63.500 2.5000	6.4 .25	12.54 kg 27.65 lb	44.450 1.7500	
EE470078X	177.800 7.0000	92.075 3.6250	9.7 .38	22.41 kg 49.41 lb	470132	336.550 13.2500	63.500 2.5000	6.4 .25	11.24 kg 24.79 lb	90.487 3.5625	
*470977T	185.738 7.3125	92.075 3.6250	3.3 .13	20.97 kg 46.23 lb	470133	339.725 13.3750	63.500 2.5000	6.4 .25	13.29 kg 29.30 lb	90.487 3.5625	
470978	177.800 7.0000	92.075 3.6250	6.4 .25	21.64 kg 47.71 lb							
470975	190.500 7.5000	84.138 3.3125	4.8 .19	17.68 kg 38.99 lb	470975 may be paired with all single cups corresponding to EE470073 and will require -7.938 mm (-.3125 in) to be added to the T-width values.						
<b>LL475000 Series</b>											
LL475048	534.988 21.0625	48.420 1.9063	3.5 .14	31.08 kg 68.54 lb	*LL475010D	622.300 24.5000	73.025 2.8750	1.5 .06	12.00 kg 26.46 lb	101.600 4.0000	LL475010D : GROOVE IN OD CENTER HOLES IN OD CENTER
					*LL475011D	622.300 24.5000	82.550 3.2500	1.5 .06	13.91 kg 30.68 lb	111.125 4.3750	LL475011D : GROOVE IN OD CENTER HOLES IN OD CENTER
<b>L476500 Series</b>											
L476548	549.097 21.6180	80.962 3.1875	6.4 .25	46.09 kg 101.63 lb	L476510	692.150 27.2500	61.912 2.4375	6.4 .25	21.16 kg 46.66 lb	80.962 3.1875	L476510CD : GROOVE IN OD CENTER HOLES IN OD CENTER
L476549	549.275 21.6250	80.962 3.1875	6.4 .25	45.99 kg 101.42 lb	*L476510CD	692.150 27.2500	136.525 5.3750	1.5 .06	48.39 kg 106.69 lb	174.625 6.8750	L476518X : HOLES IN FRONTFACE SHOULDER ON OD BACKFACE
					*L476518X	720.000 28.3465	63.000 2.4803	1.5 .06	36.06 kg 79.51 lb	81.500 3.2087	
<b>480000 Series</b>											
*EE480181ADG	457.200 18.0000	368.300 14.5000	6.4 .25	- -	480340	863.498 33.9960	146.050 5.7500	6.4 .25	166.93 kg 368.08 lb	368.300 14.5000	EE480181ADG: GROOVE IN ID HOLES IN OD CENTER
EE480181D	457.200 18.0000	368.300 14.5000	6.4 .25	- -							
<b>L480200 Series</b>											
*L480249DGW	609.600 24.0000	180.975 7.1250	.8 .03	- -	*L480210X	787.400 31.0000	82.631 3.2532	1.5 .06	42.21 kg 93.08 lb	190.866 7.5144	L480249DGW: ASYMMETRICAL BEARING GROOVE IN ID SHOULDER ON ID RIGHTSIDE SLOTS IN LEFTFACE
					*L480210W	787.400 31.0000	68.240 2.6866	6.4 .25	31.97 kg 70.50 lb	162.082 6.3812	
											L480210W : SLOTS IN BACKFACE L480210X : SHOULDER ON OD BACKFACE
<b>LL480700 Series</b>											
LL480749	647.700 25.5000	38.100 1.5000	3.5 .14	13.80 kg 30.43 lb	*LL480710-B	736.600 29.0000	31.750 1.2500	3.3 .13	8.52 kg 18.78 lb	13.492 .5312	LL480710-B : CHAMFER ON FRONTFACE OD FLANGE ON OD FRONTFACE, BEARING WIDTH IS T1 DIMENSION
<b>LL481400 Series</b>											
LL481448	673.100 26.5000	61.912 2.4375	6.4 .25	35.99 kg 79.35 lb	LL481411	793.750 31.2500	49.212 1.9375	6.4 .25	16.27 kg 35.88 lb	66.675 2.6250	
<b>LL483400 Series</b>											
LL483448	759.925 29.9183	69.850 2.7500	3.3 .13	44.86 kg 98.93 lb	*LL483418XX	889.000 35.0000	50.800 2.0000	3.3 .13	23.57 kg 51.97 lb	69.849 2.7500	LL483448XX: MADE FROM VACUUM MELT STEEL
*LL483448XX	759.925 29.9183	69.850 2.7500	3.3 .13	44.86 kg 98.93 lb	LL483418	889.000 35.0000	50.800 2.0000	3.3 .13	23.57 kg 51.97 lb	69.849 2.7500	LL483449XX: MADE FROM VACUUM MELT STEEL
LL483449	762.000 30.0000	69.850 2.7500	3.3 .13	43.51 kg 95.94 lb							LL483418XX : MADE FROM VACUUM MELT STEEL
*LL483449XX	762.000 30.0000	69.850 2.7500	3.3 .13	43.51 kg 95.94 lb							
<b>L483900 Series</b>											
*L483943T	771.525 30.3750	92.075 3.6250	6.4 .25	- -	L483916	965.200 38.0000	61.912 2.4375	3.3 .13	37.99 kg 83.78 lb	92.075 3.6250	L483943T: REVERSE TAPERED BORE
<b>XR496000 Series</b>											
SEE CROSSED ROLLER BEARING SECTION											

8

<sup>1</sup>These Maximum Fillet Radii will be cleared by the Cone or Cup Radii.  
<sup>†</sup>Bore or O.D. shown are maximum dimensions. \*See Remarks Column.

LM501300 – LM508700 SERIES

CONE			Max Shaft Fillet Radii R <sup>**</sup>	Weight	CUP			Max H's'ng Fillet Radii r <sup>**</sup>	Weight	BEARING	Remarks
Number	BORE d	WIDTH B			Number	OUTSIDE DIA D	WIDTH C			WIDTH T	
<b>LM501300 Series</b>											
*LM501342DA	36.512 1.4375	77.732 3.0603	.8 .03	.95 kg 2.09 lb	LM501310	73.431 2.8910	14.732 .5800	.8 .03	.11 kg .24 lb	38.895 1.5313	LM501330-SD: EXTENDED SMALL RIB SQUARE BORE
*LM501345DA	38.100 1.5000	77.732 3.0603	.8 .03	.89 kg 1.96 lb	LM501310A	73.431 2.8910	14.732 .5800	1.5 .06	.11 kg .24 lb	38.895 1.5313	LM501334-SD: EXTENDED SMALL RIB SQUARE BORE
					LM501310P	73.431 2.8910	14.732 .5800	.8 .03	.11 kg .24 lb	38.895 1.5313	LM501342DA: ASYMMETRICAL BEARING HOLES IN OD LEFTFACE
					LM501311	73.431 2.8910	18.186 .7160	2.3 .09	.14 kg .31 lb	45.804 1.8033	
					LM501314	73.431 2.8910	16.604 .6537	.8 .03	.13 kg .28 lb	42.639 1.6787	LM501345DA: ASYMMETRICAL BEARING HOLES IN OD LEFTFACE
LM501349	41.275 1.6250	19.812 .7800	3.5 .14	.23 kg .50 lb	LM501310	73.431 2.8910	14.732 .5800	.8 .03	.11 kg .24 lb	19.558 .7700	
LM501349A	41.275 1.6250	19.812 .7800	.8 .03	.22 kg .49 lb	LM501310A	73.431 2.8910	14.732 .5800	1.5 .06	.11 kg .24 lb	19.558 .7700	
LM501349HP	41.275 1.6250	19.812 .7800	3.5 .14	.23 kg .50 lb	LM501310P	73.431 2.8910	14.732 .5800	.8 .03	.11 kg .24 lb	19.558 .7700	
					LM501311	73.431 2.8910	18.186 .7160	2.3 .09	.14 kg .31 lb	23.012 .9060	
					LM501314	73.431 2.8910	16.604 .6537	.8 .03	.13 kg .28 lb	21.430 .8437	
*LM501330-SD	40.589 1.5980	73.025 2.8750	-	.96 kg 2.11 lb	LM501330-SD and grouped cones may be paired with all single cups corresponding to LM501342DA and will require 2.380 mm (.0937 in) to be added to the T-width values.						
*LM501334-SD	42.862 1.6875	73.025 2.8750	-	.86 kg 1.90 lb							
<b>LM503300 Series</b>											
*LM503349	45.987 1.8105	18.000 .7087	2.3 .09	.21 kg .46 lb	LM503310	74.976 2.9518	14.000 .5512	1.5 .06	.09 kg .21 lb	18.000 .7087	LM503349: FRONTFACE CHAMFER
*LM503349A	45.987 1.8105	18.000 .7087	spcl. spcl.	.20 kg .44 lb	LM503310P	74.976 2.9518	14.000 .5512	1.5 .06	.09 kg .21 lb	18.000 .7087	LM503349A: FRONTFACE CHAMFER SPECIAL BACKFACE RADIUS
*LM503349P	45.987 1.8105	18.000 .7087	2.3 .09	.21 kg .46 lb	†JLM503319	85.000 3.3465	14.000 .5512	.5 .01	.24 kg .52 lb	18.000 .7087	LM503349P: FRONTFACE CHAMFER
<b>HH506300 Series</b>											
HH506348	49.212 1.9375	44.450 1.7500	3.5 .14	1.51 kg 3.33 lb	HH506310	114.300 4.5000	36.068 1.4200	3.3 .13	.83 kg 1.83 lb	44.450 1.7500	
HH506349	49.987 1.9680	44.450 1.7500	3.5 .14	1.49 kg 3.28 lb	HH506311	114.300 4.5000	36.068 1.4200	.8 .03	.85 kg 1.86 lb	44.450 1.7500	
<b>LM506800 Series</b>											
†JLM506848E	55.000 2.1654	26.000 1.0236	3.5 .14	.37 kg .82 lb	†JLM506810	90.000 3.5433	18.500 .7283	.5 .02	.18 kg .41 lb	23.000 .9055	JLM506849V: MADE FROM VACUUM MELT STEEL
†JLM506849	55.000 2.1654	23.000 .9055	1.5 .06	.36 kg .80 lb	†JLM506810V	90.000 3.5433	18.500 .7283	.5 .02	.18 kg .41 lb	23.000 .9055	
†JLM506849A	55.000 2.1654	23.000 .9055	3.5 .14	.36 kg .79 lb	LM506810A	88.900 3.5000	18.500 .7283	.5 .02	.16 kg .36 lb	23.000 .9055	
*†JLM506849V	55.000 2.1654	23.000 .9055	1.5 .06	.36 kg .80 lb	†JLM506811	90.000 3.5433	20.500 .8071	.5 .02	.22 kg .48 lb	25.000 .9843	
					†JLM506812	90.000 3.5433	21.331 .8398	.5 .02	.23 kg .51 lb	25.832 1.0170	
<b>L507900 Series</b>											
L507945	53.975 2.1250	18.258 .7188	1.5 .06	.30 kg .67 lb	L507910	87.312 3.4375	14.288 .5625	1.5 .06	.13 kg .29 lb	18.258 .7188	L507949XX: MADE FROM VACUUM MELT STEEL
L507949	57.150 2.2500	18.258 .7188	1.5 .06	.26 kg .58 lb	*L507910-B	87.312 3.4375	14.288 .5625	-	.14 kg .32 lb	7.145 .2813	L507910-B: FLANGE ON OD FRONTFACE, BEARING WIDTH IS T1 DIMENSION
*L507949XX	57.150 2.2500	18.258 .7188	1.5 .06	.26 kg .58 lb	*L507910XX	87.312 3.4375	14.288 .5625	1.5 .06	.13 kg .29 lb	18.258 .7188	L507910XX: MADE FROM VACUUM MELT STEEL
					L507913	88.900 3.5000	15.080 .5937	1.5 .06	.17 kg .37 lb	19.050 .7500	L507914D: GROOVE IN OD CENTER HOLES IN OD CENTER
					*L507914D	92.075 3.6250	34.130 1.3437	.8 .03	.55 kg 1.20 lb	42.070 1.6563	L507914DC: GROOVE IN OD CENTER HOLES IN OD CENTER
					*L507914DC	92.075 3.6250	34.130 1.3437	.8 .03	.55 kg 1.20 lb	42.070 1.6563	
<b>LM508700 Series</b>											
†JLM508748	60.000 2.3622	24.000 .9449	5.0 .20	.39 kg .86 lb	†JLM508710	95.000 3.7402	19.000 .7480	2.5 .10	.20 kg .44 lb	24.000 .9449	

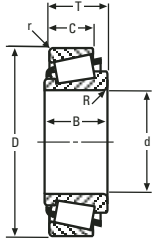

SINGLE ROW

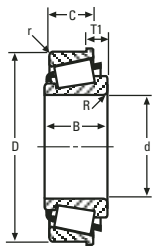

SINGLE ROW WITH FLANGE

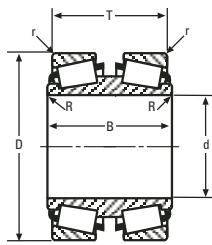

DOUBLE CONE

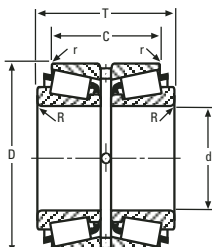

DOUBLE CUP

LL510700 SERIES CONTINUED ON NEXT PAGE

\*\*These Maximum Fillet Radii will be cleared by the Cone or Cup Radii.  
†Bore or O.D. shown are maximum dimensions. \*See Remarks Column.

LL510700 – HM518400 SERIES

CONE			Max Shaft Fillet Radii R''	Weight	CUP			Max Hs'ng Fillet Radii r''	Weight	BEARING	Remarks
Number	BORE d	WIDTH B			Number	OUTSIDE DIA D	WIDTH C			WIDTH T	
LL510700 Series											
*LL510749	63.500 2.5000	12.700 .5000	1.6 .06	.19 kg .41 lb	LL510710	92.075 3.6250	9.525 .3750	1.5 .06	.08 kg .17 lb	13.495 .5313	LL510749: FRONTFACE CHAMFER
M511900 Series											
*†JM511945	65.000 2.5591	30.000 1.1811	3.0 .12	.74 kg 1.63 lb	3920	112.712 4.4375	23.812 .9375	3.3 .13	.44 kg .98 lb	29.020 1.1425	JM511945: EXTENDED SMALL RIB
†JM511946	65.000 2.5591	28.000 1.1024	3.0 .12	.72 kg 1.58 lb	†JM511910	110.000 4.3307	22.500 .8858	2.5 .10	.33 kg .74 lb	28.000 1.1024	
HM513600 Series											
†JHM513640	63.500 2.5000	33.937 1.3361	6.5 .26	1.44 kg 3.17 lb	†JHM513615	130.000 5.1181	28.000 1.1024	3.5 .14	.63 kg 1.40 lb	36.937 1.4542	
514000 Series											
EE514045	114.300 4.5000	82.550 3.2500	6.4 .25	14.96 kg 32.99 lb	514110	279.400 11.0000	53.975 2.1250	6.4 .25	8.35 kg 18.42 lb	82.550 3.2500	
EE514050	127.000 5.0000	82.550 3.2500	6.4 .25	13.40 kg 29.55 lb							
M514500 Series											
*M514546	73.025 2.8750	39.370 1.5500	2.8 .11	1.01 kg 2.23 lb	M514512	123.825 4.8750	26.187 1.0310	2.0 .08	.47 kg 1.04 lb	38.887 1.5310	M514546: BACKFACE CHAMFER BROKEN FRONTFACE ID EXTENDED LARGE RIB
HM515200 Series											
HM515230	50.800 2.0000	34.925 1.3750	3.5 .14	1.99 kg 4.39 lb	*HM515210-B	130.175 5.1250	31.750 1.2500	3.3 .13	.76 kg 1.68 lb	12.700 .5000	HM515210-B : FLANGE ON OD FRONTFACE, BEARING WIDTH IS T1 DIMENSION
M515600 Series											
†JM515649	80.000 3.1496	34.000 1.3386	3.0 .12	1.14 kg 2.50 lb	†JM515610	130.000 5.1181	28.500 1.1220	2.5 .10	.57 kg 1.26 lb	35.000 1.3780	
†JM515648	80.000 3.1496	42.500 1.6732	3.0 .12	- -	JM515648 may be paired with all single cups corresponding to JM515649 and will require 3.000 mm (.1181 in) to be added to the T-width values.						
HM515700 Series											
HM515745	76.200 3.0000	46.100 1.8150	3.5 .14	1.80 kg 3.98 lb	HM515714	140.000 5.5118	33.338 1.3125	3.3 .13	.94 kg 2.08 lb	44.450 1.7500	HM515716-B : FLANGE ON OD FRONTFACE, BEARING WIDTH IS T1 DIMENSION
HM515749	79.375 3.1250	46.100 1.8150	3.5 .14	1.66 kg 3.67 lb	*HM515716-B	142.138 5.5960	33.338 1.3125	3.3 .13	- -	18.250 .7185	
					HM515716	142.138 5.5960	33.338 1.3125	3.3 .13	1.06 kg 2.35 lb	44.450 1.7500	
HM515737	70.000 2.7559	44.653 1.7580	3.0 .12	2.01 kg 4.43 lb	HM515737 may be paired with all single cups corresponding to HM515745 and will require -1.448 mm (-.0570 in) to be added to the T-width values.						
HM515741	73.025 2.8750	52.451 2.0650	5.0 .20	2.16 kg 4.76 lb	HM515741 and grouped cones may be paired with all single cups corresponding to HM515745 and will require 6.350 mm (.2500 in) to be added to the T-width values.						
HM515745A	76.200 3.0000	52.451 2.0650	3.5 .14	2.02 kg 4.45 lb							
HM516400 Series											
HM516442	76.200 3.0000	39.688 1.5625	3.5 .14	1.66 kg 3.65 lb	HM516410A	133.350 5.2500	32.545 1.2813	.8 .03	.77 kg 1.71 lb	39.687 1.5625	HM516414-B : FLANGE ON OD FRONTFACE, BEARING WIDTH IS T1 DIMENSION
HM516447	80.962 3.1875	39.688 1.5625	3.5 .14	1.47 kg 3.25 lb	HM516410	133.350 5.2500	32.545 1.2813	3.3 .13	.76 kg 1.68 lb	39.687 1.5625	
HM516448	82.550 3.2500	39.688 1.5625	6.8 .27	1.39 kg 3.08 lb	*HM516414-B	136.525 5.3750	32.545 1.2813	1.5 .06	1.03 kg 2.27 lb	12.319 .4850	
HM516449A	82.550 3.2500	39.688 1.5625	6.2 .25	1.35 kg 2.98 lb							
HM516449C	82.550 3.2500	39.688 1.5625	3.5 .14	1.40 kg 3.09 lb							
HM516800 Series											
†JHM516849	85.000 3.3465	38.000 1.4961	3.0 .12	1.51 kg 3.32 lb	†JHM516810	140.000 5.5118	31.500 1.2402	2.5 .10	.76 kg 1.67 lb	39.000 1.5354	
517000 Series											
EE517060D	152.400 6.0000	111.125 4.3750	3.3 .13	28.00 kg 61.73 lb	517117	298.450 11.7500	44.450 1.7500	3.3 .13	5.41 kg 11.92 lb	107.949 4.2500	
HM518400 Series											
HM518445	88.900 3.5000	39.688 1.5625	6.4 .25	2.05 kg 4.52 lb	HM518410	152.400 6.0000	30.162 1.1875	3.3 .13	.76 kg 1.68 lb	39.688 1.5625	

†These Maximum Fillet Radii will be cleared by the Cone or Cup Radii.  
†Bore or O.D. shown are maximum dimensions. \*See Remarks Column.

520000 – HM522600 SERIES

CONE			Max Shaft Fillet Radii R <sup>**</sup>	Weight	CUP			Max H's'ng Fillet Radii r <sup>**</sup>	Weight	BEAR-ING	Remarks
Number	BORE d	WIDTH B			Number	OUTSIDE DIA D	WIDTH C			WIDTH T	
<b>520000 Series</b>											
EE522102	533.400 21.0000	82.550 3.2500	6.4 .25	-	523087	784.225 30.8750	53.975 2.1250	6.4 .25	33.25 kg 73.32 lb	88.900 3.5000	523088D : GROOVE IN OD CENTER HOLES IN OD CENTER
					523088XD	784.225 30.8750	120.650 4.7500	1.5 .06	-	190.500 7.5000	523088DC : HOLES IN OD CENTER
					*523088DC	784.225 30.8750	120.650 4.7500	1.5 .06	79.03 kg 174.26 lb	190.500 7.5000	
					*523088D	784.225 30.8750	120.650 4.7500	1.5 .06	79.03 kg 174.26 lb	190.500 7.5000	
					523087	784.225 30.8750	53.975 2.1250	6.4 .25	33.25 kg 73.32 lb	165.100 6.5000	
EE522126D	539.750 21.2500	161.925 6.3750	3.3 .13	-	523087	784.225 30.8750	53.975 2.1250	6.4 .25	33.25 kg 73.32 lb	165.100 6.5000	
<b>LM520300 Series</b>											
LM520349	101.600 4.0000	21.717 .8550	1.5 .06	1.57 kg 3.47 lb	*LM520310D	146.050 5.7500	38.895 1.5313	.8 .03	.78 kg 1.72 lb	49.209 1.9374	LM520310D : GROOVE IN OD CENTER HOLES IN OD CENTER
<b>LL521800 Series</b>											
LL521845	104.775 4.1250	15.083 .5938	1.6 .06	.50 kg 1.10 lb	LL521810	142.083 5.5938	11.908 .4688	1.5 .06	.18 kg .40 lb	15.875 .6250	
LL521849C	107.950 4.2500	15.083 .5938	1.6 .06	.44 kg .96 lb	LL521811	142.083 5.5938	11.908 .4688	1.5 .06	.18 kg .40 lb	15.875 .6250	
<b>L521900 Series</b>											
L521945	101.600 4.0000	21.433 .8438	1.5 .06	.83 kg 1.84 lb	L521910	146.050 5.7500	16.670 .6563	1.5 .06	.33 kg .74 lb	21.432 .8438	L521949DE: ASYMMETRICAL BEARING
L521948	107.874 4.2470	21.433 .8438	1.5 .06	.66 kg 1.45 lb	*L521910DE	146.050 5.7500	53.975 2.1250	.8 .03	1.18 kg 2.60 lb	63.500 2.5000	L521910D : GROOVE IN OD CENTER HOLES IN OD CENTER
L521949	107.950 4.2500	21.433 .8438	1.5 .06	.66 kg 1.45 lb	*L521910DC	146.050 5.7500	39.688 1.5625	.8 .03	.83 kg 1.82 lb	49.212 1.9375	L521910DC : HOLES IN OD CENTER
					*L521910D	146.050 5.7500	39.688 1.5625	.8 .03	.83 kg 1.82 lb	49.212 1.9375	L521910DE : GROOVE IN OD CENTER HOLES IN OD CENTER
					L521914	152.400 6.0000	16.670 .6563	1.5 .06	.53 kg 1.16 lb	21.432 .8438	
*L521949DE	107.950 4.2500	50.008 1.9688	1.5 .06	1.85 kg 4.08 lb	L521910	146.050 5.7500	16.670 .6563	1.5 .06	.33 kg .74 lb	42.865 1.6876	
					L521914	152.400 6.0000	16.670 .6563	1.5 .06	.53 kg 1.16 lb	42.865 1.6876	
<b>L522100 Series</b>											
*L522148WV	110.400 4.3465	21.000 .8268	1.5 .06	.64 kg 1.41 lb	*L522110V	146.000 5.7480	17.000 .6693	1.5 .06	.30 kg .67 lb	21.420 .8433	L522148WV: MADE FROM VACUUM MELT STEEL L522110V : MADE FROM VACUUM MELT STEEL
<b>LM522500 Series</b>											
*LM522543DA	100.012 3.9375	127.757 5.0298	.8 .03	6.64 kg 14.64 lb	LM522510	159.987 6.2987	26.988 1.0625	3.3 .13	.75 kg 1.66 lb	69.058 2.7188	LM522543DA: ASYMMETRICAL BEARING HOLES IN OD LEFTFACE
*LM522544DA	101.600 4.0000	127.757 5.0298	.8 .03	6.38 kg 14.07 lb	LM522518	164.737 6.4857	32.131 1.2650	2.3 .09	1.22 kg 2.68 lb	73.832 2.9068	LM522544DA: ASYMMETRICAL BEARING HOLES IN OD LEFTFACE LM522510D : GROOVE IN OD CENTER HOLES IN OD CENTER
LM522546	107.950 4.2500	34.925 1.3750	3.5 .14	1.61 kg 3.55 lb	LM522510	159.987 6.2987	26.988 1.0625	3.3 .13	.75 kg 1.66 lb	34.925 1.3750	
LM522548	109.987 4.3302	34.925 1.3750	8.0 .31	1.44 kg 3.19 lb	*LM522510DC	159.987 6.2987	58.738 2.3125	.8 .03	1.81 kg 4.00 lb	74.613 2.9375	LM522510DC : HOLES IN OD CENTER
LM522549	109.987 4.3302	34.925 1.3750	3.5 .14	1.52 kg 3.34 lb	*LM522510D	159.987 6.2987	58.738 2.3125	.8 .03	1.81 kg 4.00 lb	74.613 2.9375	
LM522549H	109.987 4.3302	34.925 1.3750	3.5 .14	1.56 kg 3.44 lb	LM522518	164.737 6.4857	32.131 1.2650	2.3 .09	1.22 kg 2.68 lb	37.312 1.4690	
LM522549W	109.987 4.3302	34.925 1.3750	3.5 .14	1.53 kg 3.36 lb							
<b>HM522600 Series</b>											
†JHM522649	110.000 4.3307	46.000 1.8110	3.0 .12	3.05 kg 6.72 lb	†JHM522610	180.000 7.0866	38.000 1.4961	2.5 .10	1.49 kg 3.30 lb	47.000 1.8504	
†JHM522649A	110.000 4.3307	46.000 1.8110	7.0 .28	3.04 kg 6.70 lb							
†JHM522649C	110.000 4.3307	46.000 1.8110	3.0 .12	3.02 kg 6.66 lb							

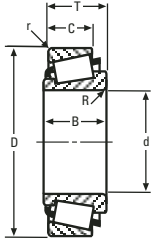

SINGLE ROW

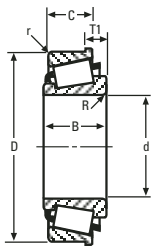

SINGLE ROW WITH FLANGE

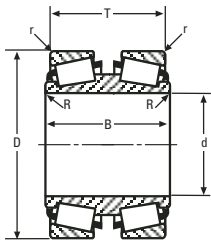

DOUBLE CONE

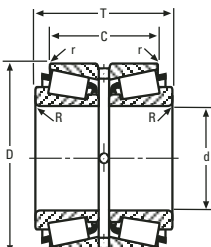

DOUBLE CUP

525000 SERIES CONTINUED ON NEXT PAGE

\*\*These Maximum Fillet Radii will be cleared by the Cone or Cup Radii.  
†Bore or O.D. shown are maximum dimensions. \*See Remarks Column.

525000 – HM535300 SERIES

CONE			Max Shaft Fillet Radii R''	Weight	CUP			Max Hs'ng Fillet Radii r''	Weight	BEARING	Remarks
Number	BORE d	WIDTH B			Number	OUTSIDE DIA D	WIDTH C			WIDTH T	
<b>525000 Series</b>											
EE525183D	457.200	342.900	9.5	-	525320	812.800	142.875	6.4	130.86 kg	342.900	EE525185D: GROOVE IN ID CENTER INVERTED BEARING
	18.0000	13.5000	.38			32.0000	5.6250	.25	288.55 lb	13.5000	
					*525321	812.800	139.700	1.3	125.17 kg	323.850	525321 : CHAMFER ON BACKFACE OD SHOULDER ON OD BACKFACE
						32.0000	5.5000	.05	276.01 lb	12.7500	
*EE525185D	457.200	431.800	6.4	-	EE525185D may be paired with all single cups corresponding to EE525183D and will require 3.175 mm (.1250 in) to be added to the T-width values.						
	18.0000	17.0000	.25	-							
<b>526000 Series</b>											
EE526130	330.200	80.167	6.4	30.12 kg	*526190-B	482.600	60.325	3.3	16.59 kg	41.275	EE526130H: NO SMALL RIB SHOULDER ON OD FRONTFACE
	13.0000	3.1562	.25	66.42 lb		19.0000	2.3750	.13	36.57 lb	1.6250	
*EE526130H	330.200	80.167	6.4	32.09 kg	526190	482.600	60.325	3.3	15.09 kg	85.725	526190-B : FLANGE ON OD FRONTFACE, BEARING WIDTH IS T1 DIMENSION
	13.0000	3.1562	.25	70.75 lb		19.0000	2.3750	.13	33.28 lb	3.3750	
EE526132	330.200	80.167	3.3	30.25 kg	*526191DC	482.600	127.000	1.5	33.02 kg	177.800	526191CD : GROOVE IN OD CENTER HOLES IN OD CENTER
	13.0000	3.1562	.13	66.69 lb		19.0000	5.0000	.06	72.80 lb	7.0000	
					*526191D	482.600	127.000	1.5	32.89 kg	177.800	526191D : GROOVE IN OD CENTER HOLES IN OD CENTER
					19.0000	5.0000	.06	72.53 lb	7.0000		
					*526191CD	482.600	127.000	1.5	30.69 kg	177.800	526191DC : HOLES IN OD CENTER
					19.0000	5.0000	.06	67.67 lb	7.0000		
EE526131D	330.200	147.638	1.5	68.24 kg	526190	482.600	60.325	3.3	15.09 kg	152.400	EE528300D: HOLES IN OD CENTER
	13.0000	5.8125	.06	150.46 lb		19.0000	2.3750	.13	33.28 lb	6.0000	
<b>528000 Series</b>											
*EE528300D	762.000	387.350	6.4	-	528480	1219.200	165.100	12.7	274.33 kg	396.875	
	30.0000	15.2500	.25	-		48.0000	6.5000	.50	604.90 lb	15.6250	
<b>529000 Series</b>											
EE529090DW	228.600	139.700	3.3	59.67 kg	529157	400.050	57.150	3.3	12.80 kg	139.700	
	9.0000	5.5000	.13	131.56 lb		15.7500	2.2500	.13	28.23 lb	5.5000	
EE529091D	228.600	139.700	3.3	59.75 kg							
	9.0000	5.5000	.13	131.76 lb							
<b>LL529700 Series</b>											
LL529749	146.050	20.638	1.5	.94 kg	LL529710	188.120	16.670	1.5	.45 kg	22.225	
	5.7500	.8125	.06	2.08 lb		7.4063	.6563	.06	1.00 lb	.8750	
					LL529711	188.120	16.670	3.3	.43 kg	22.225	
						7.4063	.6563	.13	.96 lb	.8750	
<b>530000 Series</b>											
EE533000D	762.000	234.950	6.4	-	534250	1079.500	85.725	6.4	109.63 kg	238.125	
	30.0000	9.2500	.25	-		42.5000	3.3750	.25	241.73 lb	9.3750	
<b>531000 Series</b>											
EE531201D	508.000	219.075	6.4	-	531300	762.000	85.725	6.4	50.95 kg	219.075	
	20.0000	8.6250	.25	-		30.0000	3.3750	.25	112.35 lb	8.6250	
<b>HM531900 Series</b>											
HM531936DD	139.700	158.750	1.5	28.53 kg	HM531911	260.350	46.038	3.3	3.63 kg	149.225	
	5.5000	6.2500	.06	62.90 lb		10.2500	1.8125	.13	8.01 lb	5.8750	
HM531948DD	152.400	158.750	1.5	24.90 kg	HM531918	266.700	46.038	3.3	4.47 kg	149.225	
	6.0000	6.2500	.06	54.90 lb		10.5000	1.8125	.13	9.85 lb	5.8750	
<b>M533300 Series</b>											
M533349-S	165.100	44.000	3.5	3.83 kg	M533310	231.976	36.000	3.5	1.70 kg	45.000	
	6.5000	1.7323	.14	8.45 lb		9.1329	1.4173	.14	3.75 lb	1.7717	
<b>HM534100 Series</b>											
†JHM534149	170.000	38.000	3.0	3.04 kg	†JHM534110	230.000	31.000	2.5	1.28 kg	39.000	
	6.6929	1.4961	.12	6.70 lb		9.0551	1.2205	.10	2.82 lb	1.5354	
<b>HM535300 Series</b>											
HM535347	169.974	66.675	3.5	8.49 kg	*HM535310-B	260.350	52.388	3.3	4.74 kg	25.400	HM535310-B : FLANGE ON OD FRONTFACE, BEARING WIDTH IS T1 DIMENSION
	6.6919	2.6250	.14	18.72 lb		10.2500	2.0625	.13	10.45 lb	1.0000	
HM535349	171.450	66.675	3.5	8.23 kg	HM535310	260.350	52.388	3.3	4.18 kg	66.675	
	6.7500	2.6250	.14	18.15 lb		10.2500	2.0625	.13	9.23 lb	2.6250	
HM535349A	171.450	73.025	3.5	8.39 kg							
	6.7500	2.8750	.14	18.50 lb							
HM535348D	171.450	127.000	1.5	20.29 kg	HM535310	260.350	52.388	3.3	4.18 kg	127.000	
	6.7500	5.0000	.06	44.74 lb		10.2500	2.0625	.13	9.23 lb	5.0000	

†These Maximum Fillet Radii will be cleared by the Cone or Cup Radii.  
†Bore or O.D. shown are maximum dimensions. \*See Remarks Column.

536000 SERIES CONTINUED ON NEXT PAGE



536000 – 545000 SERIES

CONE			Max Shaft Fillet Radii R <sup>**</sup>	Weight	CUP			Max Hs'ng Fillet Radii r <sup>**</sup>	Weight	BEARING WIDTH T	Remarks
Number	BORE d	WIDTH B			Number	OUTSIDE DIA D	WIDTH C				
<b>536000 Series</b>											
EE536136D	342.900 13.5000	163.512 6.4375	3.3 .13	- -	536225	571.500 22.5000	63.500 2.5000	6.4 .25	22.53 kg 49.68 lb	163.513 6.4375	
<b>537000 Series</b>											
NA537075	190.500 7.5000	33.338 1.3125	3.5 .14	- -	*537103DC	260.350 10.2500	50.800 2.0000	.8 .03	3.56 kg 7.86 lb	66.675 2.6250	537103D : GROOVE IN OD CENTER HOLES IN OD CENTER
					*537103D	260.350 10.2500	50.800 2.0000	.8 .03	3.56 kg 7.86 lb	66.675 2.6250	537103DC : HOLES IN OD CENTER
<b>LL537600 Series</b>											
LL537649	184.150 7.2500	25.400 1.0000	1.5 .06	1.82 kg 4.01 lb	LL537610	236.538 9.3125	19.050 .7500	1.5 .06	.79 kg 1.74 lb	26.193 1.0312	LL537610D : GROOVE IN OD CENTER HOLES IN OD CENTER
					*LL537610D	236.538 9.3125	41.275 1.6250	.8 .03	1.72 kg 3.80 lb	55.560 2.1874	
<b>538000 Series</b>											
EE538260	660.400 26.0000	127.000 5.0000	6.4 .25	- -	538370	939.800 37.0000	98.425 3.8750	6.4 .25	89.05 kg 196.36 lb	136.525 5.3750	EE538261 : HOLES IN BACKFACE
*EE538261	660.400 26.0000	127.000 5.0000	6.4 .25	- -							
<b>540000 Series</b>											
EE540502	127.000 5.0000	87.312 3.4375	13.5 .53	18.32 kg 40.39 lb	541162	295.275 11.6250	57.150 2.2500	6.4 .25	8.76 kg 19.31 lb	82.553 3.2501	
EE540550	139.700 5.5000	87.312 3.4375	9.7 .38	16.50 kg 36.37 lb							
540901D	127.000 5.0000	158.750 6.2500	13.2 .52	44.50 kg 98.12 lb	541162	295.275 11.6250	57.150 2.2500	6.4 .25	8.76 kg 19.31 lb	149.225 5.8750	
<b>L540000 Series</b>											
L540048	200.000 7.8740	27.783 1.0938	1.5 .06	2.15 kg 4.74 lb	L540010	254.000 10.0000	21.433 .8438	1.5 .06	1.02 kg 2.24 lb	28.575 1.1250	L540010D : GROOVE IN OD CENTER HOLES IN OD CENTER
L540049	196.850 7.7500	27.783 1.0938	1.5 .06	2.34 kg 5.17 lb	*L540010DC	254.000 10.0000	47.625 1.8750	.8 .03	2.36 kg 5.20 lb	61.909 2.4374	L540010DC : HOLES IN OD CENTER
					*L540010D	254.000 10.0000	47.625 1.8750	.8 .03	2.36 kg 5.20 lb	61.909 2.4374	
L540049D	196.850 7.7500	52.390 2.0626	1.6 .06	5.58 kg 12.30 lb	L540010	254.000 10.0000	21.433 .8438	1.5 .06	1.02 kg 2.24 lb	53.974 2.1250	
<b>M541300 Series</b>											
M541349	203.200 8.0000	49.212 1.9375	3.5 .14	- -	*M541310CD	292.100 11.5000	84.138 3.3125	.8 .03	6.58 kg 14.52 lb	109.537 4.3125	M541310CD : GROOVE IN OD CENTER HOLES IN OD CENTER
<b>542000 Series</b>											
EE542215	546.100 21.5000	76.200 3.0000	6.4 .25	63.69 kg 140.45 lb	542290	736.600 29.0000	50.800 2.0000	6.4 .25	21.32 kg 47.01 lb	76.200 3.0000	542291CD : GROOVE IN OD CENTER HOLES IN OD CENTER
EE542220	558.800 22.0000	76.200 3.0000	6.4 .25	57.11 kg 125.93 lb	*542291CD	736.600 29.0000	114.300 4.5000	3.3 .13	48.65 kg 107.28 lb	165.100 6.5000	
<b>HM542900 Series</b>											
HM542948	203.200 8.0000	80.962 3.1875	1.5 .06	- -	HM542911	346.075 13.6250	60.325 2.3750	3.3 .13	9.72 kg 21.44 lb	79.375 3.1250	
<b>543000 Series</b>											
543085	215.900 8.5000	31.750 1.2500	3.5 .14	3.82 kg 8.42 lb	543114	290.010 11.4177	22.225 .8750	3.3 .13	1.71 kg 3.78 lb	31.750 1.2500	543085-SA : HOLES IN BACKFACE TO UNDERCUT
*543085-SA	215.900 8.5000	31.750 1.2500	3.5 .14	3.91 kg 8.62 lb	*543115DC	287.338 11.3125	50.800 2.0000	.8 .03	3.97 kg 8.76 lb	69.850 2.7500	543115D : GROOVE IN OD CENTER HOLES IN OD CENTER
543086	219.969 8.6602	31.750 1.2500	3.5 .14	3.47 kg 7.66 lb	*543115D	287.338 11.3125	50.800 2.0000	.8 .03	3.79 kg 8.36 lb	69.850 2.7500	543115DC : HOLES IN OD CENTER
					543116	292.009 11.4964	22.225 .8750	3.3 .13	1.87 kg 4.13 lb	31.750 1.2500	
<b>544000 Series</b>											
544090	228.600 9.0000	31.750 1.2500	3.5 .14	3.71 kg 8.19 lb	544116	295.275 11.6250	23.812 .9375	3.3 .13	1.45 kg 3.20 lb	33.337 1.3125	
544091	231.775 9.1250	31.750 1.2500	3.5 .14	3.43 kg 7.56 lb	544118	300.038 11.8125	23.812 .9375	3.3 .13	1.87 kg 4.11 lb	33.337 1.3125	
<b>545000 Series</b>											
545112	285.750 11.2500	31.750 1.2500	3.5 .14	4.58 kg 10.10 lb	545139	354.012 13.9375	22.225 .8750	3.3 .13	1.84 kg 4.05 lb	33.337 1.3125	545142CD : GROOVE IN OD CENTER HOLES IN OD CENTER

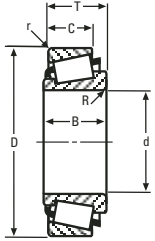

SINGLE ROW

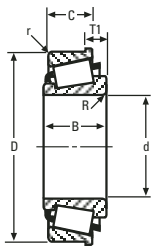

SINGLE ROW WITH FLANGE

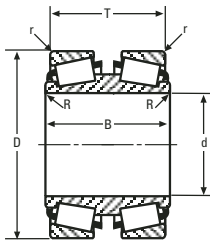

DOUBLE CONE

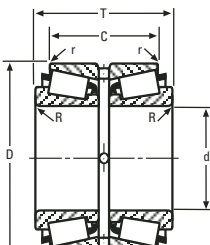

DOUBLE CUP

545000 SERIES CONTINUED ON NEXT PAGE

\*\*These Maximum Fillet Radii will be cleared by the Cone or Cup Radii.  
†Bore or O.D. shown are maximum dimensions. \*See Remarks Column.



CONE			Max Shaft Fillet Radii R''	Weight	CUP			Max Hs'ng Fillet Radii r''	Weight	BEAR-ING	Remarks
Number	BORE d	WIDTH B			Number	OUTSIDE DIA D	WIDTH C			WIDTH T	
545000 Series (cont)											
					545141	358.775	22.225	3.3	2.30 kg	33.337	
						14.1250	.8750	.13	5.07 lb	1.3125	
					*545142CD	358.775	53.975	1.5	5.69 kg	76.200	
						14.1250	2.1250	.06	12.54 lb	3.0000	
LM545800 Series											
LM545847	235.077	53.975	3.5	7.34 kg	LM545810	314.325	36.512	3.3	2.80 kg	49.212	LM545849V: MADE FROM VACUUM MELT STEEL
	9.2550	2.1250	.14	16.19 lb		12.3750	1.4375	.13	6.17 lb	1.9375	
LM545848	234.848	53.975	3.5	7.38 kg	*LM545810-B	314.325	36.512	3.3	3.59 kg	20.955	LM545810-B : FLANGE ON OD FRONTFACE, BEARING WIDTH IS TI DIMENSION
	9.2460	2.1250	.14	16.27 lb		12.3750	1.4375	.13	7.91 lb	.8250	
LM545849	234.950	49.212	3.5	6.99 kg	*LM545810V	314.325	36.512	3.3	2.80 kg	49.212	LM545810V : MADE FROM VACUUM MELT STEEL
	9.2500	1.9375	.14	15.42 lb		12.3750	1.4375	.13	6.17 lb	1.9375	
LM545849A	234.950	49.212	6.4	7.06 kg	LM545812	317.500	36.512	3.3	3.25 kg	49.212	
	9.2500	1.9375	.25	15.57 lb		12.5000	1.4375	.13	7.16 lb	1.9375	
LM545849E	234.950	53.975	3.5	7.38 kg							
	9.2500	2.1250	.14	16.27 lb							
*LM545849V	234.950	49.212	3.5	7.25 kg							
	9.2500	1.9375	.14	15.99 lb							
546000 Series											
EE546220D	558.673	442.912	6.4	-	546355	901.573	190.500	12.7	185.67 kg	457.200	
	21.9950	17.4375	.25	-		35.4950	7.5000	.50	409.40 lb	18.0000	
EE546220DH	558.673	442.912	6.4	-							
	21.9950	17.4375	.25	-							
547000 Series											
*EE547341D	863.600	425.450	4.8	-	547480	1219.200	187.325	12.7	263.71 kg	438.149	EE547341D: HOLES IN OD CENTER
	34.0000	16.7500	.19	-		48.0000	7.3750	.50	581.47 lb	17.2500	
M552800 Series											
M552849D	269.875	130.175	1.5	41.08 kg	M552810	392.100	47.625	3.3	7.24 kg	130.175	
	10.6250	5.1250	.06	90.58 lb		15.4370	1.8750	.13	15.97 lb	5.1250	
L555200 Series											
*†JL555235	SEE HYDRA-RIB SECTION				†JL555219HR	SEE HYDRA-RIB SECTION					
*†JL555239	SEE HYDRA-RIB SECTION					SEE HYDRA-RIB SECTION					
L555233	279.400	47.625	3.5	10.51 kg	L555210	374.650	34.925	3.3	3.51 kg	47.625	L555210D : GROOVE IN OD CENTER
	11.0000	1.8750	.14	23.17 lb		14.7500	1.3750	.13	7.75 lb	1.8750	HOLES IN OD CENTER
L555249	292.100	47.625	3.5	8.38 kg	*L555210DC	374.650	79.375	1.5	6.98 kg	104.775	L555210DC : HOLES IN OD CENTER
	11.5000	1.8750	.14	18.48 lb		14.7500	3.1250	.06	15.38 lb	4.1250	
					*L555210D	374.650	79.375	1.5	6.49 kg	104.775	
						14.7500	3.1250	.06	14.32 lb	4.1250	
L558500 Series											
L558548	320.675	55.562	3.3	-	L558510	406.400	38.100	3.3	4.17 kg	50.800	
	12.6250	2.1875	.13	-		16.0000	1.5000	.13	9.19 lb	2.0000	
LM559000 Series											
LM559048	323.850	63.500	3.3	-	LM559010	422.275	44.450	3.3	5.75 kg	58.738	
	12.7500	2.5000	.13	-		16.6250	1.7500	.13	12.67 lb	2.3125	
560000 Series											
EE560592	150.698	76.200	17.5	17.74 kg	561251	317.500	53.975	4.8	9.11 kg	77.787	561256YD : HOLES IN OD CENTER
	5.9330	3.0000	.69	39.11 lb		12.5000	2.1250	.19	20.09 lb	3.0625	
EE560600	152.400	76.200	17.5	17.49 kg	*561256YD	319.075	187.452	1.5	36.22 kg	235.076	
	6.0000	3.0000	.69	38.56 lb		12.5620	7.3800	.06	79.86 lb	9.2550	
EE560629	159.918	76.200	10.5	16.79 kg	561279	323.850	53.975	4.8	10.62 kg	77.787	
	6.2960	3.0000	.41	37.02 lb		12.7500	2.1250	.19	23.42 lb	3.0625	
EE560631X	160.338	76.200	11.2	16.69 kg							
	6.3125	3.0000	.44	36.80 lb							
EE560650	165.100	76.200	3.3	16.20 kg							
	6.5000	3.0000	.13	35.72 lb							
560950	165.100	76.200	3.3	15.66 kg							
	6.5000	3.0000	.13	34.54 lb							
560990	149.860	76.200	3.3	17.91 kg							
	5.9000	3.0000	.13	39.49 lb							

†These Maximum Fillet Radii will be cleared by the Cone or Cup Radii.  
 †Bore or O.D. shown are maximum dimensions. \*See Remarks Column.

LL562700 – LL582900 SERIES

CONE			Max Shaft Fillet Radii R <sup>**</sup>	Weight	CUP			Max H's'ng Fillet Radii r <sup>**</sup>	Weight	BEARING WIDTH T	Remarks
Number	BORE d	WIDTH B			Number	OUTSIDE DIA D	WIDTH C				
<b>LL562700 Series</b>											
LL562749	361.950 14.2500	23.812 .9375	2.3 .09	2.65 kg 5.84 lb	LL562710	406.400 16.0000	17.462 .6875	1.5 .06	1.04 kg 2.28 lb	23.813 .9375	
<b>LM565900 Series</b>											
LM565943	374.650 14.7500	84.138 3.3125	6.4 .25	36.89 kg 81.34 lb	*LM565910-B	522.287 20.5625	61.912 2.4375	3.3 .13	15.70 kg 34.62 lb	38.100 1.5000	LM565910-B : FLANGE ON OD FRONTFACE, BEARING WIDTH IS T1 DIMENSION
LM565946	377.825 14.8750	84.138 3.3125	6.4 .25	35.65 kg 78.61 lb	LM565910	522.287 20.5625	61.912 2.4375	3.3 .13	14.74 kg 32.51 lb	85.724 3.3750	
LM565949	381.000 15.0000	84.138 3.3125	6.4 .25	34.45 kg 75.97 lb	LM565912	523.875 20.6250	61.912 2.4375	3.3 .13	15.37 kg 33.90 lb	85.724 3.3750	
<b>LL566800 Series</b>											
LL566848	403.225 15.8750	28.575 1.1250	3.5 .14	4.48 kg 9.88 lb	*LL566810-B	460.375 18.1250	22.225 .8750	3.3 .13	2.65 kg 5.85 lb	12.700 .5000	LL566810-B : FLANGE ON OD FRONTFACE, BEARING WIDTH IS T1 DIMENSION
					LL566810	460.375 18.1250	20.638 .8125	3.3 .13	2.05 kg 4.52 lb	28.575 1.1250	
<b>LM567900 Series</b>											
LM567943	396.875 15.6250	84.138 3.3125	6.4 .25	41.34 kg 91.16 lb	*LM567910-B	549.275 21.6250	61.912 2.4375	3.3 .13	17.41 kg 38.38 lb	38.100 1.5000	LM567910-B : FLANGE ON OD FRONTFACE, BEARING WIDTH IS T1 DIMENSION
LM567949	406.400 16.0000	84.138 3.3125	6.4 .25	37.70 kg 83.14 lb	LM567910	549.275 21.6250	61.912 2.4375	3.3 .13	15.96 kg 35.20 lb	85.725 3.3750	
<b>570000 Series</b>											
EE571602	406.400 16.0000	87.833 3.4580	6.4 .25	- -	572650	673.100 26.5000	60.325 2.3750	3.3 .13	11.94 kg 26.33 lb	88.900 3.5000	571700D: NO SMALL RIB
EE571703	431.800 17.0000	87.833 3.4580	6.4 .25	- -	*572651D	673.100 26.5000	127.000 5.0000	1.5 .06	60.32 kg 133.00 lb	192.639 7.5842	572651D : GROOVE IN OD CENTER HOLES IN OD CENTER
					*572653D	673.100 26.5000	152.400 6.0000	1.5 .06	70.60 kg 155.67 lb	192.639 7.5842	572653D : GROOVE IN OD CENTER HOLES IN OD CENTER
*571700D	430.212 16.9375	133.350 5.2500	1.6 .06	- -	572650	673.100 26.5000	60.325 2.3750	3.3 .13	11.94 kg 26.33 lb	157.673 6.2076	
<b>L570600 Series</b>											
L570648	457.073 17.9950	74.612 2.9375	6.4 .25	29.18 kg 64.34 lb	L570610	573.088 22.5625	57.150 2.2500	6.4 .25	12.55 kg 27.66 lb	74.613 2.9375	
L570649	457.200 18.0000	74.612 2.9375	6.4 .25	29.11 kg 64.19 lb							
<b>LL573700 Series</b>											
LL573748	508.000 20.0000	44.450 1.7500	3.5 .14	27.41 kg 60.45 lb	*LL573710DC	596.900 23.5000	73.025 2.8750	1.5 .06	13.49 kg 29.74 lb	95.250 3.7500	LL573710D : GROOVE IN OD CENTER HOLES IN OD CENTER
					*LL573710D	596.900 23.5000	73.025 2.8750	1.5 .06	13.49 kg 29.74 lb	95.250 3.7500	LL573710DC : HOLES IN OD CENTER
<b>LL575300 Series</b>											
LL575343	533.400 21.0000	50.800 2.0000	6.4 .25	21.36 kg 47.09 lb	LL575310	635.000 25.0000	38.100 1.5000	6.4 .25	6.91 kg 15.24 lb	50.800 2.0000	
LL575349	539.750 21.2500	50.800 2.0000	6.4 .25	19.22 kg 42.38 lb							
<b>LL579700 Series</b>											
LL579749	609.600 24.0000	60.325 2.3750	6.4 .25	56.68 kg 124.97 lb	*LL579710D	717.550 28.2500	95.250 3.7500	1.5 .06	24.76 kg 54.59 lb	127.003 5.0001	LL579710D : GROOVE IN OD CENTER HOLES IN OD CENTER
<b>580000 Series</b>											
EE580537	136.525 5.3750	79.375 3.1250	12.7 .50	16.74 kg 36.90 lb	581163XD	295.275 11.6250	146.050 5.7500	1.5 .06	21.55 kg 47.51 lb	193.675 7.6250	
580995	152.400 6.0000	79.375 3.1250	3.3 .13	14.37 kg 31.69 lb	581200	304.800 12.0000	55.562 2.1875	3.3 .13	9.40 kg 20.74 lb	79.375 3.1250	
<b>L580000 Series</b>											
L580049	609.600 24.0000	79.375 3.1250	6.4 .25	- -	L580010	774.700 30.5000	60.325 2.3750	6.4 .25	22.74 kg 50.14 lb	85.725 3.3750	
<b>LL580000 Series</b>											
LL580049	615.950 24.2500	41.275 1.6250	3.5 .14	16.28 kg 35.89 lb	LL580010	708.025 27.8750	29.367 1.1562	3.3 .13	6.95 kg 15.32 lb	41.275 1.6250	
<b>LL582900 Series</b>											
LL582949	736.600 29.0000	31.750 1.2500	3.5 .14	14.09 kg 31.06 lb	*LL582910-B	825.500 32.5000	25.400 1.0000	3.3 .13	7.22 kg 15.93 lb	12.700 .5000	LL582910-B : FLANGE ON OD FRONTFACE, BEARING WIDTH IS T1 DIMENSION
					LL582910	825.500 32.5000	25.400 1.0000	3.3 .13	6.61 kg 14.56 lb	31.750 1.2500	

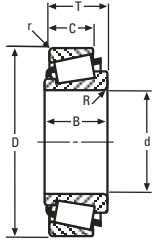

SINGLE ROW



SINGLE ROW WITH FLANGE

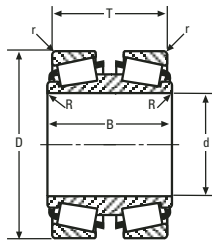

DOUBLE CONE

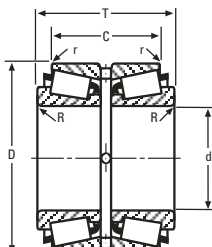

DOUBLE CUP

LL584400 SERIES CONTINUED ON NEXT PAGE

\*\*These Maximum Fillet Radii will be cleared by the Cone or Cup Radii.  
†Bore or O.D. shown are maximum dimensions. \*See Remarks Column.

LL584400 – L610500 SERIES

CONE			Max Shaft Fillet Radii R''	Weight	CUP			Max Hs'ng Fillet Radii r''	Weight	BEARING	Remarks
Number	BORE d	WIDTH B			Number	OUTSIDE DIA D	WIDTH C			WIDTH T	
<b>LL584400 Series</b>											
LL584449	801.688 31.5625	58.738 2.3125	3.5 .14	38.24 kg 84.32 lb	LL584410	914.400 36.0000	41.275 1.6250	3.3 .13	14.44 kg 31.84 lb	58.738 2.3125	
<b>LL586000 Series</b>											
LL586049	863.600 34.0000	44.450 1.7500	3.5 .14	24.02 kg 52.96 lb	*LL586018-B	977.900 38.5000	33.338 1.3125	3.3 .13	19.27 kg 42.48 lb	19.050 .7500	LL586018-B : FLANGE ON OD FRONTFACE, BEARING WIDTH IS T1 DIMENSION
<b>590000 Series</b>											
EE590638	161.925 6.3750	80.962 3.1875	6.4 .25	21.14 kg 46.60 lb	591326	336.550 13.2500	53.975 2.1250	6.4 .25	10.31 kg 22.73 lb	79.375 3.1250	
EE590649	165.100 6.5000	80.962 3.1875	1.3 .05	20.62 kg 45.46 lb	591350	342.900 13.5000	53.975 2.1250	6.4 .25	11.14 kg 24.56 lb	79.375 3.1250	
EE590650	165.100 6.5000	80.962 3.1875	17.5 .69	20.62 kg 45.46 lb							
EE590675	171.450 6.7500	80.962 3.1875	6.4 .25	19.63 kg 43.29 lb							
590900	177.800 7.0000	80.962 3.1875	3.3 .13	18.93 kg 41.73 lb							
590938	161.925 6.3750	80.962 3.1875	6.4 .25	21.55 kg 47.52 lb							
590977	171.450 6.7500	84.138 3.3125	1.3 .05	20.37 kg 44.92 lb							
<b>LM603000 Series</b>											
*LM603045DA	42.862 1.6875	78.524 3.0915	.8 .03	.94 kg 2.07 lb	LM603011	77.788 3.0625	15.080 .5937	.8 .03	.12 kg .27 lb	39.687 1.5625	LM603045DA: ASYMMETRICAL BEARING HOLES IN OD LEFTFACE
*LM603046DA	44.450 1.7500	78.524 3.0915	.8 .03	.87 kg 1.92 lb	LM603012	77.788 3.0625	16.667 .6562	.8 .03	.14 kg .31 lb	42.862 1.6875	LM603046DA: ASYMMETRICAL BEARING HOLES IN OD LEFTFACE
					†JLM603013-Z	78.000 3.0709	15.000 .5906	2.3 .09	.12 kg .28 lb	39.682 1.5623	LM603047DE: EXTENDED SMALL RIB
					LM603014	79.974 3.1486	15.080 .5937	.8 .03	.15 kg .34 lb	39.687 1.5625	
					LM603015	79.974 3.1486	16.667 .6562	.8 .03	.17 kg .38 lb	42.862 1.6875	
					LM603019	77.788 3.0625	16.667 .6562	.8 .03	.14 kg .31 lb	42.862 1.6875	
LM603049	45.242 1.7812	19.842 .7812	3.5 .14	.25 kg .54 lb	LM603011	77.788 3.0625	15.080 .5937	.8 .03	.12 kg .27 lb	19.842 .7812	
LM603049AS	45.242 1.7812	19.842 .7812	.8 .03	.25 kg .55 lb	LM603012	77.788 3.0625	16.667 .6562	.8 .03	.14 kg .31 lb	21.430 .8437	
					†JLM603013-Z	78.000 3.0709	15.000 .5906	2.3 .09	.12 kg .28 lb	19.842 .7812	
					LM603014	79.974 3.1486	15.080 .5937	.8 .03	.15 kg .34 lb	19.842 .7812	
					LM603015	79.974 3.1486	16.667 .6562	.8 .03	.17 kg .38 lb	21.430 .8437	
					LM603019	77.788 3.0625	16.667 .6562	.8 .03	.14 kg .31 lb	21.430 .8437	
*LM603047DE	44.552 1.7540	89.002 3.5040	1.0 .04	.93 kg 2.06 lb	LM603047DE may be paired with all single cups corresponding to LM603045DA and will require 6.312 mm (.2485 in) to be added to the T-width values.						
†JLM603048F	45.000 1.7717	24.000 .9449	3.5 .14	.26 kg .56 lb	JLM603048F may be paired with all single cups corresponding to LM603045DA and will require 1.661 mm (.0654 in) to be added to the T-width values.						
<b>607000 Series</b>											
EE607070	177.800 7.0000	77.788 3.0625	6.4 .25	-	607140	355.600 14.0000	53.975 2.1250	6.4 .25	10.61 kg 23.40 lb	79.375 3.1250	EE607071: HOLES IN BACKFACE
*EE607071	177.292 6.9800	77.788 3.0625	6.4 .25	-							
EE607075	190.500 7.5000	77.788 3.0625	6.4 .25	-							
<b>L610500 Series</b>											
L610549	63.500 2.5000	19.050 .7500	1.5 .06	.30 kg .67 lb	L610510	94.458 3.7188	15.083 .5938	1.5 .06	.15 kg .34 lb	19.050 .7500	L610510D : GROOVE IN OD CENTER HOLES IN OD CENTER
					*L610510D	94.458 3.7188	34.925 1.3750	.8 .03	.36 kg .80 lb	42.860 1.6874	

8

\*\*These Maximum Fillet Radii will be cleared by the Cone or Cup Radii.  
†Bore or O.D. shown are maximum dimensions. \*See Remarks Column.

M612900 – M624600 SERIES

CONE			Max Shaft Fillet Radii R <sup>**</sup>	Weight	CUP			Max H's'ng Fillet Radii r <sup>**</sup>	Weight	BEARING WIDTH T	Remarks
Number	BORE d	WIDTH B			Number	OUTSIDE DIA D	WIDTH C				
<b>M612900 Series</b>											
*†JM612949	70.000 2.7559	29.000 1.1417	3.0 .12	.77 kg 1.70 lb	†JM612910	115.000 4.5276	23.000 .9055	2.5 .10	.36 kg .79 lb	29.000 1.1417	JM612949: FRONTFACE CHAMFER
					*†JM612910V	115.000 4.5276	23.000 .9055	2.5 .10	.36 kg .79 lb	29.000 1.1417	JM612910V : MADE FROM VACUUM MELT STEEL
<b>LM613400 Series</b>											
LM613449	69.850 2.7500	21.996 .8660	1.5 .06	.54 kg 1.20 lb	LM613410	112.712 4.4375	15.875 .6250	.8 .03	.24 kg .53 lb	22.225 .8750	LM613449XX: MADE FROM VACUUM MELT STEEL
*LM613449XX	69.850 2.7500	21.996 .8660	1.5 .06	.54 kg 1.20 lb	*LM613410-B	112.712 4.4375	15.875 .6250	.8 .03	.29 kg .63 lb	11.112 .4375	LM613410-B : FLANGE ON OD FRONTFACE, BEARING WIDTH IS T1 DIMENSION
					*LM613410XX	112.712 4.4375	15.875 .6250	.8 .03	.24 kg .53 lb	22.225 .8750	LM613410XX : MADE FROM VACUUM MELT STEEL
<b>HM617000 Series</b>											
HM617045	82.550 3.2500	42.862 1.6875	3.5 .14	1.96 kg 4.32 lb	HM617010	142.138 5.5960	34.133 1.3438	3.3 .13	.90 kg 1.98 lb	42.863 1.6875	HM617010DC : GROOVE IN OD CENTER HOLES IN OD CENTER
HM617048	85.725 3.3750	42.862 1.6875	1.5 .06	1.83 kg 4.03 lb	*HM617011DC	142.875 5.6250	76.200 3.0000	.8 .03	2.27 kg 5.01 lb	93.660 3.6874	
HM617049	85.725 3.3750	42.862 1.6875	4.8 .19	1.81 kg 3.98 lb							
<b>618000 Series</b>											
EE618065	165.100 6.5000	68.262 2.6875	9.7 .38	- -	*618136D	347.662 13.6875	107.950 4.2500	1.5 .06	20.77 kg 45.79 lb	146.049 5.7500	618136D : GROOVE IN OD CENTER HOLES IN OD CENTER
<b>620000 Series</b>											
EE620100	254.000 10.0000	104.775 4.1250	8.0 .31	- -	620220	558.800 22.0000	69.850 2.7500	8.0 .31	41.89 kg 92.36 lb	123.825 4.8750	
<b>L623100 Series</b>											
L623149	114.300 4.5000	21.433 .8438	1.5 .06	.71 kg 1.57 lb	*L623110-B	152.400 6.0000	16.670 .6563	1.5 .06	.35 kg .77 lb	8.732 .3438	L623110-B : FLANGE ON OD FRONTFACE, BEARING WIDTH IS T1 DIMENSION
					L623110	152.400 6.0000	16.670 .6563	1.5 .06	.34 kg .75 lb	21.432 .8438	L623110D : GROOVE IN OD CENTER HOLES IN OD CENTER
					*L623110DC	152.400 6.0000	38.100 1.5000	.8 .03	.68 kg 1.51 lb	47.625 1.8750	L623110DC : HOLES IN OD CENTER
					*L623110D	152.400 6.0000	38.100 1.5000	.8 .03	.68 kg 1.51 lb	47.625 1.8750	
					L623114	155.575 6.1250	21.433 .8438	1.5 .06	.52 kg 1.14 lb	21.432 .8438	
<b>L624500 Series</b>											
†JL624548	120.000 4.7244	21.433 .8438	1.5 .06	.80 kg 1.76 lb	*L624510-B	160.338 6.3125	16.670 .6563	1.5 .06	.42 kg .94 lb	8.733 .3438	L624549D: ASYMMETRICAL BEARING
L624549	120.650 4.7500	21.433 .8438	1.5 .06	.77 kg 1.70 lb	L624510	160.338 6.3125	16.670 .6563	1.5 .06	.39 kg .86 lb	21.433 .8438	L624510-B : FLANGE ON OD FRONTFACE, BEARING WIDTH IS T1 DIMENSION
					L624511	158.750 6.2500	16.670 .6563	1.5 .06	.34 kg .74 lb	21.433 .8438	L624514D : GROOVE IN OD CENTER HOLES IN OD CENTER
					L624514	161.925 6.3750	16.670 .6563	1.5 .06	.44 kg .97 lb	21.433 .8438	
					*L624514D	161.925 6.3750	53.975 2.1250	.8 .03	1.40 kg 3.08 lb	63.500 2.5000	
					†JL624516	165.000 6.4961	16.670 .6563	1.5 .06	.55 kg 1.21 lb	21.433 .8438	
*L624549D	120.650 4.7500	50.008 1.9688	1.5 .06	2.06 kg 4.55 lb	L624510	160.338 6.3125	16.670 .6563	1.5 .06	.39 kg .86 lb	42.865 1.6876	
					L624511	158.750 6.2500	16.670 .6563	1.5 .06	.34 kg .74 lb	42.865 1.6876	
					L624514	161.925 6.3750	16.670 .6563	1.5 .06	.44 kg .97 lb	42.865 1.6876	
					†JL624516	165.000 6.4961	16.670 .6563	1.5 .06	.55 kg 1.21 lb	42.865 1.6876	
<b>M624600 Series</b>											
†JM624649	120.000 4.7244	36.000 1.4173	3.5 .14	2.20 kg 4.85 lb	*M624610-B	179.974 7.0856	26.000 1.0236	1.5 .06	1.00 kg 2.20 lb	16.350 .6437	M624610-B : FLANGE ON OD FRONTFACE, BEARING WIDTH IS T1 DIMENSION
M624649	119.974 4.7234	36.000 1.4173	3.5 .14	2.20 kg 4.85 lb	*†JM624610-B	180.000 7.0866	26.000 1.0236	1.5 .06	1.00 kg 2.20 lb	16.578 .6527	M624610-B : FLANGE ON OD FRONTFACE, BEARING WIDTH IS T1 DIMENSION

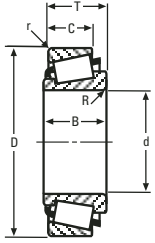

SINGLE ROW



SINGLE ROW WITH FLANGE

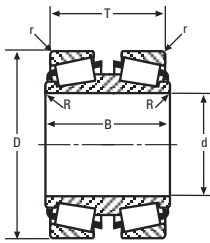

DOUBLE CONE

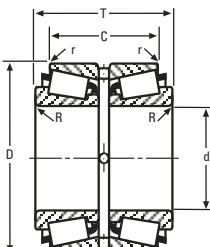

DOUBLE CUP

M624600 SERIES CONTINUED ON NEXT PAGE

\*\*These Maximum Fillet Radii will be cleared by the Cone or Cup Radii.  
†Bore or O.D. shown are maximum dimensions. \*See Remarks Column.

CONE			Max Shaft Fillet Radii R''	Weight	CUP			Max Hs'ng Fillet Radii r''	Weight	BEAR-ING	Remarks
Number	BORE d	WIDTH B			Number	OUTSIDE DIA D	WIDTH C			WIDTH T	
M624600 Series (cont)					M624610	179.974 7.0856	26.000 1.0236	1.5 .06	.89 kg 1.96 lb	36.000 1.4173	
					†JM624610	180.000 7.0866	26.000 1.0236	1.5 .06	.88 kg 1.95 lb	36.000 1.4173	
HM624700 Series											
HM624749	120.650 4.7500	46.038 1.8125	3.5 .14	3.22 kg 7.11 lb	*HM624710-B	190.500 7.5000	34.925 1.3750	1.5 .06	1.65 kg 3.65 lb	19.050 .7500	HM624710-B : FLANGE ON OD FRONTFACE, BEARING WIDTH IS T1 DIMENSION
					HM624710	190.500 7.5000	34.925 1.3750	1.5 .06	1.45 kg 3.20 lb	46.037 1.8125	HM624716-B : FLANGE ON OD FRONTFACE, BEARING WIDTH IS T1 DIMENSION
					*HM624716-B	199.974 7.8730	34.925 1.3750	1.5 .06	2.49 kg 5.48 lb	19.050 .7500	
					HM624716	199.974 7.8730	34.925 1.3750	1.5 .06	2.24 kg 4.94 lb	46.037 1.8125	
626000 Series											
EE626210	533.400 21.0000	123.825 4.8750	9.7 .38	-	*626321D	812.800 32.0000	187.325 7.3750	3.3 .13	140.49 kg 309.79 lb	269.875 10.6250	626321D : GROOVE IN OD CENTER HOLES IN OD CENTER
627000 Series											
*EE627260D	660.400 26.0000	571.500 22.5000	12.7 .50	-	*627435	1104.900 43.5000	190.500 7.5000	3.3 .13	321.97 kg 709.95 lb	444.500 17.5000	EE627260D: GROOVE IN ID CENTER INVERTED BEARING  627435 : SHOULDER ON OD BACKFACE SPECIAL RADIUS ON BACKFACE OD
628000 Series											
*EE628285D	723.900 28.5000	571.500 22.5000	12.7 .50	-	*628465	1181.100 46.5000	190.500 7.5000	3.3 .13	340.96 kg 751.81 lb	444.500 17.5000	EE628285D: GROOVE IN ID CENTER INVERTED BEARING  628465 : SHOULDER ON OD BACKFACE SPECIAL RADIUS ON BACKFACE OD
L630300 Series											
L630349	152.400 6.0000	24.000 .9449	2.0 .08	1.10 kg 2.44 lb	L630310	192.088 7.5625	19.000 .7480	2.0 .08	.46 kg 1.02 lb	25.000 .9843	L630310-B : FLANGE ON OD FRONTFACE, BEARING WIDTH IS T1 DIMENSION
L630349A	152.400 6.0000	24.000 .9449	2.0 .08	.91 kg 2.00 lb	*L630310-B	192.088 7.5625	19.000 .7480	2.0 .08	.53 kg 1.18 lb	9.970 .3925	
L630349RR	152.400 6.0000	24.000 .9449	2.0 .08	1.12 kg 2.47 lb	L630310RR	192.088 7.5625	19.000 .7480	2.0 .08	.50 kg 1.11 lb	25.000 .9843	
631000 Series											
EE631305D	774.700 30.5000	406.674 16.0108	6.4 .25	-	631480	1219.200 48.0000	165.100 6.5000	12.7 .50	280.24 kg 617.94 lb	406.400 16.0000	EE631307DG: GROOVE IN ID
EE631307D	779.925 30.7057	406.674 16.0108	6.4 .25	-	631482	1219.873 48.0265	167.742 6.6040	12.7 .50	288.01 kg 635.06 lb	411.683 16.2080	
*EE631307DG	779.925 30.7057	406.674 16.0108	6.4 .25	-	631484	1219.873 48.0265	165.237 6.5054	12.7 .50	282.22 kg 622.30 lb	406.675 16.0108	
EE631310D	779.925 30.7057	406.400 16.0000	6.4 .25	-							
EE631311D	787.400 31.0000	406.400 16.0000	6.4 .25	-							
634000 Series											
*EE634356D	901.700 35.5000	438.150 17.2500	4.8 .19	-	634510	1295.400 51.0000	193.675 7.6250	12.7 .50	305.40 kg 673.41 lb	450.850 17.7500	EE634356D: HOLES IN OD CENTER
XR637000 Series											
SEE CROSSED ROLLER BEARING SECTION											
LL639200 Series											
LL639249	196.850 7.7500	23.017 .9062	1.5 .06	1.54 kg 3.39 lb	LL639210	241.300 9.5000	17.462 .6875	1.5 .06	.57 kg 1.26 lb	23.813 .9375	LL639249XX: MADE FROM VACUUM MELT STEEL
*LL639249XX	196.850 7.7500	23.017 .9062	1.5 .06	1.54 kg 3.39 lb	*LL639210XX	241.300 9.5000	17.462 .6875	1.5 .06	.57 kg 1.26 lb	23.813 .9375	LL639210XX: MADE FROM VACUUM MELT STEEL
640000 Series											
EE640191	488.671 19.2390	94.458 3.7188	6.4 .25	-	*640260-B	660.400 26.0000	69.850 2.7500	6.4 .25	26.94 kg 59.41 lb	38.100 1.5000	EE640193D: SHOULDER ON OD RIGHTFACE
EE640192	488.950 19.2500	94.458 3.7188	6.4 .25	-	640260	660.400 26.0000	69.850 2.7500	6.4 .25	23.95 kg 52.82 lb	93.662 3.6875	640260-B : FLANGE ON OD FRONTFACE, BEARING WIDTH IS T1 DIMENSION
					640261XD	660.400 26.0000	158.750 6.2500	1.6 .06	-	206.375 8.1250	640261CD : GROOVE IN OD CENTER HOLES IN OD CENTER

\*\*These Maximum Fillet Radii will be cleared by the Cone or Cup Radii.  
†Bore or O.D. shown are maximum dimensions. \*See Remarks Column.

640000 – M652900 SERIES

CONE			Max Shaft Fillet Radii R <sup>**</sup>	Weight	CUP			Max Hs'ng Fillet Radii r <sup>**</sup>	Weight	BEARING WIDTH T	Remarks
Number	BORE d	WIDTH B			Number	OUTSIDE DIA D	WIDTH C				
<b>640000 Series (cont)</b>											
					*640261CD	660.400 26.0000	158.750 6.2500	1.5 .06	54.17 kg 119.44 lb	206.375 8.1250	640262D : GROOVE IN OD CENTER HOLES IN OD CENTER
					*640262D	666.674 26.2470	158.750 6.2500	1.5 .06	67.51 kg 148.86 lb	206.375 8.1250	
*EE640193D	488.950 19.2500	174.625 6.8750	3.3 .13	-	640260	660.400 26.0000	69.850 2.7500	6.4 .25	23.95 kg 52.82 lb	171.450 6.7500	
<b>641000 Series</b>											
*EE641198D	501.650 19.7500	190.500 7.5000	3.3 .13	-	641265	673.100 26.5000	76.200 3.0000	6.4 .25	27.11 kg 59.77 lb	184.150 7.2500	EE641198D : ASYMMETRICAL BEARING HOLES IN OD CENTER
*EE641198DWA	501.650 19.7500	190.500 7.5000	3.3 .13	-							EE641198DWA : ASYMMETRICAL BEARING HOLES IN OD CENTER
<b>LL641100 Series</b>											
*LL641148	203.479 8.0110	31.750 1.2500	1.5 .06	2.68 kg 5.91 lb	LL641110	261.142 10.2812	21.433 .8438	1.5 .06	1.05 kg 2.32 lb	28.575 1.1250	LL641148 : EXTENDED SMALL RIB
LL641149	203.200 8.0000	27.783 1.0938	1.5 .06	2.47 kg 5.44 lb	LL641111	261.142 10.2812	21.433 .8438	1.5 .06	1.07 kg 2.37 lb	28.575 1.1250	
LL641149A	206.375 8.1250	27.783 1.0938	1.5 .06	2.26 kg 4.99 lb							
<b>647000 Series</b>											
EE647220	558.800 22.0000	73.025 2.8750	4.8 .19	-	647285	723.900 28.5000	57.150 2.2500	4.8 .19	20.37 kg 44.90 lb	73.025 2.8750	
<b>HM647400 Series</b>											
HM647448	231.775 9.1250	80.962 3.1875	3.3 .13	23.08 kg 50.89 lb	HM647411	377.825 14.8750	58.738 2.3125	3.3 .13	10.49 kg 23.14 lb	79.375 3.1250	
<b>LL648400 Series</b>											
LL648434	243.682 9.5938	31.750 1.2500	3.5 .14	4.25 kg 9.38 lb	*LL648415-B	315.912 12.4375	22.225 .8750	3.3 .13	1.87 kg 4.13 lb	14.527 .5719	LL648448W : KEYWAY IN BACKFACE  LL648415-B : FLANGE ON OD FRONTFACE, BEARING WIDTH IS T1 DIMENSION
*LL648448W	254.000 10.0000	31.750 1.2500	6.4 .25	3.16 kg 6.97 lb	LL648415	315.912 12.4375	22.225 .8750	3.3 .13	1.68 kg 3.71 lb	31.750 1.2500	
LL648449	254.000 10.0000	31.750 1.2500	3.5 .14	3.25 kg 7.17 lb	LL648416	315.912 12.4375	22.225 .8750	4.8 .19	1.64 kg 3.61 lb	31.750 1.2500	
<b>649000 Series</b>											
EE649236X	602.945 23.7380	93.662 3.6875	6.4 .25	82.46 kg 181.83 lb	649310	787.400 31.0000	69.850 2.7500	6.4 .25	32.00 kg 70.56 lb	93.663 3.6875	649311CD : GROOVE IN OD CENTER HOLES IN OD CENTER
EE649237	602.945 23.7380	93.662 3.6875	6.4 .25	-	*649311CD	787.400 31.0000	158.750 6.2500	1.5 .06	73.00 kg 160.97 lb	206.375 8.1250	649313D : GROOVE IN OD CENTER HOLES IN OD CENTER
EE649238	609.346 23.9900	93.662 3.6875	6.4 .25	-	*649313D	793.750 31.2500	158.750 6.2500	1.5 .06	84.62 kg 186.59 lb	206.375 8.1250	
EE649239	607.720 23.9260	93.662 3.6875	6.4 .25	-							
EE649240	609.600 24.0000	93.662 3.6875	6.4 .25	-							
EE649241D	609.600 24.0000	171.450 6.7500	3.3 .13	-	649310	787.400 31.0000	69.850 2.7500	6.4 .25	32.00 kg 70.56 lb	171.450 6.7500	
EE649241DW	609.600 24.0000	171.450 6.7500	3.3 .13	-							
EE649242DW	609.600 24.0000	171.450 6.7500	6.4 .25	-							
<b>650000 Series</b>											
EE650170	431.902 17.0040	174.625 6.8750	6.4 .25	-	650270	685.698 26.9960	142.875 5.6250	6.4 .25	77.47 kg 170.82 lb	177.800 7.0000	650270D : GROOVE IN OD CENTER HOLES IN OD CENTER
					*650270D	685.698 26.9960	295.275 11.6250	3.3 .13	162.47 kg 358.24 lb	365.125 14.3750	
EE650171D	431.902 17.0040	330.200 13.0000	spcl. spcl.	-	650270	685.698 26.9960	142.875 5.6250	6.4 .25	77.47 kg 170.82 lb	330.200 13.0000	
<b>XR652000 Series</b>											
SEE CROSSED ROLLER BEARING SECTION											
<b>M652900 Series</b>											
M652949DW	279.400 11.0000	127.000 5.0000	1.5 .06	39.53 kg 87.16 lb	M652911	393.700 15.5000	50.800 2.0000	6.4 .25	5.92 kg 13.04 lb	127.000 5.0000	

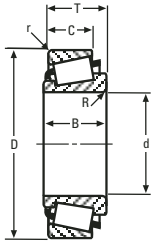

SINGLE ROW

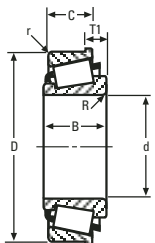

SINGLE ROW WITH FLANGE

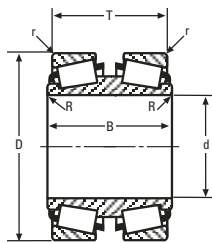

DOUBLE CONE

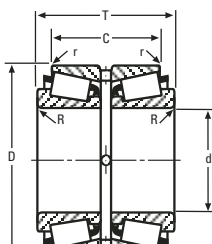

DOUBLE CUP

LM654600 – LM665900 SERIES

CONE			Max Shaft Fillet Radii R <sup>**</sup>	Weight	CUP			Max Hs'ng Fillet Radii r <sup>**</sup>	Weight	BEAR-ING	Remarks
Number	BORE d	WIDTH B			Number	OUTSIDE DIA D	WIDTH C			WIDTH T	
<b>LM654600 Series</b>											
LM654640D	273.050 10.7500	117.475 4.6250	1.5 .06	36.10 kg 79.60 lb	LM654610	380.898 14.9960	49.212 1.9375	3.3 .13	6.49 kg 14.32 lb	117.475 4.6250	LM654610-B : FLANGE ON OD FRONTFACE, BEARING WIDTH IS T1 DIMENSION
LM654644D	279.578 11.0070	117.475 4.6250	1.5 .06	34.08 kg 75.14 lb	LM654611	380.009 14.9610	49.212 1.9375	3.3 .13	6.29 kg 13.86 lb	117.475 4.6250	LM654610CD : GROOVE IN OD CENTER HOLES IN OD CENTER
LM654644DW	279.578 11.0070	117.475 4.6250	1.5 .06	33.29 kg 73.41 lb							
LM654648D	285.750 11.2500	117.475 4.6250	1.5 .06	30.97 kg 68.28 lb							
LM654648DW	285.750 11.2500	117.475 4.6250	1.5 .06	30.92 kg 68.17 lb							
LM654642'	279.982 11.0229	65.088 2.5625	3.5 .14	14.72 kg 32.45 lb	*LM654610-B	380.898 14.9960	49.212 1.9375	3.3 .13	6.98 kg 15.40 lb	25.400 1.0000	
LM654649	285.750 11.2500	65.088 2.5625	3.5 .14	13.41 kg 29.57 lb	LM654610	380.898 14.9960	49.212 1.9375	3.3 .13	6.49 kg 14.32 lb	65.088 2.5625	
LM654649AA	285.750 11.2500	65.088 2.5625	12.7 .50	12.90 kg 28.44 lb	*LM654610CD	380.898 14.9960	107.950 4.2500	1.5 .06	14.03 kg 30.93 lb	139.700 5.5000	
					LM654611	380.009 14.9610	49.212 1.9375	3.3 .13	6.29 kg 13.86 lb	65.088 2.5625	
<b>655000 Series</b>											
EE655270	685.800 27.0000	92.075 3.6250	6.4 .25	- -	655345	876.300 34.5000	69.850 2.7500	6.4 .25	39.20 kg 86.43 lb	93.662 3.6875	EE655271DGW: GROOVE IN ID
*EE655272T	695.325 27.3750	92.075 3.6250	6.4 .25	- -	*655346DC	876.300 34.5000	152.400 6.0000	1.5 .06	90.19 kg 198.87 lb	200.024 7.8750	EE655271DWA: ASYMMETRICAL BEARING EXTENDED SMALL RIB SLOTS IN RIGHTFACE
					*655346D	876.300 34.5000	152.400 6.0000	1.5 .06	84.85 kg 187.09 lb	200.024 7.8750	
					*655346CD	876.300 34.5000	152.400 6.0000	1.5 .06	86.17 kg 190.00 lb	200.024 7.8750	EE655272DWA: ASYMMETRICAL BEARING HOLES IN LEFTFACE SHOULDER ON OD RIGHTFACE SLOTS IN LEFTFACE
EE655271D	685.800 27.0000	168.275 6.6250	3.3 .13	- -	655345	876.300 34.5000	69.850 2.7500	6.4 .25	39.20 kg 86.43 lb	171.449 6.7500	EE655272T: REVERSE TAPERED BORE
*EE655271DGW	685.800 27.0000	168.275 6.6250	3.3 .13	- -							655346CD : GROOVE IN OD CENTER HOLES IN OD CENTER
EE655271DW	685.800 27.0000	168.275 6.6250	3.3 .13	- -							655346D : GROOVE IN OD CENTER HOLES IN OD CENTER
*EE655271DWA	685.800 27.0000	209.550 8.2500	3.3 .13	- -							
*EE655272DWA	685.800 27.0000	220.662 8.6875	3.3 .13	- -							655346DC : HOLES IN OD CENTER
<b>660000 Series</b>											
*662300D	584.200 23.0000	215.900 8.5000	3.3 .13	- -	663550	901.700 35.5000	107.950 4.2500	9.7 .38	87.41 kg 192.75 lb	270.668 10.6562	662300D: NO SMALL RIB
EE662303	584.200 23.0000	139.700 5.5000	8.0 .31	- -	663550	901.700 35.5000	107.950 4.2500	9.7 .38	87.41 kg 192.75 lb	150.021 5.9063	663551D : GROOVE IN OD CENTER HOLES IN OD CENTER
EE662303V	584.200 23.0000	139.700 5.5000	8.0 .31	- -	*663551DC	901.700 35.5000	214.312 8.4375	1.5 .06	176.42 kg 389.01 lb	298.455 11.7502	
					*663551D	901.700 35.5000	214.312 8.4375	1.5 .06	176.42 kg 389.01 lb	298.455 11.7502	
<b>LL660700 Series</b>											
LL660749A	338.138 13.3125	33.338 1.3125	3.3 .13	5.15 kg 11.35 lb	LL660711	403.225 15.8750	26.988 1.0625	3.3 .13	2.57 kg 5.66 lb	33.338 1.3125	
<b>665000 Series</b>											
*EE665231D	584.200 23.0000	254.000 10.0000	3.3 .13	- -	665355	901.700 35.5000	107.950 4.2500	9.7 .38	87.44 kg 192.80 lb	270.668 10.6562	EE665231D: SHOULDER ON ID LEFTSIDE
<b>LM665900 Series</b>											
LM665949	385.762 15.1875	82.550 3.2500	6.4 .25	30.97 kg 68.29 lb	LM665910	514.350 20.2500	63.500 2.5000	3.3 .13	14.22 kg 31.36 lb	82.550 3.2500	LM665949DGW: GROOVE IN ID
LM665949A	385.762 15.1875	82.550 3.2500	15.0 .59	30.07 kg 66.31 lb	*LM665910CD	514.350 20.2500	139.700 5.5000	1.5 .06	31.09 kg 68.56 lb	177.800 7.0000	LM665910CD : GROOVE IN OD CENTER HOLES IN OD CENTER

\*\*These Maximum Fillet Radii will be cleared by the Cone or Cup Radii.  
†Bore or O.D. shown are maximum dimensions. \*See Remarks Column.

LM665900 SERIES CONTINUED ON NEXT PAGE

LM665900 – L670800 SERIES

CONE			Max Shaft Fillet Radii R <sup>**</sup>	Weight	CUP			Max Hs'ng Fillet Radii r <sup>**</sup>	Weight	BEARING	Remarks
Number	BORE d	WIDTH B			Number	OUTSIDE DIA D	WIDTH C			WIDTH T	
<b>LM665900 Series (cont)</b>											
*LM665949D <sub>GW</sub>	385.762 15.1875	152.400 6.0000	3.3 .13	72.99 kg 160.93 lb	LM665910	514.350 20.2500	63.500 2.5000	3.3 .13	14.22 kg 31.36 lb	152.400 6.0000	
LM665949D <sub>W</sub>	385.762 15.1875	152.400 6.0000	3.3 .13	73.07 kg 161.13 lb							
<b>LM667700 Series</b>											
*LM667745D <sub>GW</sub>	406.400 16.0000	144.462 5.6875	1.5 .06	72.36 kg 159.54 lb	*LM667714W	546.100 21.5000	56.129 2.2098	5.0 .20	13.80 kg 30.44 lb	138.483 5.4521	LM667745D <sub>GW</sub> : ASYMMETRICAL BEARING EXTENDED SMALL RIB GROOVE IN ID SHOULDER ON ID LEFTSIDE
					*LM667714X	546.100 21.5000	60.109 2.3665	- -	14.52 kg 32.02 lb	146.444 5.7655	LM667714W : SLOTS IN BACKFACE LM667714X : SHOULDER ON OD BACKFACE
<b>M667900 Series</b>											
M667935	387.248 15.2460	87.312 3.4375	6.4 .25	- -	M667910	546.100 21.5000	66.675 2.6250	6.4 .25	16.55 kg 36.50 lb	87.312 3.4375	M667946D <sub>W</sub> : SHOULDER ON OD RIGHTFACE
M667944	406.400 16.0000	87.312 3.4375	6.4 .25	- -	*M667910D	546.100 21.5000	144.462 5.6875	1.5 .06	38.02 kg 83.83 lb	185.737 7.3125	M667947AD <sub>W</sub> : HOLES IN OD CENTER
M667947	409.575 16.1250	87.312 3.4375	6.4 .25	- -	M667910XD	546.100 21.5000	144.462 5.6875	1.5 .06	37.85 kg 83.46 lb	185.737 7.3125	M667947DA : HOLES IN OD CENTER
M667948	409.575 16.1250	87.312 3.4375	6.4 .25	36.70 kg 80.93 lb	M667911	546.100 21.5000	68.262 2.6875	6.4 .25	16.76 kg 36.95 lb	87.313 3.4375	M667947D <sub>GW</sub> : GROOVE IN ID
*M667948H	409.575 16.1250	87.312 3.4375	6.4 .25	- -	*M667911D	546.100 21.5000	147.638 5.8125	1.5 .06	38.45 kg 84.78 lb	185.738 7.3125	M667948H : GROOVE IN OD FRONTFACE NO SMALL RIB SHOULDER ON OD FRONTFACE
					*M667911DC	546.100 21.5000	147.638 5.8125	1.5 .06	40.09 kg 88.40 lb	185.738 7.3125	M667910D : GROOVE IN OD CENTER HOLES IN OD CENTER
					*M667911DXX	546.100 21.5000	147.638 5.8125	1.5 .06	38.45 kg 84.78 lb	185.738 7.3125	M667911D : GROOVE IN OD CENTER HOLES IN OD CENTER
					M667911XX	546.100 21.5000	68.262 2.6875	6.4 .25	16.76 kg 36.95 lb	87.313 3.4375	M667911D : GROOVE IN OD CENTER HOLES IN OD CENTER
M667944D <sub>W</sub>	406.400 16.0000	161.925 6.3750	1.5 .06	- -	M667910	546.100 21.5000	66.675 2.6250	6.4 .25	16.55 kg 36.50 lb	161.925 6.3750	M667911DC : HOLES IN OD CENTER
*M667946D <sub>W</sub>	409.575 16.1250	161.925 6.3750	5.0 .20	- -	M667911	546.100 21.5000	68.262 2.6875	6.4 .25	16.76 kg 36.95 lb	161.925 6.3750	M667911DXX : GROOVE IN OD CENTER HOLES IN OD CENTER
*M667947AD <sub>W</sub>	409.575 16.1250	161.925 6.3750	1.5 .06	84.51 kg 186.33 lb	M667911XX	546.100 21.5000	68.262 2.6875	6.4 .25	16.76 kg 36.95 lb	161.925 6.3750	
M667947D	409.575 16.1250	161.925 6.3750	1.5 .06	85.19 kg 187.85 lb							
*M667947DA	409.575 16.1250	161.925 6.3750	1.5 .06	85.19 kg 187.85 lb							
*M667947D <sub>GW</sub>	409.575 16.1250	161.925 6.3750	1.5 .06	84.78 kg 186.93 lb							
M667947D <sub>W</sub>	409.575 16.1250	161.925 6.3750	1.5 .06	84.85 kg 187.09 lb							
M667949D	409.575 16.1250	161.925 6.3750	1.5 .06	- -							
M667949D <sub>XX</sub>	409.575 16.1250	161.925 6.3750	1.5 .06	- -							
<b>LL669800 Series</b>											
LL669849	444.500 17.5000	34.925 1.3750	3.5 .14	14.80 kg 32.64 lb	LL669810XD	517.525 20.3750	53.975 2.1250	1.5 .06	8.31 kg 18.32 lb	73.025 2.8750	
<b>670000 Series</b>											
EE671798D	457.073 17.9950	196.850 7.7500	1.5 .06	- -	672873	730.148 28.7460	82.550 3.2500	6.4 .25	50.64 kg 111.65 lb	203.203 8.0001	671800 : NO SMALL RIB SHOULDER ON OD FRONTFACE
*671800	457.200 18.0000	114.300 4.5000	9.7 .38	- -	672873	730.148 28.7460	82.550 3.2500	6.4 .25	50.64 kg 111.65 lb	120.650 4.7500	672875D : GROOVE IN OD CENTER HOLES IN OD CENTER
EE671801	457.200 18.0000	114.300 4.5000	9.7 .38	- -	*672875D	730.148 28.7460	177.800 7.0000	1.5 .06	109.23 kg 240.85 lb	254.000 10.0000	
<b>L670800 Series</b>											
*L670847D <sub>GW</sub>	457.200 18.0000	138.112 5.4375	1.5 .06	- -	*L670814X	596.900 23.5000	57.183 2.2513	2.0 .08	13.01 kg 28.69 lb	142.052 5.5926	L670847D <sub>GW</sub> : ASYMMETRICAL BEARING GROOVE IN ID SHOULDER ON ID RIGHTSIDE
					*L670814W	596.900 23.5000	52.342 2.0607	6.4 .25	12.73 kg 28.08 lb	132.370 5.2114	L670814W : CHAMFER ON BACKFACE OD CHAMFER ON FRONTFACE OD SLOTS IN BACKFACE
											L670814X : CHAMFER ON BACKFACE OD CHAMFER ON FRONTFACE OD SHOULDER ON OD BACKFACE

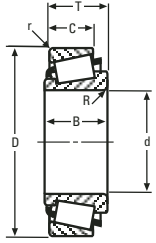

SINGLE ROW



SINGLE ROW WITH FLANGE

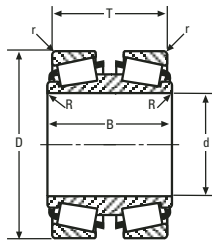

DOUBLE CONE

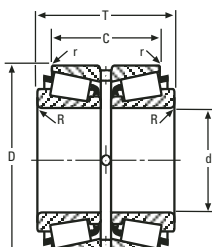

DOUBLE CUP

LM671600 SERIES CONTINUED ON NEXT PAGE

\*\*These Maximum Fillet Radii will be cleared by the Cone or Cup Radii.  
†Bore or O.D. shown are maximum dimensions. \*See Remarks Column.



LM671600 – XR699000 SERIES

CONE				Weight	CUP			Max Hs'ng Fillet Radii r''	Weight	BEARING WIDTH T	Remarks
Number	BORE d	WIDTH B	Max Shaft Fillet Radii R''		Number	OUTSIDE DIA D	WIDTH C				
<b>LM671600 Series</b>											
LM671644	463.550 18.2500	96.838 3.8125	6.4 .25	55.35 kg 122.05 lb	LM671610	622.300 24.5000	79.375 3.1250	6.4 .25	26.83 kg 59.15 lb	101.206 3.9845	LM671649TD: REVERSE TAPERED BORE
*LM671649TD	469.900 18.5000	254.000 10.0000	3.3 .13	- -	LM671610	622.300 24.5000	79.375 3.1250	6.4 .25	26.83 kg 59.15 lb	254.000 10.0000	
<b>LM672100 Series</b>											
*LM672148DGW	482.600 19.0000	203.200 8.0000	.8 .03	92.80 kg 204.63 lb	*LM672110	615.950 24.2500	55.298 2.1771	1.0 .04	11.24 kg 24.79 lb	135.250 5.3248	LM672148DGW: ASYMMETRICAL BEARING GROOVE IN ID SHOULDER ON ID RIGHTSIDE SLOTS IN LEFTFACE  LM672149DGW: ASYMMETRICAL BEARING GROOVE IN ID SHOULDER ON ID RIGHTSIDE SLOTS IN LEFTFACE
*LM672149DGW	482.600 19.0000	165.100 6.5000	.8 .03	86.19 kg 190.05 lb	*LM672111	615.950 24.2500	80.711 3.1776	6.4 .25	18.86 kg 41.58 lb	186.075 7.3258	
<b>LM672110 : SHOULDER ON OD BACKFACE</b>											
<b>LM672111 : GROOVE IN OD CENTER SHOULDER ON ID BACKFACE</b>											
<b>XR678000 Series</b>											
SEE CROSSED ROLLER BEARING SECTION											
<b>680000 Series</b>											
680235	596.900 23.5000	31.750 1.2500	3.5 .14	10.98 kg 24.22 lb	*680270-B	685.800 27.0000	25.400 1.0000	3.3 .13	6.20 kg 13.68 lb	13.492 .5312	680270-B : FLANGE ON OD FRONTFACE, BEARING WIDTH IS T1 DIMENSION
					680270	685.800 27.0000	25.400 1.0000	3.3 .13	5.77 kg 12.73 lb	31.750 1.2500	
<b>LL686900 Series</b>											
LL686947	914.400 36.0000	63.500 2.5000	6.4 .25	- -	*LL686910DC	1066.800 42.0000	101.600 4.0000	3.3 .13	56.74 kg 125.11 lb	139.700 5.5000	LL686910D : GROOVE IN OD CENTER HOLES IN OD CENTER
					*LL686910D	1066.800 42.0000	101.600 4.0000	3.3 .13	58.10 kg 128.10 lb	139.700 5.5000	LL686910DC : HOLES IN OD CENTER
<b>L687600 Series</b>											
L687645	950.000 37.4016	158.000 6.2205	6.4 .25	- -	*L687617X	1232.000 48.5039	130.000 5.1181	2.0 .08	180.50 kg 397.99 lb	158.000 6.2205	L687617X : CHAMFER ON BACKFACE OD HOLES IN FRONTFACE SHOULDER ON OD BACKFACE
					*L687617XA	1232.000 48.5039	130.000 5.1181	8.0 .31	183.32 kg 404.22 lb	28.000 1.1024	L687617XA : CHAMFER ON BACKFACE OD FLANGE ON OD FRONTFACE, BEARING WIDTH IS T1 DIMENSION SHOULDER ON OD BACKFACE
					*L687619X	1270.000 50.0000	130.000 5.1181	- -	254.37 kg 560.88 lb	158.000 6.2205	L687619X : CHAMFER ON BACKFACE OD SHOULDER ON OD BACKFACE
<b>LL687900 Series</b>											
LL687949	977.900 38.5000	63.500 2.5000	6.4 .25	- -	LL687910	1130.300 44.5000	47.625 1.8750	6.4 .25	27.67 kg 61.01 lb	66.675 2.6250	LL687910D : GROOVE IN OD CENTER HOLES IN OD CENTER
					*LL687910D	1130.300 44.5000	101.600 4.0000	3.3 .13	59.14 kg 130.40 lb	139.700 5.5000	
<b>690000 Series</b>											
EE690296D	749.300 29.5000	355.600 14.0000	6.4 .25	- -	690465	1181.100 46.5000	146.050 5.7500	12.7 .50	241.05 kg 531.51 lb	355.600 14.0000	
<b>XR699000 Series</b>											
SEE CROSSED ROLLER BEARING SECTION											

\*\*These Maximum Fillet Radii will be cleared by the Cone or Cup Radii.  
†Bore or O.D. shown are maximum dimensions. \*See Remarks Column.

70000 – LL713100 SERIES

CONE			Max Shaft Fillet Radii R <sup>**</sup>	Weight	CUP			Max Hs'ng Fillet Radii r <sup>**</sup>	Weight	BEARING	Remarks
Number	BORE d	WIDTH B			Number	OUTSIDE DIA D	WIDTH C			WIDTH T	
<b>70000 Series</b>											
EE700090D	228.600 9.0000	165.100 6.5000	3.5 .14	87.79 kg 193.57 lb	700167	425.450 16.7500	76.200 3.0000	6.4 .25	21.31 kg 46.98 lb	177.800 7.0000	700168D : GROOVE IN OD CENTER HOLES IN OD CENTER  700168DC : HOLES IN OD CENTER
EE700091	228.600 9.0000	95.250 3.7500	7.0 .28	36.56 kg 80.62 lb	700167	425.450 16.7500	76.200 3.0000	6.4 .25	21.31 kg 46.98 lb	101.600 4.0000	700177DS : HOLES IN OD CENTER
					*700168DC	425.450 16.7500	158.750 6.2500	1.5 .06	45.66 kg 100.69 lb	209.550 8.2500	
					*700168D	425.450 16.7500	158.750 6.2500	1.5 .06	45.46 kg 100.24 lb	209.550 8.2500	
					*700177DS	450.850 17.7500	158.750 6.2500	1.5 .06	65.49 kg 144.41 lb	209.550 8.2500	
<b>LM704600 Series</b>											
*†JLM704649	50.000 1.9685	22.000 .8661	3.5 .14	.30 kg .67 lb	†JLM704610	84.000 3.3071	17.500 .6890	1.5 .06	.16 kg .35 lb	22.000 .8661	JLM704649: FRONTFACE CHAMFER
					†JLM704611	84.000 3.3071	19.500 .7677	1.5 .06	.19 kg .42 lb	23.998 .9448	
<b>71000 Series</b>											
*710800	203.200 8.0000	52.004 2.0474	7.0 .28	-	711574	399.928 15.7452	54.000 2.1260	3.3 .13	10.35 kg 22.83 lb	72.000 2.8347	710800: NO SMALL RIB
EE710806	203.200 8.0000	61.912 2.4375	7.0 .28	-	711600	406.400 16.0000	39.688 1.5625	6.4 .25	8.63 kg 19.03 lb	63.500 2.5000	710900: NO SMALL RIB
EE710865	219.916 8.6581	61.912 2.4375	7.0 .28	-							710902D: NO SMALL RIB
*710900	228.600 9.0000	52.004 2.0474	7.0 .28	-							
EE710905	227.330 8.9500	61.912 2.4375	7.0 .28	-							
EE710906	228.600 9.0000	61.912 2.4375	7.0 .28	-							
*710902D	228.600 9.0000	91.308 3.5948	3.3 .13	-	711574	399.928 15.7452	54.000 2.1260	3.3 .13	10.35 kg 22.83 lb	131.302 5.1694	
					711600	406.400 16.0000	39.688 1.5625	6.4 .25	8.63 kg 19.03 lb	114.300 4.5000	
<b>LM710900 Series</b>											
†JLM710949C	65.000 2.5591	23.000 .9055	3.0 .12	.52 kg 1.14 lb	†JLM710910	105.000 4.1339	18.500 .7283	1.0 .04	.23 kg .52 lb	24.000 .9449	
<b>L713000 Series</b>											
L713049	69.850 2.7500	19.050 .7500	1.5 .06	.34 kg .75 lb	L713010	101.600 4.0000	15.083 .5938	1.5 .06	.17 kg .38 lb	19.050 .7500	L713049DA: ASYMMETRICAL BEARING
L713049A	69.850 2.7500	19.050 .7500	1.5 .06	.34 kg .74 lb	L713012	103.188 4.0625	15.083 .5938	1.5 .06	.20 kg .45 lb	19.050 .7500	L713049DAV: ASYMMETRICAL BEARING MADE FROM VACUUM MELT STEEL
					*L713012DC	103.188 4.0625	49.215 1.9376	.8 .03	.78 kg 1.71 lb	57.149 2.2500	L713012DC : HOLES IN OD CENTER
					*L713012DE	103.188 4.0625	49.215 1.9376	.8 .03	.73 kg 1.60 lb	57.149 2.2500	L713012DE : GROOVE IN OD CENTER HOLES IN OD CENTER
					*L713012DEV	103.188 4.0625	49.215 1.9376	.8 .03	.73 kg 1.60 lb	57.149 2.2500	L713012DEV : GROOVE IN OD CENTER HOLES IN OD CENTER MADE FROM VACUUM MELT STEEL
					*L713012V	103.188 4.0625	15.083 .5938	1.5 .06	.20 kg .45 lb	19.050 .7500	L713012V : MADE FROM VACUUM MELT STEEL
*L713049DA	69.850 2.7500	44.450 1.7500	1.5 .06	.95 kg 2.09 lb	L713010	101.600 4.0000	15.083 .5938	1.5 .06	.17 kg .38 lb	38.100 1.5000	
*L713049DAV	69.850 2.7500	44.450 1.7500	1.5 .06	.95 kg 2.10 lb	L713012	103.188 4.0625	15.083 .5938	1.5 .06	.20 kg .45 lb	38.100 1.5000	
					*L713012V	103.188 4.0625	15.083 .5938	1.5 .06	.20 kg .45 lb	38.100 1.5000	
<b>LL713100 Series</b>											
LL713149	69.850 2.7500	16.000 .6299	1.5 .06	.25 kg .55 lb	LL713110	99.217 3.9062	13.000 .5118	1.5 .06	.13 kg .30 lb	17.000 .6693	

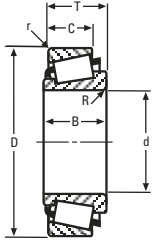

SINGLE ROW

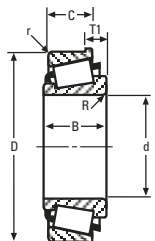

SINGLE ROW WITH FLANGE

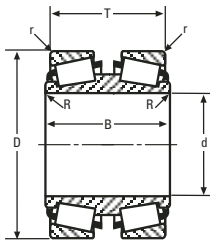

DOUBLE CONE

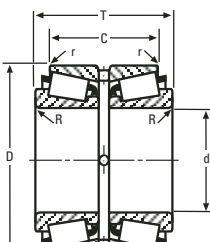

DOUBLE CUP

LM714100 SERIES CONTINUED ON NEXT PAGE

\*\*These Maximum Fillet Radii will be cleared by the Cone or Cup Radii.  
†Bore or O.D. shown are maximum dimensions. \*See Remarks Column.

LM714100 – M716600 SERIES

CONE				Weight	CUP			Max Hs'ng Fillet Radii r''	Weight	BEARING WIDTH T	Remarks
Number	BORE d	WIDTH B	Max Shaft Fillet Radii R''		Number	OUTSIDE DIA D	WIDTH C				
<b>LM714100 Series</b>											
†JLM714149	75.000 2.9528	25.000 .9843	3.0 .12	.61 kg 1.34 lb	†JLM714110	115.000 4.5276	19.000 .7480	2.5 .10	.27 kg .58 lb	25.000 .9843	JLM714149A: FRONTFACE CHAMFER
*†JLM714149A	75.000 2.9528	25.000 .9843	5.0 .20	.61 kg 1.34 lb							
<b>M714200 Series</b>											
†JM714249	75.000 2.9528	29.500 1.1614	3.0 .12	.88 kg 1.93 lb	†JM714210	120.000 4.7244	25.000 .9843	2.5 .10	.42 kg .94 lb	31.000 1.2205	
†JM714249A	75.000 2.9528	29.500 1.1614	6.0 .24	.85 kg 1.87 lb	†JM714210A	120.000 4.7244	25.000 .9843	1.0 .04	.44 kg .96 lb	31.000 1.2205	
<b>LL714600 Series</b>											
LL714649	76.200 3.0000	13.495 .5313	1.5 .06	.23 kg .51 lb	LL714610	105.570 4.1563	9.525 .3750	1.5 .06	.10 kg .21 lb	13.495 .5313	LL714610D : GROOVE IN OD CENTER HOLES IN OD CENTER
					*LL714610D	105.570 4.1563	23.810 .9374	.8 .03	.23 kg .51 lb	31.750 1.2500	
<b>H715300 Series</b>											
*H715332	60.325 2.3750	46.038 1.8125	3.5 .14	2.57 kg 5.66 lb	H715310	139.700 5.5000	36.512 1.4375	3.3 .13	1.14 kg 2.52 lb	46.038 1.8125	H715332: FRONTFACE CHAMFER
*H715334	61.912 2.4375	46.038 1.8125	3.5 .14	2.51 kg 5.54 lb	*H715310-B	139.700 5.5000	36.512 1.4375	3.3 .13	1.33 kg 2.94 lb	17.462 .6875	H715334: FRONTFACE CHAMFER H715336: FRONTFACE CHAMFER
*H715336	63.500 2.5000	46.038 1.8125	3.5 .14	2.46 kg 5.41 lb	H715311	136.525 5.3750	36.512 1.4375	3.3 .13	.96 kg 2.12 lb	46.038 1.8125	H715340: FRONTFACE CHAMFER
*H715340	65.088 2.5625	46.038 1.8125	3.5 .14	2.40 kg 5.29 lb	H715311A	136.525 5.3750	36.512 1.4375	.8 .03	.96 kg 2.13 lb	46.038 1.8125	H715341: FRONTFACE CHAMFER
*H715341	66.675 2.6250	46.038 1.8125	3.5 .14	2.34 kg 5.16 lb	H715311P	136.525 5.3750	36.512 1.4375	3.3 .13	.95 kg 2.09 lb	46.038 1.8125	H715341A: FRONTFACE CHAMFER
*H715341A	66.675 2.6250	46.038 1.8125	7.0 .28	2.32 kg 5.13 lb	*H715311W	136.525 5.3750	39.688 1.5625	3.3 .13	1.06 kg 2.34 lb	49.213 1.9375	H715343: FRONTFACE CHAMFER
*H715343	68.262 2.6875	46.038 1.8125	3.5 .14	2.28 kg 5.02 lb	*H715311XX	136.525 5.3750	36.512 1.4375	3.3 .13	.95 kg 2.09 lb	46.038 1.8125	H715344: FRONTFACE CHAMFER
*H715344	69.850 2.7500	46.038 1.8125	3.5 .14	2.22 kg 4.89 lb	*H715313W	136.525 5.3750	39.688 1.5625	3.3 .13	1.06 kg 2.34 lb	49.213 1.9375	H715345: FRONTFACE CHAMFER
*H715345	71.438 2.8125	46.038 1.8125	3.5 .14	2.16 kg 4.75 lb							H715345XX: MADE FROM VACUUM MELT STEEL
H715345P	71.438 2.8125	46.038 1.8125	3.5 .14	2.16 kg 4.75 lb							H715346: FRONTFACE CHAMFER
*H715345XX	71.438 2.8125	46.038 1.8125	3.5 .14	2.15 kg 4.73 lb							H715346XX: MADE FROM VACUUM MELT STEEL
*H715346	76.200 3.0000	46.038 1.8125	3.5 .14	1.96 kg 4.31 lb							H715347: FRONTFACE CHAMFER
H715346P	76.200 3.0000	46.038 1.8125	3.5 .14	1.96 kg 4.31 lb							H715348: FRONTFACE CHAMFER
*H715346XX	76.200 3.0000	46.038 1.8125	3.5 .14	1.95 kg 4.30 lb							H715348P: FRONTFACE CHAMFER
*H715347	69.987 2.7554	46.038 1.8125	3.5 .14	2.21 kg 4.87 lb							H715310-B : FLANGE ON OD FRONTFACE, BEARING WIDTH IS T1 DIMENSION
*H715348	77.788 3.0625	46.038 1.8125	3.5 .14	1.88 kg 4.15 lb							H715311W : KEYWAY BACKFACE
*H715348P	77.788 3.0625	46.038 1.8125	3.5 .14	1.88 kg 4.14 lb							H715311XX : MADE FROM VACUUM MELT STEEL H715313W : KEYWAY BACKFACE
<b>LM716400 Series</b>											
LM716446	79.974 3.1486	26.988 1.0625	3.5 .14	.89 kg 1.96 lb	LM716411	129.974 5.1171	20.638 .8125	1.5 .06	.41 kg .91 lb	26.987 1.0625	
LM716449	82.550 3.2500	26.988 1.0625	3.5 .14	.82 kg 1.80 lb	LM716412	130.175 5.1250	20.638 .8125	1.5 .06	.42 kg .92 lb	26.987 1.0625	
<b>M716600 Series</b>											
†JM716648	85.000 3.3465	29.000 1.1417	6.0 .24	.87 kg 1.92 lb	*†JM716610-B	130.000 5.1181	24.000 .9449	2.5 .10	.49 kg 1.08 lb	11.557 .4550	JM716610-B : FLANGE ON OD FRONTFACE, BEARING WIDTH IS T1 DIMENSION
†JM716649	85.000 3.3465	29.000 1.1417	3.0 .12	.90 kg 1.99 lb	†JM716610	130.000 5.1181	24.000 .9449	2.5 .10	.45 kg 1.00 lb	30.000 1.1811	
					†JM716615	135.000 5.3150	27.000 1.0630	2.5 .10	.78 kg 1.72 lb	33.000 1.2992	

\*\*These Maximum Fillet Radii will be cleared by the Cone or Cup Radii.  
†Bore or O.D. shown are maximum dimensions. \*See Remarks Column.

717000 – 724000 SERIES

CONE			Max Shaft Fillet Radii R''	Weight	CUP			Max Hs'ng Fillet Radii r''	Weight	BEARING WIDTH T	Remarks
Number	BORE d	WIDTH B			Number	OUTSIDE DIA D	WIDTH C				
<b>717000 Series</b>											
EE717065	165.100 6.5000	92.075 3.6250	3.3 .13	24.79 kg 54.67 lb	717132	336.550 13.2500	65.088 2.5625	6.4 .25	10.90 kg 24.04 lb	88.900 3.5000	717967: SPECIAL BACKFACE CHAMFER
*717967	165.100 6.5000	87.312 3.4375	12.7 .50	22.84 kg 50.37 lb							
<b>M718100 Series</b>											
†JM718149	90.000 3.5433	34.000 1.3386	3.0 .12	1.49 kg 3.29 lb	†JM718110	140.000 5.7087	27.000 1.0630	2.5 .10	.65 kg 1.43 lb	35.000 1.3780	
†JM718149A	90.000 3.5433	34.000 1.3386	6.0 .24	1.48 kg 3.26 lb							
<b>LM718900 Series</b>											
LM718947	91.973 3.6210	30.000 1.1811	3.5 .14	1.15 kg 2.53 lb	LM718910	142.875 5.6250	22.000 .8661	3.3 .13	.48 kg 1.07 lb	30.000 1.1811	
<b>M719100 Series</b>											
†JM719149	95.000 3.7402	34.000 1.3386	3.0 .12	1.41 kg 3.10 lb	†JM719113	150.000 5.9055	27.000 1.0630	2.5 .10	.76 kg 1.68 lb	35.000 1.3780	
<b>720000 Series</b>											
EE720125	317.500 12.5000	136.525 5.3750	19.8 .78	- -	720236	596.900 23.5000	98.425 3.8750	6.4 .25	51.83 kg 114.29 lb	136.525 5.3750	
EE720128	325.438 12.8125	136.525 5.3750	6.4 .25	- -							
<b>HM720200 Series</b>											
†JHM720249	100.000 3.9370	40.000 1.5748	3.0 .12	2.04 kg 4.49 lb	†JHM720210	160.000 6.2992	32.000 1.2598	2.5 .10	.96 kg 2.12 lb	41.000 1.6142	
†JHM720249P	100.000 3.9370	40.000 1.5748	3.0 .12	2.07 kg 4.56 lb	†JHM720210P	160.000 6.2992	32.000 1.2598	2.5 .10	.97 kg 2.15 lb	41.000 1.6142	
<b>M720200 Series</b>											
*†JM720249	100.000 3.9370	35.000 1.3780	3.0 .12	1.61 kg 3.55 lb	*†JM720210	155.000 6.1024	28.000 1.1024	2.5 .10	.76 kg 1.68 lb	36.000 1.4173	JM720249: SPECIAL BACKFACE RADIUS JM720210: SPECIAL RADIUS ON BACKFACE OD SPECIAL RADIUS ON FRONTFACE OD
<b>LM720600 Series</b>											
LM720646	99.974 3.9360	25.400 1.0000	1.5 .06	.95 kg 2.10 lb	LM720610	146.050 5.7500	19.050 .7500	1.5 .06	.39 kg .85 lb	25.400 1.0000	
LM720648	101.600 4.0000	25.400 1.0000	1.5 .06	.90 kg 1.99 lb	LM720611	144.976 5.7077	19.050 .7500	1.5 .06	.35 kg .77 lb	25.400 1.0000	
<b>721000 Series</b>											
*EE721092D	228.600 9.0000	215.900 8.5000	6.4 .25	- -	*721162	406.400 16.0000	66.675 2.6250	.3 .01	14.78 kg 32.58 lb	160.338 6.3125	EE721092D: GROOVE IN ID CENTER HOLES IN OD CENTER INVERTED BEARING 721162: BROKEN CORNER ON BACKFACE OD SHOULDER ON OD BACKFACE
<b>722000 Series</b>											
EE722110	279.400 11.0000	93.662 3.6875	9.7 .38	38.82 kg 85.60 lb	722185	469.900 18.5000	69.850 2.7500	3.3 .13	20.67 kg 45.58 lb	95.250 3.7500	722186CD: GROOVE IN OD CENTER HOLES IN OD CENTER
EE722115	292.100 11.5000	93.662 3.6875	9.7 .38	34.63 kg 76.35 lb	*722186CD	469.900 18.5000	149.225 5.8750	1.5 .06	41.79 kg 92.16 lb	200.025 7.8750	
EE722111D	279.400 11.0000	166.688 6.5625	6.4 .25	89.90 kg 198.23 lb	722185	469.900 18.5000	69.850 2.7500	3.3 .13	20.67 kg 45.58 lb	169.862 6.6875	
EE722112D	279.400 11.0000	184.150 7.2500	9.7 .38	97.85 kg 215.77 lb	EE722112D may be paired with all single cups corresponding to EE722111D and will require 20.638 mm (.8125 in) to be added to the T-width values.						
<b>LM722900 Series</b>											
*†JLM722947	115.000 4.5276	27.000 1.0630	2.5 .10	1.11 kg 2.46 lb	LM722910	161.925 6.3750	20.638 .8125	3.3 .13	.49 kg 1.07 lb	27.783 1.0938	JLM722947: HOLES IN BACKFACE TO UNDERCUT
†JLM722948	115.000 4.5276	27.000 1.0630	3.3 .13	1.11 kg 2.46 lb	*†JLM722912-B	165.000 6.4961	21.000 .8268	3.0 .12	.72 kg 1.59 lb	12.500 .4921	JLM722912-B: FLANGE ON OD FRONTFACE, BEARING WIDTH IS T1 DIMENSION
LM722949	114.300 4.5000	27.000 1.0630	3.3 .13	1.13 kg 2.49 lb	†JLM722912	165.000 6.4961	21.000 .8268	3.0 .12	.64 kg 1.41 lb	28.000 1.1024	
<b>724000 Series</b>											
EE724119	304.800 12.0000	92.075 3.6250	16.0 .63	- -	724191	488.950 19.2500	63.500 2.5000	3.3 .13	17.54 kg 38.68 lb	92.075 3.6250	724196CD: GROOVE IN OD CENTER HOLES IN OD CENTER

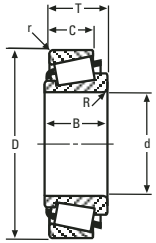

SINGLE ROW

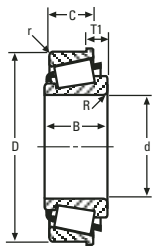

SINGLE ROW WITH FLANGE

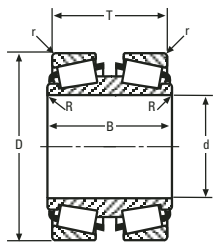

DOUBLE CONE

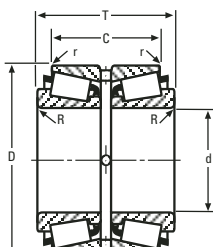

DOUBLE CUP

724000 SERIES CONTINUED ON NEXT PAGE

\*\*These Maximum Fillet Radii will be cleared by the Cone or Cup Radii.  
†Bore or O.D. shown are maximum dimensions. \*See Remarks Column.

CONE			Max Shaft Fillet Radii R''	Weight	CUP			Max Hs'ng Fillet Radii r''	Weight	BEAR-ING	Remarks
Number	BORE d	WIDTH B			Number	OUTSIDE DIA D	WIDTH C			WIDTH T	
<b>724000 Series (cont)</b>											
EE724120	304.800 12.0000	92.075 3.6250	16.0 .63	41.41 kg 91.31 lb	724195	495.300 19.5000	69.850 2.7500	6.4 .25	21.91 kg 48.32 lb	95.250 3.7500	
					*724196CD	495.300 19.5000	146.050 5.7500	1.5 .06	44.62 kg 98.38 lb	196.850 7.7500	
EE724121D	304.800 12.0000	165.100 6.5000	3.3 .13	95.34 kg 210.23 lb	724191	488.950 19.2500	63.500 2.5000	3.3 .13	17.54 kg 38.68 lb	165.100 6.5000	
					724195	495.300 19.5000	69.850 2.7500	6.4 .25	21.91 kg 48.32 lb	171.450 6.7500	
<b>L724300 Series</b>											
†JL724346	115.000 4.5276	25.400 1.0000	3.3 .13	1.31 kg 2.90 lb	L724310	166.688 6.5625	19.050 .7500	3.3 .13	.45 kg .98 lb	25.400 1.0000	JL724314-B : FLANGE ON OD FRONTFACE, BEARING WIDTH IS T1 DIMENSION
†JL724348	120.000 4.7244	25.400 1.0000	3.3 .13	1.10 kg 2.43 lb	*†JL724314-B	170.000 6.6929	19.050 .7500	3.3 .13	.65 kg 1.44 lb	11.351 .4469	
L724349	120.650 4.7500	25.400 1.0000	3.3 .13	1.10 kg 2.42 lb	†JL724314	170.000 6.6929	19.050 .7500	3.3 .13	.58 kg 1.27 lb	25.400 1.0000	
<b>L725300 Series</b>											
†JL725346	125.000 4.9213	25.400 1.0000	3.3 .13	1.14 kg 2.50 lb	*L725311V	171.450 6.7500	18.288 .7200	3.3 .13	.44 kg .96 lb	25.400 1.0000	L725349V: MADE FROM VACUUM MELT STEEL L725311V : MADE FROM VACUUM MELT STEEL
L725349	127.000 5.0000	25.400 1.0000	3.3 .13	1.07 kg 2.36 lb	L725311	171.450 6.7500	18.288 .7200	3.3 .13	.44 kg .96 lb	25.400 1.0000	SPECIAL RADIUS ON BACKFACE OD
*L725349V	127.000 5.0000	25.400 1.0000	3.3 .13	1.07 kg 2.36 lb	†JL725316	175.000 6.8898	18.288 .7200	3.3 .13	.56 kg 1.24 lb	25.400 1.0000	SPECIAL RADIUS ON FRONTFACE OD
<b>726000 Series</b>											
*EE726182TD	457.200 18.0000	330.200 13.0000	6.4 .25	- -	726287	730.148 28.7460	114.300 4.5000	6.4 .25	68.00 kg 149.94 lb	330.200 13.0000	EE726182TD: TAPERED BORE
<b>L730600 Series</b>											
†JL730646	150.000 5.9055	28.575 1.1250	3.3 .13	1.88 kg 4.14 lb	L730610	203.200 8.0000	21.438 .8440	3.3 .13	.69 kg 1.53 lb	28.575 1.1250	JL730612-B : FLANGE ON OD FRONTFACE, BEARING WIDTH IS T1 DIMENSION
L730649	152.400 6.0000	28.575 1.1250	3.3 .13	1.74 kg 3.84 lb	*†JL730612-B	205.000 8.0709	21.438 .8440	3.3 .13	.88 kg 1.94 lb	12.000 .4724	
					†JL730612	205.000 8.0709	21.438 .8440	3.3 .13	.82 kg 1.81 lb	28.575 1.1250	
<b>731000 Series</b>											
*EE731295D	749.300 29.5000	328.612 12.9375	6.4 .25	- -	731437	1110.000 43.7008	127.000 5.0000	9.7 .38	136.69 kg 301.41 lb	328.612 12.9375	EE731295D: HOLES IN OD CENTER
EE731296D	749.300 29.5000	328.612 12.9375	6.4 .25	- -	731445	1130.300 44.5000	127.000 5.0000	9.7 .38	171.76 kg 378.72 lb	328.612 12.9375	
EE731300DW	762.000 30.0000	328.612 12.9375	6.4 .25	- -							
<b>HM731600 Series</b>											
HM731649	152.400 6.0000	49.212 1.9375	3.5 .14	- -	*HM731610D	239.712 9.4375	84.138 3.3125	.8 .03	5.32 kg 11.73 lb	109.537 4.3125	HM731610D : GROOVE IN OD CENTER HOLES IN OD CENTER
					*HM731610DC	239.712 9.4375	84.138 3.3125	.8 .03	5.32 kg 11.73 lb	109.537 4.3125	HM731610DC : HOLES IN OD CENTER
<b>M734400 Series</b>											
†JM734445	160.000 6.2992	44.500 1.7520	3.0 .12	5.18 kg 11.43 lb	†JM734410	240.000 9.4488	37.000 1.4567	2.5 .10	2.00 kg 4.40 lb	46.000 1.8110	JM734449V: MADE FROM VACUUM MELT STEEL
†JM734449	170.000 6.6929	44.500 1.7520	3.0 .12	4.28 kg 9.44 lb	*†JM734410V	240.000 9.4488	37.000 1.4567	2.5 .10	2.00 kg 4.40 lb	46.000 1.8110	JM734410V : MADE FROM VACUUM MELT STEEL
†JM734449A	170.000 6.6929	44.500 1.7520	3.0 .12	4.29 kg 9.45 lb	†JM734411	241.000 9.4882	42.000 1.6535	2.5 .10	2.53 kg 5.58 lb	50.998 2.0078	
*†JM734449V	170.000 6.6929	44.500 1.7520	3.0 .12	4.28 kg 9.44 lb							
<b>LL735400 Series</b>											
LL735448	177.800 7.0000	23.812 .9375	1.5 .06	1.13 kg 2.49 lb	LL735410	215.900 8.5000	15.083 .5938	1.5 .06	.40 kg .89 lb	20.638 .8125	
LL735449	177.800 7.0000	20.638 .8125	1.5 .06	1.04 kg 2.29 lb							
<b>736000 Series</b>											
EE736160	406.400 16.0000	79.375 3.1250	8.0 .31	- -	736237	609.524 23.9970	65.088 2.5625	6.4 .25	22.46 kg 49.52 lb	87.312 3.4375	EE736170T: TAPERED BORE 736239D : GROOVE IN OD CENTER HOLES IN OD CENTER

9

\*These Maximum Fillet Radii will be cleared by the Cone or Cup Radii.  
†Bore or O.D. shown are maximum dimensions. \*See Remarks Column.

736000 – LM739700 SERIES

CONE			Max Shaft Fillet Radii R <sup>**</sup>	Weight	CUP			Max Hs'ng Fillet Radii r <sup>**</sup>	Weight	BEARING WIDTH T	Remarks
Number	BORE d	WIDTH B			Number	OUTSIDE DIA D	WIDTH C				
<b>736000 Series (cont)</b>											
*EE736170T	431.800 17.0000	79.375 3.1250	8.0 .31	-	736238	609.524 23.9970	60.325 2.3750	6.4 .25	20.33 kg 44.83 lb	82.550 3.2500	736239DC : HOLES IN OD CENTER
					*736239DC	609.524 23.9970	133.350 5.2500	1.5 .06	46.27 kg 102.03 lb	177.800 7.0000	
					*736239D	609.524 23.9970	133.350 5.2500	1.5 .06	46.27 kg 102.03 lb	177.800 7.0000	
EE736173D	432.003 17.0080	152.400 6.0000	3.5 .14	-	736237	609.524 23.9970	65.088 2.5625	6.4 .25	22.46 kg 49.52 lb	161.925 6.3750	
					736238	609.524 23.9970	60.325 2.3750	6.4 .25	20.33 kg 44.83 lb	152.400 6.0000	
<b>XR736000 Series</b>											
SEE CROSSED ROLLER BEARING SECTION											
<b>M736100 Series</b>											
†JM736149	180.000 7.0866	45.000 1.7717	3.0 .12	4.57 kg 10.08 lb	†JM736110	250.000 9.8425	37.000 1.4567	2.5 .10	2.10 kg 4.62 lb	47.000 1.8504	
†JM736149A	180.000 7.0866	45.000 1.7717	9.5 .37	4.52 kg 9.98 lb	†JM736110RR	250.000 9.8425	37.000 1.4567	2.5 .10	2.09 kg 4.60 lb	47.000 1.8504	
†JM736149AA	180.000 7.0866	45.000 1.7717	7.5 .30	4.55 kg 10.04 lb							
†JM736149RR	180.000 7.0866	45.000 1.7717	3.0 .12	4.46 kg 9.83 lb							
<b>737000 Series</b>											
EE737173	441.325 17.3750	85.725 3.3750	10.5 .41	-	737260	660.400 26.0000	62.705 2.4687	6.4 .25	27.77 kg 61.24 lb	91.280 3.5937	EE737180XD: EXTENDED LARGE RIB EE737181X: EXTENDED SMALL RIB
EE737181	457.200 18.0000	85.725 3.3750	10.5 .41	-	*737261DC	660.400 26.0000	138.112 5.4375	1.5 .06	62.75 kg 138.36 lb	195.263 7.6875	737261D : GROOVE IN OD CENTER HOLES IN OD CENTER
*EE737181X	457.200 18.0000	91.262 3.5930	6.4 .25	-	*737261D	660.400 26.0000	138.112 5.4375	1.5 .06	62.75 kg 138.36 lb	195.263 7.6875	737261DC : HOLES IN OD CENTER
					737262	660.400 26.0000	63.500 2.5000	6.4 .25	28.15 kg 62.06 lb	92.075 3.6250	
EE737179D	457.200 18.0000	155.575 6.1250	3.3 .13	-	737260	660.400 26.0000	62.705 2.4687	6.4 .25	27.77 kg 61.24 lb	155.573 6.1249	
					737262	660.400 26.0000	63.500 2.5000	6.4 .25	28.15 kg 62.06 lb	157.163 6.1875	
*EE737180XD	457.200 18.0000	163.512 6.4375	6.4 .25	-	EE737180XD may be paired with all single cups corresponding to EE737179D and will require 7.938 mm (.3125 in) to be added to the T-width values.						
<b>738000 Series</b>											
EE738101D	254.000 10.0000	165.100 6.5000	3.3 .13	-	738172	438.150 17.2500	63.500 2.5000	6.4 .25	13.95 kg 30.75 lb	165.100 6.5000	
EE738101DH	254.000 10.0000	165.100 6.5000	3.3 .13	-							
<b>M738200 Series</b>											
†JM738249	190.000 7.4803	44.000 1.7323	3.0 .12	4.67 kg 10.30 lb	†JM738210	260.000 10.2362	36.500 1.4370	2.5 .10	2.20 kg 4.84 lb	46.000 1.8110	
†JM738249A	190.000 7.4803	44.000 1.7323	8.0 .31	4.54 kg 10.02 lb							
<b>LM739700 Series</b>											
*LM739749	196.850 7.7500	39.688 1.5625	3.5 .14	3.57 kg 7.87 lb	LM739710	257.175 10.1250	30.162 1.1875	3.3 .13	1.74 kg 3.84 lb	39.688 1.5625	LM739749: SPECIAL BACKFACE RADIUS LM739749WE: FRONTFACE CHAMFER SLOTS IN FRONTFACE
					*LM739710CD	257.175 10.1250	66.675 2.6250	.8 .03	3.90 kg 8.59 lb	85.725 3.3750	
					LM739719	266.700 10.5000	30.162 1.1875	3.3 .13	2.64 kg 5.82 lb	39.688 1.5625	LM739710CD : HOLES IN OD CENTER SPECIAL RADIUS ON LEFTFACE OD SPECIAL RADIUS ON RIGHTFACE OD
*LM739749WE	196.850 7.7500	43.023 1.6938	3.5 .14	3.68 kg 8.12 lb	LM739710	257.175 10.1250	30.162 1.1875	3.3 .13	1.74 kg 3.84 lb	39.688 1.5625	
					LM739719	266.700 10.5000	30.162 1.1875	3.3 .13	2.64 kg 5.82 lb	39.688 1.5625	

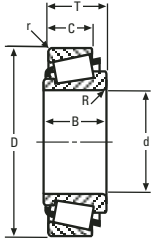

SINGLE ROW

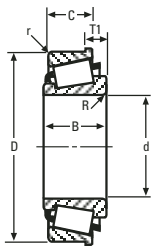

SINGLE ROW WITH FLANGE

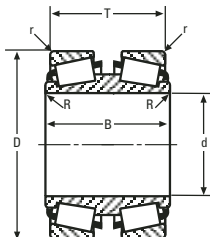

DOUBLE CONE

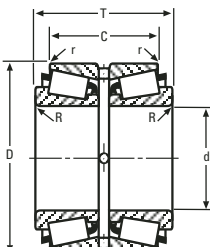

DOUBLE CUP

LM741300 – 743000 SERIES

CONE			Max Shaft Fillet Radii R <sup>**</sup>	Weight	CUP			Max Hs'ng Fillet Radii r <sup>**</sup>	Weight	BEARING WIDTH T	Remarks
Number	BORE d	WIDTH B			Number	OUTSIDE DIA D	WIDTH C				
<b>LM741300 Series</b>											
*LM741330T	196.187 7.7239	49.212 1.9375	3.3 .13	6.77 kg 14.92 lb	LM741314	279.400 11.0000	34.133 1.3438	3.3 .13	2.55 kg 5.62 lb	45.093 1.7753	LM741330T: REVERSE TAPERED BORE
*LM741349T	207.962 8.1875	49.212 1.9375	3.3 .13	5.34 kg 11.77 lb							LM741346TD: REVERSE TAPERED BORE TQI/TQO (NON-INTERLOCKING)
*LM741346TD	203.860 8.0260	92.075 3.6250	1.5 .06	14.11 kg 31.11 lb	LM741314	279.400 11.0000	34.133 1.3438	3.3 .13	2.55 kg 5.62 lb	83.835 3.3006	LM741349T: SPECIAL BACKFACE RADIUS SPECIAL FRONTFACE RADIUS TAPERED BORE
*LM741349TE	211.072 8.3099	86.517 3.4062	spcl. spcl.	9.00 kg 19.85 lb	LM741349TE may be paired with all single cups corresponding to LM741330T and will require 37.305 mm (1.4687 in) to be added to the T-width values.						
<b>LM742700 Series</b>											
*LM742738TD	209.781 8.2591	92.075 3.6250	1.6 .06	7.37 kg 16.26 lb	LM742710	285.750 11.2500	34.925 1.3750	3.3 .13	2.38 kg 5.25 lb	85.420 3.3630	LM742730T: REVERSE TAPERED BORE
*LM742746TD	214.973 8.4635	92.075 3.6250	1.5 .06	7.37 kg 16.26 lb	LM742714	288.925 11.3750	34.925 1.3750	3.3 .13	2.77 kg 6.11 lb	85.420 3.3630	LM742731T: REVERSE TAPERED BORE
LM742745	212.725 8.3750	46.038 1.8125	3.5 .14	5.69 kg 12.55 lb	*LM742710-B	285.750 11.2500	34.925 1.3750	3.3 .13	2.64 kg 5.83 lb	19.050 .7500	LM742738TD: TAPERED BORE TQI/TQO (NON-INTERLOCKING)
LM742748	215.900 8.5000	46.038 1.8125	3.5 .14	5.16 kg 11.38 lb	LM742710	285.750 11.2500	34.925 1.3750	3.3 .13	2.38 kg 5.25 lb	46.037 1.8125	LM742744T: TAPERED BORE
LM742749	215.900 8.5000	46.038 1.8125	3.5 .14	5.31 kg 11.70 lb	*LM742710CD	285.750 11.2500	76.200 3.0000	.8 .03	5.24 kg 11.55 lb	98.424 3.8750	LM742746TD: TAPERED BORE TQI/TQO (NON-INTERLOCKING)
LM742749AA	215.900 8.5000	46.038 1.8125	9.0 .35	5.28 kg 11.64 lb	LM742714	288.925 11.3750	34.925 1.3750	3.3 .13	2.77 kg 6.11 lb	46.037 1.8125	LM742747: FRONTFACE CHAMFER
					*LM742714D	288.925 11.3750	76.200 3.0000	.8 .03	6.06 kg 13.36 lb	98.424 3.8750	LM742749T: TAPERED BORE
					*LM742715D	289.954 11.4155	76.200 3.0000	.8 .03	6.14 kg 13.53 lb	98.424 3.8750	LM742710-B : FLANGE ON OD FRONTFACE, BEARING WIDTH IS T1 DIMENSION
*LM742747	216.408 8.5200	49.212 1.9375	3.5 .14	5.66 kg 12.47 lb	*LM742710-B	285.750 11.2500	34.925 1.3750	3.3 .13	2.64 kg 5.83 lb	19.050 .7500	LM742710CD : GROOVE IN OD CENTER HOLES IN OD CENTER
LM742747A	216.713 8.5320	49.212 1.9375	3.5 .14	5.62 kg 12.38 lb	LM742710	285.750 11.2500	34.925 1.3750	3.3 .13	2.38 kg 5.25 lb	46.037 1.8125	LM742714D : GROOVE IN OD CENTER HOLES IN OD CENTER
					LM742714	288.925 11.3750	34.925 1.3750	3.3 .13	2.77 kg 6.11 lb	46.037 1.8125	LM742715D : GROOVE IN OD CENTER HOLES IN OD CENTER
*LM742730T	207.300 8.1614	49.212 1.9375	3.3 .13	6.96 kg 15.36 lb	LM742730T and grouped cones may be paired with all single cups corresponding to LM742747 and will require -.152 mm (-.0060 in) to be added to the T-width values.						
*LM742731T	202.110 7.9571	49.212 1.9375	3.4 .14	7.59 kg 16.73 lb							
*LM742744T	213.883 8.4206	49.212 1.9375	3.2 .12	6.08 kg 13.41 lb							
*LM742749T	219.075 8.6250	49.212 1.9375	3.0 .12	5.45 kg 12.03 lb							
LM742749D	215.900 8.5000	85.725 3.3750	.8 .03	12.59 kg 27.76 lb	LM742749D and grouped cones may be paired with all single cups corresponding to LM742738TD and will require .305 mm (.0120 in) to be added to the T-width values.						
LM742749DW	215.900 8.5000	85.725 3.3750	2.3 .09	12.59 kg 27.76 lb							
<b>743000 Series</b>											
EE743240	609.600 24.0000	82.550 3.2500	6.4 .25	- -	743320	812.800 32.0000	60.325 2.3750	6.4 .25	34.94 kg 77.03 lb	82.550 3.2500	EE743241D: HOLES IN OD CENTER
					*743321DC	812.800 32.0000	146.050 5.7500	3.3 .13	90.74 kg 200.08 lb	190.500 7.5000	743321CD : GROOVE IN OD CENTER HOLES IN OD CENTER
					*743321D	812.800 32.0000	146.050 5.7500	3.3 .13	90.92 kg 200.47 lb	190.500 7.5000	743321D : GROOVE IN OD CENTER HOLES IN OD CENTER

9

\*\*These Maximum Fillet Radii will be cleared by the Cone or Cup Radii.  
†Bore or O.D. shown are maximum dimensions. \*See Remarks Column.

743000 – 752000 SERIES

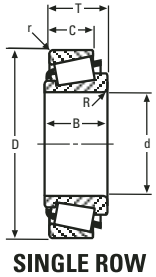

SINGLE ROW

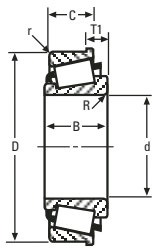

SINGLE ROW WITH FLANGE

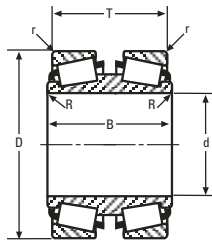

DOUBLE CONE

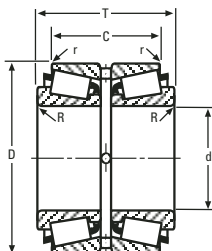

DOUBLE CUP

CONE			Max Shaft Fillet Radii R <sup>**</sup>	Weight	CUP			Max Hs'ng Fillet Radii r <sup>**</sup>	Weight	BEARING	Remarks
Number	BORE d	WIDTH B			Number	OUTSIDE DIA D	WIDTH C			WIDTH T	
743000 Series (cont)											
					*743321CD	812.800 32.0000	146.050 5.7500	3.3 .13	85.15 kg 187.77 lb	190.500 7.5000	743321DC : HOLES IN OD CENTER
*EE743241D	609.600 24.0000	190.500 7.5000	3.3 .13	-	743320	812.800 32.0000	60.325 2.3750	6.4 .25	34.94 kg 77.03 lb	190.500 7.5000	
HM743300 Series											
HM743337	200.025 7.8750	69.850 2.7500	6.4 .25	-	HM743310	333.375 13.1250	52.388 2.0625	6.4 .25	6.33 kg 13.96 lb	69.850 2.7500	HM743310CD : GROOVE IN OD CENTER HOLES IN OD CENTER
HM743345	209.550 8.2500	69.850 2.7500	6.4 .25	-	*HM743310CD	333.375 13.1250	114.300 4.5000	1.5 .06	13.87 kg 30.58 lb	149.224 5.8750	
HM746600 Series											
HM746645	228.600 9.0000	69.850 2.7500	6.4 .25	-	HM746610	355.600 14.0000	50.800 2.0000	6.4 .25	6.81 kg 15.02 lb	69.850 2.7500	HM746646H : GROOVE IN OD FRONTFACE NO SMALL RIB SHOULDER ON OD FRONTFACE
HM746646	228.600 9.0000	69.850 2.7500	6.4 .25	-	*HM746610CD	355.600 14.0000	114.300 4.5000	1.5 .06	15.42 kg 33.99 lb	152.400 6.0000	HM746610CD : GROOVE IN OD CENTER HOLES IN OD CENTER
*HM746646H	228.600 9.0000	69.850 2.7500	6.4 .25	17.54 kg 38.68 lb							
749000 Series											
EE749259DW	659.925 25.9813	151.900 5.9803	4.8 .19	-	749334	854.923 33.6584	59.898 2.3582	9.7 .38	33.23 kg 73.28 lb	151.188 5.9523	EE749259DWA : ASYMMETRICAL BEARING SLOTS IN RIGHTFACE
*EE749259DWA	659.925 25.9813	192.725 7.5876	5.0 .20	194.42 kg 428.70 lb	749336	854.075 33.6250	60.325 2.3750	6.4 .25	33.59 kg 74.06 lb	152.414 6.0005	749335CD : GROOVE IN OD CENTER HOLES IN OD CENTER
EE749260	660.400 26.0000	85.468 3.3649	9.7 .38	-	749334	854.923 33.6584	59.898 2.3582	9.7 .38	33.23 kg 73.28 lb	85.113 3.3509	
					*749335CD	854.923 33.6584	135.900 5.3504	2.3 .09	76.37 kg 168.38 lb	186.329 7.3358	
					749336	854.075 33.6250	60.325 2.3750	6.4 .25	33.59 kg 74.06 lb	85.726 3.3750	
750000 Series											
*750500	127.000 5.0000	55.804 2.1970	6.4 .25	-	751200	304.800 12.0000	41.275 1.6250	6.4 .25	6.45 kg 14.23 lb	60.325 2.3750	750500 : NO SMALL RIB
EE750502	127.000 5.0000	61.912 2.4375	6.4 .25	-	*751204DC	304.800 12.0000	97.633 3.8438	1.5 .06	15.61 kg 34.41 lb	135.732 5.3438	750550 : NO SMALL RIB 750552 : NO SMALL RIB
*750550	139.700 5.5000	55.804 2.1970	3.3 .13	-	*751204D	304.800 12.0000	97.633 3.8438	1.5 .06	15.61 kg 34.41 lb	135.732 5.3438	750556W : KEYWAY IN ID NO SMALL RIB
*750552	139.700 5.5000	55.804 2.1970	6.4 .25	-							EE750558W : KEYWAY IN ID
*750556W	139.700 5.5000	55.804 2.1970	3.3 .13	-							750575 : NO SMALL RIB
EE750558	139.700 5.5000	61.912 2.4375	3.3 .13	-							751204D : GROOVE IN OD CENTER HOLES IN OD CENTER
*EE750558W	139.700 5.5000	61.912 2.4375	3.3 .13	-							751204DC : HOLES IN OD CENTER
EE750559W	139.700 5.5000	61.912 2.4375	3.3 .13	-							
EE750562	139.700 5.5000	61.912 2.4375	6.4 .25	-							
EE750573	146.050 5.7500	61.912 2.4375	12.7 .50	-							
*750575	146.050 5.7500	55.804 2.1970	3.3 .13	-							
EE750576	146.050 5.7500	61.912 2.4375	3.3 .13	-							
EE750577	146.050 5.7500	61.912 2.4375	6.4 .25	-							
752000 Series											
EE752295	749.300 29.5000	80.962 3.1875	6.4 .25	-	752380	965.200 38.0000	66.675 2.6250	3.3 .13	45.53 kg 100.39 lb	93.663 3.6875	752381D : GROOVE IN OD CENTER HOLES IN OD CENTER
EE752300	762.000 30.0000	80.962 3.1875	6.4 .25	-	*752381DC	965.200 38.0000	133.350 5.2500	1.5 .06	91.49 kg 201.73 lb	187.325 7.3750	752381DC : HOLES IN OD CENTER
EE752305	774.700 30.5000	80.962 3.1875	6.4 .25	-	*752381D	965.200 38.0000	133.350 5.2500	1.5 .06	91.49 kg 201.73 lb	187.325 7.3750	
EE752306	774.700 30.5000	80.962 3.1875	6.4 .25	-							

755000 SERIES CONTINUED ON NEXT PAGE

\*\*These Maximum Fillet Radii will be cleared by the Cone or Cup Radii.  
†Bore or O.D. shown are maximum dimensions. \*See Remarks Column.



755000 – LM761600 SERIES

CONE			Max Shaft Fillet Radii R''	Weight	CUP			Max Hs'ng Fillet Radii r''	Weight	BEARING WIDTH T	Remarks
Number	BORE d	WIDTH B			Number	OUTSIDE DIA D	WIDTH C				
<b>755000 Series</b>											
*755279DGWA	711.200 28.0000	203.200 8.0000	8.0 .31	230.28 kg 507.77 lb	755360	914.400 36.0000	60.325 2.3750	6.4 .25	34.33 kg 75.70 lb	149.225 5.8750	755279DGWA: ASYMMETRICAL BEARING GROOVE IN ID SHOULDER ON OD RIGHTFACE SLOTS IN LEFTFACE
*EE755279DWA	711.200 28.0000	203.200 8.0000	8.0 .31	233.95 kg 515.86 lb	755363	927.100 36.5000	60.325 2.3750	6.4 .25	43.72 kg 96.40 lb	149.225 5.8750	
*EE755280DGW	711.200 28.0000	149.225 5.8750	16.0 .63	- -							EE755279DWA: ASYMMETRICAL BEARING SHOULDER ON OD RIGHTFACE SLOTS IN LEFTFACE
EE755280DW	711.200 28.0000	149.225 5.8750	16.0 .63	- -							
EE755281D	711.200 28.0000	149.225 5.8750	3.3 .13	- -							EE755280DGW: GROOVE IN ID
EE755282	719.930 28.3437	80.962 3.1875	4.8 .19	- -	755358XD	914.906 36.0199	139.903 5.5080	1.5 .06	85.43 kg 188.37 lb	189.240 7.4504	755361CD : GROOVE IN OD CENTER HOLES IN OD CENTER
EE755285	723.900 28.5000	80.962 3.1875	5.5 .22	- -	755360	914.400 36.0000	60.325 2.3750	6.4 .25	34.33 kg 75.70 lb	84.137 3.3125	755365CD : GROOVE IN OD CENTER HOLES IN OD CENTER
					*755361CD	914.400 36.0000	139.700 5.5000	3.3 .13	85.07 kg 187.57 lb	187.325 7.3750	755367CD : GROOVE IN OD CENTER HOLES IN OD CENTER
					755363	927.100 36.5000	60.325 2.3750	6.4 .25	43.72 kg 96.40 lb	84.137 3.3125	
					*755365CD	977.900 38.5000	139.700 5.5000	3.3 .13	181.91 kg 401.12 lb	187.325 7.3750	
					*755367CD	1003.300 39.5000	139.700 5.5000	3.3 .13	224.85 kg 495.79 lb	187.325 7.3750	
EE755280	711.200 28.0000	82.550 3.2500	6.4 .25	- -							EE755280 may be paired with all single cups corresponding to EE755282 and will require 1.588 mm (.0625 in) to be added to the T-width values. EE755280 may be paired with all double cups corresponding to EE755282 and will require 3.175 mm (.1250 in) to be added to the T-width values.
<b>LM757000 Series</b>											
*LM757043TD	295.275 11.6250	203.200 8.0000	1.5 .06	71.73 kg 158.16 lb	LM757010	406.400 16.0000	47.625 1.8750	3.3 .13	6.85 kg 15.10 lb	203.200 8.0000	LM757043TD: TAPERED BORE LM757010-B : FLANGE ON OD FRONTFACE, BEARING WIDTH IS T1 DIMENSION
LM757049	304.800 12.0000	63.500 2.5000	6.4 .25	14.61 kg 32.22 lb	*LM757010-B	406.400 16.0000	47.625 1.8750	3.3 .13	7.34 kg 16.19 lb	25.400 1.0000	
LM757049A	305.054 12.0100	63.500 2.5000	6.4 .25	14.52 kg 32.02 lb	LM757010	406.400 16.0000	47.625 1.8750	3.3 .13	6.85 kg 15.10 lb	63.500 2.5000	
LM757049AA	304.800 12.0000	63.500 2.5000	12.7 .50	14.54 kg 32.05 lb							
<b>M757400 Series</b>											
M757447D	304.648 11.9940	128.587 5.0625	3.3 .13	51.37 kg 113.27 lb	M757410	438.048 17.2460	53.975 2.1250	4.8 .19	9.95 kg 21.95 lb	138.113 5.4375	M757448D: ASYMMETRICAL BEARING M757448DW: SLOTS IN LEFTFACE
*M757448D	304.648 11.9940	134.145 5.2813	3.3 .13	51.91 kg 114.46 lb							M757449DW: ASYMMETRICAL BEARING SLOTS IN LEFTFACE
*M757448DW	304.648 11.9940	134.145 5.2813	3.3 .13	51.95 kg 114.54 lb							
*M757449DW	305.000 12.0079	134.145 5.2813	3.3 .13	51.74 kg 114.08 lb							
<b>LL758700 Series</b>											
LL758744	323.850 12.7500	28.575 1.1250	3.5 .14	3.78 kg 8.34 lb	LL758715	381.000 15.0000	20.638 .8125	3.3 .13	1.61 kg 3.55 lb	28.575 1.1250	
<b>LM761600 Series</b>											
*LM761642TD	331.960 13.0693	127.000 5.0000	1.5 .06	53.20 kg 117.30 lb	LM761610	457.098 17.9960	49.212 1.9375	3.3 .13	8.28 kg 18.25 lb	122.238 4.8125	LM761642TD: ASYMMETRICAL BEARING TAPERED BORE
LM761648DW	341.312 13.4375	122.238 4.8125	1.5 .06	45.27 kg 99.83 lb	*LM761611W	457.098 17.9960	50.975 2.0069	3.3 .13	8.91 kg 19.65 lb	125.763 4.9513	LM761647DGW: ASYMMETRICAL BEARING EXTENDED SMALL RIB
LM761649D	343.052 13.5060	122.238 4.8125	1.5 .06	44.37 kg 97.84 lb	*LM761611X	457.098 17.9960	53.040 2.0882	2.5 .10	8.45 kg 18.64 lb	129.893 5.1139	GROOVE IN ID SHOULDER ON ID LEFTSIDE
*LM761649DGE	343.052 13.5060	127.000 5.0000	1.5 .06	45.11 kg 99.48 lb	†JLM761614	459.948 18.1082	49.390 1.9445	3.3 .13	9.32 kg 20.54 lb	122.593 4.8265	JLM761648DG: EXTENDED SMALL RIB
*LM761649DGW	343.052 13.5060	122.238 4.8125	1.5 .06	44.37 kg 97.84 lb	*†JLM761614W	459.948 18.1082	50.975 2.0069	3.3 .13	9.75 kg 21.49 lb	125.763 4.9513	GROOVE IN ID SHOULDER ON ID LEFTSIDE SLOTS IN LEFTFACE
LM761649DW	343.052 13.5060	122.238 4.8125	1.5 .06	44.37 kg 97.84 lb							

9

†These Maximum Fillet Radii will be cleared by the Cone or Cup Radii.  
†Bore or O.D. shown are maximum dimensions. \*See Remarks Column.

**LM761600 – LM765100 SERIES**

CONE			Max Shaft Fillet Radii R <sup>**</sup>	Weight	CUP			Max Hs'ng Fillet Radii r <sup>**</sup>	Weight	BEARING WIDTH T	Remarks
Number	BORE d	WIDTH B			Number	OUTSIDE DIA D	WIDTH C				
<b>LM761600 Series (cont)</b>											
*LM761649DWA	343.052 13.5060	157.162 6.1875	1.5 .06	47.75 kg 105.29 lb							LM761649DGE: EXTENDED SMALL RIB GROOVE IN ID
*LM761649DWE	343.052 13.5060	127.000 5.0000	1.5 .06	45.11 kg 99.48 lb							LM761649DGW: GROOVE IN ID
LM761649DWH	343.052 13.5060	122.238 4.8125	1.5 .06	44.37 kg 97.84 lb							LM761649DWA: ASYMMETRICAL BEARING SHOULDER ON OD LEFTFACE SLOTS IN LEFTFACE
*LM761649TD	342.544 13.4860	127.000 5.0000	1.5 .06	48.08 kg 106.01 lb							LM761649DWE: ASYMMETRICAL BEARING EXTENDED SMALL RIB LM761649TD: ASYMMETRICAL BEARING REVERSE TAPERED BORE LM761611W: SLOTS IN BACKFACE LM761611X: SHOULDER ON OD BACKFACE JLM761614W: SLOTS IN BACKFACE
*LM761647DGW	343.052 13.5060	127.000 5.0000	1.5 .06	44.19 kg 97.44 lb	LM761647DGW and grouped cones may be paired with all single cups corresponding to LM761642TD and will require -.4178 mm (-.1645 in) to be added to the T-width values.						
*†JLM761648DG	343.000 13.5039	140.000 5.5118	4.3 .17	45.27 kg 99.82 lb							
<b>762000 Series</b>											
EE762320	812.800 32.0000	88.900 3.5000	6.4 .25	- -	*762401DC	1016.000 40.0000	146.050 5.7500	1.5 .06	102.71 kg 226.47 lb	190.500 7.5000	762401D: GROOVE IN OD CENTER HOLES IN OD CENTER
					*762401D	1016.000 40.0000	146.050 5.7500	1.5 .06	101.76 kg 224.39 lb	190.500 7.5000	762401DC: HOLES IN OD CENTER
					762420XD	1066.800 42.0000	146.050 5.7500	3.3 .13	206.93 kg 456.29 lb	190.500 7.5000	
<b>LL762600 Series</b>											
LL762648	361.950 14.2500	21.430 .8437	2.0 .08	1.84 kg 4.06 lb	LL762610	401.638 15.8125	15.875 .6250	2.0 .08	.83 kg 1.84 lb	21.430 .8437	
LL762649	361.950 14.2500	21.430 .8437	2.0 .08	2.15 kg 4.75 lb							
<b>763000 Series</b>											
EE763325	825.500 32.5000	88.900 3.5000	6.4 .25	- -	763410	1041.400 41.0000	66.675 2.6250	6.4 .25	49.15 kg 108.37 lb	93.662 3.6875	763410D: GROOVE IN OD CENTER HOLES IN OD CENTER
EE763329	836.612 32.9375	88.900 3.5000	6.4 .25	- -	*763410DC	1041.400 41.0000	123.825 4.8750	1.5 .06	93.85 kg 206.95 lb	190.500 7.5000	763410DC: HOLES IN OD CENTER
EE763330	838.200 33.0000	88.900 3.5000	6.4 .25	- -	*763410D	1041.400 41.0000	123.825 4.8750	1.5 .06	92.19 kg 203.29 lb	190.500 7.5000	
<b>LM763400 Series</b>											
*LM763446DGA	355.600 14.0000	165.100 6.5000	1.5 .06	58.87 kg 129.81 lb	LM763410	482.600 19.0000	52.388 2.0625	3.3 .13	10.73 kg 23.66 lb	133.350 5.2500	LM763446DGA: GROOVE IN ID SHOULDER ON ID RIGHTSIDE SLOTS IN LEFTFACE
*LM763448DWA	355.600 14.0000	161.133 6.3438	1.5 .06	58.74 kg 129.53 lb	LM763410A	482.600 19.0000	52.388 2.0625	6.4 .25	10.56 kg 23.28 lb	133.350 5.2500	LM763447DGW: GROOVE IN ID
LM763449D	355.600 14.0000	128.587 5.0625	1.5 .06	52.48 kg 115.72 lb	LM763410E	482.600 19.0000	53.975 2.1250	3.3 .13	11.07 kg 24.42 lb	136.525 5.3750	LM763448DWA: ASYMMETRICAL BEARING SLOTS IN LEFTFACE
*LM763449DGW	355.600 14.0000	128.587 5.0625	1.5 .06	52.43 kg 115.61 lb	*LM763410X	482.600 19.0000	52.388 2.0625	spcl. spcl.	10.08 kg 22.22 lb	133.350 5.2500	
LM763449DW	355.600 14.0000	128.587 5.0625	1.5 .06	52.48 kg 115.72 lb	*LM763411W	482.600 19.0000	52.753 2.0769	3.5 .14	10.87 kg 23.97 lb	134.082 5.2788	LM763449DGW: GROOVE IN ID
*LM763449DWA	355.600 14.0000	161.133 6.3438	1.5 .06	58.74 kg 129.53 lb	LM763412	482.600 19.0000	55.133 2.1706	3.5 .14	11.72 kg 25.84 lb	138.841 5.4662	LM763449DWA: ASYMMETRICAL BEARING SLOTS IN LEFTFACE
					LM763414	488.950 19.2500	50.005 1.9687	3.3 .13	11.96 kg 26.37 lb	128.585 5.0624	LM763410X: GROOVE IN OD CENTER SPECIAL CHAMFER ON BACKFACE OD LM763411W: SLOTS IN BACKFACE
*LM763447DGW	355.600 14.0000	132.558 5.2188	1.6 .06	54.03 kg 119.13 lb	LM763447DGW may be paired with all single cups corresponding to LM763446DGA and will require -1.524 mm (-.0600 in) to be added to the T-width values.						
<b>LM763800 Series</b>											
LM763848	361.950 14.2500	63.500 2.5000	3.3 .13	- -	*LM763811DC	477.838 18.8125	103.188 4.0625	1.5 .06	19.34 kg 42.65 lb	138.112 5.4375	LM763811DC: HOLES IN OD CENTER
<b>LM765100 Series</b>											
LM765148DW	374.650 14.7500	120.650 4.7500	3.3 .13	53.68 kg 118.36 lb	LM765110	501.650 19.7500	50.800 2.0000	3.3 .13	10.48 kg 23.10 lb	130.174 5.1250	

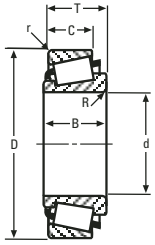

**SINGLE ROW**



**SINGLE ROW WITH FLANGE**

**9**

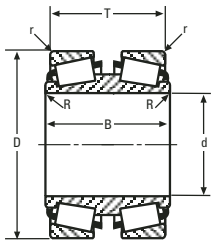

**DOUBLE CONE**

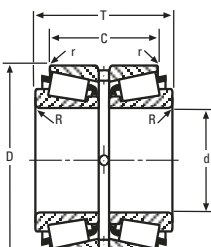

**DOUBLE CUP**

LM765100 – LM772700 SERIES

CONE			Max Shaft Fillet Radii R''	Weight	CUP			Max Hs'ng Fillet Radii r''	Weight	BEARING WIDTH T	Remarks
Number	BORE d	WIDTH B			Number	OUTSIDE DIA D	WIDTH C				
LM765100 Series (cont)											
LM765149D	374.650 14.7500	120.650 4.7500	1.5 .06	53.88 kg 118.81 lb	LM765111	499.745 19.6750	50.800 2.0000	3.3 .13	9.91 kg 21.85 lb	130.174 5.1250	
LM765149DW	374.650 14.7500	120.650 4.7500	1.5 .06	53.20 kg 117.31 lb							
XR766000 Series											
SEE CROSSED ROLLER BEARING SECTION											
LM767700 Series											
LM767745D	393.700 15.5000	138.112 5.4375	1.5 .06	81.79 kg 180.34 lb	LM767710	546.100 21.5000	53.975 2.1250	6.4 .25	13.10 kg 28.88 lb	138.112 5.4375	LM767747DGW: EXTENDED SMALL RIB GROOVE IN ID SHOULDER ON ID LEFTSIDE SLOTS IN RIGHTFACE
*LM767747DGW	406.400 16.0000	165.000 6.4961	1.5 .06	78.61 kg 173.34 lb							
LM767748D	406.400 16.0000	138.112 5.4375	1.5 .06	- -							LM767749DGW: GROOVE IN ID
LM767748DA	406.400 16.0000	138.112 5.4375	1.5 .06	- -							
LM767748DW	406.400 16.0000	138.112 5.4375	1.5 .06	73.47 kg 161.99 lb							
*LM767749DGW	406.400 16.0000	138.112 5.4375	1.5 .06	73.06 kg 161.10 lb							
LM767749DW	406.400 16.0000	138.112 5.4375	1.5 .06	73.14 kg 161.28 lb							
EL768900 Series											
EL768949	433.388 17.0625	27.783 1.0938	.8 .03	4.32 kg 9.54 lb	EL768910	485.775 19.1250	18.258 .7188	3.3 .13	1.96 kg 4.32 lb	27.783 1.0938	
LM769300 Series											
*LM769340DWA	418.000 16.4567	168.275 6.6250	1.5 .06	107.68 kg 237.43 lb	LM769310	571.500 22.5000	66.675 2.6250	6.4 .25	18.20 kg 40.14 lb	161.925 6.3750	LM769340DWA: EXTENDED SMALL RIB
*LM769348ADW	431.800 17.0000	161.925 6.3750	1.5 .06	94.22 kg 207.76 lb							LM769348ADW: HOLES IN OD CENTER
*LM769348DGW	431.800 17.0000	168.275 6.6250	1.5 .06	95.56 kg 210.71 lb							LM769348DGW: ASYMMETRICAL BEARING EXTENDED SMALL RIB GROOVE IN ID
*LM769348DWA	431.800 17.0000	168.275 6.6250	1.5 .06	95.56 kg 210.71 lb							LM769348DWA: ASYMMETRICAL BEARING EXTENDED SMALL RIB
*LM769349ADW	431.800 17.0000	161.925 6.3750	1.5 .06	- -							LM769349ADW: HOLES IN OD CENTER
LM769349D	431.800 17.0000	161.925 6.3750	1.5 .06	- -							
LM769349DW	431.800 17.0000	161.925 6.3750	1.5 .06	- -							LM769349TD: TAPERED BORE
*LM769349TD	431.800 17.0000	161.925 6.3750	1.5 .06	- -							
L770800 Series											
*L770847DGW	457.200 18.0000	133.350 5.2500	1.5 .06	76.93 kg 169.63 lb	L770810	596.900 23.5000	52.388 2.0625	3.3 .13	13.67 kg 30.15 lb	136.525 5.3750	L770847DGW: GROOVE IN ID
L770847DW	457.200 18.0000	133.350 5.2500	1.5 .06	77.01 kg 169.81 lb							L770847DWA: ASYMMETRICAL BEARING EXTENDED SMALL RIB
*L770847DWA	457.200 18.0000	138.112 5.4375	1.5 .06	77.72 kg 171.38 lb							
L770849D	457.200 18.0000	133.350 5.2500	1.5 .06	77.01 kg 169.81 lb							
LM770900 Series											
LM770945	450.850 17.7500	84.138 3.3125	6.4 .25	46.33 kg 102.16 lb	*LM770910-B	603.250 23.7500	60.325 2.3750	3.3 .13	19.16 kg 42.25 lb	39.687 1.5625	LM770910-B: FLANGE ON OD FRONTFACE, BEARING WIDTH IS T1 DIMENSION
LM770949	457.200 18.0000	84.138 3.3125	6.4 .25	43.34 kg 95.58 lb	LM770910	603.250 23.7500	60.325 2.3750	3.3 .13	17.94 kg 39.55 lb	85.725 3.3750	
LL771900 Series											
LL771948	476.250 18.7500	41.275 1.6250	3.3 .13	13.04 kg 28.75 lb	LL771911	565.150 22.2500	31.750 1.2500	3.3 .13	6.24 kg 13.77 lb	41.275 1.6250	LL771911CD: GROOVE IN OD CENTER HOLES IN OD CENTER
					*LL771911CD	565.150 22.2500	76.200 3.0000	1.5 .06	15.28 kg 33.69 lb	95.251 3.7500	
LM772700 Series											
LM772748	488.950 19.2500	84.138 3.3125	6.4 .25	44.45 kg 98.01 lb	LM772710	634.873 24.9950	61.912 2.4375	3.3 .13	19.19 kg 42.30 lb	84.138 3.3125	LM772710CD: GROOVE IN OD CENTER HOLES IN OD CENTER

9

\*\*These Maximum Fillet Radii will be cleared by the Cone or Cup Radii.  
†Bore or O.D. shown are maximum dimensions. \*See Remarks Column.

LM772700 SERIES CONTINUED ON NEXT PAGE

LM772700 – LL783600 SERIES

CONE			Max Shaft Fillet Radii R''	Weight	CUP			Max Hs'ng Fillet Radii r''	Weight	BEARING	Remarks
Number	BORE d	WIDTH B			Number	OUTSIDE DIA D	WIDTH C			WIDTH T	
LM772700 Series (cont)					*LM772710CD	634.873 24.9950	136.525 5.3750	1.5 .06	42.18 kg 93.01 lb	180.975 7.1250	
LM772749D	489.026 19.2530	153.988 6.0625	3.3 .13	101.37 kg 223.52 lb	LM772710	634.873 24.9950	61.912 2.4375	3.3 .13	19.19 kg 42.30 lb	153.988 6.0625	
LM772749DW	489.026 19.2530	153.988 6.0625	3.3 .13	101.19 kg 223.13 lb							
LM774700 Series					†JLM774710	730.000 28.7402	81.496 3.2085	5.0 .20	48.66 kg 107.30 lb	203.000 7.9921	
†JLM774749DW	500.000 19.6850	203.000 7.9921	5.0 .20	230.87 kg 509.08 lb							
776000 Series					776520	1320.800 52.0000	69.850 2.7500	6.4 .25	80.72 kg 177.98 lb	95.250 3.7500	
EE776420	1066.800 42.0000	88.900 3.5000	6.4 .25	- -							
EE776430	1092.200 43.0000	88.900 3.5000	6.4 .25	- -							
LL777100 Series					LL777110	660.400 26.0000	32.545 1.2813	3.3 .13	5.90 kg 13.01 lb	46.037 1.8125	
LL777148	571.500 22.5000	44.450 1.7500	3.3 .13	15.56 kg 34.31 lb							
L778100 Series					L778110	709.612 27.9375	39.688 1.5625	3.3 .13	10.61 kg 23.39 lb	58.737 2.3125	
L778149	584.200 23.0000	57.150 2.2500	3.5 .14	- -							
LM778500 Series					LM778510	762.000 30.0000	77.788 3.0625	6.4 .25	34.63 kg 76.37 lb	107.155 4.2187	LM778510D : GROOVE IN OD CENTER HOLES IN OD CENTER
LM778549	584.200 23.0000	104.775 4.1250	6.4 .25	82.43 kg 181.76 lb	*LM778510D	762.000 30.0000	169.862 6.6875	1.5 .06	75.80 kg 167.15 lb	228.598 8.9999	
LM778549DW	584.200 23.0000	188.912 7.4375	3.3 .13	186.62 kg 411.49 lb	LM778510	762.000 30.0000	77.788 3.0625	6.4 .25	34.63 kg 76.37 lb	193.676 7.6250	
780000 Series					*781376D	349.250 13.7500	98.425 3.8750	1.5 .06	16.89 kg 37.23 lb	139.693 5.4997	780600: NO SMALL RIB
*780600	152.400 6.0000	50.800 2.0000	4.8 .19	- -	781400	355.600 14.0000	41.275 1.6250	4.8 .19	8.03 kg 17.71 lb	61.909 2.4374	780650: NO SMALL RIB
*780650	165.100 6.5000	50.800 2.0000	4.8 .19	- -							780687: NO SMALL RIB
EE780655	165.100 6.5000	60.325 2.3750	4.8 .19	- -							780693: NO SMALL RIB
EE780676	171.450 6.7500	60.325 2.3750	4.8 .19	- -							780700: NO SMALL RIB
*780687	174.625 6.8750	50.800 2.0000	4.8 .19	- -							780702D: NO SMALL RIB
EE780688	174.625 6.8750	60.325 2.3750	4.8 .19	- -							780703W: NO SMALL RIB
*780693	176.212 6.9375	50.800 2.0000	4.8 .19	- -							781376D : GROOVE IN OD CENTER HOLES IN OD CENTER
EE780694	176.212 6.9375	60.325 2.3750	4.8 .19	- -							
*780700	177.800 7.0000	50.800 2.0000	4.8 .19	- -							
*780703W	177.800 7.0000	50.800 2.0000	4.8 .19	- -							
EE780704W	177.800 7.0000	60.325 2.3750	4.8 .19	- -							
EE780705	177.800 7.0000	60.325 2.3750	4.8 .19	- -							
EE780706	177.800 7.0000	60.325 2.3750	12.7 .50	- -							
*780702D	177.800 7.0000	106.362 4.1875	3.3 .13	- -	781400	355.600 14.0000	41.275 1.6250	4.8 .19	8.03 kg 17.71 lb	123.825 4.875	
LL780200 Series					*LL780210-B	725.488 28.5625	33.338 1.3125	3.3 .13	9.53 kg 21.01 lb	20.638 .8125	LL780210-B : FLANGE ON OD FRONTFACE, BEARING WIDTH IS T1 DIMENSION
LL780249	622.300 24.5000	46.038 1.8125	3.5 .14	20.86 kg 45.99 lb							
LL783600 Series					LL783610	901.700 35.5000	46.038 1.8125	6.4 .25	19.75 kg 43.55 lb	66.675 2.6250	
LL783647	758.825 29.8750	65.088 2.5625	6.4 .25	- -							

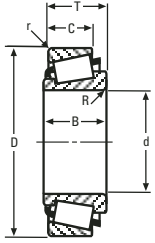

SINGLE ROW



SINGLE ROW WITH FLANGE

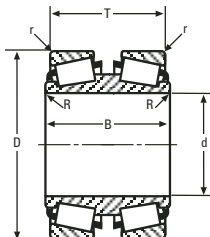

DOUBLE CONE

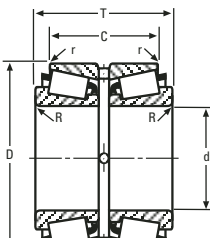

DOUBLE CUP

9

LL783600 – HM803100 SERIES

CONE			Max Shaft Fillet Radii R <sup>..</sup>	Weight	CUP			Max Hs'ng Fillet Radii r <sup>..</sup>	Weight	BEARING WIDTH T	Remarks
Number	BORE d	WIDTH B			Number	OUTSIDE DIA D	WIDTH C				
LL783600 Series (cont)											
LL783649	762.000 30.0000	65.088 2.5625	6.4 .25	- -							
LL787800 Series											
LL787840	939.800 37.0000	101.600 4.0000	9.7 .38	- -	LL787815	1193.800 47.0000	66.675 2.6250	6.4 .25	74.44 kg 164.14 lb	101.600 4.0000	
LL788300 Series											
LL788345	1063.625 41.8750	65.088 2.5625	3.3 .13	- -	LL788310	1219.200 48.0000	42.862 1.6875	3.3 .13	27.68 kg 61.04 lb	65.088 2.5625	
LL788349	1066.800 42.0000	65.088 2.5625	3.3 .13	- -	*LL788310AB	1219.200 48.0000	42.862 1.6875	3.3 .13	30.47 kg 67.18 lb	34.925 1.3750	
					*LL788310-B	1219.200 48.0000	42.862 1.6875	3.3 .13	32.01 kg 70.58 lb	34.925 1.3750	
LL789700 Series											
LL789749	1689.100 66.5000	68.262 2.6875	6.4 .25	- -	LL789710	1844.675 72.6250	42.862 1.6875	6.4 .25	43.04 kg 94.91 lb	68.262 2.6875	
LL789800 Series											
LL789849	1784.350 70.2500	106.362 4.1875	12.7 .50	- -	*LL789810D	2006.600 79.0000	177.800 7.0000	3.3 .13	259.38 kg 571.93 lb	241.300 9.5000	
LL789900 Series											
LL789949	1828.800 72.0000	79.375 3.1250	6.4 .25	- -	LL789910XD	2006.600 79.0000	123.825 4.8750	3.3 .13	170.22 kg 375.33 lb	177.800 7.0000	
790000 Series											
EE790114	292.100 11.5000	136.525 5.3750	6.4 .25	- -	790221	558.800 22.0000	98.425 3.8750	6.4 .25	44.34 kg 97.78 lb	136.525 5.3750	
EE790116	292.100 11.5000	136.525 5.3750	19.8 .78	- -	*790223D	558.800 22.0000	222.250 8.7500	1.5 .06	101.62 kg 224.07 lb	298.450 11.7500	
EE790120	304.800 12.0000	136.525 5.3750	1.3 .05	- -							
EE790119D	304.800 12.0000	285.750 11.2500	3.3 .13	- -	790221	558.800 22.0000	98.425 3.8750	6.4 .25	44.34 kg 97.78 lb	285.750 11.2500	
HM801300 Series											
*HM803145	41.275 1.6250	29.370 1.1563	.8 .03	.59 kg 1.29 lb	HM803110	88.900 3.5000	23.020 .9063	3.3 .13	.31 kg .69 lb	30.162 1.1875	
*HM803146	41.275 1.6250	29.370 1.1563	3.5 .14	.58 kg 1.28 lb	*HM803110RB	88.900 3.5000	23.020 .9063	3.3 .13	.32 kg .70 lb	30.162 1.1875	
*†JHM803148	45.000 1.7717	29.370 1.1563	4.0 .16	.53 kg 1.18 lb	HM803111	88.900 3.5000	23.020 .9063	.8 .03	.32 kg .72 lb	30.162 1.1875	
*HM803149	44.450 1.7500	29.370 1.1563	3.5 .14	.53 kg 1.17 lb	HM803112	92.075 3.6250	23.020 .9063	3.3 .13	.39 kg .87 lb	30.162 1.1875	
					*†JHM803113-B	90.000 3.5433	29.000 1.1417	spcl. spcl.	.48 kg 1.05 lb	9.000 .3543	
M802000 Series											
M802047	41.275 1.6250	25.654 1.0100	.8 .03	- -	M802011	82.550 3.2500	20.193 .7950	3.3 .13	.22 kg .49 lb	26.543 1.0450	
M802048	41.275 1.6250	25.654 1.0100	3.5 .14	- -	M802011AP	82.550 3.2500	20.193 .7950	1.3 .05	.23 kg .51 lb	26.543 1.0450	
M802048AH	41.275 1.6250	25.654 1.0100	3.5 .14	- -							
M802048CP	41.275 1.6250	25.654 1.0100	3.5 .14	- -							
HM803100 Series											
*HM803145	41.275 1.6250	29.370 1.1563	.8 .03	.59 kg 1.29 lb	HM803110	88.900 3.5000	23.020 .9063	3.3 .13	.31 kg .69 lb	30.162 1.1875	
*HM803146	41.275 1.6250	29.370 1.1563	3.5 .14	.58 kg 1.28 lb	*HM803110RB	88.900 3.5000	23.020 .9063	3.3 .13	.32 kg .70 lb	30.162 1.1875	
*†JHM803148	45.000 1.7717	29.370 1.1563	4.0 .16	.53 kg 1.18 lb	HM803111	88.900 3.5000	23.020 .9063	.8 .03	.32 kg .72 lb	30.162 1.1875	
*HM803149	44.450 1.7500	29.370 1.1563	3.5 .14	.53 kg 1.17 lb	HM803112	92.075 3.6250	23.020 .9063	3.3 .13	.39 kg .87 lb	30.162 1.1875	

HM803100 SERIES CONTINUED ON NEXT PAGE

..These Maximum Fillet Radii will be cleared by the Cone or Cup Radii.  
†Bore or O.D. shown are maximum dimensions. \*See Remarks Column.

# HM803100 – HM807000 SERIES

CONE			Max Shaft Fillet Radii R''	Weight	CUP			Max Hs'ng Fillet Radii r''	Weight	BEARING	Remarks
Number	BORE d	WIDTH B			Number	OUTSIDE DIA D	WIDTH C			WIDTH T	
HM803100 Series (cont)					†JHM803113-B	90.000 3.5433	29.000 1.1417	spcl. spcl.	.48 kg 1.05 lb	9.000 .3543	JHM803113-B : FLANGE ON OD FRONTFACE, BEARING WIDTH IS T1 DIMENSION SPECIAL RADIUS ON BACKFACE OD SPECIAL RADIUS ON FRONTFACE OD
M804000 Series					M804010	88.900 3.5000	19.050 .7500	3.3 .13	.22 kg .48 lb	25.400 1.0000	
	†JM804045	45.000 1.7717	25.400 1.0000	1.5 .06	.48 kg 1.07 lb						
	M804048	47.625 1.8750	25.400 1.0000	.8 .03	.45 kg .99 lb						
	M804049	47.625 1.8750	25.400 1.0000	3.5 .14	.44 kg .98 lb						
HM804800 Series											
	HM804840	41.275 1.6250	29.370 1.1563	3.5 .14	.72 kg 1.59 lb	HM804810 95.250 3.7500	23.020 .9063	3.3 .13	.35 kg .76 lb	30.163 1.1875	HM804811-B : FLANGE ON OD FRONTFACE, BEARING WIDTH IS T1 DIMENSION HM804814RB : GROOVE IN OD FRONTFACE
	HM804842	44.450 1.7500	29.370 1.1563	.8 .03	.68 kg 1.49 lb	*HM804811-B 95.250 3.7500	24.021 .9457	3.3 .13	.40 kg .88 lb	11.143 .4387	
	HM804843	44.450 1.7500	29.370 1.1563	3.5 .14	.67 kg 1.48 lb	HM804811 95.250 3.7500	23.020 .9063	.8 .03	.36 kg .79 lb	30.163 1.1875	
	HM804846	47.625 1.8750	29.370 1.1563	3.5 .14	.62 kg 1.36 lb	*HM804814RB 98.425 3.8750	23.020 .9063	3.3 .13	.44 kg .97 lb	30.163 1.1875	
	HM804848	48.412 1.9060	29.370 1.1563	2.3 .09	.61 kg 1.34 lb						
	HM804848A	48.412 1.9060	29.370 1.1563	2.3 .09	.61 kg 1.34 lb						
	HM804849	48.412 1.9060	29.370 1.1563	3.5 .14	.60 kg 1.33 lb						
LM806300 Series											
	*LM806349C	53.975 2.1250	20.244 .7970	2.5 .10	.32 kg .71 lb	LM806310 88.900 3.5000	14.684 .5781	2.0 .08	.14 kg .32 lb	20.241 .7969	LM806349C : FRONTFACE CHAMFER
LM806600 Series											
	LM806649	53.975 2.1250	19.050 .7500	2.3 .09	.29 kg .65 lb	LM806610 88.900 3.5000	13.492 .5312	2.0 .08	.13 kg .29 lb	19.050 .7500	
HM807000 Series											
	HM807035	41.275 1.6250	36.512 1.4375	1.5 .06	1.20 kg 2.66 lb	HM807010 104.775 4.1250	28.575 1.1250	3.3 .13	.50 kg 1.11 lb	36.512 1.4375	HM807046XX : MADE FROM VACUUM MELT STEEL HM807049XX : MADE FROM VACUUM MELT STEEL
	HM807040	44.450 1.7500	36.512 1.4375	3.5 .14	1.14 kg 2.51 lb	*HM807010-B 104.775 4.1250	28.575 1.1250	3.3 .13	.63 kg 1.39 lb	15.875 .6250	HM807010-B : FLANGE ON OD FRONTFACE, BEARING WIDTH IS T1 DIMENSION
	HM807040P	44.450 1.7500	36.512 1.4375	3.5 .14	1.15 kg 2.54 lb	HM807010P 104.775 4.1250	28.575 1.1250	3.3 .13	.50 kg 1.11 lb	36.512 1.4375	
	HM807044	49.212 1.9375	36.512 1.4375	3.5 .14	1.04 kg 2.29 lb	*HM807010XX 104.775 4.1250	28.575 1.1250	3.3 .13	.49 kg 1.08 lb	36.512 1.4375	HM807010XX : MADE FROM VACUUM MELT STEEL
	HM807046	50.800 2.0000	36.512 1.4375	3.5 .14	1.01 kg 2.23 lb	HM807011 104.775 4.1250	28.575 1.1250	.8 .03	.50 kg 1.11 lb	36.512 1.4375	HM807015-B : FLANGE ON OD FRONTFACE, BEARING WIDTH IS T1 DIMENSION
	*HM807046XX	50.800 2.0000	36.512 1.4375	3.5 .14	1.00 kg 2.19 lb	†JHM807012 105.000 4.1339	29.000 1.1417	2.5 .10	.52 kg 1.14 lb	36.873 1.4517	SPECIAL RADIUS ON BACKFACE OD SPECIAL RADIUS ON FRONTFACE OD
	HM807047	50.800 2.0000	38.100 1.5000	3.5 .14	1.02 kg 2.25 lb	*HM807015-B 108.966 4.2900	28.575 1.1250	spcl. spcl.	.71 kg 1.57 lb	14.275 .5620	
	HM807048	54.488 2.1452	36.512 1.4375	3.5 .14	.91 kg 2.01 lb	*HM807015-BA 108.966 4.2900	28.575 1.1250	spcl. spcl.	.72 kg 1.58 lb	14.275 .5620	HM807015-BA : FLANGE ON OD FRONTFACE, BEARING WIDTH IS T1 DIMENSION
	HM807049	53.975 2.1250	36.512 1.4375	3.5 .14	.94 kg 2.07 lb	*HM807015-BR 108.966 4.2900	28.575 1.1250	3.3 .13	.68 kg 1.49 lb	36.512 1.4375	SPECIAL RADIUS ON BACKFACE OD SPECIAL RADIUS ON FRONTFACE OD
	HM807049A	53.975 2.1250	36.512 1.4375	1.5 .06	.93 kg 2.06 lb						
	*HM807049XX	53.975 2.1250	36.512 1.4375	3.5 .14	.92 kg 2.03 lb						
	†JHM807045	50.000 1.9685	36.000 1.4173	3.0 .12	1.02 kg 2.24 lb	JHM807045 may be paired with all single cups corresponding to HM807035 and will require .127 mm (.0050 in) to be added to the T-width values.					

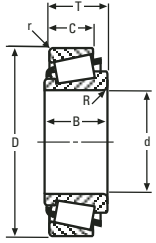

SINGLE ROW



SINGLE ROW WITH FLANGE

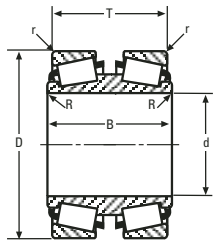

DOUBLE CONE

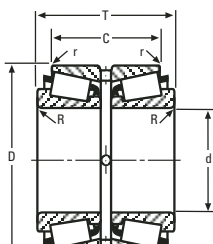

DOUBLE CUP

L812100 – L819300 SERIES

9

CONE			Max Shaft Fillet Radii R''	Weight	CUP			Max Hs'ng Fillet Radii r''	Weight	BEAR-ING	Remarks	
Number	BORE d	WIDTH B			Number	OUTSIDE DIA D	WIDTH C			WIDTH T		
<b>L812100 Series</b>												
L812144	60.325 2.3750	17.247 .6790	2.5 .10	.46 kg 1.01 lb	L812111	103.213 4.0635	11.989 .4720	.8 .03	.13 kg .28 lb	17.247 .6790		
L812147	66.675 2.6250	17.247 .6790	1.5 .06	.37 kg .82 lb								
L812148	66.675 2.6250	17.602 .6930	1.5 .06	.38 kg .84 lb	L812148 may be paired with all single cups corresponding to L812144 and will require .356 mm (.0140 in) to be added to the T-width values.							
<b>LM813000 Series</b>												
†JLM813049	70.000 2.7559	25.000 .9843	1.0 .04	.59 kg 1.30 lb	†JLM813010	110.000 4.3307	20.500 .8071	2.5 .10	.30 kg .65 lb	26.000 1.0236		
<b>HM813800 Series</b>												
HM813836	50.800 2.0000	36.512 1.4375	3.5 .14	1.81 kg 4.00 lb	HM813810	127.000 5.0000	26.988 1.0625	3.3 .13	.62 kg 1.37 lb	36.512 1.4375	HM813815-B : CHAMFER ON FRONTFACE OD FLANGE ON OD FRONTFACE, BEARING WIDTH IS T1 DIMENSION	
HM813839	59.987 2.3617	36.512 1.4375	3.5 .14	1.58 kg 3.49 lb	HM813811	127.000 5.0000	26.988 1.0625	1.5 .06	.62 kg 1.38 lb	36.512 1.4375		
HM813840	55.562 2.1875	36.512 1.4375	3.5 .14	1.70 kg 3.75 lb	*HM813815-B	130.200 5.1260	26.988 1.0625	3.3 .13	.89 kg 1.95 lb	19.865 .7821		
HM813841	60.325 2.3750	36.512 1.4375	3.5 .14	1.58 kg 3.47 lb								
HM813841A	60.325 2.3750	36.512 1.4375	1.5 .06	1.58 kg 3.48 lb								
HM813842	63.500 2.5000	36.512 1.4375	3.5 .14	1.49 kg 3.28 lb								
HM813842A	63.500 2.5000	36.512 1.4375	.8 .03	1.49 kg 3.29 lb								
HM813843	61.912 2.4375	36.512 1.4375	3.5 .14	1.53 kg 3.38 lb								
HM813844	66.675 2.6250	36.512 1.4375	3.5 .14	1.39 kg 3.08 lb								
HM813846	69.850 2.7500	36.512 1.4375	3.5 .14	1.30 kg 2.86 lb								
HM813849	71.438 2.8125	36.512 1.4375	3.5 .14	1.25 kg 2.75 lb								
<b>HH814500 Series</b>												
HH814540	57.150 2.2500	57.150 2.2500	3.5 .14	3.55 kg 7.82 lb	HH814510	152.400 6.0000	41.275 1.6250	3.3 .13	1.74 kg 3.83 lb	53.975 2.1250		HH814510-B : FLANGE ON OD FRONTFACE, BEARING WIDTH IS T1 DIMENSION
HH814547	66.675 2.6250	57.150 2.2500	3.5 .14	3.13 kg 6.90 lb	HH814510A	152.400 6.0000	41.275 1.6250	.8 .03	1.76 kg 3.87 lb	53.975 2.1250		
					*HH814510-B	152.400 6.0000	41.275 1.6250	3.3 .13	1.81 kg 3.99 lb	20.638 .8125		
HH814542	60.325 2.3750	52.705 2.0750	3.5 .14	3.28 kg 7.23 lb	HH814542 may be paired with all single cups corresponding to HH814540 and will require -1.270 mm (-.0500 in) to be added to the T-width values.							
<b>L814700 Series</b>												
L814749	76.200 3.0000	19.050 .7500	1.5 .06	.40 kg .88 lb	L814710	109.538 4.3125	15.083 .5938	1.5 .06	.20 kg .44 lb	19.050 .7500	L814749XX: MADE FROM VACUUM MELT STEEL	
L814749A	76.200 3.0000	19.050 .7500	4.0 .16	.40 kg .87 lb	*L814710D	109.538 4.3125	34.925 1.3750	.8 .03	.47 kg 1.04 lb	42.860 1.6874	L814710D : GROOVE IN OD CENTER HOLES IN OD CENTER	
*L814749XX	76.200 3.0000	19.050 .7500	1.5 .06	.40 kg .88 lb	*L814710DC	109.538 4.3125	34.925 1.3750	.8 .03	.47 kg 1.04 lb	42.860 1.6874	L814710DC : HOLES IN OD CENTER	
					*L814710XX	109.538 4.3125	15.083 .5938	1.5 .06	.20 kg .44 lb	19.050 .7500	L814710XX : MADE FROM VACUUM MELT STEEL	
<b>LM814800 Series</b>												
LM814845	73.025 2.8750	25.400 1.0000	3.5 .14	.72 kg 1.60 lb	LM814810	117.475 4.6250	19.050 .7500	3.3 .13	.29 kg .63 lb	25.400 1.0000	LM814810-B : FLANGE ON OD FRONTFACE, BEARING WIDTH IS T1 DIMENSION	
LM814849	77.788 3.0625	25.400 1.0000	3.5 .14	.61 kg 1.35 lb	*LM814810-B	117.475 4.6250	19.050 .7500	3.3 .13	.34 kg .74 lb	11.112 .4375		
					LM814814	120.650 4.7500	26.195 1.0313	3.3 .13	.49 kg 1.08 lb	27.782 1.0938		
<b>H816200 Series</b>												
H816249	77.788 3.0625	46.248 1.8208	3.5 .14	3.29 kg 7.26 lb	H816210	164.976 6.4951	36.251 1.4272	3.3 .13	1.54 kg 3.40 lb	49.500 1.9488		
<b>L819300 Series</b>												
†JL819349	95.000 3.7402	20.000 .7874	5.0 .20	.58 kg 1.28 lb	†JL819310	135.000 5.3150	14.000 .5512	2.5 .10	.26 kg .58 lb	20.000 .7874		

†These Maximum Fillet Radii will be cleared by the Cone or Cup Radii.  
†Bore or O.D. shown are maximum dimensions. \*See Remarks Column.

820000 – 833000 SERIES

CONE			Max Shaft Fillet Radii R''	Weight	CUP			Max H's'ng Fillet Radii r''	Weight	BEARING WIDTH T	Remarks
Number	BORE d	WIDTH B			Number	OUTSIDE DIA D	WIDTH C				
<b>820000 Series</b>											
EE820085	215.900 8.5000	93.662 3.6875	6.4 .25	-	*820160-B	406.400 16.0000	69.850 2.7500	6.4 .25	18.82 kg 41.50 lb	41.275 1.6250	EE820086: BROKEN FRONTFACE ID HOLES IN FRONTFACE NO SMALL RIB
*EE820086	215.900 8.5000	80.592 3.1729	6.4 .25	34.20 kg 75.40 lb	*820161CD	406.400 16.0000	147.638 5.8125	1.5 .06	35.69 kg 78.70 lb	195.263 7.6875	820160-B : FLANGE ON OD FRONTFACE, BEARING WIDTH IS T1 DIMENSION 820161CD : GROOVE IN OD CENTER HOLES IN OD CENTER
<b>LM820000 Series</b>											
†JL820048	100.000 3.9370	30.000 1.1811	2.3 .09	1.14 kg 2.52 lb	†JLM820012	150.000 5.9055	26.000 1.0236	2.3 .09	.67 kg 1.47 lb	32.000 1.2598	
<b>XR820000 Series</b>											
SEE CROSSED ROLLER BEARING SECTION											
<b>821000 Series</b>											
EE821096D	241.300 9.5000	174.625 6.8750	3.3 .13	-	821165	419.100 16.5000	71.438 2.8125	6.4 .25	16.04 kg 35.36 lb	177.800 7.0000	
<b>HM821500 Series</b>											
HM821547	99.979 3.9362	46.038 1.8125	3.5 .14	8.57 kg 18.89 lb	*HM821511D	196.850 7.7500	74.422 2.9300	1.5 .06	4.31 kg 9.51 lb	103.378 4.0700	HM821511D : GROOVE IN OD CENTER HOLES IN OD CENTER
<b>822000 Series</b>											
EE822100	254.000 10.0000	73.025 2.8750	6.4 .25	-	822175	444.500 17.5000	50.800 2.0000	6.4 .25	13.08 kg 28.84 lb	76.200 3.0000	EE822100X: SHOULDER ON OD FRONTFACE SPECIAL BACKFACE RADIUS SPECIAL FRONTFACE RADIUS
*EE822100X	254.000 10.0000	76.200 3.0000	6.4 .25	-	*822176DC	444.500 17.5000	114.300 4.5000	1.5 .06	30.14 kg 66.45 lb	165.100 6.5000	822176CD : GROOVE IN OD CENTER HOLES IN OD CENTER
					*822176D	444.500 17.5000	114.300 4.5000	1.5 .06	30.14 kg 66.45 lb	165.100 6.5000	822176D : GROOVE IN OD CENTER HOLES IN OD CENTER
					*822176CD	444.500 17.5000	114.300 4.5000	1.5 .06	29.23 kg 64.46 lb	165.100 6.5000	822176D : GROOVE IN OD CENTER HOLES IN OD CENTER
EE822101D	254.000 10.0000	133.350 5.2500	3.3 .13	-	822175	444.500 17.5000	50.800 2.0000	6.4 .25	13.08 kg 28.84 lb	133.350 5.2500	822176DC : HOLES IN OD CENTER
<b>M822000 Series</b>											
†JM822049	110.000 4.3307	35.000 1.3780	3.0 .12	1.63 kg 3.58 lb	†JM822010	165.000 6.4961	26.500 1.0433	2.5 .10	.83 kg 1.84 lb	35.000 1.3780	
†JM822049H	110.000 4.3307	35.000 1.3780	3.0 .12	1.64 kg 3.61 lb							
<b>823000 Series</b>											
EE823103D	260.350 10.2500	196.850 7.7500	6.4 .25	-	823175	444.500 17.5000	73.025 2.8750	3.3 .13	19.50 kg 43.00 lb	196.850 7.7500	
<b>824000 Series</b>											
*NA824102W	260.147 10.2420	66.279 2.6094	1.5 .06	-	*824163XD	412.852 16.2540	91.283 3.5938	3.2 .12	15.77 kg 34.78 lb	132.558 5.2188	NA824102W: SLOTS IN FRONTFACE SPECIAL BACKFACE RADIUS SPECIAL FRONTFACE RADIUS 824163XD : SPECIAL RADIUS ON LEFTFACE OD SPECIAL RADIUS ON RIGHTFACE OD
<b>L826900 Series</b>											
L826949	133.350 5.2500	25.400 1.0000	3.3 .13	1.25 kg 2.75 lb	*L826914-B	184.150 7.2500	18.258 .7188	3.3 .13	.71 kg 1.56 lb	11.905 .4687	L826914-B : FLANGE ON OD FRONTFACE, BEARING WIDTH IS T1 DIMENSION
					L826914	184.150 7.2500	18.258 .7188	3.3 .13	.63 kg 1.38 lb	25.400 1.0000	
<b>HM828400 Series</b>											
*†JHM828449V	140.000 5.5118	55.000 2.1654	3.5 .14	5.23 kg 11.53 lb	*†JHM828410V	220.000 8.6614	42.500 1.6732	3.5 .14	2.34 kg 5.17 lb	55.000 2.1654	JHM828449V: MADE FROM VACUUM MELT STEEL JHM828410V : MADE FROM VACUUM MELT STEEL
<b>LL829600 Series</b>											
LL829648NA	147.587 5.8105	18.131 .7138	2.3 .09	-	*LL829611D	180.924 7.1230	26.988 1.0625	.8 .03	.56 kg 1.24 lb	36.261 1.4276	LL829611D : GROOVE IN OD CENTER HOLES IN OD CENTER
<b>833000 Series</b>											
*EE833157DW	400.050 15.7500	193.675 7.6250	3.3 .13	-	833232	590.550 23.2500	80.962 3.1875	6.4 .25	26.66 kg 58.78 lb	193.674 7.6250	EE833157DW: KEYWAY IN ID 833233D : GROOVE IN OD CENTER HOLES IN OD CENTER
EE833161XD	406.400 16.0000	193.675 7.6250	3.3 .13	-							

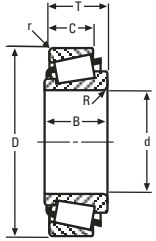

SINGLE ROW

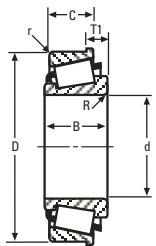

SINGLE ROW WITH FLANGE

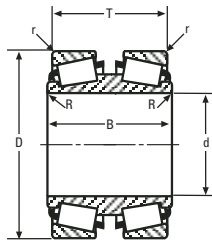

DOUBLE CONE

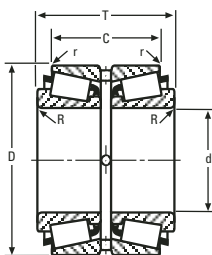

DOUBLE CUP

833000 SERIES CONTINUED ON NEXT PAGE

\*These Maximum Fillet Radii will be cleared by the Cone or Cup Radii.  
†Bore or O.D. shown are maximum dimensions. \*See Remarks Column.



CONE			Max Shaft Fillet Radii R''	Weight	CUP			Max Hs'ng Fillet Radii r''	Weight	BEARING	Remarks
Number	BORE d	WIDTH B			Number	OUTSIDE DIA D	WIDTH C			WIDTH T	
833000 Series (cont)											
EE833160X	406.400 16.0000	107.950 4.2500	9.7 .38	-	833232	590.550 23.2500	80.962 3.1875	6.4 .25	26.66 kg 58.78 lb	107.950 4.2500	
					*833233D	590.550 23.2500	174.625 6.8750	1.5 .06	59.72 kg 131.68 lb	228.600 9.0000	
XR836000 Series											
SEE CROSSED ROLLER BEARING SECTION											
HH840200 Series											
HH840249	190.500 7.5000	95.250 3.7500	6.4 .25	23.66 kg 52.18 lb	HH840210	336.550 13.2500	73.025 2.8750	6.4 .25	12.96 kg 28.58 lb	98.425 3.8750	
HM840400 Series											
†JHM840449	200.000 7.8740	62.000 2.4409	3.5 .14	10.39 kg 22.91 lb	†JHM840410	300.000 11.8110	51.000 2.0079	2.5 .10	5.15 kg 11.35 lb	65.000 2.5591	
†JHM840449A	200.000 7.8740	62.000 2.4409	9.7 .38	10.44 kg 23.02 lb							
843000 Series											
EE843220	558.800 22.0000	88.108 3.4688	6.4 .25	-	843290	736.600 29.0000	63.500 2.5000	6.4 .25	24.25 kg 53.47 lb	88.106 3.4687	EE843220DW: HOLES IN OD CENTER SHOULDER ON ID RIGHTSIDE SLOTS IN LEFTFACE
EE843220AX	558.800 22.0000	88.108 3.4688	9.7 .38	-	*843291D	736.600 29.0000	138.112 5.4375	1.5 .06	56.87 kg 125.40 lb	187.325 7.3750	EE843221D: SHOULDER ON ID RIGHTSIDE
					*843291CD	736.600 29.0000	138.112 5.4375	1.5 .06	52.61 kg 116.00 lb	187.325 7.3750	843291CD : GROOVE IN OD CENTER HOLES IN OD CENTER
					*843292D	742.950 29.2500	138.112 5.4375	1.5 .06	61.12 kg 134.78 lb	187.325 7.3750	843291D : GROOVE IN OD CENTER HOLES IN OD CENTER
*EE843220DW	558.800 22.0000	155.575 6.1250	3.3 .13	-	843290	736.600 29.0000	63.500 2.5000	6.4 .25	24.25 kg 53.47 lb	155.578 6.1251	843292D : GROOVE IN OD CENTER HOLES IN OD CENTER
*EE843221D	558.800 22.0000	155.575 6.1250	3.3 .13	-							
LM844000 Series											
LM844049	223.838 8.8125	46.038 1.8125	3.5 .14	5.57 kg 12.29 lb	LM844010	295.275 11.6250	34.925 1.3750	3.3 .13	2.56 kg 5.64 lb	46.038 1.8125	LM844010DC :HOLES IN OD CENTER
					*LM844010DC	295.275 11.6250	77.788 3.0625	.8 .03	6.26 kg 13.80 lb	100.013 3.9375	
XR844000 Series											
SEE CROSSED ROLLER BEARING SECTION											
L848800 Series											
*L848848XX	253.975 9.9990	41.500 1.6339	1.5 .06	5.37 kg 11.85 lb	L848810	324.950 12.7933	27.998 1.1023	3.3 .13	2.14 kg 4.72 lb	39.000 1.5354	L848848XX: MADE FROM VACUUM MELT STEEL
L848849	253.975 9.9990	41.500 1.6339	1.5 .06	5.37 kg 11.85 lb	L848811	324.950 12.7933	27.998 1.1023	3.3 .13	2.07 kg 4.57 lb	39.000 1.5354	L848812XX : MADE FROM VACUUM MELT STEEL
					*L848812XX	324.950 12.7933	27.998 1.1023	3.3 .13	2.07 kg 4.57 lb	39.000 1.5354	JL848815-B : FLANGE ON OD FRONTFACE, BEARING WIDTH IS T1 DIMENSION
					*†JL848815-B	330.000 12.9921	27.998 1.1023	3.3 .13	3.00 kg 6.62 lb	17.000 .6693	
H852800 Series											
H852849	266.700 10.5000	117.475 4.6250	6.4 .25	47.48 kg 104.69 lb	H852810	444.500 17.5000	88.900 3.5000	6.4 .25	25.28 kg 55.75 lb	120.650 4.7500	
L853000 Series											
L853042	264.975 10.4321	34.925 1.3750	3.5 .14	6.79 kg 14.97 lb	L853010	352.425 13.8750	23.812 .9375	3.3 .13	2.25 kg 4.97 lb	36.513 1.4375	L853011-B : FLANGE ON OD FRONTFACE, BEARING WIDTH IS T1 DIMENSION
L853048	275.000 10.8268	40.000 1.5748	3.5 .14	6.08 kg 13.41 lb	*L853011-B	349.949 13.7775	23.812 .9375	3.3 .13	2.17 kg 4.78 lb	18.700 .7362	
L853049	276.225 10.8750	34.925 1.3750	3.5 .14	5.48 kg 12.09 lb							
XR855000 Series											
SEE CROSSED ROLLER BEARING SECTION											
HM855400 Series											
HM855449	276.225 10.8750	85.725 3.3750	6.4 .25	-	*HM855419D	508.000 20.0000	127.000 5.0000	3.3 .13	69.61 kg 153.49 lb	190.500 7.5000	HM855419D : GROOVE IN OD CENTER HOLES IN OD CENTER
HM858500 Series											
HM858548D	305.054 12.0100	200.000 7.8740	3.3 .13	-	HM858511	499.948 19.6830	77.788 3.0625	6.4 .25	23.59 kg 52.02 lb	200.000 7.8740	

†These Maximum Fillet Radii will be cleared by the Cone or Cup Radii.  
†Bore or O.D. shown are maximum dimensions. \*See Remarks Column.

9

**H859000 – LM869400 SERIES**

CONE			Max Shaft Fillet Radii R <sup>**</sup>	Weight	CUP			Max H's'ng Fillet Radii r <sup>**</sup>	Weight	BEARING WIDTH T	Remarks
Number	BORE d	WIDTH B			Number	OUTSIDE DIA D	WIDTH C				
<b>H859000 Series</b>											
H859049	314.325 12.3750	119.062 4.6875	6.4 .25	54.29 kg 119.71 lb	H859010	495.300 19.5000	88.900 3.5000	6.4 .25	28.46 kg 62.75 lb	120.650 4.7500	H859049H: GROOVE IN OD FRONTFACE NO SMALL RIB SHOULDER ON OD FRONTFACE
*H859049H	314.325 12.3750	119.062 4.6875	6.4 .25	56.12 kg 123.75 lb	H859010V	495.300 19.5000	88.900 3.5000	6.4 .25	28.46 kg 62.75 lb	120.650 4.7500	
H859049V	314.325 12.3750	119.062 4.6875	6.4 .25	54.26 kg 119.64 lb							
<b>L860000 Series</b>											
L860048	330.200 13.0000	47.625 1.8750	12.7 .50	9.06 kg 19.99 lb	L860010	415.925 16.3750	34.925 1.3750	3.3 .13	4.47 kg 9.86 lb	47.625 1.8750	L860010CD : GROOVE IN OD CENTER HOLES IN OD CENTER
L860049	330.200 13.0000	47.625 1.8750	3.5 .14	9.68 kg 21.35 lb	*L860010CD	415.925 16.3750	74.612 2.9375	1.5 .06	9.35 kg 20.62 lb	100.012 3.9375	
L860049A	329.895 12.9880	47.625 1.8750	3.5 .14	9.76 kg 21.53 lb							
L860049AA	333.000 13.1102	47.625 1.8750	3.5 .14	9.20 kg 20.30 lb							
<b>L862600 Series</b>											
*L862649D GW	343.052 13.5060	127.000 5.0000	1.5 .06	41.65 kg 91.83 lb	*L862610	457.098 17.9960	36.551 1.4390	.5 .02	4.30 kg 9.47 lb	97.653 3.8446	L862649D GW: ASYMMETRICAL BEARING GROOVE IN ID SHOULDER ON ID RIGHTSIDE SLOTS IN LEFTFACE
					*L862611	457.098 17.9960	61.397 2.4172	3.3 .13	6.73 kg 14.83 lb	147.345 5.8010	
<b>L865500 Series</b>											
L865547	381.000 15.0000	47.625 1.8750	6.4 .25	12.64 kg 27.87 lb	*L865512-B	479.425 18.8750	34.925 1.3750	3.3 .13	6.05 kg 13.35 lb	23.813 .9375	L865512-B : CHAMFER ON FRONTFACE OD FLANGE ON OD FRONTFACE, BEARING WIDTH IS T1 DIMENSION
L865548	381.000 15.0000	47.625 1.8750	12.7 .50	12.06 kg 26.59 lb	L865512	479.425 18.8750	34.925 1.3750	3.3 .13	5.60 kg 12.34 lb	49.213 1.9375	
<b>LM867900 Series</b>											
*LM867949ADW	406.400 16.0000	144.462 5.6875	.8 .03	66.24 kg 146.07 lb	*LM867910	546.100 21.5000	42.819 1.6858	1.3 .05	8.36 kg 18.43 lb	116.144 4.5726	LM867949ADW: ASYMMETRICAL BEARING GROOVE IN ID HOLES IN OD CENTER SHOULDER ON ID RIGHTSIDE SLOTS IN LEFTFACE
*LM867949D GW	406.400 16.0000	144.462 5.6875	.8 .03	66.40 kg 146.41 lb	*LM867911	546.100 21.5000	67.236 2.6471	6.4 .25	15.23 kg 33.58 lb	166.807 6.5672	
<b>LM869400 Series</b>											
LM869448	431.800 17.0000	74.612 2.9375	3.3 .13	32.61 kg 71.91 lb	LM869410	571.500 22.5000	52.388 2.0625	3.3 .13	14.74 kg 32.50 lb	74.612 2.9375	LM869448D: ASYMMETRICAL BEARING HOLES IN OD CENTER SHOULDER ON OD RIGHTFACE
LM869448A	431.800 17.0000	74.612 2.9375	6.4 .25	32.52 kg 71.70 lb	*LM869410CD	571.500 22.5000	111.125 4.3750	1.5 .06	30.85 kg 68.03 lb	155.575 6.1250	
LM869448AA	431.800 17.0000	74.612 2.9375	9.7 .38	32.23 kg 71.07 lb							LM869449ADG: ASYMMETRICAL BEARING GROOVE IN ID HOLES IN OD CENTER SHOULDER ON OD RIGHTFACE SLOTS IN LEFTFACE
*LM869448D	431.800 17.0000	133.350 5.2500	1.5 .06	73.90 kg 162.96 lb	LM869410	571.500 22.5000	52.388 2.0625	3.3 .13	14.74 kg 32.50 lb	136.525 5.3750	
*LM869449ADG	431.800 17.0000	133.350 5.2500	1.5 .06	73.65 kg 162.40 lb							LM869449ADW: ASYMMETRICAL BEARING GROOVE IN ID SHOULDER ON OD RIGHTFACE SLOTS IN LEFTFACE
*LM869449ADW	431.800 17.0000	133.350 5.2500	1.5 .06	73.79 kg 162.71 lb							
*LM869449D GW	431.800 17.0000	133.350 5.2500	1.5 .06	73.57 kg 162.23 lb							LM869449D GW: ASYMMETRICAL BEARING GROOVE IN ID SHOULDER ON OD RIGHTFACE SLOTS IN LEFTFACE
*LM869449DW	431.800 17.0000	133.350 5.2500	1.5 .06	73.81 kg 162.75 lb							

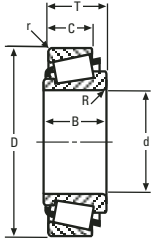

**SINGLE ROW**



**SINGLE ROW WITH FLANGE**

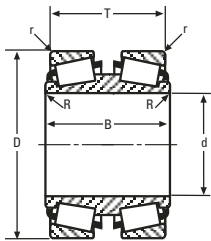

**DOUBLE CONE**

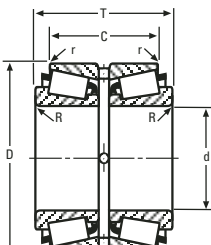

**DOUBLE CUP**

**9**

LM869400 SERIES CONTINUED ON NEXT PAGE

\*\*These Maximum Fillet Radii will be cleared by the Cone or Cup Radii.  
†Bore or O.D. shown are maximum dimensions. \*See Remarks Column.

LM869400 – HM903200 SERIES

9

CONE				Max Shaft Fillet Radii R''	Weight	CUP			Max Hs'ng Fillet Radii r''	Weight	BEAR-ING	Remarks
Number	BORE d	WIDTH B	Number			OUTSIDE DIA D	WIDTH C	WIDTH T				
LM869400 Series (cont)												
LM869410CD : GROOVE IN OD CENTER HOLES IN OD CENTER												
L871300 Series												
*L871349DGW	457.200 18.0000	138.112 5.4375	.8 .03	72.66 kg 160.21 lb	*L871310 596.900 23.5000	40.780 1.6055	.5 .02	8.15 kg 17.96 lb	109.459 4.3094	L871349DGW: ASYMMETRICAL BEARING GROOVE IN ID SHOULDER ON ID RIGHTSIDE SLOTS IN LEFTFACE		
					*L871311 596.900 23.5000	67.274 2.6486	3.3 .13	15.92 kg 35.10 lb	162.448 6.3956	L871310 : SHOULDER ON OD BACKFACE  L871311 : GROOVE IN OD CENTER SHOULDER ON ID BACKFACE		
EL875800 Series												
EL875849	549.275 21.6250	26.988 1.0625	.8 .03	5.73 kg 12.63 lb	EL875810	603.250 23.7500	18.258 .7188	3.3 .13	2.54 kg 5.59 lb	27.782 1.0938		
LL876400 Series												
LL876449	558.800 22.0000	48.412 1.9060	6.4 .25	19.16 kg 42.25 lb	LL876410	660.400 26.0000	34.925 1.3750	3.3 .13	7.80 kg 17.19 lb	50.000 1.9685	LL876412X : HOLES IN FRONTFACE SHOULDER ON OD BACKFACE	
					*LL876412X	692.000 27.2441	34.925 1.3750	- -	14.38 kg 31.71 lb	50.000 1.9685		
LL876449D	558.800 22.0000	92.075 3.6250	1.5 .06	44.25 kg 97.57 lb	LL876410	660.400 26.0000	34.925 1.3750	3.3 .13	7.80 kg 17.19 lb	95.250 3.7500		
					*LL876412X	692.000 27.2441	34.925 1.3750	- -	14.38 kg 31.71 lb	95.250 3.7500		
L879900 Series												
L879946	609.397 23.9920	92.075 3.6250	6.4 .25	64.41 kg 142.03 lb	L879910	762.000 30.0000	71.438 2.8125	6.4 .25	28.50 kg 62.83 lb	95.250 3.7500		
L879947	609.600 24.0000	92.075 3.6250	6.4 .25	64.27 kg 141.72 lb								
LM881200 Series												
*LM881245D	635.000 25.0000	304.800 12.0000	3.3 .13	- -	LM881214	939.800 37.0000	119.062 4.6875	6.4 .25	113.95 kg 251.25 lb	304.800 12.0000	LM881245D: EXTENDED SMALL RIB	
XR882000 Series												
SEE CROSSED ROLLER BEARING SECTION												
L882400 Series												
L882449	709.976 27.9518	110.000 4.3307	6.4 .25	- -	L882410	899.924 35.4301	78.000 3.0709	6.4 .25	44.90 kg 99.01 lb	110.000 4.3307	L882449DGW: GROOVE IN ID	
					*L882410D	899.924 35.4301	166.002 6.5355	3.3 .13	96.54 kg 212.88 lb	230.000 9.0551	L882410CD : GROOVE IN OD CENTER HOLES IN OD CENTER	
					*L882410CD	899.924 35.4301	166.002 6.5355	3.3 .13	96.40 kg 212.56 lb	230.000 9.0551	L882410D : GROOVE IN OD CENTER HOLES IN OD CENTER	
*L882449DGW	709.925 27.9498	200.000 7.8740	3.3 .13	- -	L882410	899.924 35.4301	78.000 3.0709	6.4 .25	44.90 kg 99.01 lb	200.000 7.8740		
L882449DW	709.925 27.9498	200.000 7.8740	3.3 .13	- -								
LL889000 Series												
LL889049	1270.000 50.0000	65.088 2.5625	6.4 .25	- -	*LL889010-B	1435.100 56.5000	47.625 1.8750	6.4 .25	44.78 kg 98.75 lb	36.512 1.4375	LL889010-B : FLANGE ON OD FRONTFACE, BEARING WIDTH IS T1 DIMENSION	
					LL889010	1435.100 56.5000	47.625 1.8750	6.4 .25	40.68 kg 89.70 lb	69.850 2.7500	LL889010D : GROOVE IN OD CENTER HOLES IN OD CENTER	
					*LL889010D	1435.100 56.5000	101.600 4.0000	3.3 .13	89.90 kg 198.24 lb	146.050 5.7500		
XR889000 Series												
SEE CROSSED ROLLER BEARING SECTION												
XR897000 Series												
SEE CROSSED ROLLER BEARING SECTION												
HM903200 Series												
HM903241	38.100 1.5000	28.575 1.1250	3.5 .14	.72 kg 1.59 lb	HM903210	95.250 3.7500	22.225 .8750	.8 .03	.38 kg .85 lb	30.958 1.2188		
HM903244	41.275 1.6250	28.300 1.1142	1.5 .06	.68 kg 1.49 lb	HM903216	98.425 3.8750	22.225 .8750	.8 .03	.47 kg 1.03 lb	30.958 1.2188		
HM903245	41.275 1.6250	28.575 1.1250	3.5 .14	.68 kg 1.49 lb								
HM903247	44.450 1.7500	28.300 1.1142	1.3 .05	.63 kg 1.39 lb								

\*These Maximum Fillet Radii will be cleared by the Cone or Cup Radii.  
†Bore or O.D. shown are maximum dimensions. \*See Remarks Column.

HM903200 – H913800 SERIES

CONE			Max Shaft Fillet Radii R''	Weight	CUP			Max Hs'ng Fillet Radii r''	Weight	BEARING	Remarks
Number	BORE d	WIDTH B			Number	OUTSIDE DIA D	WIDTH C			WIDTH T	
<b>HM903200 Series (cont)</b>											
HM903248	44.988 1.7712	28.575 1.1250	3.5 .14	.62 kg 1.37 lb							
HM903249	44.450 1.7500	28.575 1.1250	3.5 .14	.63 kg 1.39 lb							
HM903249A	44.450 1.7500	28.300 1.1142	3.5 .14	.63 kg 1.38 lb							
<b>M903300 Series</b>											
*M903345	41.275 1.6250	23.812 .9375	3.5 .14	.55 kg 1.21 lb	*M903310	92.075 3.6250	16.670 .6563	1.5 .06	.24 kg .53 lb	26.195 1.0313	M903345: SPECIAL BACKFACE RADIUS M903310: SPECIAL RADIUS ON BACKFACE OD SPECIAL RADIUS ON FRONTFACE OD
<b>HM905800 Series</b>											
HM905843	44.988 1.7712	31.750 1.2500	2.5 .10	.89 kg 1.96 lb	HM905810	104.986 4.1333	23.368 .9200	2.5 .10	.49 kg 1.08 lb	32.512 1.2800	
<b>HM907600 Series</b>											
HM907635	44.450 1.7500	28.575 1.1250	.8 .03	.97 kg 2.14 lb	HM907614	111.125 4.3750	20.638 .8125	3.3 .13	.50 kg 1.10 lb	30.163 1.1875	
HM907639	47.625 1.8750	28.575 1.1250	3.5 .14	.91 kg 2.01 lb	HM907616	112.712 4.4375	20.638 .8125	3.3 .13	.56 kg 1.23 lb	30.163 1.1875	
HM907643	50.800 2.0000	28.575 1.1250	3.5 .14	.86 kg 1.89 lb							
<b>910000 Series</b>											
EE911576D	400.050 15.7500	142.875 5.6250	3.5 .14	- -	912400	609.600 24.0000	60.325 2.3750	6.4 .25	23.82 kg 52.52 lb	157.163 6.1875	912401D: GROOVE IN OD CENTER HOLES IN OD CENTER
EE911603D	406.400 16.0000	149.225 5.8750	3.5 .14	- -							
EE911600	406.400 16.0000	84.138 3.3125	6.8 .27	- -	912400	609.600 24.0000	60.325 2.3750	6.4 .25	23.82 kg 52.52 lb	92.075 3.6250	
EE911618	411.162 16.1875	84.138 3.3125	6.8 .27	- -	*912401D	609.600 24.0000	123.825 4.8750	1.5 .06	49.65 kg 109.48 lb	187.325 7.3750	
<b>L910300 Series</b>											
L910349	63.487 2.4995	15.500 .6102	1.0 .04	- -	L910310	94.976 3.7392	12.000 .4724	1.0 .04	.14 kg .30 lb	17.000 .6693	
<b>HM911200 Series</b>											
HM911242	53.975 2.1250	33.338 1.3125	3.5 .14	1.55 kg 3.41 lb	*HM911210-B	130.175 5.1250	23.812 .9375	3.3 .13	.77 kg 1.69 lb	19.050 .7500	HM911210-B: FLANGE ON OD FRONTFACE, BEARING WIDTH IS T1 DIMENSION
HM911245	60.325 2.3750	33.338 1.3125	5.0 .20	1.39 kg 3.06 lb	HM911210	130.175 5.1250	23.812 .9375	3.3 .13	.67 kg 1.48 lb	36.513 1.4375	
HM911249	61.912 2.4375	33.338 1.3125	3.5 .14	1.36 kg 3.00 lb	†JHM911211	130.000 5.1181	22.649 .8917	3.3 .13	.65 kg 1.44 lb	36.512 1.4375	
					HM911216	134.983 5.3143	21.948 .8641	3.5 .14	.80 kg 1.76 lb	35.862 1.4119	
HM911243	53.975 2.1250	30.924 1.2175	3.5 .14	1.45 kg 3.20 lb	HM911243 and grouped cones may be paired with all single cups corresponding to HM911242 and will require -.2413 mm (-.0950 in) to be added to the T-width values.						
HM911244	59.987 2.3617	30.924 1.2175	3.5 .14	1.32 kg 2.91 lb							
<b>M913700 Series</b>											
†JM913740	50.000 1.9685	31.000 1.2205	2.5 .10	3.36 kg 7.41 lb	*†JM913715D	140.000 5.5118	42.000 1.6535	.8 .03	1.73 kg 3.82 lb	70.000 2.7559	JM913715D: GROOVE IN OD CENTER HOLES IN OD CENTER
<b>H913800 Series</b>											
H913840	59.987 2.3617	39.688 1.5625	3.5 .14	2.29 kg 5.05 lb	H913810	146.050 5.7500	25.400 1.0000	3.3 .13	.88 kg 1.95 lb	41.275 1.6250	
H913842	61.912 2.4375	39.688 1.5625	3.5 .14	2.23 kg 4.92 lb	†JH913811	150.000 5.9055	25.400 1.0000	3.3 .13	1.07 kg 2.35 lb	41.275 1.6250	
H913843	61.912 2.4375	39.688 1.5625	7.0 .28	2.20 kg 4.85 lb							
†JH913848	70.000 2.7559	39.688 1.5625	2.0 .08	1.98 kg 4.36 lb							
H913849	69.850 2.7500	39.688 1.5625	3.5 .14	1.97 kg 4.35 lb							

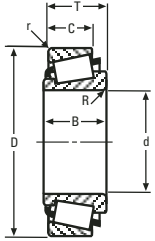

SINGLE ROW

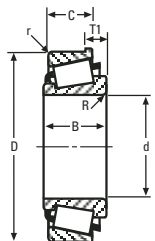

SINGLE ROW WITH FLANGE

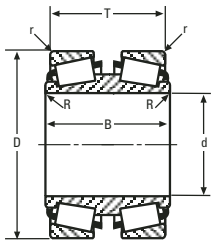

DOUBLE CONE

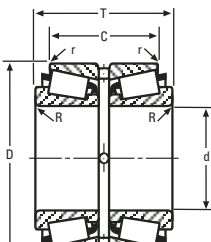

DOUBLE CUP

EL914000 – LM921800 SERIES

CONE			Max Shaft Fillet Radii R <sup>†</sup>	Weight	CUP			Max Hs'ng Fillet Radii r <sup>†</sup>	Weight	BEARING	Remarks
Number	BORE d	WIDTH B			Number	OUTSIDE DIA D	WIDTH C			WIDTH T	
<b>EL914000 Series</b>											
*EL914049	76.200 3.0000	9.525 .3750	1.3 .05	.14 kg .31 lb	*EL914010	98.425 3.8750	7.145 .2813	1.3 .05	.07 kg .16 lb	11.112 .4375	EL914049: SPECIAL BACKFACE RADIUS SPECIAL FRONTFACE RADIUS  EL914010: SPECIAL RADIUS ON BACKFACE OD SPECIAL RADIUS ON FRONTFACE OD
<b>HH914400 Series</b>											
HH914447	63.500 2.5000	53.975 2.1250	3.5 .14	4.37 kg 9.63 lb	HH914412	177.800 7.0000	37.308 1.4688	3.3 .13	2.51 kg 5.53 lb	57.150 2.2500	
HH914449	66.675 2.6250	53.975 2.1250	3.5 .14	4.23 kg 9.32 lb							
<b>HM914500 Series</b>											
HM914545	69.850 2.7500	33.338 1.3125	4.0 .16	1.67 kg 3.68 lb	HM914510	146.050 5.7500	23.812 .9375	3.3 .13	.89 kg 1.96 lb	36.512 1.4375	
<b>H914800 Series</b>											
H914841	68.262 2.6875	46.038 1.8125	3.5 .14	2.89 kg 6.36 lb	H914811	152.400 6.0000	35.100 1.3819	3.3 .13	1.53 kg 3.36 lb	47.626 1.8750	
<b>H916600 Series</b>											
H916642	69.987 2.7554	53.183 2.0938	3.3 .13	4.17 kg 9.19 lb	H916610	176.212 6.9375	36.512 1.4375	3.3 .13	2.22 kg 4.90 lb	54.770 2.1563	
<b>H917800 Series</b>											
H917840	76.200 3.0000	53.183 2.0938	3.5 .14	4.39 kg 9.69 lb	H917810	180.975 7.1250	35.720 1.4063	3.3 .13	2.16 kg 4.76 lb	53.975 2.1250	
H917849	82.550 3.2500	53.183 2.0938	3.3 .13	4.06 kg 8.96 lb							
<b>M919000 Series</b>											
M919048	89.980 3.5425	30.162 1.1875	3.5 .14	3.61 kg 7.97 lb	*M919010D	161.900 6.3740	44.450 1.7500	1.5 .06	1.80 kg 3.98 lb	69.850 2.7500	M919010D: GROOVE IN OD CENTER HOLES IN OD CENTER
M919049	89.980 3.5425	30.162 1.1875	2.0 .08	3.63 kg 8.01 lb							
<b>H919900 Series</b>											
H919942	84.138 3.3125	49.000 1.9291	6.4 .25	4.66 kg 10.27 lb	H919911	193.675 7.6250	34.498 1.3582	6.4 .25	2.34 kg 5.17 lb	52.000 2.0472	
H919942H	84.138 3.3125	49.000 1.9291	6.4 .25	4.66 kg 10.27 lb							
<b>920000 Series</b>											
EE921124	285.750 11.2500	80.569 3.1720	9.7 .38	- -	921850	469.900 18.5000	57.150 2.2500	3.3 .13	12.77 kg 28.16 lb	81.770 3.2193	921851D: GROOVE IN OD CENTER HOLES IN OD CENTER
					*921851D	469.900 18.5000	127.000 5.0000	1.5 .06	29.58 kg 65.23 lb	177.785 6.9994	921876D: GROOVE IN OD CENTER HOLES IN OD CENTER
					921875	476.250 18.7500	57.150 2.2500	3.3 .13	14.88 kg 32.81 lb	81.770 3.2193	
					*921876D	476.250 18.7500	127.000 5.0000	1.5 .06	33.04 kg 72.85 lb	177.785 6.9994	
EE921150D	292.100 11.5000	142.875 5.6250	1.5 .06	- -	921850	469.900 18.5000	57.150 2.2500	3.3 .13	12.77 kg 28.16 lb	138.928 5.4696	
					921875	476.250 18.7500	57.150 2.2500	3.3 .13	14.88 kg 32.81 lb	138.928 5.4696	
<b>HM921300 Series</b>											
HM921343	89.916 3.5400	36.512 1.4375	3.5 .14	7.13 kg 15.72 lb	*HM921310D	189.967 7.4790	54.102 2.1300	1.5 .06	3.17 kg 6.98 lb	85.852 3.3800	HM921343V: MADE FROM VACUUM MELT STEEL HM921310D: GROOVE IN OD CENTER HOLES IN OD CENTER
*HM921343V	89.916 3.5400	36.512 1.4375	3.5 .14	7.13 kg 15.72 lb	*HM921310DV	189.967 7.4790	54.102 2.1300	1.5 .06	3.17 kg 6.98 lb	85.852 3.3800	HM921310DV: GROOVE IN OD CENTER HOLES IN OD CENTER MADE FROM VACUUM MELT STEEL
HM921348	98.425 3.8750	36.512 1.4375	3.5 .14	6.41 kg 14.13 lb							
<b>LM921800 Series</b>											
LM921845	101.600 4.0000	31.750 1.2500	3.3 .13	2.21 kg 4.88 lb	LM921810	177.800 7.0000	19.050 .7500	3.3 .13	.86 kg 1.90 lb	34.925 1.3750	

9

<sup>†</sup>These Maximum Fillet Radii will be cleared by the Cone or Cup Radii.  
†Bore or O.D. shown are maximum dimensions. \*See Remarks Column.

923000 – 931000 SERIES

CONE			Max Shaft Fillet Radii R <sup>**</sup>	Weight	CUP			Max Hs'ng Fillet Radii r <sup>**</sup>	Weight	BEARING	Remarks
Number	BORE d	WIDTH B			Number	OUTSIDE DIA D	WIDTH C			WIDTH T	
<b>923000 Series</b>											
EE923095	241.300 9.5000	100.012 3.9375	6.4 .25	- -	923175 *923176D	444.500 17.5000 444.500 17.5000	76.200 3.0000 158.750 6.2500	4.8 .19 1.5 .06	21.20 kg 46.75 lb 41.54 kg 91.59 lb	101.600 4.0000 209.550 8.2500	923176D : GROOVE IN OD CENTER HOLES IN OD CENTER
<b>HH923600 Series</b>											
HH923649	101.600 4.0000	73.025 2.8750	6.4 .25	11.13 kg 24.54 lb	HH923610 HH923611	250.825 9.8750 250.825 9.8750	50.800 2.0000 50.800 2.0000	6.4 .25 3.3 .13	6.35 kg 14.00 lb 6.44 kg 14.19 lb	76.200 3.0000 76.200 3.0000	
<b>H924000 Series</b>											
H924033	101.600 4.0000	52.388 2.0625	3.5 .14	6.28 kg 13.85 lb	H924010	214.312 8.4375	39.688 1.5625	3.3 .13	2.79 kg 6.15 lb	55.562 2.1875	H924010D : GROOVE IN OD CENTER HOLES IN OD CENTER
H924043	109.984 4.3301	52.388 2.0625	3.5 .14	5.71 kg 12.58 lb	*H924010D	214.312 8.4375	84.138 3.3125	1.5 .06	6.52 kg 14.38 lb	115.887 4.5625	
H924045	111.125 4.3750	52.388 2.0625	3.5 .14	5.63 kg 12.41 lb							
<b>HH924300 Series</b>											
HH924349	111.125 4.3750	71.438 2.8125	6.4 .25	19.84 kg 43.74 lb	*HH924310D *HH924310DC	241.300 9.5000 241.300 9.5000	107.950 4.2500 107.950 4.2500	1.5 .06 1.5 .06	11.10 kg 24.48 lb 11.10 kg 24.48 lb	158.750 6.2500 158.750 6.2500	HH924310D : GROOVE IN OD CENTER HOLES IN OD CENTER HH924310DC : HOLES IN OD CENTER
<b>925000 Series</b>											
*EE925179D	457.073 17.9950	412.750 16.2500	3.3 .13	- -	925295	749.300 29.5000	184.150 7.2500	6.4 .25	129.69 kg 285.97 lb	419.100 16.5000	EE925179D : HOLES IN OD CENTER
<b>HH926700 Series</b>											
HH926744	114.300 4.5000	82.550 3.2500	6.4 .25	15.80 kg 34.83 lb	HH926710	273.050 10.7500	53.975 2.1250	6.4 .25	6.96 kg 15.34 lb	82.550 3.2500	
HH926749	120.650 4.7500	82.550 3.2500	6.4 .25	15.04 kg 33.16 lb	HH926716	279.400 11.0000	53.975 2.1250	6.4 .25	8.12 kg 17.90 lb	82.550 3.2500	
HH926749A	120.650 4.7500	82.550 3.2500	6.4 .25	15.08 kg 33.26 lb							
<b>HM926700 Series</b>											
HM926740	114.300 4.5000	49.428 1.9460	3.5 .14	6.89 kg 15.20 lb	HM926710	228.600 9.0000	38.100 1.5000	3.3 .13	2.78 kg 6.14 lb	53.975 2.1250	HM926740V : MADE FROM VACUUM MELT STEEL
*HM926740V	114.300 4.5000	49.428 1.9460	3.5 .14	6.89 kg 15.20 lb	*HM926710D	228.600 9.0000	84.138 3.3125	2.3 .09	6.52 kg 14.38 lb	115.887 4.5625	JHM926742V : MADE FROM SPECIAL STEEL
*JHM926742V	120.000 4.7244	49.428 1.9460	3.5 .14	6.47 kg 14.27 lb	*HM926710DC	228.600 9.0000	84.138 3.3125	2.3 .09	6.52 kg 14.38 lb	115.887 4.5625	HM926747TD : TAPERED BORE
HM926745	125.298 4.9330	49.428 1.9460	3.5 .14	6.09 kg 13.43 lb	*HM926710V	228.600 9.0000	38.100 1.5000	3.3 .13	2.78 kg 6.14 lb	53.975 2.1250	HM926710D : GROOVE IN OD CENTER HOLES IN OD CENTER
HM926747	127.000 5.0000	49.428 1.9460	3.5 .14	5.96 kg 13.14 lb	*HM926711V	228.600 9.0000	38.100 1.5000	3.3 .13	2.80 kg 6.18 lb	53.975 2.1250	HM926710DC : HOLES IN OD CENTER
HM926749	127.792 5.0312	49.428 1.9460	3.5 .14	5.90 kg 13.01 lb	HM926719	239.974 9.4478	38.100 1.5000	3.3 .13	4.03 kg 8.88 lb	53.975 2.1250	HM926710V : MADE FROM VACUUM MELT STEEL
*HM926747TD	127.000 5.0000	151.244 5.9545	1.5 .06	21.15 kg 46.64 lb	HM926710 *HM926710V *HM926711V	228.600 9.0000 228.600 9.0000 228.600 9.0000	38.100 1.5000 38.100 1.5000 38.100 1.5000	3.3 .13 3.3 .13 3.3 .13	2.78 kg 6.14 lb 2.78 kg 6.14 lb 2.80 kg 6.18 lb	160.338 6.3125 160.338 6.3125 160.338 6.3125	HM926711V : MADE FROM SPECIAL STEEL
HM926740NA	114.300 4.5000	57.945 2.2813	3.5 .14	14.64 kg 32.28 lb	*HM926710D *HM926710DC	228.600 9.0000 228.600 9.0000	84.138 3.3125 84.138 3.3125	2.3 .09 2.3 .09	6.52 kg 14.38 lb 6.52 kg 14.38 lb	115.890 4.5626 115.890 4.5626	
<b>929000 Series</b>											
EE929225	565.150 22.2500	146.050 5.7500	8.0 .31	- -	*929341D	863.600 34.0000	228.600 9.0000	3.3 .13	182.71 kg 402.88 lb	317.500 12.5000	929341D : GROOVE IN OD CENTER HOLES IN OD CENTER
<b>931000 Series</b>											
EE931170D	431.800 17.0000	173.038 6.8125	6.4 .25	- -	931250	635.000 25.0000	73.025 2.8750	6.4 .25	28.69 kg 63.26 lb	173.037 6.8125	

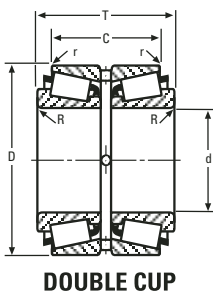
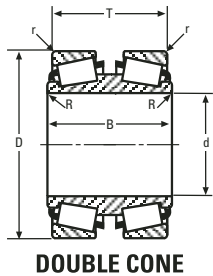
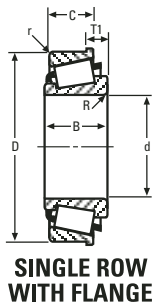
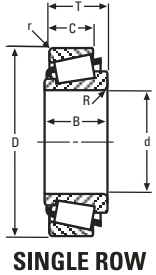

9

HH932100 SERIES CONTINUED ON NEXT PAGE

\*\*These Maximum Fillet Radii will be cleared by the Cone or Cup Radii.  
†Bore or O.D. shown are maximum dimensions. \*See Remarks Column.

HH932100 – LL957000 SERIES

CONE			Max Shaft Fillet Radii R''	Weight	CUP			Max Hs'ng Fillet Radii r''	Weight	BEARING WIDTH T	Remarks
Number	BORE d	WIDTH B			Number	OUTSIDE DIA D	WIDTH C				
HH932100 Series											
HH932132	127.000 5.0000	82.550 3.2500	6.4 .25	21.43 kg 47.26 lb	HH932110	304.800 12.0000	57.150 2.2500	6.4 .25	8.74 kg 19.28 lb	88.900 3.5000	HH932147TD: TAPERED BORE
HH932145	146.050 5.7500	82.550 3.2500	6.4 .25	18.78 kg 41.42 lb	HH932115	311.150 12.2500	57.150 2.2500	6.4 .25	9.99 kg 22.03 lb	88.900 3.5000	
*HH932147TD	147.638 5.8125	142.875 5.6250	.7 .03	43.48 kg 95.88 lb	HH932110	304.800 12.0000	57.150 2.2500	6.4 .25	8.74 kg 19.28 lb	155.575 6.1250	
					HH932115	311.150 12.2500	57.150 2.2500	6.4 .25	9.99 kg 22.03 lb	155.575 6.1250	
H936300 Series											
H936340	155.575 6.1250	79.375 3.1250	6.4 .25	22.09 kg 48.70 lb	H936310	330.200 13.0000	53.975 2.1250	6.4 .25	9.52 kg 20.99 lb	85.725 3.3750	
*H936348XX	168.275 6.6250	79.375 3.1250	6.4 .25	20.03 kg 44.16 lb	H936310XX	330.200 13.0000	53.975 2.1250	6.4 .25	9.52 kg 20.99 lb	85.725 3.3750	
H936349	168.275 6.6250	79.375 3.1250	6.4 .25	20.08 kg 44.27 lb	H936313	336.550 13.2500	53.975 2.1250	6.4 .25	10.92 kg 24.07 lb	85.725 3.3750	
*H936349XX	168.275 6.6250	79.375 3.1250	6.4 .25	20.08 kg 44.27 lb	H936316	342.900 13.5000	53.975 2.1250	6.4 .25	12.35 kg 27.22 lb	85.725 3.3750	
940000 Series											
EE941002	254.000 10.0000	74.612 2.9375	6.4 .25	- -	941950	495.300 19.5000	53.975 2.1250	3.3 .13	14.69 kg 32.40 lb	76.200 3.0000	941102DW: KEYWAY IN ID RIGHTSIDE NO SMALL RIB
EE941205	304.800 12.0000	74.612 2.9375	6.4 .25	- -	941951XD	495.300 19.5000	120.650 4.7500	1.5 .06	32.89 kg 72.52 lb	162.245 6.3876	941202DW: KEYWAY IN ID RIGHTSIDE NO SMALL RIB
*EE941205H	304.800 12.0000	74.612 2.9375	6.4 .25	36.34 kg 80.12 lb	941952XD	495.300 19.5000	127.000 5.0000	1.5 .06	36.01 kg 79.40 lb	168.595 6.6376	EE941204TD: KEYWAY IN ID TAPERED BORE
*EE941205X	304.800 12.0000	77.866 3.0656	6.4 .25	- -	*941953DC	495.300 19.5000	127.000 5.0000	1.5 .06	35.86 kg 79.08 lb	168.595 6.6376	EE941205H: NO SMALL RIB
					*941953D	495.300 19.5000	127.000 5.0000	1.5 .06	33.88 kg 74.70 lb	168.595 6.6376	EE941205X: EXTENDED SMALL RIB SHOULDER ON OD FRONTFACE
*941102DW	279.400 11.0000	120.650 4.7500	1.5 .06	- -	941950	495.300 19.5000	53.975 2.1250	3.3 .13	14.69 kg 32.40 lb	137.953 5.4312	EE941207D: EXTENDED SMALL RIB
EE941106D	279.400 11.0000	134.938 5.3125	1.5 .06	- -							941953D : GROOVE IN OD CENTER HOLES IN OD CENTER
*941202DW	304.800 12.0000	120.650 4.7500	1.5 .06	- -							941953DC : HOLES IN OD CENTER
*EE941204TD	304.800 12.0000	134.938 5.3125	3.3 .13	- -							
EE941206D	304.800 12.0000	134.938 5.3125	1.5 .06	- -							
*EE941207D	304.800 12.0000	141.288 5.5625	1.5 .06	- -							
HH949500 Series											
HH949549	228.600 9.0000	111.125 4.3750	6.4 .25	- -	HH949510	488.950 19.2500	73.025 2.8750	6.4 .25	31.30 kg 69.02 lb	123.825 4.8750	HH949510D : GROOVE IN OD CENTER HOLES IN OD CENTER
					*HH949510DC	488.950 19.2500	152.400 6.0000	1.5 .06	66.45 kg 146.52 lb	254.000 10.0000	HH949510DC : HOLES IN OD CENTER
					*HH949510D	488.950 19.2500	152.400 6.0000	1.5 .06	66.45 kg 146.52 lb	254.000 10.0000	
HH953700 Series											
HH953749	254.000 10.0000	120.650 4.7500	6.4 .25	- -	HH953710	533.400 21.0000	77.788 3.0625	6.4 .25	39.86 kg 87.88 lb	133.350 5.2500	HH953710D : GROOVE IN OD CENTER HOLES IN OD CENTER
					*HH953710DC	533.400 21.0000	165.100 6.5000	1.5 .06	86.83 kg 191.45 lb	276.224 10.8750	HH953710DC : HOLES IN OD CENTER
					*HH953710D	533.400 21.0000	165.100 6.5000	1.5 .06	86.82 kg 191.44 lb	276.224 10.8750	
LL957000 Series											
LL957049	312.738 12.3125	20.638 .8125	2.3 .09	2.20 kg 4.85 lb	LL957010	358.775 14.1250	14.288 .5625	1.5 .06	.91 kg 2.01 lb	22.225 .8750	LL957049V: MADE FROM VACUUM MELT STEEL
*LL957049V	312.738 12.3125	20.638 .8125	2.3 .09	- -	*LL957010V	358.775 14.1250	14.288 .5625	1.5 .06	.91 kg 2.01 lb	22.225 .8750	LL957010V : MADE FROM VACUUM MELT STEEL

9

\*\*These Maximum Fillet Radii will be cleared by the Cone or Cup Radii.  
†Bore or O.D. shown are maximum dimensions. \*See Remarks Column.

HM957500 – H961600 SERIES

CONE			Max Shaft Fillet Radii R <sup>**</sup>	Weight	CUP			Max Hs'ng Fillet Radii r <sup>**</sup>	Weight	BEARING WIDTH T	Remarks	
Number	BORE d	WIDTH B			Number	OUTSIDE DIA D	WIDTH C					
<b>HM957500 Series</b>												
*†JHM957540DW	300.000 11.8110	180.000 7.0866	2.5 .10	96.55 kg 212.90 lb	*†JHM957519W	479.500 18.8780	64.000 2.5197	4.0 .16	20.28 kg 44.71 lb	180.002 7.0867	JHM957540DW: EXTENDED SMALL RIB JHM957519W: HOLES IN BACKFACE KEYWAY IN OD BACKFACE	
<b>HM959300 Series</b>												
HM959347DW	305.034 12.0092	200.000 7.8740	3.3 .13	153.80 kg 339.13 lb	*HM959318	559.816 22.0400	68.250 2.6870	3.3 .13	44.70 kg 98.57 lb	200.000 7.8740	HM959348DW: KEYWAY IN RIGHTFACE HM959318: SHOULDER ON OD BACKFACE SPECIAL RADIUS ON BACKFACE OD	
*HM959348DW	305.034 12.0092	200.000 7.8740	3.3 .13	-	*HM959319A	559.948 22.0452	67.882 2.6725	6.8 .27	40.15 kg 88.53 lb	199.263 7.8450	HM959319: CHAMFER ON BACKFACE OD	
HM959349D	305.000 12.0079	169.977 6.6920	3.3 .13	-	*HM959319	559.948 22.0452	67.882 2.6725	2.0 .08	37.95 kg 83.68 lb	199.263 7.8450	HM959319A: CHAMFER ON BACKFACE OD	
<b>M959400 Series</b>												
*M959441DW	305.054 12.0100	200.025 7.8750	6.4 .25	-	M959410	499.948 19.6830	53.975 2.1250	6.4 .25	18.83 kg 41.53 lb	200.025 7.8750	M959441DW: EXTENDED SMALL RIB M959442DW: EXTENDED SMALL RIB KEYWAY IN ID	
M959442D	305.054 12.0100	200.025 7.8750	6.4 .25	-	-	-	-	-	-	-	-	
*M959442DW	305.054 12.0100	200.025 7.8750	6.4 .25	-	-	-	-	-	-	-	-	
M959447DE	317.754 12.5100	200.025 7.8750	6.4 .25	-	-	-	-	-	-	-	-	
M959442	304.800 12.0000	79.375 3.1250	6.4 .25	-	M959410	499.948 19.6830	53.975 2.1250	6.4 .25	18.83 kg 41.53 lb	101.600 4.0000	-	
<b>HM959600 Series</b>												
HM959649D	305.000 12.0079	169.977 6.6920	3.3 .13	-	*HM959618	559.867 22.0420	56.426 2.2215	1.5 .06	33.49 kg 73.84 lb	176.352 6.9430	HM959618: SHOULDER ON OD BACKFACE SPECIAL RADIUS ON BACKFACE OD	
<b>HM959700 Series</b>												
HM959741DW	305.034 12.0092	200.025 7.8750	3.3 .13	122.31 kg 269.68 lb	HM959710	499.948 19.6830	63.500 2.5000	6.4 .25	22.17 kg 48.89 lb	200.025 7.8750	HM959744DW: KEYWAY IN ID HM959719X: HOLES IN BACKFACE SHOULDER ON OD BACKFACE	
*HM959744DW	305.156 12.0140	200.025 7.8750	3.3 .13	-	*HM959719X	529.500 20.8465	70.900 2.7913	-	37.61 kg 82.94 lb	214.823 8.4576	-	
HM959739DW	305.034 12.0092	200.025 7.8750	6.4 .25	114.26 kg 251.94 lb	HM959739DW may be paired with all single cups corresponding to HM959741DW and will require -19.050 mm (-.7500 in) to be added to the T-width values.						-	-
<b>LM961500 Series</b>												
LM961548	342.900 13.5000	63.500 2.5000	3.3 .13	18.92 kg 41.72 lb	LM961510	457.098 17.9960	46.038 1.8125	3.3 .13	8.87 kg 19.57 lb	66.675 2.6250	LM961548D: ASYMMETRICAL BEARING SHOULDER ON OD RIGHTFACE	
LM961548V	342.900 13.5000	63.500 2.5000	3.3 .13	18.92 kg 41.72 lb	LM961510XD	457.098 17.9960	104.775 4.1250	1.5 .06	21.86 kg 48.19 lb	146.050 5.7500	LM961548DW: ASYMMETRICAL BEARING SHOULDER ON OD RIGHTFACE SLOTS IN RIGHTFACE	
-	-	-	-	-	LM961511	457.098 17.9960	47.625 1.8750	3.3 .13	9.34 kg 20.60 lb	68.262 2.6875	-	
-	-	-	-	-	*LM961511D	457.098 17.9960	101.600 4.0000	1.5 .06	20.15 kg 44.42 lb	142.875 5.6250	LM961511D: GROOVE IN OD CENTER HOLES IN OD CENTER	
-	-	-	-	-	LM961511V	457.098 17.9960	47.625 1.8750	3.3 .13	9.38 kg 20.69 lb	68.262 2.6875	-	
*LM961548D	343.052 13.5060	122.238 4.8125	1.5 .06	43.80 kg 96.58 lb	LM961510	457.098 17.9960	46.038 1.8125	3.3 .13	8.87 kg 19.57 lb	120.650 4.7500	-	
*LM961548DW	343.052 13.5060	122.238 4.8125	1.5 .06	43.80 kg 96.58 lb	LM961511	457.098 17.9960	47.625 1.8750	3.3 .13	9.34 kg 20.60 lb	123.825 4.8750	-	
LM961549D	343.052 13.5060	120.650 4.7500	1.5 .06	43.57 kg 96.07 lb	LM961511V	457.098 17.9960	47.625 1.8750	3.3 .13	9.38 kg 20.69 lb	123.825 4.8750	-	
LM961549DW	343.052 13.5060	120.650 4.7500	1.5 .06	43.52 kg 95.96 lb	-	-	-	-	-	-	-	
<b>H961600 Series</b>												
H961649	317.500 12.5000	131.762 5.1875	14.3 .56	-	H961610	622.300 24.5000	82.550 3.2500	12.7 .50	52.33 kg 115.39 lb	147.638 5.8125	H961610CD: GROOVE IN OD CENTER HOLES IN OD CENTER	
-	-	-	-	-	*H961610D	622.300 24.5000	174.625 6.8750	3.3 .13	113.69 kg 250.68 lb	304.800 12.0000	H961610D: GROOVE IN OD CENTER HOLES IN OD CENTER	
-	-	-	-	-	*H961610CD	622.300 24.5000	174.625 6.8750	3.3 .13	113.59 kg 250.46 lb	304.800 12.0000	-	

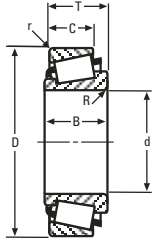

SINGLE ROW

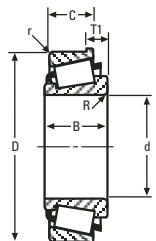

SINGLE ROW WITH FLANGE

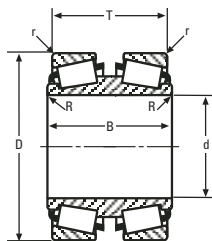

DOUBLE CONE

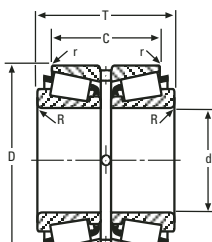

DOUBLE CUP

M966700 SERIES CONTINUED ON NEXT PAGE

\*\*These Maximum Fillet Radii will be cleared by the Cone or Cup Radii.  
†Bore or O.D. shown are maximum dimensions. \*See Remarks Column.



M966700 – LL989300 SERIES

CONE			Max Shaft Fillet Radii R''	Weight	CUP			Max Hs'ng Fillet Radii r''	Weight	BEAR-ING	Remarks
Number	BORE d	WIDTH B			Number	OUTSIDE DIA D	WIDTH C			WIDTH T	
<b>M966700 Series</b>											
*†JM966740DW	380.000 14.9606	260.000 10.2362	1.5 .06	150.60 kg 332.07 lb	*†JM966711W	567.500 22.3425	70.000 2.7559	4.0 .16	25.12 kg 55.39 lb	180.000 7.0866	JM966740DW: EXTENDED SMALL RIB
†JM966748DW	390.000 15.3543	180.000 7.0866	2.0 .08	126.44 kg 278.80 lb	*†JM966719	590.000 23.2283	110.000 4.3307	6.4 .25	67.71 kg 149.30 lb	260.000 10.2362	JM966711W : HOLES IN BACKFACE KEYWAY IN OD BACKFACE  JM966719 : GROOVE IN OD BACKFACE SHOULDER ON ID BACKFACE
<b>H969200 Series</b>											
H969249	406.400 16.0000	161.925 6.3750	12.7 .50	-	H969210	762.000 30.0000	107.950 4.2500	12.7 .50	100.77 kg 222.19 lb	180.975 7.1250	H969210D : GROOVE IN OD CENTER HOLES IN OD CENTER
					*H969210D	762.000 30.0000	222.250 8.7500	3.3 .13	211.80 kg 467.01 lb	368.300 14.5000	
<b>M969800 Series</b>											
*M969831DW	399.964 15.7466	200.000 7.8740	3.3 .13	-	M969811	649.950 25.5886	68.250 2.6870	6.4 .25	36.99 kg 81.56 lb	200.000 7.8740	M969831DW: KEYWAY IN ID M969832DW: KEYWAY IN RIGHTFACE
*M969832DW	399.964 15.7466	200.000 7.8740	3.3 .13	-							
<b>970000 Series</b>											
EE971298	329.870 12.9870	76.200 3.0000	4.8 .19	-	972100	533.400 21.0000	50.800 2.0000	3.3 .13	15.31 kg 33.75 lb	76.200 3.0000	971352D: NO SMALL RIB 972102CD : GROOVE IN OD CENTER HOLES IN OD CENTER
EE971354	342.900 13.5000	76.200 3.0000	4.8 .19	-	*972102CD	533.400 21.0000	114.300 4.5000	1.5 .06	34.21 kg 75.44 lb	165.100 6.5000	
					*972103DC	533.400 21.0000	123.825 4.8750	1.5 .06	37.84 kg 83.43 lb	174.625 6.8750	972103D : GROOVE IN OD CENTER HOLES IN OD CENTER
					*972103D	533.400 21.0000	123.825 4.8750	1.5 .06	37.84 kg 83.43 lb	174.625 6.8750	972103DC : HOLES IN OD CENTER
					*972151D	546.100 21.5000	152.400 6.0000	3.3 .13	57.84 kg 127.53 lb	177.800 7.0000	972151D : GROOVE IN OD CENTER HOLES IN OD CENTER
*971352D	342.900 13.5000	131.762 5.1875	1.5 .06	-	972100	533.400 21.0000	50.800 2.0000	3.3 .13	15.31 kg 33.75 lb	139.700 5.5000	
EE971355D	342.900 13.5000	146.050 5.7500	3.3 .13	-							
<b>LM974500 Series</b>											
LM974534DW	482.600 19.0000	200.000 7.8740	3.3 .13	236.78 kg 522.11 lb	LM974511	733.425 28.8750	68.262 2.6875	17.5 .69	37.11 kg 81.82 lb	199.263 7.8450	
LM974535DW	482.600 19.0000	200.000 7.8740	6.4 .25	-	LM974535DW may be paired with all single cups corresponding to LM974534DW and will require .737 mm (.0290 in) to be added to the T-width values.						
<b>LM975300 Series</b>											
*LM975339DW	509.948 20.0767	200.025 7.8750	3.3 .13	228.52 kg 503.88 lb	LM975311	733.425 28.8750	69.482 2.7355	4.8 .19	35.94 kg 79.24 lb	199.263 7.8450	LM975339DW: KEYWAY IN LEFTFACE
LM975340DW	509.948 20.0767	200.025 7.8750	3.3 .13	224.51 kg 495.05 lb							
<b>980000 Series</b>											
EE982003	508.000 20.0000	81.758 3.2188	6.4 .25	-	982900	736.600 29.0000	53.975 2.1250	3.3 .13	28.73 kg 63.35 lb	88.900 3.5000	982025D: NO SMALL RIB 982901CD : GROOVE IN OD CENTER HOLES IN OD CENTER
EE982028	514.350 20.2500	81.758 3.2188	6.4 .25	-	*982901CD	736.600 29.0000	114.300 4.5000	1.5 .06	60.18 kg 132.69 lb	186.502 7.3426	
EE982051	520.700 20.5000	81.758 3.2188	6.4 .25	-							
*982025D	514.350 20.2500	127.000 5.0000	3.3 .13	-	982900	736.600 29.0000	53.975 2.1250	3.3 .13	28.73 kg 63.35 lb	154.400 6.0788	
<b>LM985000 Series</b>											
*†JLM985049DW	800.000 31.4961	300.000 11.8110	1.5 .06	-	†JLM985010	1100.000 43.3071	114.000 4.4882	6.0 .24	145.68 kg 321.23 lb	300.000 11.8110	JLM985049DW: KEYWAY IN RIGHTFACE
<b>LM986900 Series</b>											
LM986949	863.600 34.0000	196.850 7.7500	28.7 1.13	-	*LM986910D	1371.600 54.0000	285.750 11.2500	6.4 .25	728.63 kg 1606.62 lb	469.890 18.4996	LM986910D : GROOVE IN OD CENTER HOLES IN OD CENTER
<b>LL989300 Series</b>											
LL989349	1431.925 56.3750	57.150 2.2500	6.4 .25	-	LL989310XD	1584.325 62.3750	79.375 3.1250	3.3 .13	68.81 kg 151.72 lb	130.175 5.1250	

9

\*These Maximum Fillet Radii will be cleared by the Cone or Cup Radii.  
†Bore or O.D. shown are maximum dimensions. \*See Remarks Column.



## THE TIMKEN® ISOCLASS™ BEARING SPECTRUM

### Standard IsoClass Bearings

The 30000 series bearings included in the original ISO/R 355 standard, often referenced as DIN720, now constitute the core of the IsoClass line of metric bearings.

### Customized IsoClass Bearings

Modified and flanged IsoClass bearings are indicated by prefixes and/or suffixes to the basic part number. These bearings are not interchangeable with bearings sharing the same basic part number.

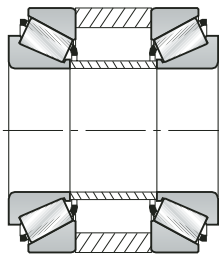

IsoClass Spacer Assemblies

### IsoClass Spacer Assemblies

A wide range of spacer assemblies is available for numerous applications in the original-equipment and replacement markets.

Most single-row standard IsoClass bearings can be supplied as a two-row, pre-set, ready-to-fit assembly by adding spacers machined to pre-determined dimensions and tolerances.

For details, please contact your Timken sales representative.

### Modified IsoClass Bearings

Timken has developed modified ISO 355 bearing designs to meet specific application requirements. These bearings have a modified external configuration or internal geometry.

### Flanged IsoClass Bearings

A variation on standard IsoClass bearings, the flanged outer race facilitates axial location and accurately aligned seats in a through-bored housing.

10

Original ISO/R 355 Part Numbering System

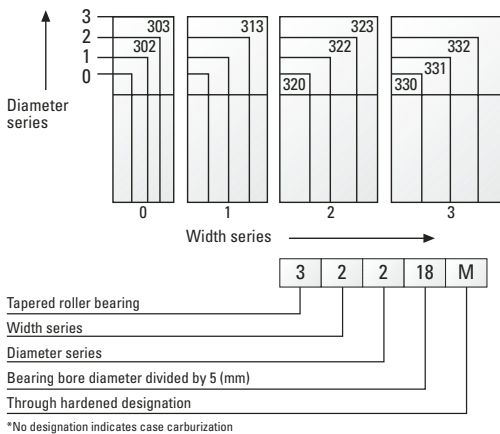

## ISO STANDARDS

The ISO 355 international metric standard defines dimensions and cup angles for single-row tapered roller bearings. Originally intended to replace the ISO/R 355 standard, the new ISO 355 standard defined additional bearings and created new designation codes for the entire dimensional spectrum of ISO 355 metric bearings.

Because new designation codes would have incurred expense for many manufacturers and users, the market retained the designation codes for bearings that were in accordance with both the old and new standards.

Comparison of ISO bearing designs (55 mm bore diameter)

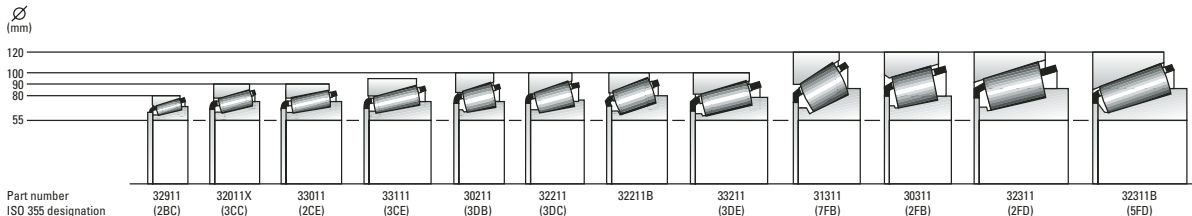

ISOCCLASS BEARINGS

CONE (Inner Race) number	CUP (Outer Race) number	Cone BORE d	Cup OUTSIDE DIA. D	Bearing WIDTH T	Cone WIDTH B	Cup WIDTH C	Max. Shaft Fillet Radii R	Max. Hsng. Fillet Radii r	Weight
X30203	Y30203	17.000 0.6693	40.000 1.5748	13.250 0.5217	12.000 0.4724	11.000 0.4331	1.0 0.04	1.0 0.04	0.08 kg 0.18 lb
X30204	Y30204	20.000 0.7874	47.000 1.8504	15.250 0.6004	14.000 0.5512	12.000 0.4724	1.0 0.04	1.0 0.04	0.13 kg 0.28 lb
X30204	Y30204Z	20.000 0.7874	47.000 1.8504	15.250 0.6004	14.000 0.5512	12.000 0.4724	1.0 0.04	1.0 0.04	0.13 kg 0.28 lb
X30204M	Y30204M	20.000 0.7874	47.000 1.8504	15.250 0.6004	14.000 0.5512	12.000 0.4724	1.0 0.04	1.0 0.04	0.13 kg 0.28 lb
X30205	Y30205	25.000 0.9843	52.000 2.0472	16.250 0.6398	15.000 0.5906	13.000 0.5118	1.0 0.04	1.0 0.04	0.15 kg 0.33 lb
X30205	YAA30205	25.000 0.9843	52.000 2.0472	16.250 0.6398	15.000 0.5906	13.000 0.5118	1.0 0.04	1.5 0.06	0.15 kg 0.33 lb
X30205M	Y30205M	25.000 0.9843	52.000 2.0472	16.250 0.6398	15.000 0.5906	13.000 0.5118	1.0 0.04	1.0 0.04	0.15 kg 0.33 lb
XAA30205	Y30205	25.000 0.9843	52.000 2.0472	16.250 0.6398	15.000 0.5906	13.000 0.5118	4.0 0.16	1.0 0.04	0.15 kg 0.33 lb
XAA30205	YAA30205	25.000 0.9843	52.000 2.0472	16.250 0.6398	15.000 0.5906	13.000 0.5118	4.0 0.16	1.5 0.06	0.15 kg 0.33 lb
X30206	Y30206	30.000 1.1811	62.000 2.4409	17.250 0.6791	16.000 0.6299	14.000 0.5512	1.0 0.04	1.0 0.04	0.23 kg 0.51 lb
X30206M	Y30206M	30.000 1.1811	62.000 2.4409	17.250 0.6791	16.000 0.6299	14.000 0.5512	1.0 0.04	1.0 0.04	0.24 kg 0.53 lb
X30207	Y30207	35.000 1.3780	72.000 2.8346	18.250 0.7185	17.000 0.6693	15.000 0.5906	1.5 0.06	1.5 0.06	0.33 kg 0.72 lb
X30207M	Y30207M	35.000 1.3780	72.000 2.8346	18.250 0.7185	17.000 0.6693	15.000 0.5906	1.5 0.06	1.5 0.06	0.34 kg 0.75 lb
X30208	Y30208	40.000 1.5748	80.000 3.1496	19.750 0.7776	18.000 0.7087	16.000 0.6299	1.5 0.06	1.5 0.06	0.43 kg 0.95 lb
X30208M	Y30208M	40.000 1.5748	80.000 3.1496	19.750 0.7776	18.000 0.7087	16.000 0.6299	1.5 0.06	1.5 0.06	0.43 kg 0.95 lb
X30209	Y30209	45.000 1.7717	85.000 3.3465	20.750 0.8169	19.000 0.7480	16.000 0.6299	1.5 0.06	1.5 0.06	0.49 kg 1.07 lb
X30209M	Y30209M	45.000 1.7717	85.000 3.3465	20.750 0.8169	19.000 0.7480	16.000 0.6299	1.5 0.06	1.5 0.06	0.46 kg 1.01 lb
X30210	Y30210	50.000 1.9685	90.000 3.5433	21.750 0.8563	20.000 0.7874	17.000 0.6693	1.5 0.06	1.5 0.06	0.55 kg 1.21 lb
X30210M	Y30210M	50.000 1.9685	90.000 3.5433	21.750 0.8563	20.000 0.7874	17.000 0.6693	1.5 0.06	1.5 0.06	0.55 kg 1.22 lb
X30210M	*Y30210RM	50.000 1.9685	90.000 3.5433	8.750 0.3445	20.000 0.7874	17.000 0.6693	1.5 0.06	1.5 0.06	0.54 kg 1.19 lb
XGA30210	Y30210	52.000 2.0472	90.000 3.5433	21.750 0.8563	20.000 0.7874	17.000 0.6693	4.0 0.16	1.5 0.06	0.52 kg 1.15 lb
X30211	Y30211	55.000 2.1654	100.000 3.9370	22.750 0.8957	21.000 0.8268	18.000 0.7087	2.0 0.08	1.5 0.06	0.72 kg 1.58 lb
X30211M	Y30211M	55.000 2.1654	100.000 3.9370	22.750 0.8957	21.000 0.8268	18.000 0.7087	2.0 0.08	1.5 0.06	0.73 kg 1.62 lb
X30212	Y30212	60.000 2.3622	110.000 4.3307	23.750 0.9350	22.000 0.8661	19.000 0.7480	2.0 0.08	1.5 0.06	0.89 kg 1.97 lb
X30212M	Y30212M	60.000 2.3622	110.000 4.3307	23.750 0.9350	22.000 0.8661	19.000 0.7480	2.0 0.08	1.5 0.06	0.89 kg 1.97 lb
X30213	Y30213	65.000 2.5591	120.000 4.7244	24.750 0.9744	23.000 0.9055	20.000 0.7874	2.0 0.08	1.5 0.06	1.15 kg 2.52 lb
X30213M	Y30213M	65.000 2.5591	120.000 4.7244	24.750 0.9744	23.000 0.9055	20.000 0.7874	2.0 0.08	1.5 0.06	1.16 kg 2.56 lb
X30214	Y30214	70.000 2.7559	125.000 4.9213	26.250 1.0335	24.000 0.9449	21.000 0.8268	2.0 0.08	1.5 0.06	1.26 kg 2.79 lb
X30214M	Y30214M	70.000 2.7559	125.000 4.9213	26.250 1.0335	24.000 0.9449	21.000 0.8268	2.0 0.08	1.5 0.06	1.30 kg 2.87 lb
X30215	Y30215	75.000 2.9528	130.000 5.1181	27.250 1.0728	25.000 0.9843	22.000 0.8661	2.0 0.08	1.5 0.06	1.35 kg 2.97 lb
X30215M	Y30215M	75.000 2.9528	130.000 5.1181	27.250 1.0728	25.000 0.9843	22.000 0.8661	2.0 0.08	1.5 0.06	1.40 kg 3.09 lb
X30216	Y30216	80.000 3.1496	140.000 5.5118	28.250 1.1122	26.000 1.0236	22.000 0.8661	2.5 0.10	2.0 0.08	1.63 kg 3.59 lb
X30216M	Y30216M	80.000 3.1496	140.000 5.5118	28.250 1.1122	26.000 1.0236	22.000 0.8661	2.5 0.10	2.0 0.08	1.67 kg 3.67 lb
X30216	YFA30216	80.000 3.1496	141.000 5.5512	28.250 1.1122	26.000 1.0236	22.000 0.8661	2.5 0.1	2.0 0.08	1.66 kg 3.67 lb
X30216	YHA30216	80.000 3.1496	150.000 5.9055	30.550 1.2028	26.000 1.0236	24.300 0.9567	2.5 0.1	0.8 0.03	2.14 kg 4.72 lb

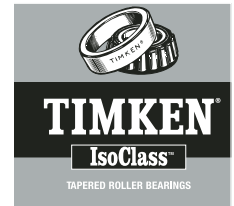

10

\* Flanged cup, Bearing width is T1 Dimension

# ISOCCLASS BEARINGS

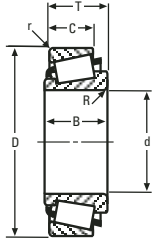

**SINGLE ROW**

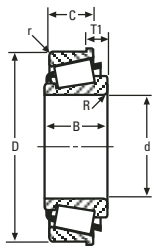

**SINGLE ROW WITH FLANGE**

CONE (Inner Race) number	CUP (Outer Race) number	Cone BORE d	Cup OUTSIDE DIA. D	Bearing WIDTH T	Cone WIDTH B	Cup WIDTH C	Max. Shaft Fillet Radii R	Max. Hsng. Fillet Radii r	Weight
XUA30216	Y30216	70.000 2.7559	140.000 5.5118	28.250 1.1122	30.500 1.2028	22.000 0.8661	2.5 0.1	2.0 0.08	2.01 kg 4.44 lb
XUA30216	YFA30216	70.000 2.7559	141.000 5.5512	28.250 1.1122	30.500 1.2028	22.000 0.8661	2.5 0.1	2.0 0.08	2.05 kg 4.52 lb
XUA30216	YHA30216	70.000 2.7559	150.000 5.9055	30.550 1.2028	30.600 1.2047	24.300 0.9567	2.5 0.10	0.8 0.03	2.53 kg 5.57 lb
XUB30216	Y30216	80.000 3.1496	140.000 5.5118	30.250 1.1909	28.000 1.1024	22.000 0.8661	0.5 0.02	2.0 0.08	1.77 kg 3.90 lb
XUB30216	YFA30216	80.000 3.1496	141.000 5.5512	30.250 1.1909	28.000 1.1024	22.000 0.8661	0.5 0.02	2.0 0.08	1.81 kg 3.98 lb
XUB30216	YHA30216	80.000 3.1496	150.000 5.9055	32.550 1.2816	28.000 1.1024	24.300 0.9567	0.5 0.02	0.8 0.03	2.28 kg 5.03 lb
X30217	Y30217	85.000 3.3465	150.000 5.9055	30.500 1.2008	28.000 1.1024	24.000 0.9449	2.5 0.10	2.0 0.08	2.10 kg 4.63 lb
X30217M	Y30217M	85.000 3.3465	150.000 5.9055	30.500 1.2008	28.000 1.1024	24.000 0.9449	2.5 0.10	2.0 0.08	2.06 kg 4.54 lb
X30218	Y30218	90.000 3.5433	160.000 6.2992	32.500 1.2795	30.000 1.1811	26.000 1.0236	2.5 0.10	2.0 0.08	2.56 kg 5.65 lb
X30218M	Y30218M	90.000 3.5433	160.000 6.2992	32.500 1.2795	30.000 1.1811	26.000 1.0236	2.5 0.10	2.0 0.08	2.62 kg 5.78 lb
X30219	Y30219	95.000 3.7402	170.000 6.6929	34.500 1.3583	32.000 1.2598	27.000 1.0630	3.0 0.12	2.5 0.10	3.05 kg 6.73 lb
X30219M	Y30219M	95.000 3.7402	170.000 6.6929	34.500 1.3583	32.000 1.2598	27.000 1.0630	3.0 0.12	2.5 0.10	3.14 kg 6.92 lb
X30220	Y30220	100.000 3.9370	180.000 7.0866	37.000 1.4567	34.000 1.3386	29.000 1.1417	3.0 0.12	2.5 0.10	3.86 kg 8.50 lb
X30220M	Y30220M	100.000 3.9370	180.000 7.0866	37.000 1.4567	34.000 1.3386	29.000 1.1417	3.0 0.12	2.5 0.10	3.76 kg 8.30 lb
X30221	Y30221	105.000 4.1339	190.000 7.4803	39.000 1.5354	36.000 1.4173	30.000 1.1811	3.0 0.12	2.5 0.10	4.50 kg 9.93 lb
X30221M	Y30221M	105.000 4.1339	190.000 7.4803	39.000 1.5354	36.000 1.4173	30.000 1.1811	3.0 0.12	2.5 0.10	4.49 kg 9.90 lb
X30222	Y30222	110.000 4.3307	200.000 7.8740	41.000 1.6142	38.000 1.4961	32.000 1.2598	3.0 0.12	2.5 0.10	5.19 kg 11.43 lb
X30222M	Y30222M	110.000 4.3307	200.000 7.8740	41.000 1.6142	38.000 1.4961	32.000 1.2598	3.0 0.12	2.5 0.10	5.23 kg 11.54 lb
X30224M	Y30224M	120.000 4.7244	215.000 8.4646	43.500 1.7126	40.000 1.5748	34.000 1.3386	3.0 0.12	2.5 0.10	6.23 kg 13.73 lb
X30226M	Y30226M	130.000 5.1181	230.000 9.0551	43.750 1.7224	40.000 1.5748	34.000 1.3386	4.0 0.16	3.0 0.12	7.05 kg 15.55 lb
X30228	Y30228	140.000 5.5118	250.000 9.8425	45.750 1.8012	42.000 1.6535	36.000 1.4173	4.1 0.16	3.0 0.12	9.02 kg 19.89 lb
X30228M	Y30228M	140.000 5.5118	250.000 9.8425	45.750 1.8012	42.000 1.6535	36.000 1.4173	4.0 0.16	3.0 0.12	8.92 kg 19.66 lb
X30230M	Y30230M	150.000 5.9055	270.000 10.6299	49.000 1.9291	45.000 1.7717	38.000 1.4961	4.0 0.16	3.0 0.12	11.08 kg 24.42 lb
X30302	Y30302	15.000 0.5906	42.000 1.6535	14.250 0.5610	13.000 0.5118	11.000 0.4331	1.0 0.04	1.0 0.04	0.10 kg 0.22 lb
X30303	Y30303	17.000 0.6693	47.000 1.8504	15.250 0.6004	14.000 0.5512	12.000 0.4724	1.0 0.04	1.0 0.04	0.13 kg 0.29 lb
X30304	Y30304	20.000 0.7874	52.000 2.0472	16.250 0.6398	15.000 0.5906	13.000 0.5118	1.5 0.06	1.5 0.06	0.18 kg 0.39 lb
X30305	Y30305	25.000 0.9843	62.000 2.4409	18.250 0.7185	17.000 0.6693	15.000 0.5906	1.5 0.06	1.5 0.06	0.27 kg 0.60 lb
X30305M	Y30305M	25.000 0.9843	62.000 2.4409	18.250 0.7185	17.000 0.6693	15.000 0.5906	1.5 0.06	1.5 0.06	0.26 kg 0.57 lb
X30306	Y30306	30.000 1.1811	72.000 2.8346	20.750 0.8169	19.000 0.7480	16.000 0.6299	1.5 0.06	1.5 0.06	0.40 kg 0.88 lb
X30306M	Y30306M	30.000 1.1811	72.000 2.8346	20.750 0.8169	19.000 0.7480	16.000 0.6299	1.5 0.06	1.5 0.06	0.38 kg 0.84 lb
X30307	Y30307	35.000 1.3780	80.000 3.1496	22.750 0.8957	21.000 0.8268	18.000 0.7087	2.0 0.08	1.5 0.06	0.54 kg 1.18 lb
X30307M	Y30307M	35.000 1.3780	80.000 3.1496	22.750 0.8957	21.000 0.8268	18.000 0.7087	2.0 0.08	1.5 0.06	0.53 kg 1.16 lb
X30308	Y30308	40.000 1.5748	90.000 3.5433	25.250 0.9941	23.000 0.9055	20.000 0.7874	2.0 0.08	1.5 0.06	0.74 kg 1.63 lb
X30308M	Y30308M	40.000 1.5748	90.000 3.5433	25.250 0.9941	23.000 0.9055	20.000 0.7874	2.0 0.08	1.5 0.06	0.74 kg 1.62 lb

\* Flanged cup, Bearing width is T1 Dimension



ISOCCLASS BEARINGS

CONE (Inner Race) number	CUP (Outer Race) number	Cone BORE d	Cup OUTSIDE DIA. D	Bearing WIDTH T	Cone WIDTH B	Cup WIDTH C	Max. Shaft Fillet Radii R	Max. Hsng. Fillet Radii r	Weight
X30308M	*Y30308RM	40.000 1.5748	90.000 3.5433	10.250 0.4035	23.000 0.9055	20.000 0.7874	2.0 0.08	1.5 0.06	0.75 kg 1.65 lb
X30309	Y30309	45.000 1.7717	100.000 3.9370	27.250 1.0728	25.000 0.9843	22.000 0.8661	2.0 0.08	1.5 0.06	1.00 kg 2.21 lb
X30309M	Y30309M	45.000 1.7717	100.000 3.9370	27.250 1.0728	25.000 0.9843	22.000 0.8661	2.0 0.08	1.5 0.06	0.99 kg 2.19 lb
X30309M	*Y30309RM	45.000 1.7717	100.000 3.9370	10.250 0.4035	25.000 0.9843	22.000 0.8661	2.0 0.08	1.5 0.06	0.97 kg 2.14 lb
XFA30309M	Y30309M	47.500 1.8701	100.000 3.9370	27.250 1.0728	25.000 0.9843	22.000 0.8661	2.0 0.08	1.5 0.06	0.95 kg 2.09 lb
X30310	Y30310	50.000 1.9685	110.000 4.3307	29.250 1.1516	27.000 1.0630	23.000 0.9055	2.5 0.10	2.0 0.08	1.27 kg 2.80 lb
X30310M	Y30310M	50.000 1.9685	110.000 4.3307	29.250 1.1516	27.000 1.0630	23.000 0.9055	2.5 0.10	2.0 0.08	1.25 kg 2.76 lb
X30310M	*Y30310RM	50.000 1.9685	110.000 4.3307	11.250 0.4429	27.000 1.0630	23.000 0.9055	2.5 0.10	2.0 0.08	1.25 kg 2.76 lb
X30311	Y30311	55.000 2.1654	120.000 4.7244	31.500 1.2402	29.000 1.1417	25.000 0.9843	2.5 0.10	2.0 0.08	1.62 kg 3.56 lb
X30312	Y30312	60.000 2.3622	130.000 5.1181	33.500 1.3189	31.000 1.2205	26.000 1.0236	3.0 0.12	2.5 0.10	1.96 kg 4.32 lb
X30312M	Y30312M	60.000 2.3622	130.000 5.1181	33.500 1.3189	31.000 1.2205	26.000 1.0236	3.0 0.12	2.5 0.10	1.95 kg 4.30 lb
X30313	Y30313	65.000 2.5591	140.000 5.5118	36.000 1.4173	33.000 1.2992	28.000 1.1024	3.0 0.12	2.5 0.10	2.49 kg 5.50 lb
X30314	Y30314	70.000 2.7559	150.000 5.9055	38.000 1.4961	35.000 1.3780	30.000 1.1811	3.0 0.12	2.5 0.10	3.01 kg 6.64 lb
X30315	Y30315	75.000 2.9528	160.000 6.2992	40.000 1.5748	37.000 1.4567	31.000 1.2205	3.0 0.12	2.5 0.1	3.69 kg 8.15 lb
X30315M	Y30315M	75.000 2.9528	160.000 6.2992	40.000 1.5748	37.000 1.4567	31.000 1.2205	3.0 0.12	2.5 0.10	3.60 kg 7.94 lb
X30316	Y30316	80.000 3.1496	170.000 6.6929	42.500 1.6732	39.000 1.5354	33.000 1.2992	3.0 0.12	2.5 0.10	4.10 kg 9.04 lb
X30316M	Y30316M	80.000 3.1496	170.000 6.6929	42.500 1.6732	39.000 1.5354	33.000 1.2992	3.0 0.12	2.5 0.10	4.33 kg 9.54 lb
X30317M	Y30317M	85.000 3.3465	180.000 7.0866	44.500 1.7520	41.000 1.6142	34.000 1.3386	4.0 0.16	3.0 0.12	4.78 kg 10.55 lb
X31307	Y31307	35.000 1.3780	80.000 3.1496	22.750 0.8957	21.000 0.8268	15.000 0.5906	2.0 0.08	1.5 0.06	0.52 kg 1.15 lb
X31308	Y31308	40.000 1.5748	90.000 3.5433	25.250 0.9941	23.000 0.9055	17.000 0.6693	2.0 0.08	1.5 0.06	0.73 kg 1.61 lb
X31309M	Y31309M	45.000 1.7717	100.000 3.9370	27.250 1.0728	25.000 0.9843	18.000 0.7087	2.0 0.08	1.5 0.06	0.94 kg 2.08 lb
X31310M	Y31310M	50.000 1.9685	110.000 4.3307	29.250 1.1516	27.000 1.0630	19.000 0.7480	2.5 0.10	2.0 0.08	1.21 kg 2.66 lb
X31311M	Y31311M	55.000 2.1654	120.000 4.7244	31.500 1.2402	29.000 1.1417	21.000 0.8268	2.5 0.10	2.0 0.08	1.55 kg 3.42 lb
X31312M	Y31312M	60.000 2.3622	130.000 5.1181	33.500 1.3189	31.000 1.2205	22.000 0.8661	3.0 0.12	2.5 0.10	1.96 kg 4.32 lb
X31313M	Y31313M	65.000 2.5591	140.000 5.5118	36.000 1.4173	33.000 1.2992	23.000 0.9055	3.0 0.12	2.5 0.10	2.41 kg 5.32 lb
X31314	Y31314	70.000 2.7559	150.000 5.9055	38.000 1.4961	35.000 1.3780	25.000 0.9843	3.0 0.12	2.5 0.1	2.92 kg 6.44 lb
X31314M	Y31314M	70.000 2.7559	150.000 5.9055	38.000 1.4961	35.000 1.3780	25.000 0.9843	3.0 0.12	2.5 0.10	2.93 kg 6.47 lb
X31315M	Y31315M	75.000 2.9528	160.000 6.2992	40.000 1.5748	37.000 1.4567	26.000 1.0236	3.0 0.12	2.5 0.10	3.46 kg 7.64 lb
X31318M	Y31318M	90.000 3.5433	190.000 7.4803	46.500 1.8307	43.000 1.6929	30.000 1.1811	4.0 0.16	3.0 0.12	5.54 kg 12.22 lb
X32004X	Y32004X	20.000 0.7874	42.000 1.6535	15.000 0.5906	15.000 0.5906	12.000 0.4724	0.6 0.02	0.6 0.02	0.10 kg 0.21 lb
X32004X	YAA32004X	20.000 0.7874	42.000 1.6535	15.000 0.5906	15.000 0.5906	12.000 0.4724	0.6 0.02	1.0 0.04	0.10 kg 0.21 lb
XAA32004X	Y32004X	20.000 0.7874	42.000 1.6535	15.000 0.5906	15.000 0.5906	12.000 0.4724	2.0 0.08	0.6 0.02	0.10 kg 0.21 lb
XAA32004X	YAA32004X	20.000 0.7874	42.000 1.6535	15.000 0.5906	15.000 0.5906	12.000 0.4724	2.0 0.08	1.0 0.04	0.10 kg 0.21 lb

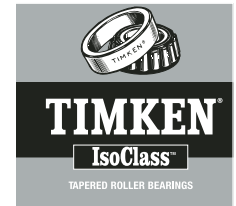

10

\* Flanged cup, Bearing width is T1 Dimension

**ISOCCLASS BEARINGS**

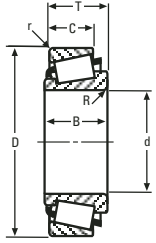

**SINGLE ROW**

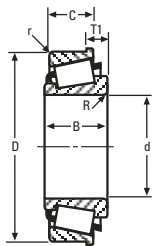

**SINGLE ROW WITH FLANGE**

CONE (Inner Race) number	CUP (Outer Race) number	Cone BORE d	Cup OUTSIDE DIA. D	Bearing WIDTH T	Cone WIDTH B	Cup WIDTH C	Max. Shaft Fillet Radii R	Max. Hsng. Fillet Radii r	Weight
X32005X	Y32005X	25.000 0.9843	47.000 1.8504	15.000 0.5906	15.000 0.5906	11.500 0.4528	0.6 0.02	0.6 0.02	0.11 kg 0.25 lb
X32005X	YAA32005X	25.000 0.9843	47.000 1.8504	15.000 0.5906	15.000 0.5906	11.500 0.4528	0.6 0.02	1.0 0.04	0.11 kg 0.25 lb
XAA32005X	Y32005X	25.000 0.9843	47.000 1.8504	15.000 0.5906	15.000 0.5906	11.500 0.4528	3.3 0.13	0.6 0.02	0.11 kg 0.25 lb
XAA32005X	YAA32005X	25.000 0.9843	47.000 1.8504	15.000 0.5906	15.000 0.5906	11.500 0.4528	3.3 0.13	1.0 0.04	0.11 kg 0.25 lb
X32006X	Y32006X	30.000 1.1811	55.000 2.1654	17.000 0.6693	17.000 0.6693	13.000 0.5118	1.0 0.04	1.0 0.04	0.17 kg 0.38 lb
X32006X	YGA32006X	30.000 1.1811	62.000 2.4409	17.000 0.6693	17.000 0.6693	13.000 0.5118	1.0 0.04	1.0 0.04	0.24 kg 0.53 lb
X32007X	Y32007X	35.000 1.3780	62.000 2.4409	18.000 0.7087	18.000 0.7087	14.000 0.5512	1.0 0.04	1.0 0.04	0.23 kg 0.50 lb
X32008X	Y32008X	40.000 1.5748	68.000 2.6772	19.000 0.7480	19.000 0.7480	14.500 0.5709	1.0 0.04	1.0 0.04	0.27 kg 0.61 lb
X32008X	Y32008XZ	40.000 1.5748	68.000 2.6772	19.000 0.7480	19.000 0.7480	14.500 0.5709	1.0 0.04	1.0 0.04	0.27 kg 0.61 lb
X32008XM	Y32008XM	40.000 1.5748	68.000 2.6772	19.000 0.7480	19.000 0.7480	14.500 0.5709	1.0 0.04	1.0 0.04	0.27 kg 0.60 lb
XAA32008X	Y32008X	40.000 1.5748	68.000 2.6772	19.000 0.7480	19.000 0.7480	14.500 0.5709	3.5 0.14	1.0 0.04	0.27 kg 0.61 lb
XAA32008X	Y32008XZ	40.000 1.5748	68.000 2.6772	19.000 0.7480	19.000 0.7480	14.500 0.5709	3.6 0.14	1.0 0.04	0.27 kg 0.61 lb
XKA32008XF	Y32008X	41.000 1.6142	68.000 2.6772	19.000 0.7480	21.000 0.8268	14.500 0.5709	2.0 0.08	1.0 0.04	0.27 kg 0.61 lb
XKA32008XF	Y32008XZ	41.000 1.6142	68.000 2.6772	19.000 0.7480	21.000 0.8268	14.500 0.5709	2.0 0.08	1.0 0.04	0.27 kg 0.60 lb
X32009X	Y32009X	45.000 1.7717	75.000 2.9528	20.000 0.7874	20.000 0.7874	15.500 0.6102	1.0 0.04	1.0 0.04	0.35 kg 0.76 lb
X32009X	*Y32009XR	45.000 1.7717	75.000 2.9528	8.000 0.3150	20.000 0.7874	15.500 0.6102	1.0 0.04	1.0 0.04	0.36 kg 0.79 lb
X32009XM	Y32009XM	45.000 1.7717	75.000 2.9528	20.000 0.7874	20.000 0.7874	15.500 0.6102	1.0 0.04	1.0 0.04	0.33 kg 0.73 lb
XAA32009X	Y32009X	45.000 1.7717	75.000 2.9528	20.000 0.7874	20.000 0.7874	15.500 0.6102	3.0 0.12	1.0 0.04	0.35 kg 0.76 lb
XAA32009X	*Y32009XR	45.000 1.7717	75.000 2.9528	8.000 0.3150	20.000 0.7874	15.500 0.6102	3.0 0.12	1.0 0.04	0.36 kg 0.79 lb
XAB32009X	Y32009X	45.000 1.7717	75.000 2.9528	20.000 0.7874	20.000 0.7874	15.500 0.6102	0.0 0.00	1.0 0.04	0.34 kg 0.76 lb
XAB32009X	*Y32009XR	45.000 1.7717	75.000 2.9528	8.000 0.3150	20.000 0.7874	15.500 0.6102	0.0 0.00	1.0 0.04	0.36 kg 0.79 lb
X32010X	Y32010X	50.000 1.9685	80.000 3.1496	20.000 0.7874	20.000 0.7874	15.500 0.6102	1.0 0.04	1.0 0.04	0.37 kg 0.82 lb
X32010X	YKA32010X	50.000 1.9685	82.000 3.2283	26.000 1.0236	20.000 0.7874	21.500 0.8465	1.0 0.04	1.3 0.05	0.49 kg 1.08 lb
X32010X	YKB32010X	50.000 1.9685	82.000 3.2283	21.500 0.8465	20.000 0.7874	17.000 0.6693	1.0 0.04	0.5 0.02	0.42 kg 0.94 lb
XAA32010X	Y32010X	50.000 1.9685	80.000 3.1496	20.000 0.7874	20.000 0.7874	15.500 0.6102	2.3 0.09	1.0 0.04	0.57 kg 1.25 lb
XAA32010X	YKA32010X	50.000 1.9685	82.000 3.2283	26.000 1.0236	20.000 0.7874	21.500 0.8465	2.3 0.09	1.3 0.05	0.49 kg 1.08 lb
XAA32010X	YKB32010X	50.000 1.9685	82.000 3.2283	21.500 0.8465	20.000 0.7874	17.000 0.6693	2.3 0.09	0.5 0.02	0.42 kg 0.94 lb
XAB32010X	Y32010X	50.000 1.9685	80.000 3.1496	20.000 0.7874	20.000 0.7874	15.500 0.6102	3.0 0.12	1.0 0.04	0.37 kg 0.82 lb
XAB32010X	YKA32010X	50.000 1.9685	82.000 3.2283	26.000 1.0236	20.000 0.7874	21.500 0.8465	3.0 0.12	1.3 0.05	0.49 kg 1.08 lb
XAB32010X	YKB32010X	50.000 1.9685	82.000 3.2283	21.500 0.8465	20.000 0.7874	17.000 0.6693	3.0 0.12	0.5 0.02	0.42 kg 0.94 lb
XAC32010X	Y32010X	50.000 1.9685	80.000 3.1496	20.000 0.7874	20.000 0.7874	15.500 0.6102	0.5 0.02	1.0 0.04	0.37 kg 0.82 lb
XAC32010X	YKA32010X	50.000 1.9685	82.000 3.2283	26.000 1.0236	20.000 0.7874	21.500 0.8465	0.5 0.02	1.3 0.05	0.46 kg 1.01 lb
XAC32010X	YKB32010X	50.000 1.9685	82.000 3.2283	21.500 0.8465	20.000 0.7874	17.000 0.6693	0.5 0.02	0.5 0.02	0.40 kg 0.88 lb
XAD32010X	Y32010X	50.000 1.9685	80.000 3.1496	20.000 0.7874	20.000 0.7874	15.500 0.6102	1.5 0.06	1.0 0.04	0.37 kg 0.82 lb
XAD32010X	YKA32010X	50.000 1.9685	82.000 3.2283	26.000 1.0236	20.000 0.7874	21.500 0.8465	1.5 0.06	1.3 0.05	0.49 kg 1.08 lb

\* Flanged cup, Bearing width is T1 Dimension

10

ISOCCLASS BEARINGS

CONE (Inner Race) number	CUP (Outer Race) number	Cone BORE d	Cup OUTSIDE DIA. D	Bearing WIDTH T	Cone WIDTH B	Cup WIDTH C	Max. Shaft Fillet Radii R	Max. Hsng. Fillet Radii r	Weight
XAD32010X	YKB32010X	50.000 1.9685	82.000 3.2283	21.500 0.8465	20.000 0.7874	17.000 0.6693	1.5 0.06	0.5 0.02	0.42 kg 0.94 lb
XAE32010X	Y32010X	50.000 1.9685	80.000 3.1496	20.000 0.7874	20.000 0.7874	15.500 0.6102	0.3 0.01	1.0 0.04	0.37 kg 0.82 lb
XAE32010X	YKA32010X	50.000 1.9685	82.000 3.2283	26.000 1.0236	20.000 0.7874	21.500 0.8465	0.3 0.01	1.3 0.05	0.49 kg 1.08 lb
XAE32010X	YKB32010X	50.000 1.9685	82.000 3.2283	21.500 0.8465	20.000 0.7874	17.000 0.6693	0.3 0.01	0.5 0.02	0.42 kg 0.94 lb
X32011X	Y32011X	55.000 2.1654	90.000 3.5433	23.000 0.9055	23.000 0.9055	17.500 0.6890	1.5 0.06	1.5 0.06	0.57 kg 1.25 lb
X32011XM	Y32011XM	55.000 2.1654	90.000 3.5433	23.000 0.9055	23.000 0.9055	17.500 0.6890	1.5 0.06	1.5 0.06	0.57 kg 1.26 lb
X32012X	Y32012X	60.000 2.3622	95.000 3.7402	23.000 0.9055	23.000 0.9055	17.500 0.6890	1.5 0.06	1.5 0.06	0.60 kg 1.32 lb
X32012XM	Y32012XM	60.000 2.3622	95.000 3.7402	23.000 0.9055	23.000 0.9055	17.500 0.6890	1.5 0.06	1.5 0.06	0.59 kg 1.30 lb
X32013X	Y32013X	65.000 2.5591	100.000 3.9370	23.000 0.9055	23.000 0.9055	17.500 0.6890	1.5 0.06	1.5 0.06	0.64 kg 1.41 lb
X32013XM	Y32013XM	65.000 2.5591	100.000 3.9370	23.000 0.9055	23.000 0.9055	17.500 0.6890	1.5 0.06	1.5 0.06	0.63 kg 1.39 lb
XAA32013X	Y32013X	65.000 2.5591	100.000 3.9370	23.000 0.9055	23.000 0.9055	17.500 0.6890	5.0 0.20	1.5 0.06	0.64 kg 1.41 lb
X32014X	Y32014X	70.000 2.7559	110.000 4.3307	25.000 0.9843	25.000 0.9843	19.000 0.7480	1.5 0.06	1.5 0.06	0.87 kg 1.92 lb
X32014XM	Y32014XM	70.000 2.7559	110.000 4.3307	25.000 0.9843	25.000 0.9843	19.000 0.7480	1.5 0.06	1.5 0.06	0.84 kg 1.85 lb
X32015X	Y32015X	75.000 2.9528	115.000 4.5276	25.000 0.9843	25.000 0.9843	19.000 0.7480	1.5 0.06	1.5 0.06	0.92 kg 2.03 lb
X32015XM	Y32015XM	75.000 2.9528	115.000 4.5276	25.000 0.9843	25.000 0.9843	19.000 0.7480	1.5 0.06	1.5 0.06	0.90 kg 1.98 lb
X32016X	Y32016X	80.000 3.1496	125.000 4.9213	29.000 1.1417	29.000 1.1417	22.000 0.8661	1.5 0.06	1.5 0.06	1.28 kg 2.82 lb
X32016XM	Y32016XM	80.000 3.1496	125.000 4.9213	29.000 1.1417	29.000 1.1417	22.000 0.8661	1.5 0.06	1.5 0.06	1.30 kg 2.87 lb
X32017X	Y32017X	85.000 3.3465	130.000 5.1181	29.000 1.1417	29.000 1.1417	22.000 0.8661	1.5 0.06	1.5 0.06	1.35 kg 2.98 lb
X32017XM	Y32017XM	85.000 3.3465	130.000 5.1181	29.000 1.1417	29.000 1.1417	22.000 0.8661	1.5 0.06	1.5 0.06	1.35 kg 2.98 lb
XAA32017X	Y32017X	85.000 3.3465	130.000 5.1181	29.000 1.1417	29.000 1.1417	22.000 0.8661	6.5 0.26	1.5 0.06	1.33 kg 2.94 lb
X32018X	Y32018X	90.000 3.5433	140.000 5.5118	32.000 1.2598	32.000 1.2598	24.000 0.9449	2.0 0.08	1.5 0.06	1.73 kg 3.81 lb
X32018XM	Y32018XM	90.000 3.5433	140.000 5.5118	32.000 1.2598	32.000 1.2598	24.000 0.9449	2.0 0.08	1.5 0.06	1.75 kg 3.86 lb
XAA32018X	Y32018X	90.000 3.5433	140.000 5.5118	32.000 1.2598	32.000 1.2598	24.000 0.9449	6.0 0.24	1.5 0.06	1.73 kg 3.81 lb
XUA32018X	Y32018X	84.000 3.3071	140.000 5.5118	32.000 1.2598	32.000 1.2598	24.000 0.9449	0.5 0.02	1.5 0.06	1.98 kg 4.36 lb
X32019X	Y32019X	95.000 3.7402	145.000 5.7087	32.000 1.2598	32.000 1.2598	24.000 0.9449	2.0 0.08	1.5 0.06	1.80 kg 3.98 lb
X32019XM	Y32019XM	95.000 3.7402	145.000 5.7087	32.000 1.2598	32.000 1.2598	24.000 0.9449	2.0 0.08	1.5 0.06	1.80 kg 3.97 lb
X32020X	Y32020X	100.000 3.9370	150.000 5.9055	32.000 1.2598	32.000 1.2598	24.000 0.9449	2.0 0.08	1.5 0.06	1.90 kg 4.18 lb
X32020XM	Y32020XM	100.000 3.9370	150.000 5.9055	32.000 1.2598	32.000 1.2598	24.000 0.9449	2.0 0.08	1.5 0.06	1.90 kg 4.19 lb
XAA32020X	Y32020X	100.000 3.9370	150.000 5.9055	32.000 1.2598	32.000 1.2598	24.000 0.9449	6.5 0.26	1.5 0.06	1.90 kg 4.18 lb
X32021X	Y32021X	105.000 4.1339	160.000 6.2992	35.000 1.3780	35.000 1.3780	26.000 1.0236	2.5 0.10	2.0 0.08	2.40 kg 5.30 lb
X32021XM	Y32021XM	105.000 4.1339	160.000 6.2992	35.000 1.3780	35.000 1.3780	26.000 1.0236	2.5 0.10	2.0 0.08	2.40 kg 5.29 lb
XGA32021X	Y32021X	106.000 4.1732	160.000 6.2992	35.000 1.3780	35.000 1.3780	26.000 1.0236	6.0 0.24	2.0 0.08	2.36 kg 5.20 lb
X32022X	Y32022X	110.000 4.3307	170.000 6.6929	38.000 1.4961	38.000 1.4961	29.000 1.1417	2.5 0.10	2.0 0.08	3.09 kg 6.82 lb
X32022XM	Y32022XM	110.000 4.3307	170.000 6.6929	38.000 1.4961	38.000 1.4961	29.000 1.1417	2.5 0.10	2.0 0.08	3.05 kg 6.72 lb
X32024X	Y32024X	120.000 4.7244	180.000 7.0866	38.000 1.4961	38.000 1.4961	29.000 1.1417	2.5 0.10	2.0 0.08	3.32 kg 7.31 lb



10

\* Flanged cup, Bearing width is T1 Dimension

**ISOCCLASS BEARINGS**

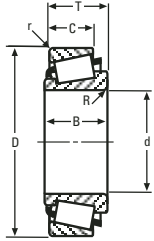

**SINGLE ROW**

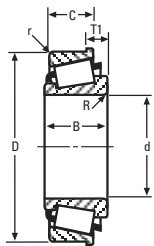

**SINGLE ROW WITH FLANGE**

CONE (Inner Race) number	CUP (Outer Race) number	Cone BORE d	Cup OUTSIDE DIA. D	Bearing WIDTH T	Cone WIDTH B	Cup WIDTH C	Max. Shaft Fillet Radii R	Max. Hsng. Fillet Radii r	Weight
X32024XM	Y32024XM	120.000 4.7244	180.000 7.0866	38.000 1.4961	38.000 1.4961	29.000 1.1417	2.5 0.10	2.0 0.08	3.27 kg 7.22 lb
XAA32024X	Y32024X	120.000 4.7244	180.000 7.0866	38.000 1.4961	38.000 1.4961	29.000 1.1417	5.0 0.20	2.0 0.08	3.25 kg 7.17 lb
X32026X	Y32026X	130.000 5.1181	200.000 7.8740	45.000 1.7717	45.000 1.7717	34.000 1.3386	2.5 0.10	2.0 0.08	5.06 kg 11.15 lb
X32026XM	Y32026XM	130.000 5.1181	200.000 7.8740	45.000 1.7717	45.000 1.7717	34.000 1.3386	2.5 0.10	2.0 0.08	4.96 kg 10.93 lb
X32028X	Y32028X	140.000 5.5118	210.000 8.2677	45.000 1.7717	45.000 1.7717	34.000 1.3386	2.5 0.10	2.0 0.08	5.31 kg 11.71 lb
X32028XM	Y32028XM	140.000 5.5118	210.000 8.2677	45.000 1.7717	45.000 1.7717	34.000 1.3386	2.5 0.10	2.0 0.08	5.24 kg 11.55 lb
X32030X	Y32030X	150.000 5.9055	225.000 8.8583	48.000 1.8898	48.000 1.8898	36.000 1.4173	3.0 0.12	2.5 0.10	6.28 kg 13.85 lb
X32030XM	Y32030XM	150.000 5.9055	225.000 8.8583	48.000 1.8898	48.000 1.8898	36.000 1.4173	3.0 0.12	2.5 0.10	6.38 kg 14.07 lb
X32032XM	Y32032XM	160.000 6.2992	240.000 9.4488	51.000 2.0079	51.000 2.0079	38.000 1.4961	3.0 0.12	2.5 0.10	7.90 kg 17.42 lb
X32034XM	Y32034XM	170.000 6.6929	260.000 10.2362	57.000 2.2441	57.000 2.2441	43.000 1.6929	3.0 0.12	2.5 0.10	10.57 kg 23.31 lb
X32036XM	Y32036XM	180.000 7.0866	280.000 11.0236	64.000 2.5197	64.000 2.5197	48.000 1.8898	3.0 0.12	2.5 0.10	13.94 kg 30.73 lb
X32038XM	Y32038XM	190.000 7.4803	290.000 11.4173	64.000 2.5197	64.000 2.5197	48.000 1.8898	3.0 0.12	2.5 0.10	14.81 kg 32.65 lb
X32040X	Y32040X	200.000 7.8740	310.000 12.2047	70.000 2.7559	70.000 2.7559	53.000 2.0866	3.0 0.12	2.5 0.10	19.50 kg 42.99 lb
X32044X	Y32044X	220.000 8.6614	340.000 13.3858	76.000 2.9921	76.000 2.9921	57.000 2.2441	4.0 0.16	3.0 0.12	25.50 kg 56.22 lb
X32048X	Y32048X	240.000 9.4488	360.000 14.1732	76.000 2.9921	76.000 2.9921	57.000 2.2441	4.0 0.16	3.0 0.12	26.50 kg 58.42 lb
X32048XR	Y32048XR	240.000 9.4488	360.000 14.1732	76.000 2.9921	76.000 2.9921	76.000 2.9921	4.0 0.16	3.0 0.12	25.70 kg 56.66 lb
X32048XRA	Y32048XR	240.000 9.4488	360.000 14.1732	76.000 2.9921	76.000 2.9921	76.000 2.9921	4.0 0.16	3.0 0.12	25.48 kg 56.16 lb
X32064X	Y32064X	320.000 12.5984	480.000 18.8976	100.000 3.9370	100.000 3.9370	74.000 2.9134	5.0 0.20	4.0 0.16	63.00 kg 138.89 lb
X32204	Y32204	20.000 0.7874	47.000 1.8504	19.250 0.7579	18.000 0.7087	15.000 0.5906	1.0 0.04	1.0 0.04	0.16 kg 0.36 lb
X32205	Y32205	25.000 0.9843	52.000 2.0472	19.250 0.7579	18.000 0.7087	15.000 0.5906	1.0 0.04	1.0 0.04	0.18 kg 0.39 lb
X32205B	Y32205B	25.000 0.9843	52.000 2.0472	19.250 0.7579	18.000 0.7087	15.000 0.5906	1.0 0.04	1.0 0.04	0.19 kg 0.42 lb
X32205B	YAA32205B	25.000 0.9843	52.000 2.0472	19.250 0.7579	18.000 0.7087	15.000 0.5906	1.0 0.04	2.0 0.08	0.19 kg 0.42 lb
X32206	Y32206	30.000 1.1811	62.000 2.4409	21.250 0.8366	20.000 0.7874	17.000 0.6693	1.0 0.04	1.0 0.04	0.29 kg 0.63 lb
X32206B	Y32206B	30.000 1.1811	62.000 2.4409	21.250 0.8366	20.000 0.7874	17.000 0.6693	1.0 0.04	1.0 0.04	0.30 kg 0.66 lb
X32206M	Y32206M	30.000 1.1811	62.000 2.4409	21.250 0.8366	20.000 0.7874	17.000 0.6693	1.0 0.04	1.0 0.04	0.28 kg 0.62 lb
X32207	Y32207	35.000 1.3780	72.000 2.8346	24.250 0.9547	23.000 0.9055	19.000 0.7480	1.5 0.06	1.5 0.06	0.44 kg 0.97 lb
X32207B	Y32207B	35.000 1.3780	72.000 2.8346	24.250 0.9547	23.000 0.9055	19.000 0.7480	1.5 0.06	1.5 0.06	0.46 kg 1.02 lb
X32207M	Y32207M	35.000 1.3780	72.000 2.8346	24.250 0.9547	23.000 0.9055	19.000 0.7480	1.5 0.06	1.5 0.06	0.43 kg 0.95 lb
X32208	Y32208	40.000 1.5748	80.000 3.1496	24.750 0.9744	23.000 0.9055	19.000 0.7480	1.5 0.06	1.5 0.06	0.54 kg 1.18 lb
X32208M	Y32208M	40.000 1.5748	80.000 3.1496	24.750 0.9744	23.000 0.9055	19.000 0.7480	1.5 0.06	1.5 0.06	0.52 kg 1.15 lb
X32209	Y32209	45.000 1.7717	85.000 3.3465	24.750 0.9744	23.000 0.9055	19.000 0.7480	1.5 0.06	1.5 0.06	0.59 kg 1.29 lb
X32209M	Y32209M	45.000 1.7717	85.000 3.3465	24.750 0.9744	23.000 0.9055	19.000 0.7480	1.5 0.06	1.5 0.06	0.60 kg 1.33 lb
X32210	Y32210	50.000 1.9685	90.000 3.5433	24.750 0.9744	23.000 0.9055	19.000 0.7480	1.5 0.06	1.5 0.06	0.62 kg 1.37 lb
X32210M	Y32210M	50.000 1.9685	90.000 3.5433	24.750 0.9744	23.000 0.9055	19.000 0.7480	1.5 0.06	1.5 0.06	0.63 kg 1.40 lb

\* Flanged cup, Bearing width is T1 Dimension



ISOCCLASS BEARINGS

CONE (Inner Race) number	CUP (Outer Race) number	Cone BORE d	Cup OUTSIDE DIA. D	Bearing WIDTH T	Cone WIDTH B	Cup WIDTH C	Max. Shaft Fillet Radii R	Max. Hsng. Fillet Radii r	Weight
X32211	Y32211	55.000 2.1654	100.000 3.9370	26.750 1.0531	25.000 0.9843	21.000 0.8268	2.0 0.08	1.5 0.06	0.85 kg 1.87 lb
X32211M	Y32211M	55.000 2.1654	100.000 3.9370	26.750 1.0531	25.000 0.9843	21.000 0.8268	2.0 0.08	1.5 0.06	0.85 kg 1.87 lb
X32211M	*Y32211RM	55.000 2.1654	100.000 3.9370	10.750 0.4232	25.000 0.9843	21.000 0.8268	2.0 0.08	1.5 0.06	0.83 kg 1.83 lb
X32212	Y32212	60.000 2.3622	110.000 4.3307	29.750 1.1713	28.000 1.1024	24.000 0.9449	2.0 0.08	1.5 0.06	1.15 kg 2.54 lb
X32212M	Y32212M	60.000 2.3622	110.000 4.3307	29.750 1.1713	28.000 1.1024	24.000 0.9449	2.0 0.08	1.5 0.06	1.18 kg 2.60 lb
X32213	Y32213	65.000 2.5591	120.000 4.7244	32.750 1.2894	31.000 1.2205	27.000 1.0630	2.0 0.08	1.5 0.06	1.54 kg 3.39 lb
X32213	YAA32213	65.000 2.5591	120.000 4.7244	32.750 1.2894	31.000 1.2205	27.000 1.0630	2.0 0.08	0.8 0.03	1.54 kg 3.39 lb
X32213M	Y32213M	65.000 2.5591	120.000 4.7244	32.750 1.2894	31.000 1.2205	27.000 1.0630	2.0 0.08	1.5 0.06	1.54 kg 3.39 lb
XAA32213	Y32213	65.000 2.5591	120.000 4.7244	32.750 1.2894	31.000 1.2205	27.000 1.0630	2.5 0.10	1.5 0.06	1.54 kg 3.39 lb
XAA32213	YAA32213	65.000 2.5591	120.000 4.7244	32.750 1.2894	31.000 1.2205	27.000 1.0630	2.5 0.10	0.8 0.03	1.54 kg 3.39 lb
X32214	Y32214	70.000 2.7559	125.000 4.9213	33.250 1.3091	31.000 1.2205	27.000 1.0630	2.0 0.08	1.5 0.06	1.64 kg 3.61 lb
X32214M	Y32214M	70.000 2.7559	125.000 4.9213	33.250 1.3091	31.000 1.2205	27.000 1.0630	2.0 0.08	1.5 0.06	1.62 kg 3.58 lb
X32215	Y32215	75.000 2.9528	130.000 5.1181	33.250 1.3091	31.000 1.2205	27.000 1.0630	2.0 0.08	1.5 0.06	1.71 kg 3.76 lb
X32215	*YSA32215R	75.000 2.9528	130.000 5.1181	11.750 0.4626	31.000 1.2205	27.000 1.0630	2.0 0.08	1.5 0.06	1.77 kg 3.90 lb
X32215	*YSB32215R	75.000 2.9528	130.000 5.1181	12.250 0.4823	31.000 1.2205	27.000 1.0630	2.0 0.08	1.5 0.06	1.78 kg 3.92 lb
X32215M	Y32215M	75.000 2.9528	130.000 5.1181	33.250 1.3091	31.000 1.2205	27.000 1.0630	2.0 0.08	1.5 0.06	1.70 kg 3.75 lb
XFA32215	Y32215	60.000 2.3622	130.000 5.1181	33.250 1.3091	31.000 1.2205	27.000 1.0630	0.5 0.02	1.5 0.06	2.09 kg 4.62 lb
XFA32215	*YSA32215R	60.000 2.3622	130.000 5.1181	11.750 0.4626	31.000 1.2205	27.000 1.0630	0.5 0.02	1.5 0.06	2.16 kg 4.76 lb
XFA32215	*YSB32215R	60.000 2.3622	130.000 5.1181	12.250 0.4823	31.000 1.2205	27.000 1.0630	0.5 0.02	1.5 0.06	2.16 kg 4.77 lb
XUA32215	Y32215	75.000 2.9528	130.000 5.1181	47.250 1.8602	45.000 1.7717	27.000 1.0630	1.0 0.04	1.5 0.06	2.00 kg 4.41 lb
XUA32215	*YSA32215R	75.000 2.9528	130.000 5.1181	11.750 0.4626	45.000 1.7717	27.000 1.0630	0.5 0.02	1.5 0.06	2.06 kg 4.55 lb
XUA32215	*YSB32215R	75.000 2.9528	130.000 5.1181	26.250 1.0334	45.000 1.7717	27.000 1.0630	1.0 0.04	1.5 0.06	2.07 kg 4.56 lb
X32216	Y32216	80.000 3.1496	140.000 5.5118	35.250 1.3878	33.000 1.2992	28.000 1.1024	2.5 0.10	2.0 0.08	2.05 kg 4.51 lb
X32216M	Y32216M	80.000 3.1496	140.000 5.5118	35.250 1.3878	33.000 1.2992	28.000 1.1024	2.5 0.10	2.0 0.08	2.10 kg 4.63 lb
X32217	Y32217	85.000 3.3465	150.000 5.9055	38.500 1.5157	36.000 1.4173	30.000 1.1811	2.5 0.10	2.0 0.08	2.64 kg 5.83 lb
X32217M	Y32217M	85.000 3.3465	150.000 5.9055	38.500 1.5157	36.000 1.4173	30.000 1.1811	2.5 0.10	2.0 0.08	2.69 kg 5.93 lb
X32218	Y32218	90.000 3.5433	160.000 6.2992	42.500 1.6732	40.000 1.5748	34.000 1.3386	2.5 0.10	2.0 0.08	3.34 kg 7.37 lb
X32218M	Y32218M	90.000 3.5433	160.000 6.2992	42.500 1.6732	40.000 1.5748	34.000 1.3386	2.5 0.10	2.0 0.08	3.48 kg 7.68 lb
X32219	Y32219	95.000 3.7402	170.000 6.6929	45.500 1.7913	43.000 1.6929	37.000 1.4567	3.0 0.12	2.5 0.10	4.10 kg 9.03 lb
X32219M	Y32219M	95.000 3.7402	170.000 6.6929	45.500 1.7913	43.000 1.6929	37.000 1.4567	3.0 0.12	2.5 0.10	4.26 kg 9.39 lb
X32220	Y32220	100.000 3.9370	180.000 7.0866	49.000 1.9291	46.000 1.8110	39.000 1.5354	3.0 0.12	2.5 0.10	4.97 kg 10.96 lb
X32220M	Y32220M	100.000 3.9370	180.000 7.0866	49.000 1.9291	46.000 1.8110	39.000 1.5354	3.0 0.12	2.5 0.10	5.00 kg 11.02 lb
X32221	Y32221	105.000 4.1339	190.000 7.4803	53.000 2.0866	50.000 1.9685	43.000 1.6929	3.0 0.12	2.5 0.10	6.05 kg 13.34 lb
X32221M	Y32221M	105.000 4.1339	190.000 7.4803	53.000 2.0866	50.000 1.9685	43.000 1.6929	3.0 0.12	2.5 0.10	6.31 kg 13.92 lb
X32222	Y32222	110.000 4.3307	200.000 7.8740	56.000 2.2047	53.000 2.0866	46.000 1.8110	3.0 0.12	2.5 0.10	7.18 kg 15.82 lb

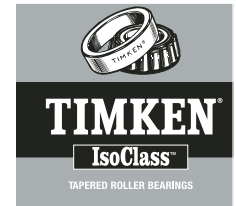

10

\* Flanged cup, Bearing width is T1 Dimension

# ISOCCLASS BEARINGS

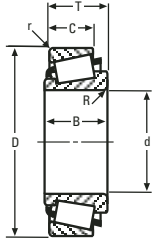

**SINGLE ROW**

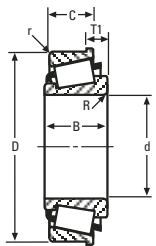

**SINGLE ROW WITH FLANGE**

CONE (Inner Race) number	CUP (Outer Race) number	Cone BORE d	Cup OUTSIDE DIA. D	Bearing WIDTH T	Cone WIDTH B	Cup WIDTH C	Max. Shaft Fillet Radii R	Max. Hsng. Fillet Radii r	Weight
X32222M	Y32222M	110.000 4.3307	200.000 7.8740	56.000 2.2047	53.000 2.0866	46.000 1.8110	3.0 0.12	2.5 0.10	7.28 kg 16.05 lb
X32224	Y32224	120.000 4.7244	215.000 8.4646	61.500 2.4213	58.000 2.2835	50.000 1.9685	3.0 0.12	2.5 0.10	9.03 kg 19.90 lb
X32224M	Y32224M	120.000 4.7244	215.000 8.4646	61.500 2.4213	58.000 2.2835	50.000 1.9685	3.0 0.12	2.5 0.10	9.26 kg 20.43 lb
XFA32224	Y32224	110.000 4.3307	215.000 8.4646	61.500 2.4213	58.000 2.2835	50.000 1.9685	3.0 0.12	2.5 0.10	9.85 kg 21.72 lb
X32226	Y32226	130.000 5.1181	230.000 9.0551	67.750 2.6673	64.000 2.5197	54.000 2.1260	4.1 0.16	3.0 0.12	11.03 kg 24.33 lb
X32226M	Y32226M	130.000 5.1181	230.000 9.0551	67.750 2.6673	64.000 2.5197	54.000 2.1260	4.0 0.16	3.0 0.12	11.56 kg 25.49 lb
X32304	Y32304	20.000 0.7874	52.000 2.0472	22.250 0.8760	21.000 0.8268	18.000 0.7087	1.5 0.06	1.5 0.06	0.24 kg 0.53 lb
X32304M	Y32304M	20.000 0.7874	52.000 2.0472	22.250 0.8760	21.000 0.8268	18.000 0.7087	1.5 0.06	1.5 0.06	0.23 kg 0.51 lb
X32305	Y32305	25.000 0.9843	62.000 2.4409	25.250 0.9941	24.000 0.9449	20.000 0.7874	1.5 0.06	1.5 0.06	0.37 kg 0.82 lb
X32306	Y32306	30.000 1.1811	72.000 2.8346	28.750 1.1319	27.000 1.0630	23.000 0.9055	1.5 0.06	1.5 0.06	0.56 kg 1.24 lb
X32307	Y32307	35.000 1.3780	80.000 3.1496	32.750 1.2894	31.000 1.2205	25.000 0.9843	2.0 0.08	1.5 0.06	0.76 kg 1.68 lb
X32308	Y32308	40.000 1.5748	90.000 3.5433	35.250 1.3878	33.000 1.2992	27.000 1.0630	2.0 0.08	1.5 0.06	1.03 kg 2.28 lb
X32308B	Y32308B	40.000 1.5748	90.000 3.5433	35.250 1.3878	33.000 1.2992	27.000 1.0630	2.0 0.08	1.5 0.06	1.10 kg 2.43 lb
XBA32308B	Y32308B	40.000 1.5748	90.000 3.5433	35.250 1.3878	33.500 1.3189	27.000 1.0630	2.0 0.08	1.5 0.06	1.10 kg 2.43 lb
X32309	Y32309	45.000 1.7717	100.000 3.9370	38.250 1.5059	36.000 1.4173	30.000 1.1811	2.0 0.08	1.5 0.06	1.37 kg 3.03 lb
X32309BM	Y32309BM	45.000 1.7717	100.000 3.9370	38.250 1.5059	36.000 1.4173	30.000 1.1811	2.0 0.08	1.5 0.06	1.45 kg 3.20 lb
X32309M	*Y32309RM	45.000 1.7717	100.000 3.9370	15.250 0.6004	36.000 1.4173	30.000 1.1811	2.0 0.08	1.5 0.06	1.35 kg 2.98 lb
X32309M	Y32309M	45.000 1.7717	100.000 3.9370	38.250 1.5059	36.000 1.4173	30.000 1.1811	2.0 0.08	1.5 0.06	1.42 kg 3.14 lb
X32309BM	*Y32309BRM	45.000 1.7717	100.000 3.9370	15.250 0.6004	36.000 1.4173	30.000 1.1811	2.0 0.08	1.5 0.06	1.45 kg 3.20 lb
X32310	Y32310	50.000 1.9685	110.000 4.3307	42.250 1.6634	40.000 1.5748	33.000 1.2992	2.5 0.10	2.0 0.08	1.84 kg 4.06 lb
X32310B	Y32310B	50.000 1.9685	110.000 4.3307	42.250 1.6634	40.000 1.5748	33.000 1.2992	2.5 0.10	2.0 0.08	1.95 kg 4.29 lb
X32311	Y32311	55.000 2.1654	120.000 4.7244	45.500 1.7913	43.000 1.6929	35.000 1.3780	2.5 0.10	2.0 0.08	2.34 kg 5.17 lb
X32311BM	Y32311BM	55.000 2.1654	120.000 4.7244	45.500 1.7913	43.000 1.6929	35.000 1.3780	2.5 0.10	2.0 0.08	2.50 kg 5.51 lb
X32311M	*Y32311RM	55.000 2.1654	120.000 4.7244	18.500 0.7283	43.000 1.6929	35.000 1.3780	2.5 0.10	2.0 0.08	2.30 kg 5.07 lb
X32311M	Y32311M	55.000 2.1654	120.000 4.7244	45.500 1.7913	43.000 1.6929	35.000 1.3780	2.5 0.10	2.0 0.08	2.36 kg 5.20 lb
X32311BM	*Y32311BRM	55.000 2.1654	120.000 4.7244	18.500 0.7283	43.000 1.6929	35.000 1.3780	2.5 0.10	2.0 0.08	2.50 kg 5.51 lb
X32312	Y32312	60.000 2.3622	130.000 5.1181	48.500 1.9094	46.000 1.8110	37.000 1.4567	3.0 0.12	2.5 0.10	2.90 kg 6.39 lb
X32312B	Y32312B	60.000 2.3622	130.000 5.1181	48.500 1.9094	46.000 1.8110	37.000 1.4567	3.0 0.12	2.5 0.10	3.10 kg 6.84 lb
X32312MB	Y32312BM	60.000 2.3622	130.000 5.1181	48.500 1.9094	46.000 1.8110	37.000 1.4567	3.0 0.12	2.5 0.10	2.80 kg 6.17 lb
X32312BM	*Y32312BRM	60.000 2.3622	130.000 5.1181	19.500 0.7677	46.000 1.8110	37.000 1.4567	3.0 0.12	2.5 0.10	2.80 kg 6.17 lb
X32313	Y32313	65.000 2.5591	140.000 5.5118	51.000 2.0079	48.000 1.8898	39.000 1.5354	3.0 0.12	2.5 0.10	3.54 kg 7.81 lb
X32313M	Y32313M	65.000 2.5591	140.000 5.5118	51.000 2.0079	48.000 1.8898	39.000 1.5354	3.0 0.12	2.5 0.10	3.63 kg 8.01 lb
X32314	Y32314	70.000 2.7559	150.000 5.9055	54.000 2.1260	51.000 2.0079	42.000 1.6535	3.0 0.12	2.5 0.10	4.29 kg 9.45 lb
X32314M	Y32314M	70.000 2.7559	150.000 5.9055	54.000 2.1260	51.000 2.0079	42.000 1.6535	3.0 0.12	2.5 0.10	4.40 kg 9.71 lb

\* Flanged cup, Bearing width is T1 Dimension

10

ISOCCLASS BEARINGS

CONE (Inner Race) number	CUP (Outer Race) number	Cone BORE d	Cup OUTSIDE DIA. D	Bearing WIDTH T	Cone WIDTH B	Cup WIDTH C	Max. Shaft Fillet Radii R	Max. Hsng. Fillet Radii r	Weight
X32316	Y32316	80.000 3.1496	170.000 6.6929	61.500 2.4213	58.000 2.2835	48.000 1.8898	3.0 0.12	2.5 0.1	6.32 kg 13.94 lb
X32316M	Y32316M	80.000 3.1496	170.000 6.6929	61.500 2.4213	58.000 2.2835	48.000 1.8898	3.0 0.12	2.5 0.10	6.35 kg 13.99 lb
X32317	Y32317	85.000 3.3465	180.000 7.0866	63.500 2.5000	60.000 2.3622	49.000 1.9291	4.0 0.16	3.0 0.12	7.27 kg 16.04 lb
X32924	Y32924	120.000 4.7244	165.000 6.4961	29.000 1.1417	29.000 1.1417	23.000 0.9055	15.0 0.59	15.0 0.59	1.78 kg 3.92 lb
X32924M	Y32924M	120.000 4.7244	165.000 6.4961	29.000 1.1417	29.000 1.1417	23.000 0.9055	1.5 0.06	1.5 0.06	1.80 kg 3.96 lb
X32928M	Y32928M	140.000 5.5118	190.000 7.4803	32.000 1.2598	32.000 1.2598	25.000 0.9843	2.0 0.08	1.5 0.06	2.52 kg 5.56 lb
X32930M	Y32930M	150.000 5.9055	210.000 8.2677	38.000 1.4961	38.000 1.4961	30.000 1.1811	2.5 0.10	2.0 0.08	4.00 kg 8.81 lb
X32934M	Y32934M	170.000 6.6929	230.000 9.0551	38.000 1.4961	38.000 1.4961	30.000 1.1811	2.5 0.10	2.0 0.08	4.41 kg 9.72 lb
X32936	Y32936	180.000 7.0866	250.000 9.8425	45.000 1.7717	45.000 1.7717	34.000 1.3386	2.5 0.10	2.0 0.08	6.51 kg 14.34 lb
X32936M	Y32936M	180.000 7.0866	250.000 9.8425	45.000 1.7717	45.000 1.7717	34.000 1.3386	2.5 0.10	2.0 0.08	6.50 kg 14.33 lb
X32940M	Y32940M	200.000 7.8740	280.000 11.0236	51.000 2.0079	51.000 2.0079	39.000 1.5354	3.0 0.12	2.5 0.10	9.44 kg 20.82 lb
X32944	Y32944	220.000 8.6614	300.000 11.8110	51.000 2.0079	51.000 2.0079	39.000 1.5354	3.0 0.12	2.5 0.10	11.20 kg 24.69 lb
X32960	Y32960	300.000 11.8110	420.000 16.5354	76.000 2.9921	76.000 2.9921	56.000 2.2047	4.0 0.16	4.0 0.16	31.50 kg 69.45 lb
X32972	Y32972	360.000 14.1732	480.000 18.8976	76.500 3.0118	76.500 3.0118	72.000 2.8346	4.0 0.16	3.0 0.12	40.60 kg 89.51 lb
X33010	Y33010	50.000 1.9685	80.000 3.1496	24.000 0.9449	24.000 0.9449	19.000 0.7480	1.0 0.04	1.0 0.04	0.45 kg 1.00 lb
XAA33010	Y33010	50.000 1.9685	80.000 3.1496	24.000 0.9449	24.000 0.9449	19.000 0.7480	1.5 0.06	1.0 0.04	0.45 kg 1.00 lb
X33011	Y33011	55.000 2.1654	90.000 3.5433	27.000 1.0630	27.000 1.0630	21.000 0.8268	1.5 0.06	1.5 0.06	0.67 kg 1.47 lb
X33012	Y33012	60.000 2.3622	95.000 3.7402	27.000 1.0630	27.000 1.0630	21.000 0.8268	1.5 0.06	1.5 0.06	0.70 kg 1.54 lb
X33013	Y33013	65.000 2.5591	100.000 3.9370	27.000 1.0630	27.000 1.0630	21.000 0.8268	1.5 0.06	1.5 0.06	0.75 kg 1.65 lb
X33014M	Y33014M	70.000 2.7559	110.000 4.3307	31.000 1.2205	31.000 1.2205	25.500 1.0039	1.5 0.06	1.5 0.06	1.11 kg 2.44 lb
X33015	Y33015	75.000 2.9528	115.000 4.5276	31.000 1.2205	31.000 1.2205	25.500 1.0039	1.5 0.06	1.5 0.06	1.16 kg 2.56 lb
X33017	Y33017	85.000 3.3465	130.000 5.1181	36.000 1.4173	36.000 1.4173	29.500 1.1614	1.5 0.06	1.5 0.06	1.75 kg 3.86 lb
X33018	Y33018	90.000 3.5433	140.000 5.5118	39.000 1.5354	39.000 1.5354	32.500 1.2795	2.0 0.08	1.5 0.06	2.20 kg 4.85 lb
X33019	Y33019	95.000 3.7402	145.000 5.7087	39.000 1.5354	39.000 1.5354	32.500 1.2795	2.0 0.08	1.5 0.06	2.25 kg 4.96 lb
XAA33019	Y33019	95.000 3.7402	145.000 5.7087	39.000 1.5354	39.000 1.5354	32.500 1.2795	6.0 0.24	1.5 0.06	2.25 kg 4.96 lb
X33020	Y33020	100.000 3.9370	150.000 5.9055	39.000 1.5354	39.000 1.5354	32.500 1.2795	2.0 0.08	1.5 0.06	2.37 kg 5.22 lb
X33021	Y33021	105.000 4.1339	160.000 6.2992	43.000 1.6929	43.000 1.6929	34.000 1.3386	2.5 0.10	2.0 0.08	2.97 kg 6.55 lb
X33021M	Y33021M	105.000 4.1339	160.000 6.2992	43.000 1.6929	43.000 1.6929	34.000 1.3386	2.5 0.10	2.0 0.08	2.98 kg 6.57 lb
X33022	Y33022	110.000 4.3307	170.000 6.6929	47.000 1.8504	47.000 1.8504	37.000 1.4567	2.5 0.10	2.0 0.08	3.84 kg 8.47 lb
X33024	Y33024	120.000 4.7244	180.000 7.0866	48.000 1.8898	48.000 1.8898	38.000 1.4961	2.5 0.10	2.0 0.08	4.20 kg 9.26 lb
X33108	Y33108	40.000 1.5748	75.000 2.9528	26.000 1.0236	26.000 1.0236	20.500 0.8071	1.5 0.06	1.5 0.06	0.50 kg 1.10 lb
XAA33108	Y33108	40.000 1.5748	75.000 2.9528	26.000 1.0236	26.000 1.0236	20.500 0.8071	3.5 0.14	1.5 0.06	0.50 kg 1.10 lb

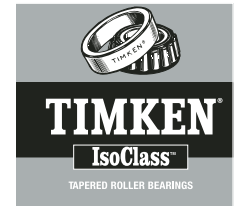

10

\* Flanged cup, Bearing width is T1 Dimension

# ISOCCLASS BEARINGS

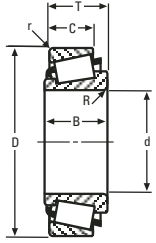

**SINGLE ROW**

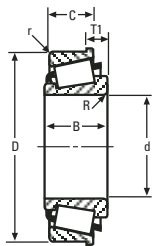

**SINGLE ROW WITH FLANGE**

CONE (Inner Race) number	CUP (Outer Race) number	Cone BORE d	Cup OUTSIDE DIA. D	Bearing WIDTH T	Cone WIDTH B	Cup WIDTH C	Max. Shaft Fillet Radii R	Max. Hsng. Fillet Radii r	Weight
X33109	Y33109	45.000 1.7717	80.000 3.1496	26.000 1.0236	26.000 1.0236	20.500 0.8071	1.5 0.06	1.5 0.06	0.53 kg 1.18 lb
X33109	*Y33109R	45.000 1.7717	80.000 3.1496	10.000 0.3937	26.000 1.0236	20.500 0.8071	1.5 0.06	1.5 0.06	0.56 kg 1.23 lb
X33110	Y33110	50.000 1.9685	85.000 3.3465	26.000 1.0236	26.000 1.0236	20.000 0.7874	1.5 0.06	1.5 0.06	0.59 kg 1.30 lb
X33111	Y33111	55.000 2.1654	95.000 3.7402	30.000 1.1811	30.000 1.1811	23.000 0.9055	1.5 0.06	1.5 0.06	0.85 kg 1.87 lb
XAA33111	Y33111	55.000 2.1654	95.000 3.7402	30.000 1.1811	30.000 1.1811	23.000 0.9055	3.5 0.14	1.5 0.06	0.85 kg 1.87 lb
X33112	Y33112	60.000 2.3622	100.000 3.9370	30.000 1.1811	30.000 1.1811	23.000 0.9055	1.5 0.06	1.5 0.06	0.91 kg 2.01 lb
X33113	Y33113	65.000 2.5591	110.000 4.3307	34.000 1.3386	34.000 1.3386	26.500 1.0433	1.5 0.06	1.5 0.06	1.25 kg 2.76 lb
X33114	Y33114	70.000 2.7559	120.000 4.7244	37.000 1.4567	37.000 1.4567	29.000 1.1417	2.0 0.08	1.5 0.06	1.68 kg 3.70 lb
X33115	Y33115	75.000 2.9528	125.000 4.9213	37.000 1.4567	37.000 1.4567	29.000 1.1417	2.0 0.08	1.5 0.06	1.77 kg 3.91 lb
XAA33115	Y33115	75.000 2.9528	125.000 4.9213	37.000 1.4567	37.000 1.4567	29.000 1.1417	6.0 0.24	1.5 0.06	1.77 kg 3.91 lb
X33116	Y33116	80.000 3.1496	130.000 5.1181	37.000 1.4567	37.000 1.4567	29.000 1.1417	2.0 0.08	1.5 0.06	1.88 kg 4.14 lb
X33116M	Y33116M	80.000 3.1496	130.000 5.1181	37.000 1.4567	37.000 1.4567	29.000 1.1417	2.0 0.08	1.5 0.06	1.87 kg 4.13 lb
X33117	Y33117	85.000 3.3465	140.000 5.5118	41.000 1.6142	41.000 1.6142	32.000 1.2598	2.5 0.10	2.0 0.08	2.48 kg 5.48 lb
X33118	Y33118	90.000 3.5433	150.000 5.9055	45.000 1.7717	45.000 1.7717	35.000 1.3780	2.5 0.10	2.0 0.08	3.17 kg 6.99 lb
X33118M	Y33118M	90.000 3.5433	150.000 5.9055	45.000 1.7717	45.000 1.7717	35.000 1.3780	2.5 0.10	2.0 0.08	3.13 kg 6.89 lb
X33205	Y33205	25.000 0.9843	52.000 2.0472	22.000 0.8661	22.000 0.8661	18.000 0.7087	1.0 0.04	1.0 0.04	0.22 kg 0.50 lb
X33206	Y33206	30.000 1.1811	62.000 2.4409	25.000 0.9843	25.000 0.9843	19.500 0.7677	1.0 0.04	1.0 0.04	0.35 kg 0.78 lb
X33207	Y33207	35.000 1.3780	72.000 2.8346	28.000 1.1024	28.000 1.1024	22.000 0.8661	1.5 0.06	1.5 0.06	0.53 kg 1.18 lb
X33208	Y33208	40.000 1.5748	80.000 3.1496	32.000 1.2598	32.000 1.2598	25.000 0.9843	1.5 0.06	1.5 0.06	0.73 kg 1.62 lb
X33209	Y33209	45.000 1.7717	85.000 3.3465	32.000 1.2598	32.000 1.2598	25.000 0.9843	1.5 0.06	1.5 0.06	0.79 kg 1.75 lb
X33210	Y33210	50.000 1.9685	90.000 3.5433	32.000 1.2598	32.000 1.2598	24.500 0.9646	1.5 0.06	1.5 0.06	0.85 kg 1.87 lb
X33210	*YSA33210R	50.000 1.9685	95.000 3.7402	10.000 0.3936	32.000 1.2598	27.000 1.0630	1.5 0.06	1.5 0.06	1.05 kg 2.32 lb
XGA33210	Y33210	40.000 1.5748	90.000 3.5433	32.000 1.2598	32.000 1.2598	24.500 0.9646	1.5 0.06	1.5 0.06	1.03 kg 2.26 lb
XGA33210	*YSA33210R	40.000 1.5748	95.000 3.7402	10.000 0.3937	32.000 1.2598	27.000 1.0630	1.5 0.06	1.5 0.06	1.23 kg 2.71 lb
X33211	Y33211	55.000 2.1654	100.000 3.9370	35.000 1.3780	35.000 1.3780	27.000 1.0630	2.0 0.08	1.5 0.06	1.17 kg 2.57 lb
X33211M	Y33211M	55.000 2.1654	100.000 3.9370	35.000 1.3780	35.000 1.3780	27.000 1.0630	2.0 0.08	1.5 0.06	1.20 kg 2.65 lb
XGA33211	Y33211	50.815 2.0006	100.000 3.9370	35.000 1.3780	35.000 1.3780	27.000 1.0630	2.0 0.08	1.5 0.06	1.26 kg 2.78 lb
XLA33211	Y33211	50.000 1.9685	100.000 3.9370	33.500 1.3189	33.500 1.3189	27.000 1.0630	2.0 0.08	1.5 0.06	1.25 kg 2.75 lb
X33212	Y33212	60.000 2.3622	110.000 4.3307	38.000 1.4961	38.000 1.4961	29.000 1.1417	2.0 0.08	1.5 0.06	1.53 kg 3.37 lb
X33212	*Y33212R	60.000 2.3622	110.000 4.3307	16.000 0.6299	38.000 1.4961	29.000 1.1417	2.0 0.08	1.5 0.06	1.59 kg 3.50 lb
XAA33212	Y33212	60.000 2.3622	110.000 4.3307	38.000 1.4961	38.000 1.4961	29.000 1.1417	6.0 0.24	1.5 0.06	1.53 kg 3.37 lb
XAA33212	*Y33212R	60.000 2.3622	110.000 4.3307	16.000 0.6299	28.000 1.1024	29.000 1.1417	6.0 0.24	1.5 0.06	1.59 kg 3.50 lb
XAB33212	Y33212	60.000 2.3622	110.000 4.3307	38.000 1.4961	38.000 1.4961	29.000 1.1417	5.0 0.20	1.5 0.06	1.53 kg 3.37 lb

\* Flanged cup, Bearing width is T1 Dimension

**ISOCCLASS BEARINGS**

CONE (Inner Race) number	CUP (Outer Race) number	Cone BORE d	Cup OUTSIDE DIA. D	Bearing WIDTH T	Cone WIDTH B	Cup WIDTH C	Max. Shaft Fillet Radii R	Max. Hsng. Fillet Radii r	Weight
XAB33212	*Y33212R	60.000	110.000	16.000	38.000	29.000	5.0	1.5	1.59 kg
		2.3622	4.3307	0.6299	1.4961	1.1417	0.20	0.06	3.50 lb
XGA33212	Y33212	45.000	110.000	38.000	38.000	29.000	3.5	1.5	1.89 kg
		1.7717	4.3307	1.4961	1.4961	1.1417	0.14	0.06	4.17 lb
XGA33212	*Y33212R	45.000	110.000	16.000	38.000	29.000	3.5	1.5	1.95 kg
		1.7717	4.3307	0.6299	1.4961	1.1417	0.14	0.06	4.30 lb
XGB33212	Y33212	55.000	110.000	38.000	38.000	29.000	0.8	1.5	1.67 kg
		2.1654	4.3307	1.4961	1.4961	1.1417	0.03	0.06	3.67 lb
XGB33212	*Y33212R	55.000	110.000	16.000	38.000	29.000	0.8	1.5	1.72 kg
		2.1654	4.3307	0.6299	1.4961	1.1417	0.03	0.06	3.80 lb
X33213	Y33213	65.000	120.000	41.000	41.000	32.000	2.0	1.5	1.97 kg
		2.5591	4.7244	1.6142	1.6142	1.2598	0.08	0.06	4.35 lb
X33213M	Y33213M	65.000	120.000	41.000	41.000	32.000	2.0	1.5	1.99 kg
		2.5591	4.7244	1.6142	1.6142	1.2598	0.08	0.06	4.39 lb
X33214	Y33214	70.000	125.000	41.000	41.000	32.000	2.0	1.5	2.11 kg
		2.7559	4.9213	1.6142	1.6142	1.2598	0.08	0.06	4.66 lb
X33215	Y33215	75.000	130.000	41.000	41.000	32.000	2.0	1.5	2.18 kg
		2.9528	5.1181	1.6142	1.6142	1.2598	0.08	0.06	4.81 lb
X33215M	Y33215M	75.000	130.000	41.000	41.000	32.000	2.0	1.5	2.25 kg
		2.9528	5.1181	1.6142	1.6142	1.2598	0.08	0.06	4.96 lb
X33216	Y33216	80.000	140.000	46.000	46.000	35.000	2.5	2.0	2.94 kg
		3.1496	5.5118	1.8110	1.8110	1.3780	0.10	0.08	6.49 lb
X33217	Y33217	85.000	150.000	49.000	49.000	37.000	2.5	2.0	3.61 kg
		3.3465	5.9055	1.9291	1.9291	1.4567	0.10	0.08	7.96 lb
X33217M	Y33217M	85.000	150.000	49.000	49.000	37.000	2.5	2.0	3.70 kg
		3.3465	5.9055	1.9291	1.9291	1.4567	0.10	0.08	8.16 lb



**10**

\* Flanged cup, Bearing width is T1 Dimension

**UNIT BEARING™ – TSU TYPE BEARING**

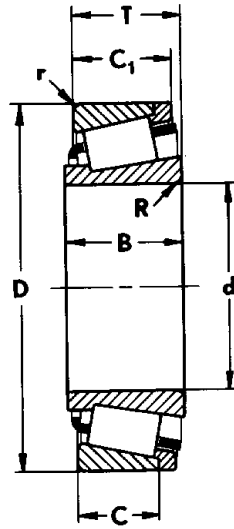

CONE			MAX SHAFT FILLET RADII R	CUP			WIDTH OVER RIB RING AND CUP C1	MAX HS'NG FILLET RADII r''	BEARING	Remarks
SERIES	BORE d	WIDTH B		Number	OUTSIDE DIA D	WIDTH c			WIDTH T	
U100	U199	29.987	19.500	U160L	58.000	13.000	16.000	1.3	17.000	
		1.1811	0.7677		2.3	2.8750				
U200	U298	34.987	20.600	U261L	65.000	14.000	17.000	1.3	16.100	
		1.3780	0.8110		2.3	2.5591				
U300	U399	39.688	22.098	U360L	73.025	15.265	18.500	1.3	19.395	
		1.5625	0.8700		2.3	2.8750				
	U399A	39.688	22.098	U365L	79.967	15.265	20.091	1.3	19.395	
		1.5625	0.8700		3.1483	0.6010	0.7910	0.05	0.7636	
U400	U497	44.987	26.000	U460L	79.975	18.000	22.000	1.3	24.000	
		1.7717	1.0236		3.1496	0.7087	0.8622	0.05	0.9449	

DUO-FACE® SERIES CONTINUED ON NEXT PAGE

\*\*These Maximum Fillet Radii will be cleared by the Cone or Cup Radii.  
\*See Remarks Column.

11

DUO-FACE® – TSL BEARING TYPE

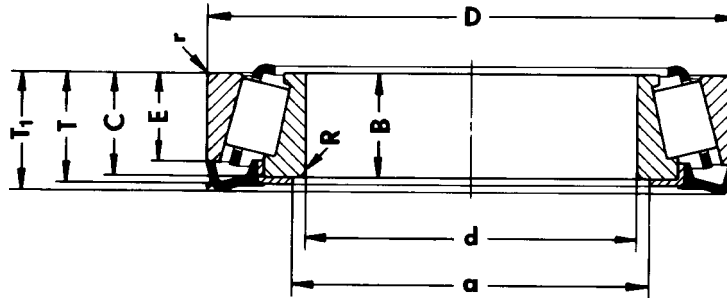

CONE			MAX SHAFT FILLET RADII R''	CUP			MAX HS'NG FILLET RADII r''	SEAL		BEARING			Remarks
Number	BORE d	WIDTH B		Number	OUTSIDE DIA D	WIDTH C		Number	INSIDE DIA a	NORMAL WIDTH C	OVER STAMP WIDTH T	OVER SEAL WIDTH T1	
<b>395 SERIES</b>													
390A	68.262 2.6875	21.996 0.8660	2.3 0.09	394A	110.000 4.3307	18.824 0.7411	1.3 0.05	395LC	73.660 2.9000	22.000 0.8661	23.218 0.9141	24.638 0.9700	
399A	68.262 2.6875	21.996 0.8660	2.3 0.09	394A	110.000 4.3307	18.824 0.7411	1.3 0.05	395LA	73.660 2.9000	22.000 0.8661	23.218 0.9141	24.638 0.9700	
<b>07000 SERIES</b>													
07100	25.400 1.0000	14.260 0.5614	1.0 0.04	07196	50.005 1.9687	9.525 0.3750	0.4 0.02	07000LA	27.940 1.1000	13.495 0.5313	14.206 0.5593	15.392 0.6060	
<b>LM11900 SERIES</b>													
LM11949	19.050 0.7500	16.637 0.6550	0.4 0.015	LM11910	45.237 1.7810	12.065 0.4750	1.3 0.05	LM11900EA	27.000 1.0630	15.494 0.6100	16.281 0.6410	17.400 0.6850	
LM11949	19.050 0.7500	16.637 0.6550	0.4 0.015	LM11910	45.237 1.7810	12.065 0.4750	1.3 0.05	LM11900LA	22.225 0.8750	15.494 0.6100	16.281 0.6410	17.400 0.6850	
<b>M12600 SERIES</b>													
M12649	21.430 0.8437	18.288 0.7200	1.3 0.05	M12610	50.005 1.9687	13.970 0.5500	1.3 0.05	M12600LA	24.511 0.9650	0.690 17.5260	0.721 18.3130	19.430 0.7650	
<b>13600 SERIES</b>													
13685	38.100 1.5000	19.050 0.7500	3.5 0.14	13621	69.012 2.7170	15.083 0.5938	2.3 0.09	13600LA	45.974 1.8100	19.050 0.7500	19.812 0.7800	20.960 0.8250	
13685	38.100 1.5000	19.050 0.7500	3.5 0.14	13621A	69.012 2.7170	14.321 0.5638	2.3 0.09	13600LA	45.974 1.8100	19.050 0.7500	19.812 0.7800	20.960 0.8250	
<b>LM29700 SERIES</b>													
LM29748	38.100 1.5000	18.288 0.7200	0.3 0.01	LM29710	65.068 2.5625	13.970 0.4200	1.3 0.05	LM29700LA	45.847 1.8050	18.034 0.7100	18.796 0.7400	19.940 0.7850	
<b>L44600 SERIES</b>													
L44642	25.400 1.0000	14.732 0.5800	3.5 0.14	L44610	50.292 1.9800	10.668 0.4200	1.3 0.05	L44600LC	34.925 1.3750	14.224 0.5600	14.935 0.5880	16.130 0.6350	
L44643	25.400 1.0000	14.732 0.5800	1.3 0.05	L44610	50.292 1.9800	10.668 0.4200	1.3 0.05	L44600LA	34.925 1.3750	14.224 0.5600	14.935 0.5880	16.130 0.6350	
L44643X	25.400 1.0000	14.732 0.5800	1.3 0.05	L44610	50.292 1.9800	10.668 0.4200	1.3 0.05	L44600LB	34.925 1.3750	14.224 0.5600	14.935 0.5880	16.130 0.6350	With O-Ring K97154 in Bore
<b>LM48500 SERIES</b>													
LM48548	34.925 1.3750	18.288 0.7200	0.4 0.015	LM48510	65.088 2.5625	13.970 0.5500	1.3 0.05	LM48500LA	42.799 1.6850	18.034 0.7100	18.796 0.7400	19.940 0.7850	
<b>LM67000 SERIES</b>													
LM67048	31.750 1.2500	16.764 0.6600	0.4 0.015	LM67010	59.131 2.3280	11.811 0.4650	1.3 0.05	LM67000LA	39.599 1.5590	15.875 0.6250	16.637 0.6550	17.780 0.7000	

11

\*\*These Maximum Fillet Radii will be cleared by the Cone or Cup Radii.  
\*See Remarks Column.

# MULTIPLE-ROW STEERING GEAR BEARING

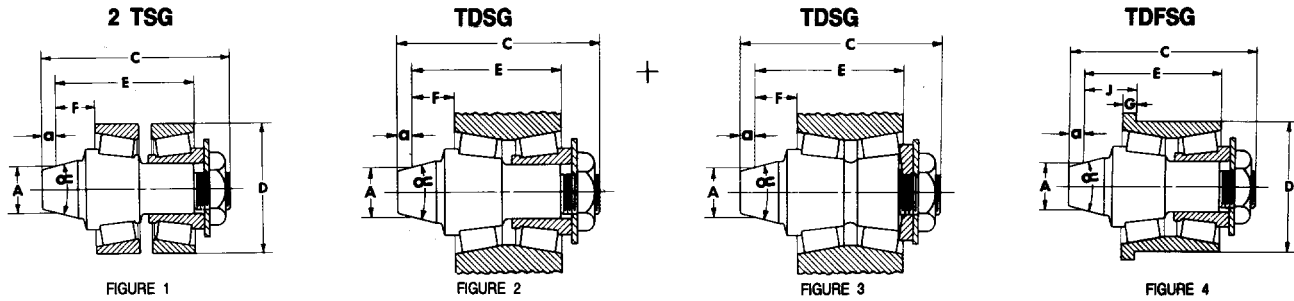

BEARING NUMBER	FIG. NO.	CONTACT DIAMETER	a	NOSE ANGLE	CUP OUTSIDE DIAMETER D	WIDTH C	E	STANDOUT	FLANGE WIDTH C	REMARKS
		A						F OR J		
A3045 - A3044	2	12.471	2.54	29°-0'	-	42.469	30.002	9.365	-	
	2	0.4910	0.100	29°-0'	-	1.6720	1.1812	0.3687	-	
00053 - 00055	2	16.027	2.54	29°-0'	-	49.566	36.312	12.141	-	
	2	0.6310	0.100	29°-0'	-	1.9514	1.4296	0.4780	-	
00053 - 00055 - 00152	1	16.027	2.54	29°-0'	38.100	49.566	39.307	9.147	-	
	1	0.6310	0.100	29°-0'	1.5000	1.9514	1.5475	0.3601	-	
00057 - 00055	2	12.471	2.54	29°-0'	-	47.584	34.331	10.160	-	
	2	0.4910	0.100	29°-0'	-	1.8734	1.3516	0.4000	-	
00057 - 00055 - 00152	1	12.471	2.54	29°-0'	38.100	47.584	37.325	7.165	-	
	1	0.4910	0.100	29°-0'	1.5000	1.8734	1.4695	0.2621	-	
00058 - 00055 - 00153DB	4	13.208	2.54	29°-0'	38.100	49.987	37.135	14.910	3.175	
	4	0.5200	0.100	29°-0'	1.5000	1.9680	1.4620	0.5870	0.1250	
09083 - 09079 - 09195DB	4	14.453	2.54	29°-0'	49.225	65.088	48.710	21.130	3.970	
	4	0.5690	0.100	29°-0'	1.9380	2.5625	1.9177	0.8319	0.1583	
M12430 - M12448 - M12411DB	4	14.453	2.54	29°-0'	49.225	57.900	43.467	20.447	3.967	
	4	0.5690	0.100	29°-0'	1.9380	2.2795	1.7113	0.8055	0.1562	
M12431 - M12448 - M12411DB	4	10.389	2.54	40°-0'	49.225	58.687	44.254	21.234	3.967	
	4	0.4090	0.100	40°-0'	1.9380	2.3105	1.7423	0.8360	0.1562	
17482 - 17481 - 17420DB	4	13.208	2.54	29°-0'	39.688	50.394	37.135	14.910	3.175	
	4	0.5200	0.100	29°-0'	1.5625	1.9840	1.4620	0.5870	0.1250	
17483 - 17481 - 17420DB	4	11.938	2.54	29°-0'	39.688	50.394	37.135	14.910	3.175	
	4	0.4700	0.100	29°-0'	1.5625	1.9840	1.4620	0.5870	0.1250	
17484 - 17481 - 17420DB	4	11.938	6.81	29°-0'	39.688	54.661	37.135	14.910	3.175	
	4	0.4700	0.268	29°-0'	1.5625	2.1520	1.4620	0.5870	0.1250	
17485 - 17481 - 17420DB	4	8.763	2.54	40°-0'	39.688	51.232	37.973	15.748	3.175	
	4	0.3450	0.100	40°-0'	1.5625	2.0170	1.4950	0.6200	0.1250	
17486 - 17481 - 17420DB	4	10.973	2.54	40°-0'	39.688	52.502	39.243	17.018	3.175	
	4	0.4320	0.100	40°-0'	1.5625	2.0670	1.5450	0.6700	0.1250	
17582 - 17581 - 17520DB	4	14.453	2.54	29°-0'	42.863	51.595	38.722	14.910	3.175	
	4	0.5690	0.100	29°-0'	1.6875	2.0313	1.5245	0.5870	0.1250	
17583 - 17581 - 17520DB	4	14.453	2.54	29°-0'	42.863	55.557	42.685	18.872	3.175	
	4	0.5690	0.100	29°-0'	1.6875	2.1873	1.6805	0.7430	0.1250	
17584 - 17581 - 17520DB	4	8.763	2.54	40°-0'	42.863	55.481	42.609	18.796	3.175	
	4	0.3450	0.100	40°-0'	1.6875	2.1843	1.6775	0.7400	0.1250	
LM31331	3	8.458	3.68	40°-0'	-	47.473	31.814	11.176	-	
	3	0.3330	0.145	40°-0'	-	1.8690	1.2525	0.4400	-	
LM31333	3	11.113	3.68	29°-0'	-	47.473	31.814	11.176	-	
	3	0.4375	0.145	29°-0'	-	1.8690	1.2525	0.4400	-	

STEERING GEAR SERIES CONTINUED ON NEXT PAGE

11



STEERING GEAR BEARING – TYPE TSG

BA CONSTRUCTION

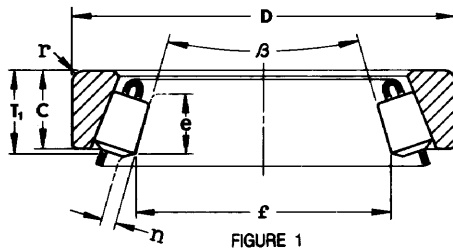

BC CONSTRUCTION

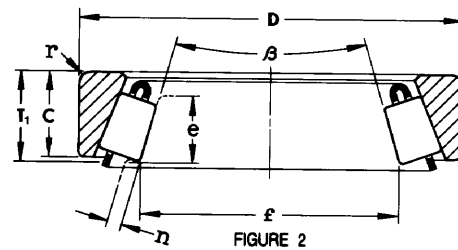

CAGE AND ROLLER						CUP			MAX. HOUSING FILLET RADIUS r	BA CONST. WIDTH		REMARKS	
NUMBER	FIG. NO.	BASE DIA f	RACE LENGTH e	RIB HEIGHT n	CONE ANGLE	Number	OUTSIDE DIA. D	WIDTH C		T1	T1		
<b>5 SERIES</b>													
5BA	1	28.070	7.315	1.905	25°-24'	6	44.450	9.525	1.5	9.525	10.063	6C: SPECIAL BACKFACE CHAMFER  7A: STEPPED OD	
	1	1.1051	0.2880	0.0750	25°-24'		1.7500	0.3750	0.06	0.3750	0.3962		
5BC	2	28.313	7.854	1.727	25°-24'	*6C	49.146	19.050	CH	18.931	19.469		
	2	1.1147	0.3092	0.0680	25°-24'	1.9349	0.7500	CH	0.7453	0.7665			
						7	49.154	15.088	0.5	15.088	15.626		
							1.9352	0.5940	0.02	0.5940	0.6152		
						*7A	49.154	22.225	0.8	22.205	22.746		
							1.9352	0.8750	0.03	0.8742	0.8955		
						06	49.154	15.875	0.8	15.794	16.332		
							1.9352	0.6250	0.03	0.6218	0.6430		
<b>11 SERIES</b>													
11BA	1	33.010	7.610	1.981	29°-58'	13C	49.225	11.509	1.5	12.311	12.845		14: BACKFACE CHAMFER  14C: SPECIAL BACKFACE CHAMFER
	1	1.2996	0.2996	0.0780	29°-58'		1.9380	0.4531	0.06	0.4847	0.5057		
11BC	2	33.297	8.123	1.727	29°-58'	13X	49.609	11.509	1.5	12.311	12.845		
	2	1.3109	0.3198	0.0680	29°-58'		1.9531	0.4531	0.06	0.4847	0.5057		
						*14	53.917	16.172	CH	17.323	17.859		
							2.1227	0.6367	CH	0.6820	0.7031		
						*14C	57.092	17.094	CH	17.920	18.456		
							2.2477	0.6730	CH	0.7055	0.7266		
						14CE	52.362	9.525	1.5	9.530	10.063		
							2.0615	0.3750	0.06	0.3752	0.3962		
						14XS	57.092	17.094	2.0	17.922	18.456		
							2.2477	0.6730	0.08	0.7056	0.7266		
<b>15 SERIES</b>													
15BA	1	36.086	7.315	1.981	32°-50'	16	51.994	11.908	1.5	13.127	13.658	18: SPECIAL BACKFACE CHAMFER	
	1	1.4207	0.2880	0.0780	32°-50'		2.0470	0.4688	0.06	0.5168	0.5377		
15BC	2	36.398	7.826	1.727	32°-50'	17	51.994	12.189	1.5	13.106	13.637		
	2	1.4330	0.3081	0.0680	32°-50'		2.0470	0.4799	0.06	0.5160	0.5369		
						*18	66.604	23.876	CH	25.095	25.626		
							2.6222	0.9400	CH	0.9880	1.0089		
<b>21 SERIES</b>													
21BA	1	34.557	9.525	2.286	29°-20'	23	55.524	11.113	1.5	12.700	–		
	1	1.3605	0.3750	0.0900	29°-20'		2.1860	0.4375	0.06	0.5000	–		
21BC	2	34.930	10.231	2.057	29°-20'	24	55.524	11.908	1.5	12.692	13.406		
	2	1.3752	0.4028	0.0810	29°-20'		2.1860	0.4688	0.06	0.4997	0.5278		
<b>31 SERIES</b>													
31BA	1	40.193	9.525	3.100	29°-36'	32	61.087	11.113	1.5	12.700	–		
	1	1.5824	0.3750	0.1220	29°-36'		2.4050	0.4375	0.06	0.5000	–		
31BC	2	40.620	10.338	2.794	29°-36'	32C	61.087	11.908	1.5	12.705	13.513		
	2	1.5992	0.4070	0.1100	29°-36'		2.4050	0.4688	0.06	0.5002	0.5320		
						32X	58.738	11.908	1.5	12.705	13.513		
							2.3125	0.4688	0.06	0.5002	0.5320		
						33	66.637	11.113	1.5	12.700	–		
							2.6235	0.4375	0.06	0.5000	–		

11

\*\*These Maximum Fillet Radii will be cleared by the Cone or Cup Radii.  
\*See Remarks Column.

STEERING GEAR SERIES CONTINUED ON NEXT PAGE

**STEERING GEAR BEARING – TYPE TSG**

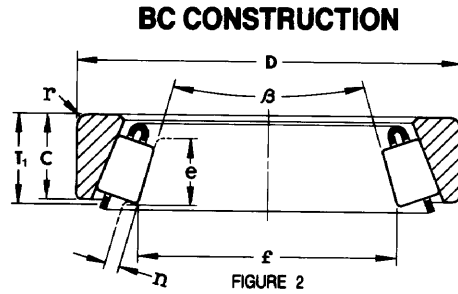
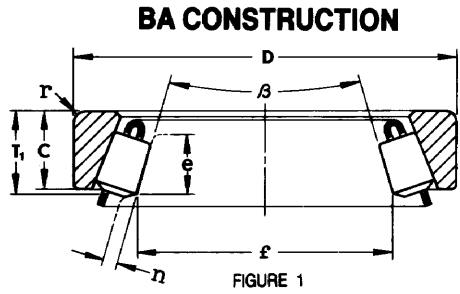

CAGE AND ROLLER						CUP			MAX. HOUSING FILLET RADIUS r	BA CONST. WIDTH T1	BC CONST. WIDTH T1	REMARKS
NUMBER	FIG. NO.	BASE DIA f	RACE LENGTH e	RIB HEIGHT n	CONE ANGLE	Number	OUTSIDE DIA. D	WIDTH c				
<b>35 SERIES</b>												
35BA	1	43.193	11.113	3.100	31°-52'	36X	64.287	13.096	1.5	13.096	13.904	
	1	1.7005	0.4375	0.1220	31°-52'		2.5310	0.5156	0.06	0.5156	0.5474	
35BC	2	12.471	11.113	2.794	31°-52'	*38A	69.850	23.368	CH	23.368	24.176	38A: SPECIAL BACKFACE CHAMFER
	2	1.7187	0.4375	0.1100	31°-52'		2.7500	0.9200	CH	0.9200	0.9518	
						*38AW	69.850	23.368	CH	23.368	24.178	38AW: SLOT IN OD SPECIAL BACKFACE CHAMFER
							2.7500	0.9200	CH	0.9200	0.9518	
						*38X	69.850	18.654	CH	18.616	19.423	38X: SLOT IN OD SPECIAL BACKFACE CHAMFER
							2.7500	0.7344	CH	0.7329	0.7647	
<b>45 SERIES</b>												
45BC	2	56.469	11.113	2.794	41°-36'	46	79.375	13.208	1.5	-	14.605	
	2	2.2232	0.4375	0.1100	41°-36'		3.1250	0.5200	0.06	-	0.5750	
						*47	87.313	25.654	CH	-	27.051	47: SPECIAL BACKFACE CHAMFER
							3.4375	1.0100	CH	-	1.0650	
						*47W	87.313	25.654	CH	-	27.051	47W: SLOT IN OD SPECIAL BACKFACE CHAMFER
							3.4375	1.0100	CH	-	1.0650	
<b>32207 SERIES</b>												
CB32207	2	47.345	16.000	3.683	20°-6'-56"	†Y-32207	72.000	19.000	2.0	-	19.743	
	2	1.8640	0.6299	0.1450	20°-6'-56"		2.8346	0.7480	0.06	-	0.7773	

STEERING GEAR SERIES CONTINUED ON NEXT PAGE

†These Maximum Fillet Radii will be cleared by the Cone or Cup Radii.  
†Bore or O.D. shown are maximum dimensions. \*See Remarks Column.

11

STEERING GEAR BEARING – TYPE TSG

BA CONSTRUCTION

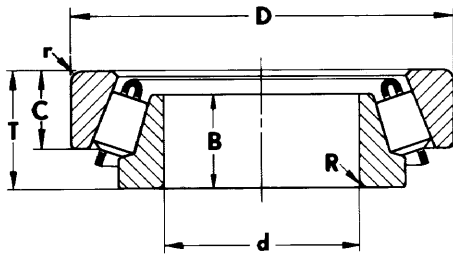

FIGURE 1

BC CONSTRUCTION

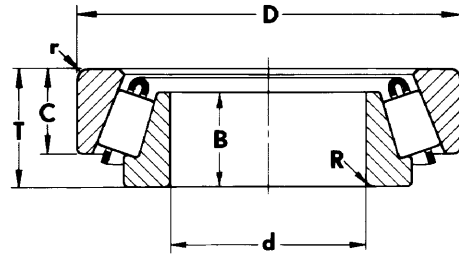

FIGURE 2

CONE – CAGE AND ROLLER				MAX. SHAFT FILLET RADIUS R	CUP			MAX. HOUSING FILLET RADIUS C1	BEARING WIDTH T	REMARKS	
NUMBER	FIG. NO.	BORE d	WIDTH B		Number	OUTSIDE DIA D	WIDTH C				
5 SERIES					6	44.450 1.7500	9.525 0.3750	1.5 0.06	13.492 0.5312	6CE: SPECIAL BACKFACE CHAMFER	
					*6CE	49.146 1.9349	19.050 0.7500	CH CH	22.898 0.9015		
	4CB-5BC	2	209.638	12.090	1.3						
		2	0.8125	0.4760	0.05	When these Cone - Cage Roller units are assembled cups in this series, add 0.744 mm (0.0293 in) to "T" dimensions.					
	4CX-5BC	2	19.588	12.090	0.3						
	2	0.7712	0.4760	0.01							
31 SERIES	29-31BA	1	30.163	16.662	1.5	32	61.087	11.113	1.5	19.050	
		1	1.1875	0.6560	0.06		2.4050	0.4375	0.06	0.7500	
						32X	58.738	11.908	1.5	19.055	
						2.3125	0.4688	0.06	0.7502		
35 SERIES	40-35BC	2	30.124	15.479	1.3	36X	64.287	13.096	1.5	18.273	
		2	1.1860	0.6094	0.05		2.5310	0.5156	0.06	0.7194	

\*\*These Maximum Fillet Radii will be cleared by the Cone or Cup Radii.

CROSSED ROLLER BEARINGS CONTINUED ON NEXT PAGE

\*See Remarks Column.

# CROSSED ROLLER BEARING

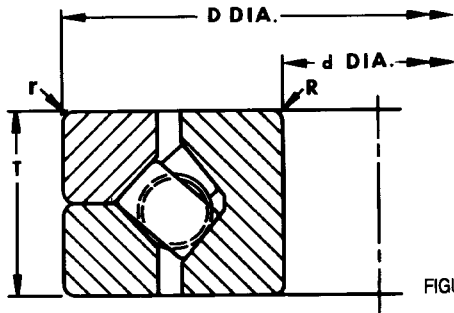

FIGURE 1

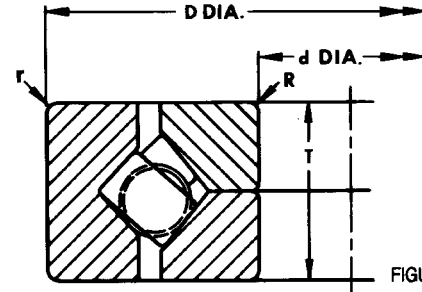

FIGURE 2

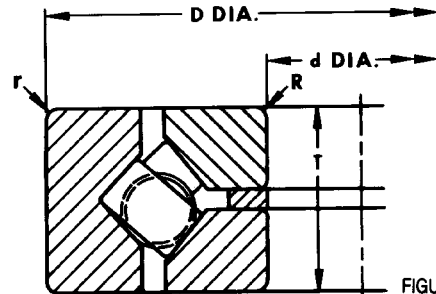

FIGURE 3

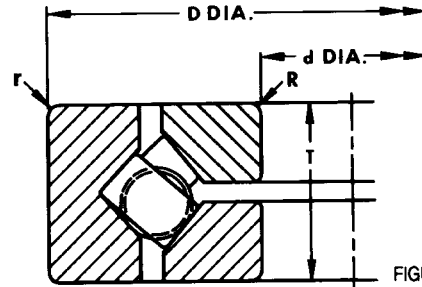

FIGURE 4

BEARING NUMBER	FIG NO	Bore d	OD D	Cone Max SHAFT Width T	CUP Max SHAFT FILLET RADIUS R	FILLET RADIUS r	Remarks
*XR496051	4	203.200	279.400	31.750	1.5	1.5	Assembled with XR496002 rollers & K11531 roller extensions
	4	8.0000	11.0000	1.2500	0.06	0.06	
*XR496052	1	203.200	279.400	31.750	1.5	1.5	As XR496050 but fitted with nylon separators
	1	8.0000	11.0000	1.2500	0.06	0.06	
*XR496053	4	203.200	279.400	31.750	1.5	1.5	As XR496051 but fitted with phos bronze separators and K444680 roller extensions
	4	8.0000	11.0000	1.2500	0.06	0.06	
JXR637050	4	300.000	400.000	36.492	1.5	1.5	
	4	11.8110	15.7480	1.4367	0.06	0.06	
XR637050	4	300.000	400.000	37.000	1.5	1.5	
	4	11.8110	15.7480	1.4567	0.06	0.06	
JXR652050	4	310.000	425.000	45.000	2.5	2.5	
	4	12.2047	16.7323	1.7716	0.10	0.10	
*XR678052	4	330.200	457.200	63.500	3.3	3.3	Replaces XR678050 assembled with XR678002 rollers
	4	13.0000	18.0000	2.5000	0.13	0.13	
*XR678053	4	330.200	457.200	63.500	3.3	3.3	Replaces XR678051 assembled with XR678002 rollers
	4	13.0000	18.0000	2.5000	0.13	0.13	
JXR678054	3	300.000	480.000	60.000	3.0	1.5	
	3	11.8110	18.8976	2.3622	0.12	0.06	
JXR699050	4	370.000	495.000	50.000	3.0	3.0	
	4	14.5669	19.4882	1.9685	0.12	0.12	
XR736052	1	432.003	571.500	38.100	3.3	3.3	
	1	17.0080	22.5000	1.5000	0.13	0.13	
*XR766051	4	457.200	609.600	63.500	3.3	3.3	Replaces XR766050 assembled with XR766002 rollers & K115353 roller ext.
	4	18.0000	24.0000	2.5000	0.13	0.13	
XR766052	4	424.950	614.924	65.000	CH	CH	
	4	16.7303	24.2096	2.5591	CH	CH	
*XR766053	4	457.200	609.600	63.500	3.3	3.3	As XR766051 but with holes in outer ring
	4	18.0000	24.0000	2.5000	0.13	0.13	
XR820060	4	580.000	760.000	80.000	6.4	6.4	
	4	22.8346	29.9213	3.1496	0.25	0.25	

CROSSED ROLLER BEARINGS CONTINUED ON NEXT PAGE

\*See Remarks Column.

11

CROSSED ROLLER BEARING

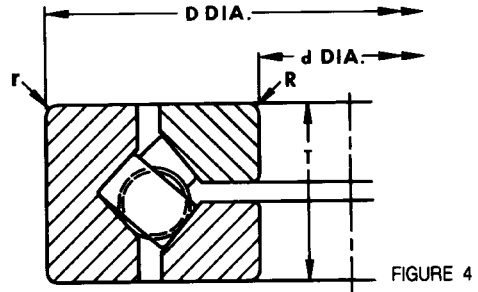
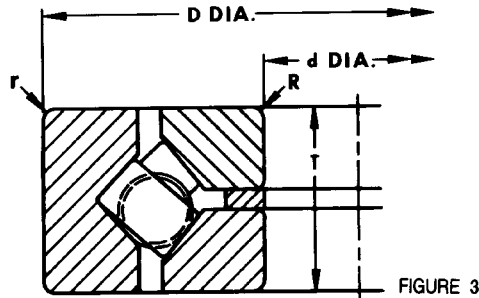
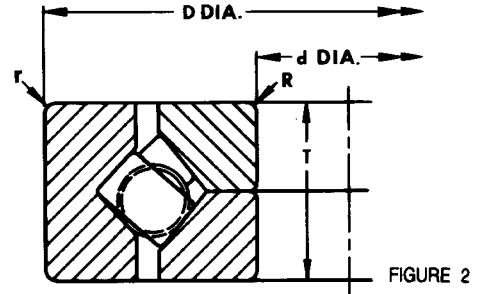
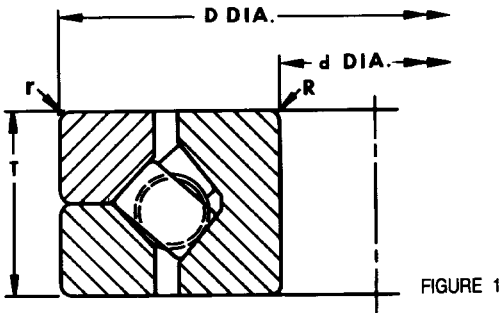

BEARING NUMBER	FIG NO	Bore d	OD D	Cone Max SHAFT Width T	CUP Max SHAFT FILLET RADIUS R	FILLET RADIUS r	Remarks
*XR820061	1	580.000	760.000	80.000	6.4	6.4	Replaces XR820053, 56, & 57
	1	22.8346	29.9213	3.1496	0.25	0.25	
*XR820067	1	580.000	760.000	80.000	6.4	6.4	Replaces XR820055 & 58
	1	22.8346	29.9213	3.1496	0.25	0.25	
XR820068	1	580.000	760.000	80.000	6.4	6.4	
	1	22.8346	29.9213	3.1496	0.25	0.25	
XR836050	3	600.000	830.000	80.000	3.3	3.3	
	3	23.6220	32.6772	3.1496	0.13	0.13	
XRS844050	2	685.800	914.400	79.375	0.8	CH	
	2	29.3157	33.4446	1.3386	0.03	CH	
*XR855053	4	685.800	914.400	79.375	3.3	3.3	Replaces XR855051
	4	27.0000	36.0000	3.1250	0.13	0.13	
*XR855055	4	685.800	914.400	79.375	3.3	3.3	Replaces XR855050 & 52
	4	27.0000	36.0000	3.1250	0.13	0.13	
*XR855056	1	685.800	914.400	79.375	3.3	3.3	Assembled with phosphor bronze separators
	1	27.0000	36.0000	3.1250	0.13	0.13	
*XR882054	1	901.700	1117.600	82.550	3.3	3.3	Replaces XR882052
	1	35.5000	44.0000	3.2500	0.13	0.13	
*XR882055	4	901.700	1117.600	82.550	3.3	3.3	Replaces XR882053
	4	35.5000	44.0000	3.2500	0.13	0.13	
*XR882058	2	939.800	1117.600	82.550	3.3	3.3	Replaces XR882051
	2	37.0000	44.0000	3.2500	0.13	0.13	
*XR889058	1	1028.700	1327.150	114.300	3.3	3.3	
	1	40.5000	52.2500	4.5000	0.13	0.13	
*XR889059	1	1028.700	1327.150	95.250	3.3	3.3	Replaces XR889056
	1	40.5000	52.2500	3.7500	0.13	0.13	
*XR889060	3	1028.600	1327.050	114.300	3.3	3.3	Assembled with XR889002 rollers & K115357 roller extensions includes gear & flange ring Replaces XR889057
	3	40.4960	52.2460	4.5000	0.13	0.13	
*XR897051	4	1549.400	1828.800	101.600	3.3	3.3	Replaces XR897050
	4	61.0000	72.0000	4.0000	0.13	0.13	

\*See Remarks Column.

THRUST BEARINGS CONTINUED ON NEXT PAGE

# THRUST BEARINGS – TTSP

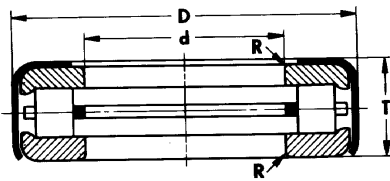

FIGURE 1

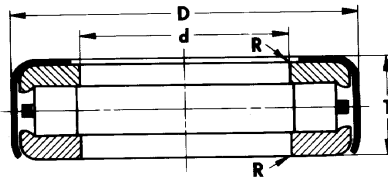

FIGURE 2

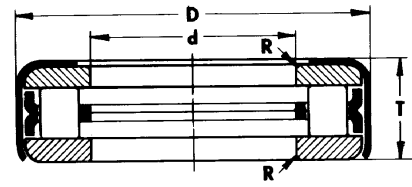

FIGURE 3

BEARING NUMBER		FIG NO.	BORE d	OUTSIDE DIAMETER D	WIDTH t	SHAFT FILLET RADIUS R	MASS kg (lb)	REMARKS
NO OIL HOLES IN RETAINER	OIL HOLES IN RETAINER							
T63	T63W	1	16.129	41.275	12.700	0.8	0.08	T92 HAS 2 BORES, OTHER BORE =24.054 mm (.9470"), R = .08 mm (.03").
		1	0.6350	1.6250	0.5000	0.03	0.18	
T76	T76W	1	19.304	41.275	13.487	0.8	0.08	
		1	0.7600	1.6250	0.5310	0.03	0.18	
T77	T77W	1	19.304	41.275	12.700	0.8	0.07	
		1	0.7600	1.6250	0.5000	0.03	0.15	
T82	T82W	1	20.879	41.275	13.487	0.8	0.07	
		1	0.8220	1.6250	0.5310	0.03	0.15	
T86		1	20.257	39.688	14.288	1.3	0.07	
		1	0.7975	1.5625	0.5625	0.05	0.15	
T88	T88W	1	22.479	48.021	15.088	0.8	0.11	
		1	0.8850	1.8906	0.5940	0.03	0.24	
T89		1	22.479	48.021	15.875	0.8	0.12	
		1	0.8850	1.8906	0.6250	0.03	0.26	
*T92		2	23.825	44.958	13.487	0.8	-	
		2	0.9380	1.7700	0.5310	0.03	-	
T93		2	24.054	44.958	13.487	0.8	0.09	
		2	0.9470	1.7700	0.5310	0.03	0.20	
T94	T94W	1	24.054	48.021	15.088	0.8	0.11	
		1	0.9470	1.8906	0.5940	0.03	0.24	
T95	T95W	1	24.130	50.800	15.875	0.8	0.13	
		1	0.9500	2.0000	0.6250	0.03	0.29	
T101	T101W	1	25.654	50.800	15.875	0.8	0.13	
		1	1.0100	2.0000	0.6250	0.03	0.29	
*T101X		1	25.146	50.800	15.875	0.8	-	
		1	0.9900	2.0000	0.6250	0.03	-	
*T102		1	25.654	50.800	16.916	0.8	-	
		1	1.0100	2.0000	0.6660	0.03	-	
T104	T104W	1	26.289	50.800	15.875	0.8	0.13	
		1	1.0350	2.0000	0.6250	0.03	0.29	
*T105		1	25.654	50.800	15.875	0.8	-	
		1	1.0100	2.0000	0.6250	0.03	-	
T107	T107W	1	27.299	50.800	15.875	0.8	0.12	
		1	1.0720	2.0000	0.6250	0.03	0.26	
T110	T110W	1	28.829	53.188	15.875	0.8	0.14	
		1	1.1350	2.0940	0.6250	0.03	0.31	
T113	T113W	1	28.829	55.562	15.875	0.8	0.15	
		1	1.1350	2.1875	0.6250	0.03	0.33	
*T114	*T114W	1	25.654	55.562	15.875	0.8	-	
		1	1.0100	2.1875	0.6250	0.03	-	
*T114X		2	28.829	50.800	15.875	0.8	-	
		2	1.1350	2.0000	0.6250	0.03	-	
T119	T119W	1	30.416	55.562	15.875	0.8	0.15	
		1	1.1975	2.1875	0.6250	0.03	0.33	
T120		2	30.416	54.745	11.430	0.8	0.11	
		2	1.1975	2.1553	0.4500	0.03	0.24	
T121		1	30.716	55.562	15.875	0.8	0.16	
		1	1.2093	2.1875	0.6250	0.03	0.35	

T126 SERIES CONTINUED ON NEXT PAGE

These Maximum Fillet Radii will be cleared by the Cone or Cup Radii.  
\*See Remarks Column.

11

## THRUST BEARINGS - TTSP

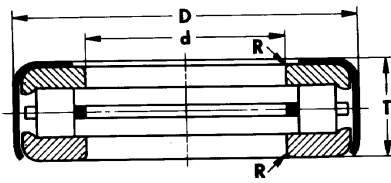

FIGURE 1

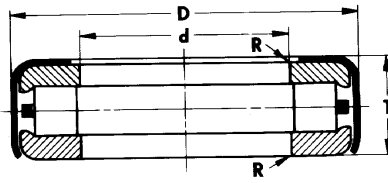

FIGURE 2

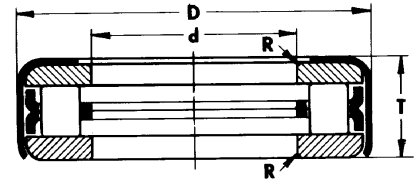

FIGURE 3

BEARING NUMBER		FIG NO.	BORE d	OUTSIDE DIAMETER D	WIDTH t	SHAFT FILLET RADIUS R	MASS kg (lb)	REMARKS
NO OIL HOLES IN RETAINER	OIL HOLES IN RETAINER							
T126	T126W	1	32.004	55.562	15.875	0.8	0.14	T126A - 2 CAGES
		1	1.2600	2.1875	0.6250	0.03	0.31	
*T126A	T126AW	1	32.004	55.562	15.875	0.8	0.14	RACES ARE CADMIUM PLATED.
		1	1.2600	2.1875	0.6250	0.03	0.31	
T139	T139W	1	35.179	58.738	15.875	0.8	0.15	RACES ARE CADMIUM PLATED.
		1	1.3850	2.3125	0.6250	0.03	0.33	
*T139KP		1	35.179	58.738	15.875	0.8	0.15	RACES ARE CADMIUM PLATED.
		1	1.3850	2.3125	0.6250	0.03	0.33	
T142	T142W	1	35.179	62.708	19.431	0.8	0.23	RACES ARE CADMIUM PLATED.
		1	1.3850	2.4688	0.7650	0.03	0.51	
T149	T149W	1	38.303	65.883	19.431	0.8	0.24	RACES ARE CADMIUM PLATED.
		1	1.5080	2.5938	0.7650	0.03	0.53	
T158		1	40.234	65.883	19.431	0.8	0.23	RACES ARE CADMIUM PLATED.
		1	1.5840	2.5938	0.7650	0.03	0.51	
T199	T199W	1	51.054	74.612	15.875	0.8	0.20	RACES ARE CADMIUM PLATED.
		1	2.0100	2.9375	0.6250	0.03	0.44	
T309	T309W	1	78.583	102.395	15.875	0.8	0.29	RACES ARE CADMIUM PLATED.
		1	3.0938	4.0313	0.6250	0.03	0.64	
T387	T387W	1	96.425	127.000	17.463	0.8	0.50	RACES ARE CADMIUM PLATED.
		1	3.8750	5.0000	0.7650	0.03	1.10	
T484		1	123.012	152.400	17.463	0.8	0.63	RACES ARE CADMIUM PLATED.
		1	4.8430	6.0000	0.6875	0.03	1.39	
T581		1	147.638	177.800	17.463	0.8	0.89	RACES ARE CADMIUM PLATED.
		1	5.8125	7.0000	0.6875	0.03	1.96	
T1760		3	44.623	76.200	10.922	0.8	0.18	RACES ARE CADMIUM PLATED.
		3	1.7568	3.0000	0.4300	0.03	0.4	

\*\*These Maximum Fillet Radii will be cleared by the Cone or Cup Radii.  
\*See Remarks Column.

T127 SERIES CONTINUED ON NEXT PAGE

# THRUST BEARINGS – TTC and TTCS

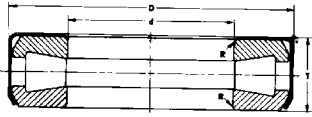

FIGURE 1



FIGURE 2

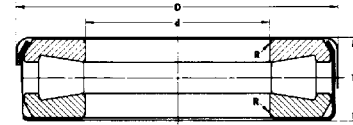

FIGURE 3

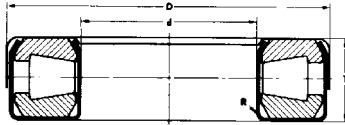

FIGURE 4

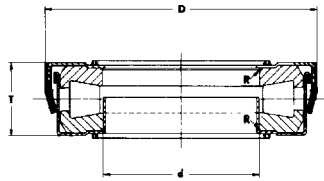

FIGURE 5

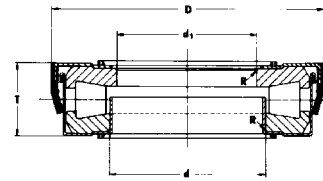

FIGURE 6

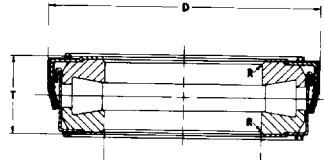

FIGURE 7

BEARING NUMBER		FIG NO.	BORE d	OUTSIDE DIAMETER D	WIDTH t	SHAFT FILLET RADIUS R	MASS kg (lb)	REMARKS
NO OIL HOLES IN RETAINER	OIL HOLES IN RETAINER							
T127	T127W	1	32.004	66.675	19.446	0.8	0.31	
		1	1.2600	2.6250	0.7656	0.03	0.68	
T128		2	32.004	66.675	18.654	0.8	0.29	
		2	1.2600	2.6250	0.7344	0.03	0.64	
T130		1	27.102	66.675	19.446	0.8	0.34	
		1	1.0670	2.6250	0.7656	0.03	0.75	
T136		2	35.179	66.675	18.654	0.8	0.28	
		2	1.3850	2.6250	0.7344	0.03	0.62	
T138	T138W	1	35.179	66.675	19.446	0.8	0.30	
		1	1.3850	2.6250	0.7656	0.03	0.66	
*T138XS		SPCL	35.179	66.675	19.446	0.8	-	T138XS HAS 2 BORES, OTHER BORE = 35.387mm (1.3972")
			1.3850	2.6250	0.7656	0.03	-	
T144	T144W	1	36.754	66.675	19.446	1.5	0.29	
		1	1.4470	2.6250	0.7656	0.06	0.64	
*T144XA		SPCL	36.754	66.675	19.446	1.5	-	T144XA HAS 2 BORES, OTHER BORE = 37.137mm (1.4621")
			1.4470	2.6250	0.7656	0.06	-	
T151	T151W	1	38.354	72.619	21.433	0.8	0.37	
		1	1.5100	2.8590	0.8438	0.03	0.82	
T151X		1	38.354	69.444	20.726	0.8	0.37	
		1	1.5100	2.7340	0.8160	0.03	0.82	
T152		2	38.354	72.619	20.638	0.8	0.35	
		2	1.5100	2.8590	0.8125	0.03	0.77	
T157	T157W	1	39.954	72.619	21.433	0.8	0.37	
		1	1.5730	2.8590	0.8438	0.03	0.82	
T163	T163W	1	41.529	72.619	21.433	0.8	0.35	
		1	1.6350	2.8590	0.8438	0.03	0.77	
T163X	T163XW	1	41.529	72.619	21.433	2.0	0.35	
		1	1.6350	2.8590	0.8438	0.80	0.77	
T169	T169W	1	43.104	82.956	23.812	0.8	0.55	
		1	1.6970	3.2660	0.9375	0.03	1.21	
T176	T176W	1	44.704	82.956	23.812	0.8	0.54	
		1	1.7600	3.2660	0.9375	0.03	1.19	
T177		1	45.000	73.000	20.000	0.8	0.32	
		1	1.7717	2.8740	0.7874	0.03	0.71	
T177A		1	45.484	73.000	20.000	0.8	0.33	
		1	1.7907	2.8740	0.7874	0.03	0.73	
*T177XA		SPCL	45.000	73.127	20.000	0.8	-	T177XA HAS 2 BORES, OTHER BORE = 45.484mm (1.7907")
			1.7717	2.8790	0.7874	0.03	-	
T177S		5	45.000	74.500	20.221	0.8	0.35	
		5	1.7717	2.9331	0.7961	0.03	0.77	
T178		1	40.401	73.000	19.000	0.8	-	
		1	1.5906	2.8740	0.7480	0.03	-	
T182	T182W	1	46.279	82.956	23.812	0.8	0.52	
		1	1.8220	3.2660	0.9375	0.03	1.15	

11



THRUST BEARINGS – TTC and TTCS

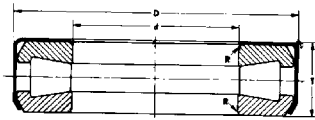

FIGURE 1

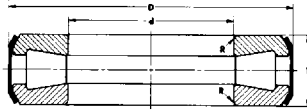

FIGURE 2

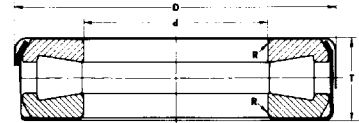

FIGURE 3



FIGURE 4

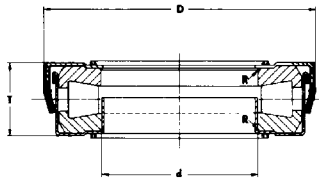

FIGURE 5

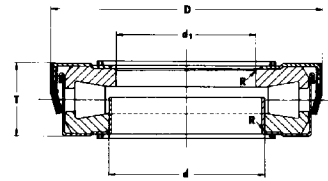

FIGURE 6

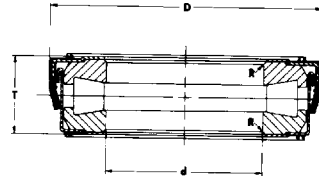

FIGURE 7

BEARING NUMBER		FIG NO.	BORE d	OUTSIDE DIAMETER D	WIDTH t	SHAFT FILLET RADIUS R	MASS kg (lb)	REMARKS
NO OIL HOLES IN RETAINER	OIL HOLES IN RETAINER							
T188	T188W	1	47.879	82.956	23.812	0.8	0.52	
		1	1.8850	3.2660	0.9375	0.03	1.15	
T188X		4	47.879	83.774	24.130	2.3	-	
		4	1.8850	3.2970	0.9500	0.09	-	
T189	T189W	2	47.879	82.956	23.020	0.8	0.50	
		2	1.8850	3.2660	0.9063	0.03	1.10	
T193	T193W	2	49.454	93.269	26.187	0.8	0.80	
		2	1.9470	3.6720	1.0310	0.03	1.76	
T194	T194W	1	49.454	93.269	26.975	0.8	0.81	
		1	1.9470	3.6720	1.0620	0.03	1.79	
T201	T201W	2	51.054	93.269	26.187	3.3	0.77	
		2	2.0100	3.6720	1.0310	0.13	1.70	
T202	T202W	1	51.054	93.269	26.975	3.3	0.80	
		1	2.0100	3.6720	1.0620	0.13	1.76	
T208	T208W	1	52.629	93.269	26.975	0.8	0.79	
		1	2.0720	3.6720	1.0620	0.03	1.74	
T209	T209W	2	52.629	93.269	26.187	0.8	0.75	
		2	2.0720	3.6720	1.0310	0.03	1.65	
T251	T251W	1	63.754	111.125	26.988	0.8	1.07	
		1	2.5100	4.3750	1.0625	0.03	2.36	
T252	T252W	2	63.754	111.125	25.796	0.8	1.07	
		2	2.5100	4.3750	1.0156	0.03	2.23	
T301	T301W	2	76.454	133.350	33.338	2.3	1.87	
		2	3.0100	5.2500	1.3125	0.09	4.12	
	T301X	2	76.454	133.350	33.338	2.3	-	
		2	3.0100	5.2500	1.3125	0.09	-	
T302	T302W	1	76.454	133.350	34.925	2.3	1.99	
		1	3.0100	5.2500	1.3750	0.09	4.39	
T350		2	88.900	133.350	33.335	2.8	1.41	
		2	3.5000	5.2500	1.3124	0.11	3.11	
T402	T402W	2	102.108	179.619	44.450	1.5	4.84	
		2	4.0200	7.0716	1.7500	0.06	10.67	
T600	T600W	1	152.400	241.300	76.200	3.3	14.10	
		1	8.0000	9.5000	3.0000	0.13	31.09	
T1260	T1260W	1	32.004	55.562	15.875	0.8	0.17	
		1	1.2600	2.1875	0.6250	0.03	0.37	
*T1380		SPCL	35.179	59.400	15.875	0.8	0.35	2 PIECE SEAL
		SPCL	1.3850	2.3386	0.6250	0.03	0.77	
T1921		1	46.279	80.010	15.977	0.8	0.34	
		1	1.8220	3.1500	0.6290	0.03	0.75	
T4020		2	102.108	179.619	31.750	1.5	3.7	
		2	4.0200	7.0716	1.2500	0.06	8.16	

\*\*These Maximum Fillet Radii will be cleared by the Cone or Cup Radii.  
\*See Remarks Column.

T135 SERIES CONTINUED ON NEXT PAGE

11

# THRUST BEARINGS – TTHD



FIGURE 1

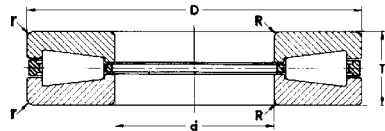

FIGURE 2

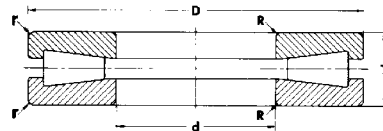

FIGURE 3

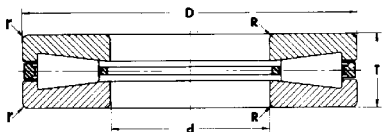

FIGURE 4

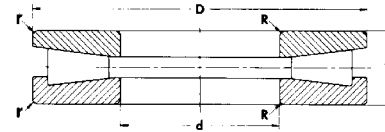

FIGURE 5

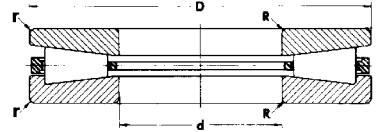

FIGURE 6

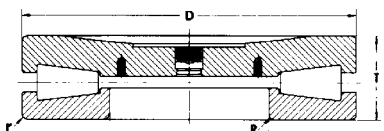

FIGURE 7

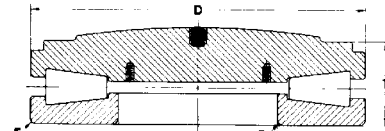

FIGURE 8

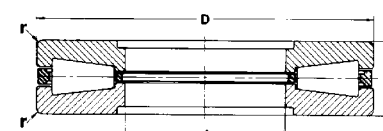

FIGURE 9



FIGURE 10

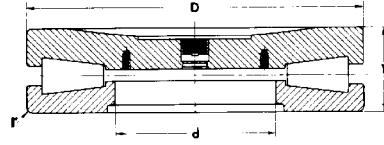

FIGURE 11

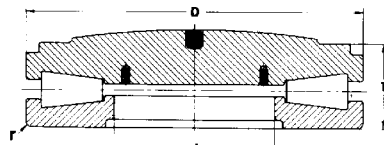

FIGURE 12

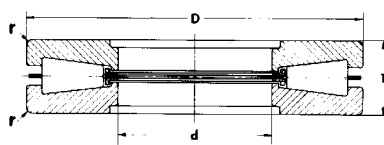

FIGURE 13

BEARING NUMBER	FIG NO.	BORE d	OUTSIDE DIAMETER D	WIDTH T	SHAFT FILLET RADIUS R	HOUSNG FILLET RADIUS r	MASS kg (lb)	REMARKS
T135	2	34.925	76.200	15.875	1.5	1.5	0.4	T311FS - T311S, SPHERICAL RADIUS = 457.200 mm (18")
	2	1.3750	3.0000	0.6250	0.06	0.06	0.88	
T135F	1	34.925	76.200	15.875	1.5	1.5	0.4	
	1	1.3750	3.0000	0.6250	0.06	0.06	0.88	
T200A	2	50.800	109.538	22.225	2.3	2.3	1.1	
	2	2.0000	4.3125	0.8750	0.09	0.09	2.40	
T311	2	76.200	161.925	33.338	3.3	3.3	3.6	
	2	3.0000	6.3750	1.3215	0.13	0.13	8.02	
T311F	1	76.200	161.925	33.338	3.3	3.3	3.6	
	1	3.0000	6.3750	1.3215	0.13	0.13	8.02	
*T311FS - T311S	8	76.200	161.925	49.212	3.3	3.3	-	
	8	3.0000	6.3750	1.9375	0.13	0.13	-	
T411	2	101.600	215.900	46.038	3.3	3.3	8.9	
	2	4.0000	8.5000	1.8125	0.13	0.13	19.60	
T411F	1	101.600	215.900	46.038	3.3	3.3	8.9	
	1	4.0000	8.5000	1.8125	0.13	0.13	19.60	
*T411FAS - T411S	8	76.200	215.900	65.088	3.3	3.3	-	
	8	3.0000	8.5000	2.5625	0.13	0.13	-	
T441	2	111.760	223.520	55.880	3.3	3.3	11.4	
	2	4.4000	8.8000	2.2000	0.13	0.13	25.13	
T441F	1	111.760	223.520	55.880	3.3	3.3	11.4	
	1	4.4000	8.8000	2.2000	0.13	0.13	25.13	
T451	2	114.300	250.825	53.975	4.0	4.0	15.0	
	2	4.5000	9.8750	2.1250	0.16	0.16	33.07	
T511	2	127.000	266.700	58.738	4.8	4.8	17.8	
	2	5.0000	10.5000	2.3125	0.19	0.19	39.24	
T511A	2	128.588	266.700	58.738	4.8	4.8	17.8	
	2	5.0625	10.5000	2.3125	0.19	0.19	39.24	

T511F SERIES CONTINUED ON NEXT PAGE

\*These Maximum Fillet Radii will be cleared by the Cone or Cup Radii.  
\*See Remarks Column.

11

# THRUST BEARINGS - TTHD

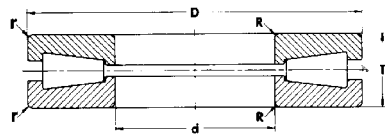

FIGURE 1

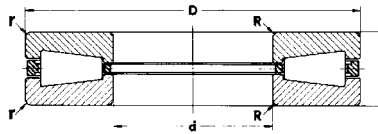

FIGURE 2

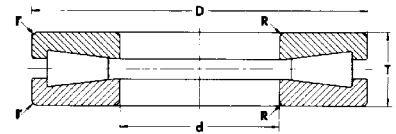

FIGURE 3



FIGURE 4

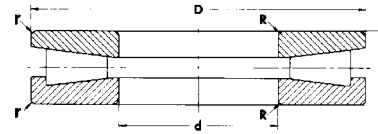

FIGURE 5

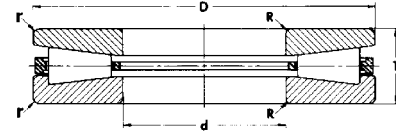

FIGURE 6

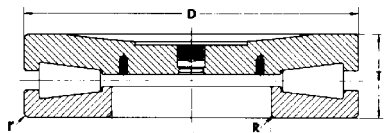

FIGURE 7

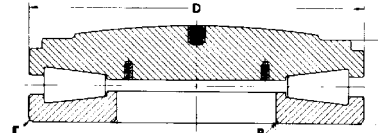

FIGURE 8

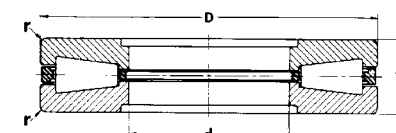

FIGURE 9

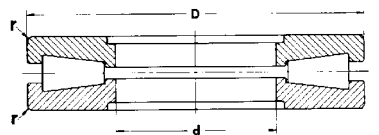

FIGURE 10

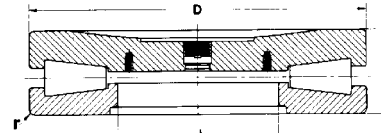

FIGURE 11

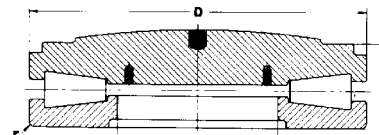

FIGURE 12

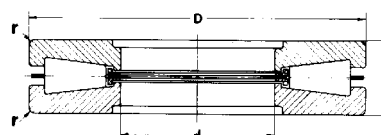

FIGURE 13

BEARING NUMBER	FIG NO.	BORE d	OUTSIDE DIAMETER D	WIDTH T	SHAFT FILLET RADIUS R	HOUSNG FILLET RADIUS r	MASS kg (lb)	REMARKS
T511F	1	127.000	266.700	58.738	4.8	4.8	17.8	
	1	5.0000	10.5000	2.3125	0.19	0.19	39.24	
*T511FS - T511S	8	127.000	266.700	79.375	4.8	4.8	-	T511FS - T511S, SPHERICAL RADIUS = 609.600 mm (24")
	8	5.0000	10.5000	3.1250	0.19	0.19	-	
*T511FSA - T511S	8	101.600	266.700	79.375	4.8	4.8	-	T511FSA - T511S, SPHERICAL RADIUS = 609.600 mm (24")
	8	4.0000	10.5000	3.1250	0.19	0.19	-	
*T511FSA - T511SA	7	101.600	266.700	79.375	4.8	4.8	-	T511FSA - T511SA, SPHERICAL RADIUS = 609.600 mm (24")
	7	4.0000	10.5000	3.1250	0.19	0.19	-	
T520	2	127.000	250.825	55.563	4.8	4.8	13.9	
	2	5.0000	9.8750	2.1875	0.19	0.19	30.64	
T611	2	152.400	317.500	69.850	6.4	6.4	29.3	
	2	6.0000	12.5000	2.7500	0.25	0.25	64.60	
T611F	1	152.400	317.500	69.850	6.4	6.4	29.3	
	1	6.0000	12.5000	2.7500	0.25	0.25	64.60	
*T611FS - T611S	8	152.400	317.500	87.313	6.4	6.4	-	T611FS - T611S, SPHERICAL RADIUS = 711.200 mm (28")
	8	6.0000	12.5000	3.4375	0.25	0.25	-	
*T611FS - T611SA	8	152.400	317.500	87.313	6.4	6.4	-	T611FS - T611SA, SPHERICAL RADIUS = 762.000 mm (30")
	8	6.0000	12.5000	3.4375	0.25	0.25	-	
*T611FSA - T611SA	7	SOLID	317.500	87.313	N/A	6.4	-	T611FSA - T611SA, SPHERICAL RADIUS = 762.000 mm (30")
	7		12.5000	3.4375	N/A	0.25	-	
*T611FS - T611SB	8	152.400	317.500	87.313	6.4	6.4	-	T611FS - T611SB, SPHERICAL RADIUS = 755.700 mm (29.75")
	8	6.0000	12.5000	3.4375	0.25	0.25	-	
T651	2	165.100	311.150	88.900	6.4	6.4	38.3	
	2	6.5000	12.2500	3.5000	0.25	0.25	84.44	
T661	2	168.275	304.800	69.850	6.4	6.4	27.8	
	2	6.6250	12.0000	2.7500	0.25	0.25	61.29	
T691	2	174.625	358.775	82.550	6.4	6.4	45.3	
	2	6.8750	14.1250	3.2500	0.25	0.25	99.87	

\*\*These Maximum Fillet Radii will be cleared by the Cone or Cup Radii.

\*See Remarks Column.

T709 SERIES CONTINUED ON NEXT PAGE

# THRUST BEARINGS – TTHD



FIGURE 1

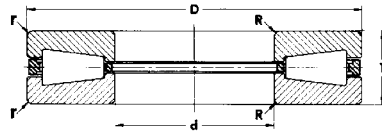

FIGURE 2

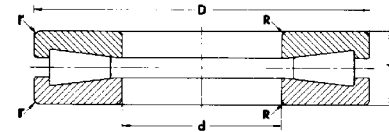

FIGURE 3

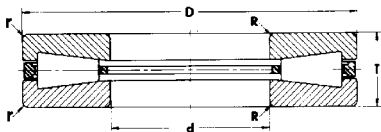

FIGURE 4

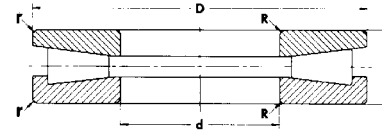

FIGURE 5

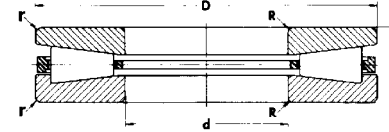

FIGURE 6

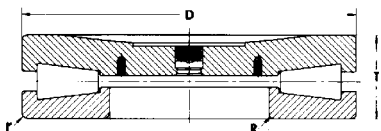

FIGURE 7

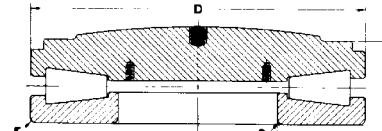

FIGURE 8

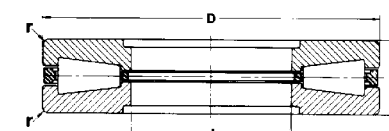

FIGURE 9

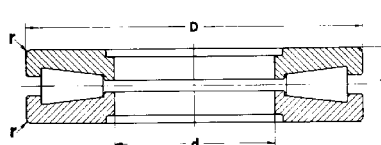

FIGURE 10

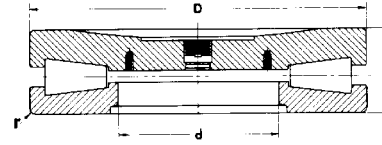

FIGURE 11

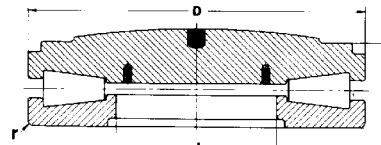

FIGURE 12

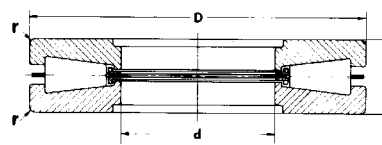

FIGURE 13

BEARING NUMBER	FIG NO.	BORE d	OUTSIDE DIAMETER D	WIDTH T	SHAFT FILLET RADIUS R	HOUSNG FILLET RADIUS r	MASS kg (lb)	REMARKS
T709	4	177.800	431.800	101.600	6.4	6.4	86.3	
	4	7.0000	17.0000	4.0000	0.25	0.25	190.26	
T711	2	177.800	368.300	82.550	8.0	8.0	48.4	
	2	7.0000	14.5000	3.2500	0.31	0.31	106.70	
T711F	1	177.800	368.300	82.550	8.0	8.0	48.4	
	1	7.0000	14.5000	3.2500	0.31	0.31	106.70	
T711FS - T711S	7	177.800	368.300	104.775	8.0	8.0	-	
	7	7.0000	14.5000	4.1250	0.31	0.31	-	
*T711FS - T711SA	8	177.800	368.300	101.600	8.0	8.0	-	T711FS - T711SA, SPHERICAL RADIUS = 762.000 mm (30")
	8	7.0000	14.5000	4.0000	0.31	0.31	-	
*T711FSS - T711S	7	SOLID	368.300	104.775	N/A	8.0	-	T711FSS - T711S, SPHERICAL RADIUS = 622.300 mm (24.5")
	7		14.5000	4.1250	N/A	0.31	-	
T811	2	203.200	419.100	92.075	9.7	9.7	69.3	
	2	8.0000	16.5000	3.6250	0.38	0.38	152.78	
T811F	1	203.200	419.100	92.075	9.7	9.7	69.3	
	1	8.0000	16.5000	3.6250	0.38	0.38	152.78	
*T811FS - T811S	7	203.200	419.100	123.825	9.7	9.7	-	T811FS - T811S, SPHERICAL RADIUS = 508.000 mm (20")
	7	8.0000	16.5000	4.8750	0.38	0.38	-	
*T811FS - T811SA	8	203.200	422.275	115.880	9.7	9.7	-	T811FS - T811SA, SPHERICAL RADIUS = 838.200 mm (33"), LOWER RACE OD = 419.100 mm (16.5000")
	8	8.0000	16.6250	4.5625	0.38	0.38	-	
*T811FSA - T811SB	7	SOLID	422.275	120.650	N/A	9.7	-	T811FSA - T811SB, SPHERICAL RADIUS = 506.000 mm (20"), LOWER RACE OD = 419.100 mm (16.5000")
	7		16.6250	4.7500	N/A	0.38	-	
T811X	2	203.200	419.100	120.650	9.7	9.7	92.7	
	2	8.0000	16.5000	4.7500	0.38	0.38	204.37	
*T811 - T811XA	2	203.200	419.100	106.363	9.7	9.7	-	T811 - T811XA, 2 BORES, OTHER BORE = 201.613 mm (7.9375")
	2	8.0000	16.5000	4.1875	0.38	0.38	-	

T911 SERIES CONTINUED ON NEXT PAGE

\*\*These Maximum Fillet Radii will be cleared by the Cone or Cup Radii.  
\*See Remarks Column.

11

# THRUST BEARINGS - TTHD

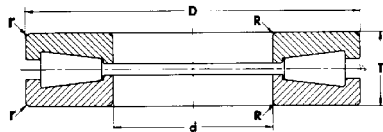

FIGURE 1

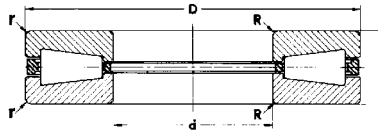

FIGURE 2

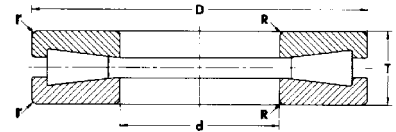

FIGURE 3



FIGURE 4

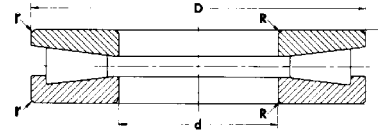

FIGURE 5

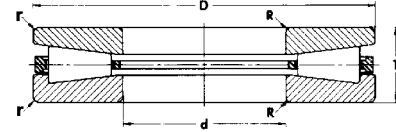

FIGURE 6

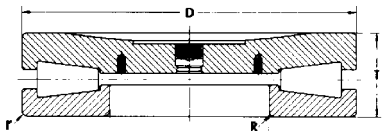

FIGURE 7

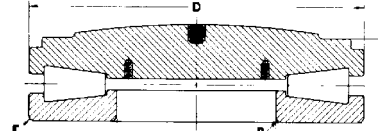

FIGURE 8

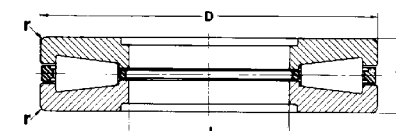

FIGURE 9

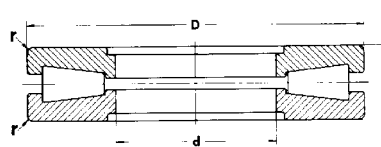

FIGURE 10

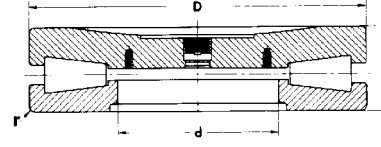

FIGURE 11

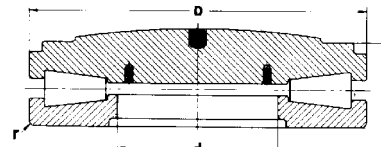

FIGURE 12

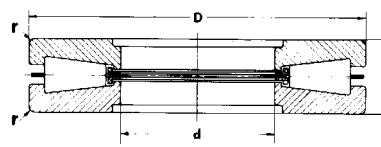

FIGURE 13

BEARING NUMBER	FIG NO.	BORE d	OUTSIDE DIAMETER D	WIDTH T	SHAFT FILLET RADIUS R	HOUSNG FILLET RADIUS r	MASS kg (lb)	REMARKS
T911	9	228.600	482.600	104.775	N/A	11.2	105.0	T911 - T911A, 2 BORES, OTHER BORE = 234.950 mm (9.2500") T911FS - T911S, SPHERICAL RADIUS = 635.000 mm (25") T911FS - T911SA, SPHERICAL RADIUS = 1295.400 mm (51") T911FS - T911SB, SPHERICAL RADIUS = 895.350 mm (35.25") T1011FS - T1011S, SPHERICAL RADIUS = 1066.8 mm (42") T1011FS - T1011SA, SPHERICAL RADIUS = 635.000 mm (25") T1011FS - T1011SC, SPHERICAL RADIUS = 635.000 mm (25")
	9	9.0000	19.0000	4.1250	N/A	0.44	231.49	
T911A	9	234.950	482.600	104.775	N/A	11.2	103.0	
	9	9.2500	19.0000	4.1250	N/A	0.44	227.08	
T911F	10	228.600	482.600	104.775	N/A	11.2	-	
	10	9.0000	19.0000	4.1250	N/A	0.44	-	
*T911 - T911A	9	228.600	482.600	104.775	N/A	11.2	-	
	9	9.0000	19.0000	4.1250	N/A	0.44	-	
*T911FS - T911S	11	228.600	482.600	146.050	N/A	11.2	-	
	11	9.0000	19.0000	5.7500	N/A	0.44	-	
*T911FS - T911SA	12	228.600	482.600	131.763	N/A	11.2	-	
	12	9.0000	19.0000	5.1875	N/A	0.44	-	
*T911FS - T911SB	12	228.600	482.600	114.300	N/A	11.2	-	
	12	9.0000	19.0000	4.5000	N/A	0.44	-	
T921	9	234.950	546.100	127.000	N/A	16.0	171.0	
	9	9.2500	21.5000	5.0000	N/A	0.63	376.99	
T921F	10	234.950	546.100	127.000	N/A	16.0	171.0	
	10	9.2500	21.5000	5.0000	N/A	0.63	376.99	
T1011	9	254.000	539.750	117.475	N/A	11.2	147.0	
	9	10.0000	21.2500	4.6250	N/A	0.44	324.08	
*T1011FS - T1011S	12	254.000	539.750	149.225	N/A	11.2	-	
	12	10.0000	21.2500	5.8750	N/A	0.44	-	
*T1011FS - T1011SA	11	254.000	539.750	158.750	N/A	11.2	-	
	11	10.0000	21.2500	6.2500	N/A	0.44	-	
*T1011FS - T1011SC	11	254.000	539.750	158.750	N/A	11.2	-	
	11	10.0000	21.2500	6.2500	N/A	0.44	-	
T1115	9	279.400	495.300	133.350	N/A	6.4	125.0	
	9	11.0000	19.5000	5.2500	N/A	0.25	275.58	

\*These Maximum Fillet Radii will be cleared by the Cone or Cup Radii.

\*See Remarks Column.

T1120 SERIES CONTINUED ON NEXT PAGE

11

# THRUST BEARINGS – TTHD



FIGURE 1

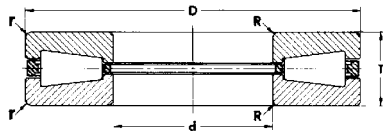

FIGURE 2



FIGURE 3



FIGURE 4

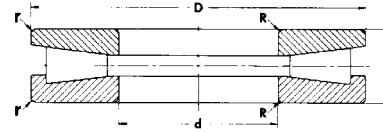

FIGURE 5

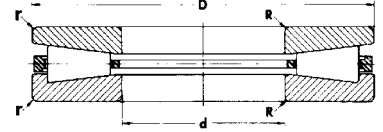

FIGURE 6

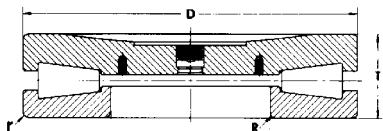

FIGURE 7

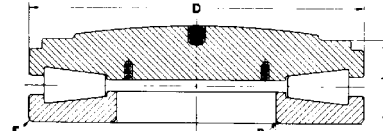

FIGURE 8

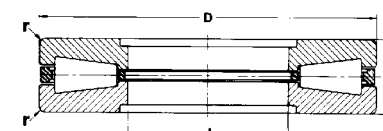

FIGURE 9

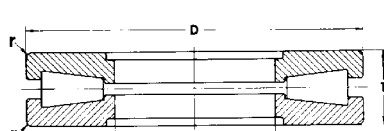

FIGURE 10

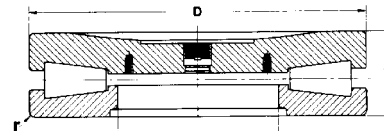

FIGURE 11

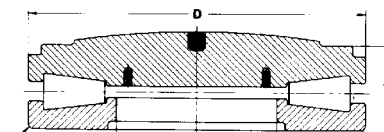

FIGURE 12

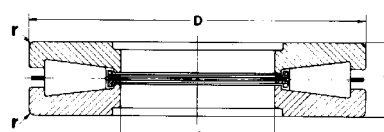

FIGURE 13

BEARING NUMBER	FIG NO.	BORE d	OUTSIDE DIAMETER D	WIDTH T	SHAFT FILLET RADIUS R	HOUSNG FILLET RADIUS r	MASS kg (lb)	REMARKS
T1120	9	279.400	603.250	136.525	N/A	11.2	212.0	T1120FS - T1120S, SPHERICAL RADIUS = 1308.1 mm (51.5")
	9	11.0000	23.7500	5.3750	N/A	0.44	467.38	
T1120F	10	279.400	603.250	136.525	N/A	11.2	212.0	
	10	11.0000	23.7500	5.3750	N/A	0.44	467.38	
*T1120FS - T1120S	12	279.400	603.250	136.525	N/A	11.2	-	
	12	11.0000	23.7500	5.3750	N/A	0.44	-	
T1421	9	355.600	533.400	101.600	N/A	6.4	84.1	
	9	14.0000	21.0000	4.0000	N/A	0.25	185.41	
T1421F	10	355.600	533.400	101.600	N/A	6.4	84.1	
	10	14.0000	21.0000	4.0000	N/A	0.25	185.41	
T1750	2	44.450	84.734	18.258	2.3	2.3	0.5	
	2	1.7500	3.3360	0.7188	0.09	0.09	1.08	
T2520	2	63.500	117.475	25.400	2.3	2.3	1.3	
	2	2.5000	4.6250	1.0000	0.09	0.09	2.95	
*T3004W	1	76.454	167.081	44.450	3.3	N/A	-	T3004W, RETAINER ON OD
	1	3.0100	6.5780	1.7500	0.13	N/A	-	
T7519	2	190.000	355.600	74.219	6.4	6.4	35.9	
	2	7.4803	14.0000	2.9220	0.25	0.25	79.15	
*T8920FA - T8920FB	11	168.275	638.175	152.400	N/A	11.0	-	NO SPHERICAL RADIUS
	11	6.6250	25.1250	6.0000	N/A	0.43	-	
T9020	9	228.600	431.800	88.773	N/A	9.7	65.7	
	9	9.0000	17.0000	3.4950	N/A	0.38	144.84	
*T9030FS - T9030S	7	SOLID	482.600	165.000	N/A	11.2	-	T9030FS - T9030S, SPHERICAL RADIUS = 635.000 mm (25")
	7		19.0000	6.5354	N/A	0.44	-	
*T9030FS - T9030SA	8	SOLID	482.600	150.622	N/A	11.2	-	T9030FS - T9030SA, SPHERICAL RADIUS = 1295.400 mm (51")
	8		19.0000	5.9300	N/A	0.44	-	
*T9030FSA - T9030SA	12	168.275	482.600	131.763	N/A	11.2	-	T9030FSA - T9030SA, SPHERICAL RADIUS = 1295.400 mm (51")
	12	6.6250	19.0000	5.1875	N/A	0.44	-	

T9030FSA SERIES CONTINUED ON NEXT PAGE

\*These Maximum Fillet Radii will be cleared by the Cone or Cup Radii.  
\*See Remarks Column.

# THRUST BEARINGS - TTHD

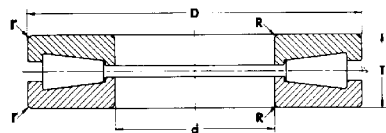

FIGURE 1

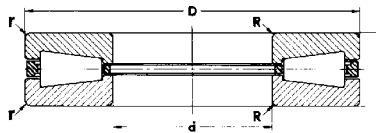

FIGURE 2

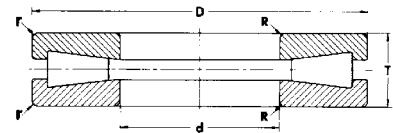

FIGURE 3

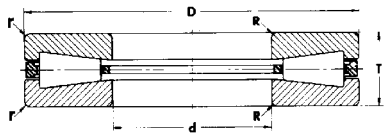

FIGURE 4

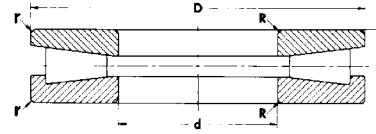

FIGURE 5

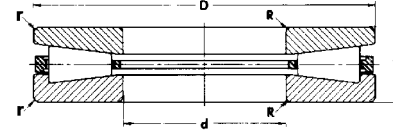

FIGURE 6

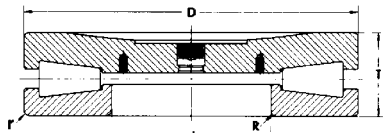

FIGURE 7

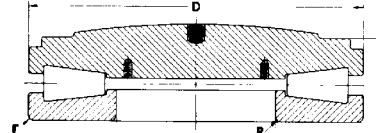

FIGURE 8

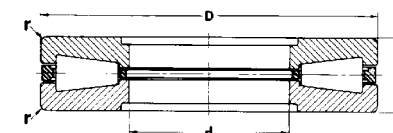

FIGURE 9

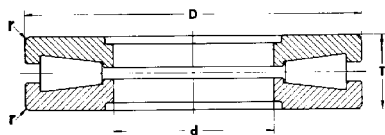

FIGURE 10

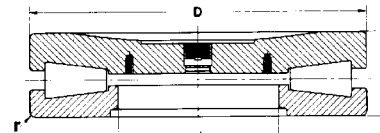

FIGURE 11

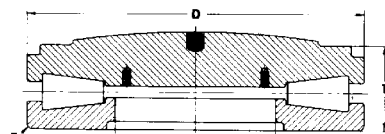

FIGURE 12

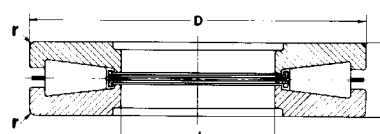

FIGURE 13

BEARING NUMBER	FIG NO.	BORE d	OUTSIDE DIAMETER D	WIDTH T	SHAFT FILLET RADIUS R	HOUSNG FILLET RADIUS r	MASS kg (lb)	REMARKS
*T9030FSA - T9030SB	12	168.275	482.600	131.763	N/A	11.2	-	T9030FSA - T9030SB, SPHERICAL RADIUS = 1066.800 mm (42")
	12	6.6250	19.0000	5.1875	N/A	0.44	-	
T9250F	10	234.950	546.100	127.000	N/A	16.0	-	
	10	9.2500	21.5000	5.0000	N/A	0.63	-	
T9250FA	10	139.700	546.100	127.000	N/A	16.0	-	
	10	5.5000	21.5000	5.0000	N/A	0.63	-	
*T9250FAS - T9250SA	12	139.700	549.275	155.575	N/A	16.0	-	T9250FAS - T9250SA, SPHERICAL RADIUS = 1295.400 mm (51")
	12	5.5000	21.6250	6.1250	N/A	0.63	-	
*T9250FAS - T9250SC	12	139.700	549.275	155.575	N/A	16.0	-	T9250FAS - T9250SC, SPHERICAL RADIUS = 1295.400 mm (51")
	12	5.5000	21.6250	6.1250	N/A	0.63	-	
*T9250FS - T9250S	11	234.950	546.100	168.275	N/A	16.0	-	T9250FS - T9250S, SPHERICAL RADIUS = 641.350 mm (25.25")
	11	9.2500	21.5000	6.6250	N/A	0.63	-	
*T9250FS - T9250SA	12	234.950	549.275	155.575	N/A	16.0	-	T9250FS - T9250SA, SPHERICAL RADIUS = 1295.400 mm (51")
	12	9.2500	21.6250	6.1250	N/A	0.63	-	
*T9250FS - T9250SB	11	234.950	546.100	171.450	N/A	16.0	-	T9250FS - T9250SB, SPHERICAL RADIUS = 558.800 mm (22")
	11	9.2500	21.5000	6.7500	N/A	0.63	-	
*T12040FS - T12040S	12	304.800	1146.175	317.500	N/A	19.0	-	T12040FS - T12040S, SPHERICAL RADIUS = 2000.250 mm (78.75"), LOWER RACE OD = 1143.000 mm (45.0000")
	12	12.0000	45.1250	12.5000	N/A	0.75	-	
*T14214	13	355.600	533.400	101.600	N/A	6.4	-	T14214, 2 BORES, OTHER BORE = 355.961 mm (14.0150")
	13	14.0000	21.0000	4.0000	N/A	0.25	-	
T14520	9	368.300	603.300	120.650	N/A	9.7	144.0	
	9	14.5000	23.7500	4.7500	N/A	0.38	317.47	
T16021	9	406.400	711.200	146.050	N/A	9.7	264.0	
	9	16.0000	28.0000	5.7500	N/A	0.38	582.02	
T16021F	10	406.400	711.200	146.050	N/A	9.7	264.0	
	10	16.0000	28.0000	5.7500	N/A	0.38	582.02	

\*\*These Maximum Fillet Radii will be cleared by the Cone or Cup Radii.

\*See Remarks Column.

T16050 SERIES CONTINUED ON NEXT PAGE

# THRUST BEARINGS – TTHD

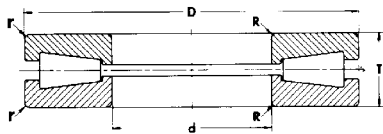

FIGURE 1

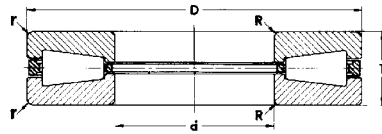

FIGURE 2

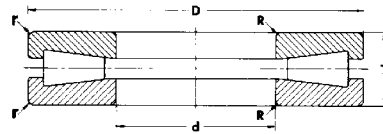

FIGURE 3



FIGURE 4

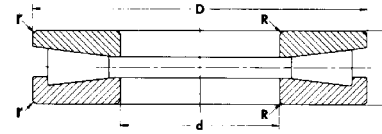

FIGURE 5

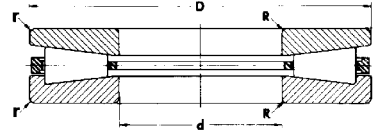

FIGURE 6

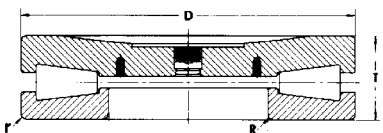

FIGURE 7

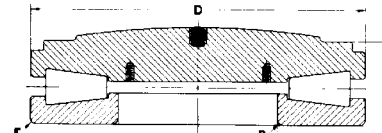

FIGURE 8

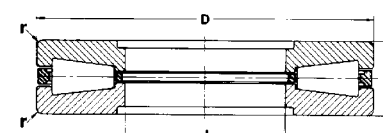

FIGURE 9



FIGURE 10

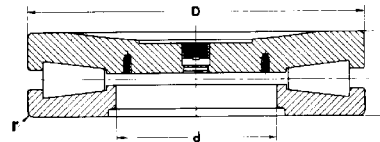

FIGURE 11

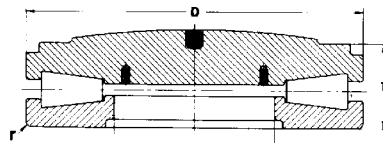

FIGURE 12

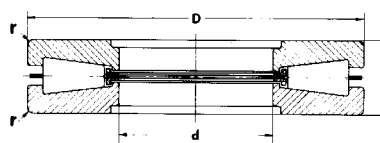

FIGURE 13

BEARING NUMBER	FIG NO.	BORE d	OUTSIDE DIAMETER D	WIDTH T	SHAFT FILLET RADIUS R	HOUSNG FILLET RADIUS r	MASS kg (lb)	REMARKS
T16050	9	406.400	838.200	177.800	N/A	12.7	517.0	
	9	16.0000	33.0000	7.0000	N/A	0.5	1139.79	
T17010FS - T17020S	12	431.800	942.975	260.350	N/A	12.7	-	
	12	17.0000	37.1250	10.2500	N/A	0.5	-	
T48000	9	1219.200	1524.000	136.525	N/A	9.7	596.0	
	9	48.0000	60.0000	5.3750	N/A	0.38	1313.95	

\*\*These Maximum Fillet Radii will be cleared by the Cone or Cup Radii.  
\*See Remarks Column.

11



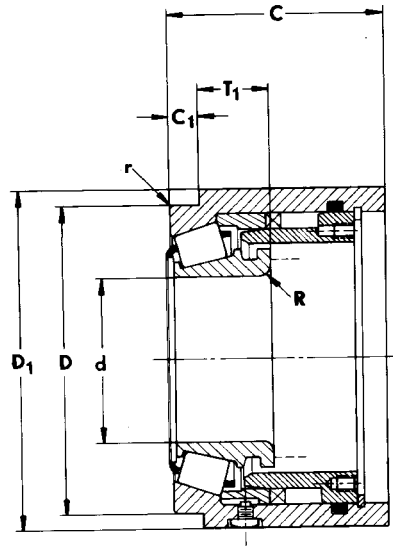

CONE			CUP					BEAR-ING	Remarks	
Number	BORE d	MAX SHAFT FILLET RAD R	Number	WIDTH C	MAX SHAFT FILLET RAD r	SEAT WIDTH D	SEAT DIA D	FLANGE DIA D1		WIDTH T
<b>JP5000</b>										
JP5049P	50.000 1.9685	3.0 0.12	JP5019HR	66.000 2.5984	1.0 0.04	15.000 0.5906	104.000 4.0945	103.500 4.0748	31.000 1.2205	
			JP5020HR	66.000 2.5984	1.0 0.04	15.000 0.5906	104.000 4.0945	103.175 4.0620	31.000 1.2205	
JP5049PH	50.000 1.9685	3.0 0.12	JP5017HR	66.000 2.5984	1.0 0.04	15.000 0.5906	104.000 4.0945	103.175 4.0620	31.000 1.2205	
			JP5020HR	66.000 2.5984	1.0 0.04	15.000 0.5906	104.000 4.0945	103.175 4.0620	31.000 1.2205	
<b>JP7500</b>										
JP7548P	75.000 2.9528	3.0 0.12	JP7520HR	65.000 2.5591	2.0 0.08	10.000 0.3937	122.000 4.8031	130.000 5.1181	22.000 0.8661	
JP7549P	75.000 2.9528	3.0 0.12	JP7519HR	65.000 2.5591	2.0 0.08	10.000 0.3937	122.000 4.8031	130.000 5.1181	22.000 0.8661	
<b>JP8500</b>										
JP8548	85.000 3.3465	3.0 0.12	JP8518HR	66.000 2.5984	2.0 0.08	10.000 0.3937	140.000 5.5118	148.000 5.8268	23.500 0.9252	
JP8549P	85.000 3.3465	3.0 0.12	JP8519HR	66.000 2.5984	2.0 0.08	10.000 0.3937	140.000 5.5118	148.000 5.8268	23.500 0.9252	
<b>JP10000</b>										
JP10048	95.000 3.7402	3.0 0.12	JP10019HR	70.000 2.7559	1.5 0.06	10.000 0.3937	145.000 5.7087	158.000 6.2205	21.000 0.8268	
			JP10019HRA	70.000 2.7559	1.5 0.06	10.000 0.3937	145.000 5.7087	158.000 6.2205	21.000 0.8268	
<b>JP11000</b>										
JP11035	100.000 3.9370	3.0 0.12	JP11019HR	70.000 2.7559	1.0 0.04	12.000 0.4724	170.000 6.6929	178.000 7.0079	27.000 1.0630	
JP11048	110.000 4.3307	3.0 0.12								
<b>JP12000</b>										
JP12043P	115.000 4.5276	3.0 0.12	JP12019HR	70.000 2.7559	1.0 0.04	12.000 0.4724	180.000 7.0866	190.000 7.4803	26.000 1.0236	
JP12049P	120.000 4.7244	3.0 0.12								

\*\*These Maximum Fillet Radii will be cleared by the Cone or Cup Radii.  
\*See Remarks Column.

# HYDRA-RIB™ BEARING

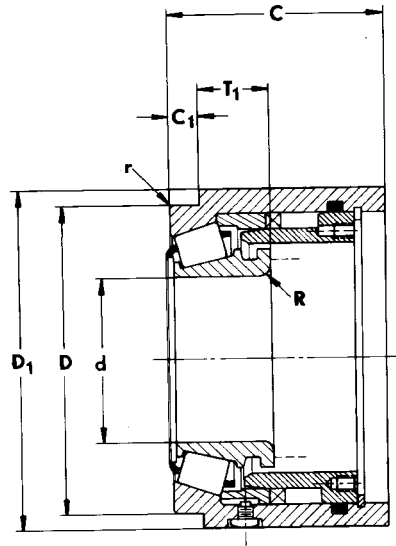

CONE			CUP						BEARING	Remarks
Number	BORE d	MAX SHAFT FILLET RAD R	Number	WIDTH C	MAX SHAFT FILLET RAD r	SEAT WIDTH D	SEAT DIA D	FLANGE DIA D1	WIDTH T	
<b>JP13000</b>										
JP13043P	125.000 4.9213	3.0 0.12	JP13016HR	72.000 2.8346	1.0 0.04	12.000 0.4724	190.000 7.4803	200.000 7.8740	29.000 1.1417	
JP13049P	130.000 5.1181	3.0 0.12								
<b>JP14000</b>										
JP14043P	135.000 5.3150	3.0 0.12	JP14019HR	72.000 2.8346	1.0 0.04	13.000 0.5118	205.000 8.0709	213.000 8.3858	27.000 1.0630	
JP14049P	140.000 5.5118	3.0 0.12								
<b>JP16000</b>										
JP16043P	155.000 6.1024	3.0 0.12	JP16019HR	76.000 2.9921	1.0 0.04	15.000 0.5906	227.000 8.9370	235.000 9.2520	30.000 1.1811	
JP16049P	160.000 6.2992	3.0 0.12								
<b>JP17000</b>										
JP17049P	170.000 6.6929	3.0 0.12	JP17019HR	79.000 3.1102	1.0 0.04	15.000 0.5906	240.000 9.4488	248.000 9.7638	30.000 1.1811	
<b>JP18000</b>										
JP18049P	180.000 7.0866	3.0 0.12	JP18019HR	84.000 3.3071	1.0 0.04	15.000 0.5906	260.000 10.2362	268.000 10.5512	30.000 1.1811	
<b>JP20000</b>										
JP20049P	200.000 7.8740	3.0 0.12	JP20019HR	83.000 3.2677	1.0 0.04	17.000 0.6693	282.000 11.1024	290.000 11.4173	32.000 1.2598	
<b>JP22000</b>										
JP22049E	220.000 8.6614	3.0 0.12	JP22019HR	83.000 3.2677	1.0 0.04	17.000 0.6693	308.000 12.1260	316.000 12.4409	32.000 1.2598	
<b>JL555000</b>										
JL555235	270.000 10.6299	4.0 0.16	JL555219HR	105.000 4.1339	4.0 0.16	20.000 0.7874	375.000 14.7638	385.000 15.1575	40.000 1.5748	
JL555239	285.750 11.2500	4.0 0.16								

UNIPAC™ SERIES CONTINUED ON NEXT PAGE

\*\*These Maximum Fillet Radii will be cleared by the Cone or Cup Radii.  
\*See Remarks Column.

11

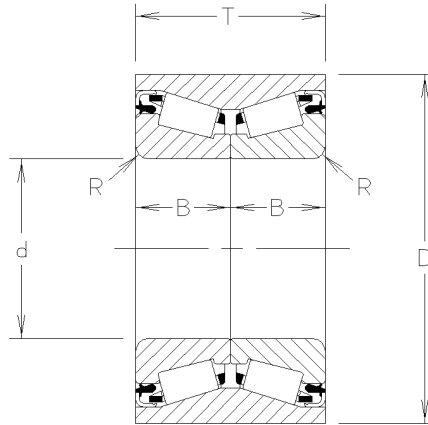

CONE			MAX SHAFT FILLET RADI R	CUP		BEARING	SEALS	REMARKS
SERIES	BORE d	WIDTH B		Number	OUTSIDE DIA D	WIDTH T		
<b>JRM3000</b> JRM3049	30.000 1.1811	19.507 0.7680	2.5 0.10	*JRM3010XDA	60.030 2.3634	37.000 1.4567	Y	JRM3010XDA: CHAMFER ON RIGHTFACE OD CHAMFER ON LEFTFACE OD
<b>JRM3400</b> *JRM3449	34.000 1.3386	19.507 0.7680	2.5 0.10	*JRM3410XD 2.6697	67.810 1.6929	43.000	N	JRM3410XD: GROOVE IN OD CENTER JRM3449: EXTENDED SMALL RIB SPECIAL BACKFACE RADIUS
<b>JRM3500</b> *JRM3534	34.000 1.3386	18.500 0.7284	N/A N/A	JRM3564XD	64.000 2.5197	37.000 1.4567	Y	JRM3534: SPECIAL BACKFACE CHAMFER SLOTS IN FRONTFACE
JRM3535	35.000 1.3780	18.500 0.7284	3.5 0.14					JRM3535X: SLOTS IN FRONTFACE
JRM3535H	35.000 1.3780	18.500 0.7284	3.5 0.14					JRM3536: ASSEMBLY JRM3536 / JRM3564XD DOES NOT HAVE SEAL
*JRM3535X	35.000 1.3780	18.500 0.7284	3.5 0.14					
JRM3535XA	35.000 1.3780	18.500 0.7284	3.5 0.14					
*JRM3536	35.000 1.3780	18.500 0.7284	3.5 0.14					
JRM3535A	35.000 1.3780	17.500 0.6890	1.8 0.07	JRM3565XD	65.000 2.5591	35.000 1.3780	Y	
<b>JRM3900</b> JRM3935A	35.000 1.3780	18.500 0.7284	2.5 0.10	JRM3968XD	68.000 2.6772	37.000 1.4567	Y	JRM3939W: SLOTS IN FRONTFACE
JRM3938A	38.125 1.5010	18.500 0.7284	2.0 0.08					JRM3939WA: SLOTS IN FRONTFACE
JRM3939	39.000 1.5354	18.500 0.7284	3.8 0.15					
JRM3939C	39.000 1.5354	18.500 0.7284	3.8 0.15					
*JRM3939W	39.000 1.5354	18.500 0.7284	3.8 0.15					
*JRM3939WA	39.000 1.5354	18.500 0.7284	3.8 0.15					
<b>JRM4000</b> JRM4040A	39.954 1.5730	16.500 0.6496	3.5 0.14	JRM4076XD	76.000 2.9921	28.000 1.1024	Y	
JRM4042	42.000 1.6535	20.000 0.7874	3.5 0.14	JRM4076XDA	76.000 2.9921	37.000 1.4567	Y	
<b>JRM4200</b> JRM4249	42.000 1.6535	19.500 0.7677	3.8 0.15	JRM4210XD	76.000 2.9921	39.000 1.5354	Y	
JRM4248	42.000 1.6535	19.075 0.7510	2.5 0.10	JRM4214XD	80.000 3.1496	38.000 1.4961	N	

\*\*These Maximum Fillet Radii will be cleared by the Cone or Cup Radii.  
\*See Remarks Column.

11

**K PARTS**

CUP	SERIES	CUP	SERIES
K24429	03000	K109521	475
K33867	15000	K109587	475
K35666	435	K109597	495
K35667	03000	K110108	HH224300
K38958	12500	K151586	EH239500
K39214	05000	K154600	15000
K46688	435	K302661	475
K78175	24700	K302664	395
K87718	595	K302667	33800
K88207	475	K302670	48200
K90651	03000	K302672	24700
K91179	435	K312462	495
K93494	78000	K312463	495
K93891	595	K312471	495
K94495	475	K312486	755
K97753	24700	K312489	475
K97770	03000	K312493	33800
K100019	475	K312494	HH229000
K100427	575	K312495	05000
K100825	33800	K326053	48200
K101989	595	K326068	HH221400
K102084	475	K326074	435
K103272	33800	K326078	HH228300
K103649	48200	K426864	H221600
K103951	835	K426866	33800
K104052	475	K426867	15000
K104220	575	K426894	395
K104429	475	K444665	33800
K104605	05000	K444666	24700
K104606	24700	K444675	595
K105665	56000	K444677	HH224300
K105666	56000	K516771	475
K106797	33800	K516772	475
K106815	595	K516773	595
K107100	24700	K516776	475
K107168	475	K516780	635
K107552	EH239300	K518331	385
K108609	05000	K529695	395
K109413	48200		

The parts listed above are heavy section double cups and may have an unusual feature such as a flange. Refer to series for dimensional information.

**12**

NP and XC PARTS

CONE			Max Shaft Fillet Radii R <sup>1</sup>	CUP			Max Hs'ng Fillet Radii r <sup>1</sup>	Remarks
Number	BORE d	WIDTH B		Number	OUTSIDE DIA D	WIDTH C		
XC309C	227.076 8.9400	61.912 2.4375	7.0 .28					
*JXC332CA	48.000 1.8898	17.460 .6875	2.5 .10					JXC332CA: FRONTFACE CHAMFER
XC332C	46.038 1.8125	17.462 .6875	.8 .03	*XC332D	80.962 3.1875	14.288 .5625	spcl. spcl.	XC332D: SPECIAL RADIUS ON FRONTFACE OD SPECIAL RADIUS ON BACKFACE OD
XC407C	203.200 8.0000	88.897 3.4999	3.3 .13					
*XC758CA	63.500 2.5000	38.100 1.5000	3.5 .14					XC758CA: EXTENDED SMALL RIB GROOVE IN OD FRONTFACE
XC758CD	63.500 2.5000	36.170 1.4240	3.5 .14					
*XC941C	255.588 10.0625	22.225 .8750	1.5 .06	*XC941DB	296.862 11.6875	15.875 .6250	1.5 .06	XC941C: MADE FROM VACUUM MELT STEEL BROKEN FRONTFACE ID XC941DB: MADE FROM VACUUM MELT STEEL
XC974CC	34.976 1.3770	20.638 .8125	3.5 .14	XC974DB	71.966 2.8333	19.050 .7500	.8 .03	
*XC1190CG	215.900 8.5000	79.372 3.1249	1.5 .06					XC1190CG: NO SMALL RIB SHOULDER ON OD FRONTFACE
XC1196CBC	50.800 2.0000	26.909 1.0594	3.5 .14					
XC1219CP	177.800 7.0000	63.500 2.5000	7.0 .28					
XC1309CD	38.100 1.5000	16.520 .6504	.8 .03	XC1309DE	69.012 2.7170	15.083 .5938	1.5 .06	
				XC1310DF	85.400 3.3622	18.000 .7087	1.5 .06	
				*XC1362D	438.048 17.2460	123.825 4.8750	1.5 .06	XC1362D: HOLES IN OD CENTER GROOVE IN OD CENTER
XC1378CC	130.000 5.1181	47.625 1.8750	3.5 .14					
XC1410CA	234.823 9.2450	49.212 1.9375	1.5 .06	XC1410DA	320.675 12.6250	33.338 1.3125	3.3 .13	
				XC1475DB	100.000 3.9370	42.862 1.6875	.8 .03	
*XC1671CA	109.538 4.3125	21.438 .8440	3.5 .14					XC1671CA: MADE FROM VACUUM MELT STEEL
XC1671CC	109.538 4.3125	21.438 .8440	5.0 .20					
XC1671CCA	109.538 4.3125	21.438 .8440	5.0 .20	*XC1671DA	158.750 6.2500	15.875 .6250	3.3 .13	XC1671DA: MADE FROM VACUUM MELT STEEL
				*XC1753DE	161.925 6.3750	85.725 3.3750	1.5 .06	XC1753DE: GROOVE IN OD CENTER HOLES IN OD CENTER
XC1781CE	130.175 5.1250	123.825 4.8750	1.5 .06					
*XC1781CF	119.964 4.7230	47.625 1.8750	3.5 .14	XC1784DC	80.035 3.1510	19.845 .7813	.8 .03	XC1781CF: FRONTFACE CHAMFER
				XC1788DA	290.398 11.4330	42.862 1.6875	3.3 .13	
XC1836C	456.959 17.9905	73.025 2.8750	9.7 .38	*XC1836D	596.900 23.5000	120.650 4.7500	1.5 .06	XC1836D: GROOVE IN OD CENTER HOLES IN OD CENTER

\*\*These Maximum Fillet Radii will be cleared by the Cone or Cup Radii.  
\* See Remarks Column.

NP Parts are made for specific applications.  
XC Parts are in limited production.

13

NP and XC PARTS

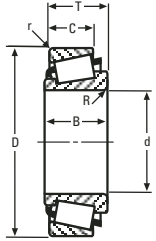

SINGLE ROW

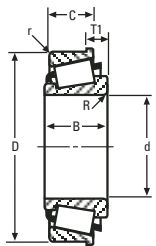

SINGLE ROW WITH FLANGE

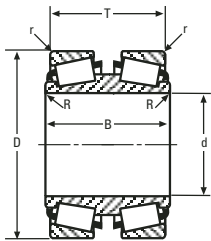

DOUBLE CONE

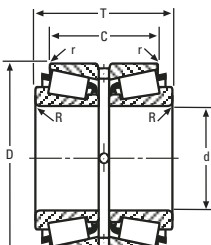

DOUBLE CUP

CONE			Max Shaft Fillet Radii R'	CUP			Max Hs'ng Fillet Radii r'	Remarks
Number	BORE d	WIDTH B		Number	OUTSIDE DIA D	WIDTH C		
JXC1839CL	55.000 2.1654	29.795 1.1730	1.5 .06					
*XC1850CA	228.600 9.0000	87.312 3.4375	10.5 .41					XC1850CA: SHOULDER ON OD FRONTFACE NO SMALL RIB
XC1850CB	234.950 9.2500	87.312 3.4375	10.5 .41					
XC1850CC	230.188 9.0625	87.312 3.4375	10.5 .41					
				XC1850DF	384.175 15.1250	63.500 2.5000	3.3 .13	
*XC1863CD	53.962 2.1245	23.973 .9438	1.5 .06					XC1863CD: MADE FROM VACUUM MELT STEEL GROOVE IN OD BACKFACE
XC1863CG	57.150 2.2500	18.258 .7188	1.5 .06					
				*XC1923DB	153.924 6.0600	43.655 1.7187	.8 .03	XC1923DB: ASYMMETRICAL - TWO SERIES BEARING HOLES IN RIGHTFACE FLANGE FLANGE ON OD RIGHTFACE
XC1931CC	88.900 3.5000	20.638 .8125	1.5 .06					
XC1933CH	107.950 4.2500	21.433 .8438	1.5 .06					
				XC1933DE	146.050 5.7500	16.670 .6563	1.5 .06	XC1934CB: MADE FROM VACUUM MELT STEEL
*XC1934CB	127.000 5.0000	26.195 1.0313	1.5 .06					JXC1945CA: BROKEN FRONTFACE ID
*JXC1945CA	100.000 3.9370	15.085 .5938	1.5 .06					JXC1945CB: BROKEN FRONTFACE ID
*JXC1945CB	100.000 3.9370	15.085 .5938	1.5 .06					JXC1945CC: BROKEN FRONTFACE ID
*JXC1945CC	98.000 3.8583	15.085 .5938	1.5 .06					
				JXC1945DA	130.000 5.1181	11.910 .4688	1.5 .06	XC1956CC: EXTENDED SMALL RIB
XC1948CA	127.000 5.0000	17.462 .6875	1.5 .06					
*XC1956CC	235.331 9.2650	57.150 2.2500	6.4 .25					
XC1962CE	29.987 1.1806	16.566 .6522	1.5 .06					
XC1966CA	68.262 2.6875	46.038 1.8125	3.5 .14					
*XC1970CF	57.150 2.2500	30.162 1.1875	3.5 .14					XC1970CF: FRONTFACE CHAMFER
				XC1970DC	112.712 4.4375	23.812 .9375	3.3 .13	XC1980CM: GROOVE IN OD FRONTFACE
*XC1980CM	60.325 2.3750	46.038 1.8125	3.5 .14					XC1980CN: GROOVE IN OD FRONTFACE
*XC1980CN	50.800 2.0000	46.038 1.8125	.8 .03					
				JXC1983DA	102.000 4.0157	33.340 1.3125	1.0 .04	
				XC2015DB	82.931 3.2650	17.813 .7013	1.5 .06	
				XC2023DC	146.050 5.7500	25.400 1.0000	3.3 .13	
XC2058CF	53.975 2.1250	32.791 1.2910	3.5 .14					
XC2064CB	133.350 5.2500	46.038 1.8125	3.5 .14					XC2064D: HOLES IN OD CENTER GROOVE IN OD CENTER
				*XC2064D	196.850 7.7500	85.725 3.3750	.8 .03	XC2081CB: SHOULDER ON ID FRONTFACE KEYWAY IN FRONTFACE TAPERED BORE SPECIAL BACKFACE RADIUS EXTENDED LARGE RIB
*XC2081CB	460.672 18.1367	206.438 8.1275	spcl. spcl.					
*XC2081CC	443.596 17.4644	258.763 10.1875	3.0 .12					
*XC2081CD	422.031 16.6154	119.062 4.6875	6.4 .25					

NP Parts are made for specific applications.  
XC Parts are in limited production.

\*\*These Maximum Fillet Radii will be cleared by the Cone or Cup Radii.  
\* See Remarks Column.

13

CONE			Max Shaft Fillet Radii R <sup>1</sup>	CUP			Max Hs'ng Fillet Radii r <sup>1</sup>	Remarks	
Number	BORE d	WIDTH B		Number	OUTSIDE DIA D	WIDTH C			
*XC2081CE	460.672 18.1367	206.438 8.1275	spcl. spcl.					XC2081CC: TQI/TQO (INTERLOCKING) TAPERED BORE	
*XC2081CF	443.596 17.4644	258.763 10.1875	3.0 .12					XC2081CD: KEYWAY IN FRONTFACE SHOULDER ON ID FRONTFACE REVERSE TAPERED BORE	
*XC2081CG	460.672 18.1367	206.438 8.1275	spcl. spcl.					XC2081CE: TAPERED BORE SPECIAL BACKFACE RADIUS KEYWAY IN FRONTFACE EXTENDED LARGE RIB SHOULDER ON ID FRONTFACE	
*XC2081CH	422.031 16.6154	119.062 4.6875	6.4 .25						
XC2081CR	447.675 17.6250	120.650 4.7500	6.4 .25						
*XC2094CB	346.075 13.6250	95.250 3.7500	6.4 .25						
XC2097C	171.450 6.7500	47.625 1.8750	3.5 .14						
				XC2099DD	136.525 5.3750	46.038 1.8125	3.3 .13		XC2081CF: TQI/TQO (INTERLOCKING) TAPERED BORE
				*XC2105DA	107.950 4.2500	53.975 2.1250	.8 .03		XC2081CG: EXTENDED LARGE RIB SPECIAL BACKFACE RADIUS TAPERED BORE
XC2113CB	48.412 1.9060	36.512 1.4375	3.5 .14						
				XC2113DA	107.988 4.2515	28.575 1.1250	3.3 .13		XC2081CH: REVERSE TAPERED BORE
				*XC2113DC	109.398 4.3070	53.975 2.1250	.8 .03		XC2094CB: NO SMALL RIB SHOULDER ON OD FRONTFACE GROOVE IN OD FRONTFACE
XC2131CE	203.200 8.0000	49.212 1.9375	3.5 .14						
				XC2131D	279.527 11.0050	36.512 1.4375	3.3 .13		XC2105DA: HOLES IN OD CENTER
				*XC2133DC	127.000 5.0000	26.988 1.0625	3.3 .13		XC2113DC: KEYWAY IN OD RIGHTFACE CHAMFER ON RIGHTFACE OD ASYMMETRICAL - TWO SERIES BEARING FLANGE ON OD LEFTFACE GROOVE IN OD LEFTFACE
*XC2141C	419.100 16.5000	22.225 .8750	spcl. spcl.						
				XC2141D	476.250 18.7500	20.625 .8120	1.5 .06		
				XC2143D	238.125 9.3750	50.800 2.0000	6.4 .25		XC2133DC: CHAMFER ON FRONTFACE OD FLANGE ON OD FRONTFACE, BEARING WIDTH IS T1 DIMENSION
XC2149C	673.100 26.5000	61.912 2.4375	6.4 .25						
XC2159CA	114.236 4.4975	41.275 1.6250	3.5 .14						
				*XC2175D	698.500 27.5000	76.200 3.0000	3.3 .13		XC02139DE: GROOVE IN OD FRONTFACE
				XC2179DB	266.751 10.5020	38.100 1.5000	3.3 .13		XC2141C: BACKFACE CHAMFER FRONTFACE CHAMFER
*XC2180CD	355.486 13.9955	60.325 2.3750	3.5 .14						
*JXC2188CU	45.000 1.7717	22.500 .8858	3.0 .13						
*JXC2188CV	45.000 1.7717	22.500 .8858	3.0 .13						
XC2192C	336.550 13.2500	23.812 .9375	3.5 .14						
				XC2192D	381.000 15.0000	19.050 .7500	3.3 .13		JXC2188CU: FRONTFACE CHAMFER JXC2188CV: FRONTFACE CHAMFER
JXC2195CH	24.990 .9838	20.640 .8125	.8 .03						
*JXC2195CM	29.985 1.1805	21.000 .8268	spcl. spcl.						
				JXC2195DD	63.015 2.4809	21.000 .8268	2.3 .09		JXC2195CM: SPECIAL BACKFACE RADIUS
XC2195CF	31.750 1.2500	20.638 .8125	.8 .03						
XC2195CG	25.400 1.0000	20.638 .8125	.8 .03						
XC2195CJ	25.400 1.0000	20.640 .8125	.8 .03						

\*These Maximum Fillet Radii will be cleared by the Cone or Cup Radii.  
• See Remarks Column.

NP Parts are made for specific applications.  
XC Parts are in limited production.

NP and XC PARTS

CONE			Max Shaft Fillet Radii R'	CUP			Max Hs'ng Fillet Radii r'	Remarks
Number	BORE d	WIDTH B		Number	OUTSIDE DIA D	WIDTH C		
				*XC2195DA	62.000 2.4409	14.288 .5625	1.3 .05	XC2195DA: MADE FROM VACUUM MELT STEEL
				XC2195DC	62.000 2.4409	14.288 .5625	1.3 .05	
				*XC2204D	270.002 10.6300	93.662 3.6875	1.5 .06	XC2204C: SLOTS IN RIGHTFACE SHOULDER ON OD LEFTFACE
				XC2204DA	269.875 10.6250	42.862 1.6875	3.3 .13	XC2204D: HOLES IN OD CENTER GROOVE IN OD CENTER
				*XC2213D	876.300 34.5000	73.025 2.8750	1.5 .06	XC2213D: HOLES IN FRONTFACE
				XC2228DD	488.950 19.2500	74.612 2.9375	3.3 .13	
				*XC2243C	50.800 2.0000	27.780 1.0937	2.8 .11	XC2243C: NO SMALL RIB NO LARGE RIB
				*XC2243CB	50.800 2.0000	27.780 1.0937	2.8 .11	XC2243CB: NO SMALL RIB NO LARGE RIB STRAIGHT OD
				XC2251C	303.075 11.9321	263.525 10.3750	3.3 .13	
				*XC2253CB	34.925 1.3750	18.288 .7200	spcl. spcl.	XC2253CB: SPECIAL BACKFACE RADIUS
				*XC2268CG	330.200 13.0000	47.625 1.8750	3.5 .14	XC2268CG: MADE FROM SPECIAL STEEL
				XC2268CK	330.200 13.0000	47.625 1.8750	3.5 .14	
				*XC2268D	415.925 16.3750	34.925 1.3750	3.3 .13	XC2268D: MADE FROM SPECIAL STEEL
				XC2268DB	415.925 16.3750	34.925 1.3750	3.3 .13	
				*XC2275C	36.512 1.4375	20.638 .8125	1.5 .06	XC2275C: NO SMALL RIB NO LARGE RIB
				XC2275D	79.375 3.1250	23.812 .9375	1.6 .06	
				XC2277D	169.062 6.6560	41.275 1.6250	3.3 .13	
				XC2279CA	60.325 2.3750	25.400 1.0000	3.5 .14	
				XC2279CE	62.738 2.4700	25.400 1.0000	3.5 .14	
				XC2283C	228.549 8.9980	69.850 2.7500	6.4 .25	XC2279DB: HOLES IN OD CENTER
				XC2287CD	44.988 1.7712	31.750 1.2500	2.5 .10	XC2283DA: GROOVE IN OD CENTER HOLES IN OD CENTER
				XC2305CA	457.200 18.0000	130.175 5.1250	1.5 .06	
				XC2312CC	63.500 2.5000	41.275 1.6250	3.5 .14	

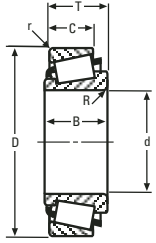

SINGLE ROW



SINGLE ROW WITH FLANGE

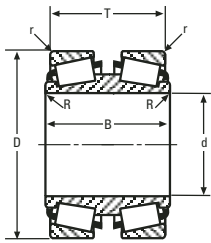

DOUBLE CONE

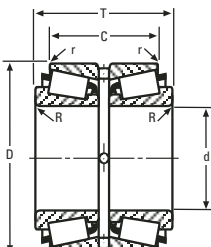

DOUBLE CUP

13

NP Parts are made for specific applications.  
XC Parts are in limited production.

\*\*These Maximum Fillet Radii will be cleared by the Cone or Cup Radii.  
\* See Remarks Column.



NP and XC PARTS

CONE			Max Shaft Fillet Radii R <sup>1</sup>	CUP			Max Hs'ng Fillet Radii r <sup>1</sup>	Remarks
Number	BORE d	WIDTH B		Number	OUTSIDE DIA D	WIDTH C		
XC2313CE	228.600	69.850	6.8	XC2312D	139.700	31.750	3.3	
	9.0000	2.7500			5.5000	1.2500		
XC2328CC	50.800	30.162	.8	XC2321DK	152.425	30.162	3.3	
	2.0000	1.1875			6.0010	1.1875		
XC2328CK	49.967	30.162	3.5					
	1.9672	1.1875	.14					
XC2332CC	57.150	44.450	3.5					
	2.2500	1.7500	.14					
XC2332CD	60.325	44.450	3.5					
	2.3750	1.7500	.14					
*XC2332CE	50.800	44.450	3.5					XC2332CE: HOLES IN BACKFACE TO UNDERCUT
	2.0000	1.7500	.14					
XC2332CF	60.325	44.450	3.5					
	2.3750	1.7500	.14					
				*XC2338DA	220.662	163.510	N/A	XC2338DA: HOLES IN OD CENTER
					8.6875	6.4374	N/A	
				*XC2338DB	220.662	163.510	N/A	XC2338DB: HOLES IN OD CENTER
					8.6875	6.4374	N/A	
XC2341CE	19.050	11.153	1.0					
	.7500	.4391	.04					
				*XC2341DA	41.275	26.988	1.8	XC2341DA: CHAMFER ON LEFTFACE OD
					1.6250	1.0625	.07	CHAMFER ON RIGHTFACE OD
JXC2347CG	17.000	14.605	1.0					
	.6693	.5750	.04					
				JXC2347DH	40.000	10.075	1.3	
					1.5748	.3967	.05	
XC2347CA	16.980	14.605	1.2					
	.6685	.5750	.05					
				XC2347DE	39.975	10.668	1.3	
					1.5738	.4200	.05	
				XC2347DF	39.878	50.800	.4	
					1.5700	2.0000	.01	
				XC2359DF	64.292	16.670	1.5	
					2.5312	.6563	.06	
				XC2359DG	64.292	16.670	1.5	
					2.5312	.6563	.06	
				XC2366D	90.863	15.875	2.0	
					3.5773	.6250	.08	
*JXC2368CA	100.000	30.000	2.3					JXC2368CA: HOLES IN BACKFACE TO UNDERCUT
	3.9370	1.1811	.09					
*XC2376C	50.800	64.447	.8					XC2376C: EXTENDED SMALL RIB
	2.0000	2.5373	.03					
*XC2376CA	49.212	64.447	.8					XC2376CA: EXTENDED SMALL RIB
	1.9375	2.5373	.03					
*XC2376CB	47.625	64.447	.8					XC2376CB: EXTENDED SMALL RIB
	1.8750	2.5373	.03					
*XC2376CC	53.975	64.447	.8					XC2376CC: EXTENDED SMALL RIB
	2.1250	2.5373	.03					
*XC2376CQ	57.150	23.945	.8					XC2376CQ: HOLES IN BACKFACE TO UNDERCUT
	2.2500	.9427	.03					
				XC2376DC	100.100	17.826	.8	
					3.9410	.7018	.03	
				XC2376DE	100.863	17.826	2.0	
					3.9710	.7018	.08	
XC2378C	55.562	66.053	.8					
	2.1875	2.6005	.03					
XC2378CD	59.987	22.000	2.3					
	2.3617	.8661	.09					
XC2378CE	59.987	22.000	2.3					
	2.3617	.8661	.09					
				XC2378D	104.775	15.875	2.0	
					4.1250	.6250	.08	

\*\*These Maximum Fillet Radii will be cleared by the Cone or Cup Radii.  
\* See Remarks Column.

NP Parts are made for specific applications.  
XC Parts are in limited production.

**NP and XC PARTS**

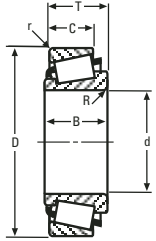

**SINGLE ROW**

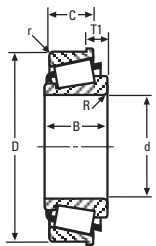

**SINGLE ROW WITH FLANGE**

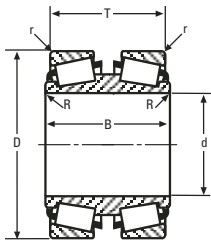

**DOUBLE CONE**

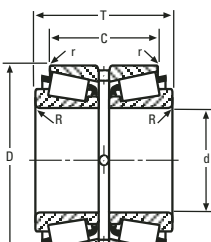

**DOUBLE CUP**

**13**

CONE			Max Shaft Fillet Radii R'	CUP			Max Hs'ng Fillet Radii r'	Remarks
Number	BORE d	WIDTH B		Number	OUTSIDE DIA D	WIDTH C		
*XC2379C	74.612 2.9375	69.215 2.7250	.8 .03					XC2379C: ECCENTRIC RIB BEARING
*XC2379CA	69.850 2.7500	69.215 2.7250	.8 .03					XC2379CA: ECCENTRIC RIB BEARING
*XC2379CB	68.262 2.6875	69.215 2.7250	.8 .03					XC2379CB: ECCENTRIC RIB BEARING
*XC2379CD	77.788 3.0625	23.012 .9060	3.5 .14					XC2379CD: FRONTFACE CHAMFER
XC2380C	38.100 1.5000	58.905 2.3191	.8 .03	XC2379DA	121.442 4.7812	17.462 .6875	2.0 .08	
XC2380CA	36.512 1.4375	58.905 2.3191	.8 .03					
*XC2380CB	41.275 1.6250	24.166 .9514	3.5 .14					XC2380CB: EXTENDED SMALL RIB
*XC2381C	44.450 1.7500	58.890 2.3185	.8 .03	XC2380D	73.431 2.8910	14.732 .5800	.8 .03	
*XC2381CA	42.862 1.6875	58.890 2.3185	.8 .03					XC2381C: EXTENDED SMALL RIB
*XC2381CB	41.275 1.6250	58.890 2.3185	.8 .03					XC2381CA: EXTENDED SMALL RIB
XC2382C	34.925 1.3750	58.903 2.3190	.8 .03					XC2381CB: EXTENDED SMALL RIB
XC2382CA	31.750 1.2500	58.903 2.3190	.8 .03					
XC2382CB	30.162 1.1875	58.903 2.3190	.8 .03					
*XC2383C	88.900 3.5000	82.710 3.2563	.8 .03					XC2382C: EXTENDED SMALL RIB
XC2383CA	87.312 3.4375	82.710 3.2563	.8 .03					XC2383C: EXTENDED SMALL RIB
XC2384C	80.962 3.1875	81.915 3.2250	.8 .03					
XC2384CA	76.200 3.0000	81.915 3.2250	.8 .03					
XC2384CL	85.725 3.3750	29.769 1.1720	3.5 .14					
XC2385C	101.600 4.0000	97.790 3.8500	.8 .03					
XC2385CA	100.012 3.9375	97.790 3.8500	.8 .03					
XC2385CE	109.962 4.3292	34.925 1.3750	3.5 .14					
XC2391CA	228.346 8.9900	85.725 3.3750	6.4 .25					
XC2391CB	228.168 8.9830	85.725 3.3750	6.4 .25					
XC2394C	107.950 4.2500	36.512 1.4375	3.5 .14					
XC2398CA	53.975 2.1250	19.050 .7500	2.3 .09	XC2394DA	165.100 6.5000	26.988 1.0625	3.3 .13	
XC2399CA	125.412 4.9375	110.490 4.3500	.8 .03					
XC2399CD	136.525 5.3750	39.688 1.5625	10.0 .39					
*XC2405CC	36.987 1.4562	22.710 .8941	1.5 .06					XC2398CA: EXTENDED SMALL RIB
*XC2405CF	38.100 1.5000	20.015 .7880	2.3 .09					XC2399CA: EXTENDED SMALL RIB
*XC2405CH	38.100 1.5000	20.051 .7894	2.0 .08					XC2399CD: EXTENDED SMALL RIB

NP Parts are made for specific applications.  
XC Parts are in limited production.

\*\*These Maximum Fillet Radii will be cleared by the Cone or Cup Radii.  
\* See Remarks Column.

NP and XC PARTS

CONE			Max Shaft Fillet Radii R <sup>1</sup>	CUP			Max Hs'ng Fillet Radii r <sup>1</sup>	Remarks
Number	BORE d	WIDTH B		Number	OUTSIDE DIA D	WIDTH C		
XC2405CJ	35.000 1.3780	18.290 .7200	2.3 .09					XC2405CK: FRONTFACE CHAMFER
*XC2405CK	38.100 1.5000	18.288 .7200	2.3 .09					
				XC2405DC	69.974 2.7549	18.435 .7258	2.5 .10	
				XC2405DE	65.088 2.5625	14.986 .5900	1.3 .05	
				XC2405DG	65.088 2.5625	13.970 .5500	1.3 .05	
				XC2405DH	69.088 2.7200	15.748 .6200	1.3 .05	
				XC2405DK	65.088 2.5625	13.970 .5500	1.3 .05	
JXC2409CC	85.000 3.3465	40.250 1.5846	3.0 .12	JXC2409D	150.000 5.9055	31.750 1.2500	3.0 .12	
XC2409CB	69.850 2.7500	41.275 1.6250	3.5 .14					
XC2411CA	17.462 .6875	14.605 .5750	1.3 .05	XC2411D	39.878 1.5700	10.668 .4200	1.3 .05	
XC2414CD	34.925 1.3750	25.400 1.0000	1.0 .04	*JXC2424DA	100.000 3.9370	42.000 1.6535	N/A N/A	JXC2424DA: ASYMMETRICAL - TWO SERIES BEARING FLANGE ON OD LEFTFACE
				XC2431DC	120.000 4.7244	19.050 .7500	2.3 .09	
XC2437CE	44.450 1.7500	28.575 1.1250	3.5 .14					
XC2437CF	44.450 1.7500	28.575 1.1250	3.5 .14					
*XC2438C	66.675 2.6250	57.150 2.2500	3.5 .14					XC2438C: GROOVE IN OD FRONTFACE SHOULDER ON OD FRONTFACE
*XC2438CB	66.675 2.6250	57.150 2.2500	1.5 .06	*XC2438D	152.400 6.0000	41.275 1.6250	3.3 .13	XC2438CB: HOLES IN ID BACKFACE MADE FROM VACUUM MELT STEEL SHOULDER ON ID BACKFACE
				XC2443D	673.100 26.5000	419.100 16.5000	3.3 .13	GROOVE IN ID BACKFACE
*XC2447C	669.671 26.3650	185.864 7.3175	9.7 .38					XC2438D: MADE FROM VACUUM MELT STEEL
*XC2447CA	654.360 25.7622	347.662 13.6875	4.8 .19					XC2447C: TAPERED BORE
*XC2447CB	625.389 24.6216	188.912 7.4375	9.7 .38					XC2447CA: ASYMMETRICAL BEARING TAPERED BORE
*XC2447CH	625.132 24.6115	191.033 7.5210	9.7 .38					XC2447CB: REVERSE TAPERED BORE
*XC2450CA	501.650 19.7500	250.825 9.8750	3.3 .13	*XC2450DA	711.200 28.0000	106.362 4.1875	6.4 .25	XC2447CH: REVERSE TAPERED BORE
*XC2451C	828.675 32.6250	214.312 8.4375	9.7 .38					XC2450CA: TAPERED BORE MADE FROM SPECIAL STEEL
*XC2451CA	810.994 31.9289	396.875 15.6250	4.8 .19					XC2450DA: MADE FROM SPECIAL STEEL
*XC2451CB	777.921 30.6268	214.312 8.4375	9.7 .38					XC2451C: KEYWAY IN FRONTFACE TAPERED BORE
*XC2451CF	828.777 32.6290	214.312 8.4375	9.7 .38					XC2451CA: TAPERED BORE TQI/TQO (NON-INTERLOCKING)
*XC2451CG	810.918 31.9259	396.875 15.6250	4.8 .19					
*XC2451CH	777.844 30.6238	214.312 8.4375	9.7 .38					XC2451CB: REVERSE TAPERED BORE

\*\*These Maximum Fillet Radii will be cleared by the Cone or Cup Radii.  
\* See Remarks Column.

NP Parts are made for specific applications.  
XC Parts are in limited production.

NP and XC PARTS

CONE			Max Shaft Fillet Radii R'	CUP			Max Hs'ng Fillet Radii r'	Remarks
Number	BORE d	WIDTH B		Number	OUTSIDE DIA D	WIDTH C		
*XC2455CF	120.650 4.7500	52.388 2.0625	.5 .02					XC2451CF: KEYWAY IN FRONTFACE TAPERED BORE
				XC2456D	190.525 7.5010	34.925 1.3750	1.5 .06	XC2451CG: TQI/TQO (NON-INTERLOCKING) REVERSE TAPERED BORE
*XC2463CL	827.527 32.5798	171.450 6.7500	9.7 .38					XC2451CH: REVERSE TAPERED BORE KEYWAY IN FRONTFACE
*XC2463CN	872.769 34.3610	171.450 6.7500	9.7 .38					XC2455CF: GROOVE IN OD BACKFACE BROKEN FRONTFACE ID SHOULDER ON OD BACKFACE EXTENDED LARGE RIB
*XC2465CC	34.988 1.3775	17.000 .6693	spcl. spcl.	XC2465DD	61.973 2.4399	13.600 .5354	1.5 .06	XC2463CL: REVERSE TAPERED BORE
*XC2475C	777.875 30.6250	219.075 8.6250	9.7 .38					XC2463CN: TAPERED BORE
*XC2475CA	759.618 29.9062	406.400 16.0000	4.8 .19	*XC2477D	736.600 29.0000	177.800 7.0000	1.5 .06	XC2465CC: FRONTFACE CHAMFER SPECIAL BACKFACE RADIUS
*XC2475CB	725.752 28.5729	219.075 8.6250	9.7 .38	*XC2477DA	736.600 29.0000	177.800 7.0000	1.5 .06	XC2475C: TAPERED BORE KEYWAY IN FRONTFACE
								XC2475CA: TAPERED BORE KEYWAY IN FRONTFACE
				*XC2480D	314.782 12.3930	106.362 4.1875	1.5 .06	XC2475CB: REVERSE TAPERED BORE KEYWAY IN FRONTFACE
				*XC2481DA	73.025 2.8750	38.892 1.5312	1.5 .06	XC2477D: GROOVE IN OD CENTER HOLES IN OD CENTER
				*XC2481DB	73.414 2.8903	38.892 1.5312	1.5 .06	XC2477DA: HOLES IN OD CENTER GROOVE IN OD CENTER
				XC2488DA	122.238 4.8125	38.100 1.5000	3.3 .13	XC2480D: GROOVE IN OD CENTER HOLES IN OD CENTER
*JXC2493CA	120.000 4.7244	36.000 1.4173	3.5 .14					XC2481DA: SHOULDER ON OD FRONTFACE GROOVE IN ID CENTER
XC2527CB	95.000 3.7402	45.500 1.7913	5.0 .20	JXC2568DA	100.000 3.9370	23.020 .9063	3.3 .13	XC2481DB: GROOVE IN ID CENTER SHOULDER ON OD FRONTFACE
								JXC2493CA: HOLES IN BACKFACE TO UNDERCUT
*XC2836C	604.838 23.8125	109.538 4.3125	6.4 .25	XC2837D	123.825 4.8750	25.400 1.0000	3.3 .13	XC2836C: TAPERED BORE KEYWAY IN FRONTFACE
*XC2836CA	595.709 23.4531	201.612 7.9375	3.3 .13	XC2840D	62.000 2.4409	15.500 .6102	1.5 .06	XC2836CA: TAPERED BORE TQI/TQO (NON-INTERLOCKING)
*XC2836CB	578.909 22.7917	109.538 4.3125	6.4 .25	XC5240D	358.775 14.1250	23.812 .9375	3.3 .13	XC2836CB: KEYWAY IN FRONTFACE REVERSE TAPERED BORE
XC2837CT	53.975 2.1250	32.791 1.2910	3.5 .14					XC5939CA: MADE FROM SPECIAL STEEL
				*XC5939D	457.098 17.9960	49.212 1.9375	3.3 .13	XC5939D: MADE FROM SPECIAL STEEL
				XC5939DB	457.098 17.9960	49.212 1.9375	3.3 .13	
				XC5940D	336.550 13.2500	50.800 2.0000	3.3 .13	

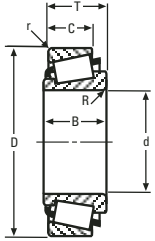

SINGLE ROW



SINGLE ROW WITH FLANGE

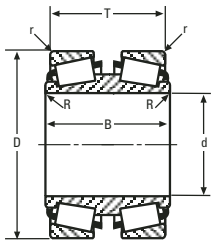

DOUBLE CONE

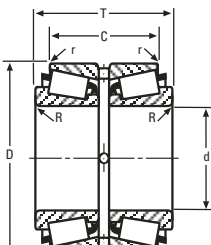

DOUBLE CUP

13

NP Parts are made for specific applications.  
XC Parts are in limited production.

\*These Maximum Fillet Radii will be cleared by the Cone or Cup Radii.  
\* See Remarks Column.

NP and XC PARTS

CONE			Max Shaft Fillet Radii R <sup>1</sup>	CUP			Max Hs'ng Fillet Radii r <sup>1</sup>	Remarks
Number	BORE d	WIDTH B		Number	OUTSIDE DIA D	WIDTH C		
*XC6838C	42.875 1.6880	25.392 .9997	spcl. spcl.					XC6838C: SPECIAL BACKFACE RADIUS
				XC6838D	80.962 3.1875	18.550 .7303	2.3 .09	
*JXC6839CD	28.000 1.1024	32.000 1.2598	2.5 .10					JXC6839CD: FRONTFACE CHAMFER
				*JXC6839DC	95.000 3.7402	26.500 1.0433	1.5 .06	JXC6839DC: BROKEN CORNER ON FRONTFACE OD FLANGE ON OD FRONTFACE, BEARING WIDTH IS T1 DIMENSION
*XC6839CC	39.987 1.5743	32.000 1.2598	1.0 .04					
				XC6840DA	136.525 5.3750	34.000 1.3386	3.3 .13	XC6839CC: FRONTFACE CHAMFER
XC8240C	558.800 22.0000	88.108 3.4688	6.4 .25					
				XC8240D	736.600 29.0000	63.500 2.5000	6.4 .25	
*XC8439C	547.535 21.5565	153.746 6.0530	6.4 .25					XC8439C: KEYWAY IN FRONTFACE TAPERED BORE
*XC8439CA	534.800 21.0551	288.925 11.3750	3.3 .13					XC8439CA: TQI/TQO (NON-INTERLOCKING) TAPERED BORE
*XC8439CB	510.800 20.1102	155.575 6.1250	6.4 .25					
*XC8439CC	555.234 21.8596	233.416 9.1896	spcl. spcl.					XC8439CB: HOLES IN BACKFACE REVERSE TAPERED BORE
*XC8439CD	509.588 20.0625	142.875 5.6250	6.4 .25					XC8439CC: EXTENDED SMALL RIB TAPERED BORE SPECIAL BACKFACE RADIUS
*XC8640CC	99.974 3.9360	42.000 1.6535	3.0 .12					
*XC8640CD	99.974 3.9360	42.000 1.6535	spcl. spcl.					XC8439CD: REVERSE TAPERED BORE
*XC9436CA	279.400 11.0000	24.384 .9600	1.5 .06					XC8640CC: FRONTFACE CHAMFER
				*XC9436D	317.500 12.5000	18.288 .7200	1.5 .06	XC8640CD: SPECIAL BACKFACE RADIUS FRONTFACE CHAMFER
				*XC02139DE	90.000 3.5433	21.500 .8465	3.0 .12	
				XC02139DF	82.000 3.2283	21.500 .8465	1.3 .05	XC9436CA: MADE FROM SPECIAL STEEL
				XC02139DT	82.652 3.2540	16.510 .6500	.8 .03	XC9436D: MADE FROM SPECIAL STEEL
				XC02139DU	83.414 3.2840	16.510 .6500	1.3 .05	
*XC02634CE	415.925 16.3750	209.550 8.2500	3.3 .13					XC02634CE: GROOVE IN ID CENTER MADE FROM SPECIAL STEEL TAPERED BORE
*XC02634CL	415.925 16.3750	209.550 8.2500	3.3 .13					
				*XC02634DC	590.550 23.2500	88.900 3.5000	6.4 .25	XC02634CL: GROOVE IN ID CENTER TAPERED BORE
				XC02634DH	590.550 23.2500	88.900 3.5000	6.4 .25	XC02634DC: MADE FROM SPECIAL STEEL
*XC03636CA	129.974 5.1171	86.248 3.3956	3.3 .13					
				XC04138D	193.675 7.6250	23.020 .9063	.3 .01	XC03636CA: SLOTS IN FRONTFACE SHOULDER ON OD BACKFACE FRONTFACE CHAMFER
				*JXC06536DC	45.000 1.7717	12.065 .4750	spcl. spcl.	JXC06536DC: FLANGE ON OD FRONTFACE, BEARING WIDTH IS T1 DIMENSION SPECIAL RADIUS ON BACKFACE OD
XC06536CD	21.986 .8656	16.637 .6550	1.3 .05					
*JXC07537CC	35.000 1.3780	18.460 .7268	2.0 .08					
*XC09636CA	368.300 14.5000	185.738 7.3125	3.3 .13					JXC07537CC: EXTENDED SMALL RIB
				XC09636DA	523.875 20.6250	79.375 3.1250	6.4 .25	XC09636CA: TAPERED BORE GROOVE IN ID CENTER
XC09637CD	41.275 1.6250	25.654 1.0100	3.5 .14					

<sup>1</sup>These Maximum Fillet Radii will be cleared by the Cone or Cup Radii.  
\* See Remarks Column.

NP Parts are made for specific applications.  
XC Parts are in limited production.

NP and XC PARTS

CONE			Max Shaft Fillet Radii R'	CUP			Max Hs'ng Fillet Radii r'	Remarks
Number	BORE d	WIDTH B		Number	OUTSIDE DIA D	WIDTH C		
				<b>XC09639DF</b>	<b>46.960</b> 1.8488	<b>12.065</b> .4750	<b>1.3</b> .05	
<b>*XC10036CB</b>	<b>85.000</b> 3.3465	<b>52.761</b> 2.0772	<b>3.5</b> .14					XC10036CB: SHOULDER ON OD FRONTFACE NO SMALL RIB
<b>*XC10037C</b>	<b>155.575</b> 6.1250	<b>122.238</b> 4.8125	<b>1.5</b> .06					XC10037C: ASYMMETRICAL BEARING MADE FROM SPECIAL STEEL TAPERED BORE
				<b>XC10037D</b>	<b>247.650</b> 9.7500	<b>52.388</b> 2.0625	<b>3.3</b> .13	
<b>XC10038C</b>	<b>110.500</b> 4.3504	<b>21.000</b> .8268	<b>1.5</b> .06					
<b>XC10038CA</b>	<b>110.500</b> 4.3504	<b>21.000</b> .8268	<b>1.5</b> .06					
<b>*JXC10040CC</b>	<b>80.000</b> 3.1496	<b>38.000</b> 1.4961	<b>3.0</b> .12					JXC10040CC: EXTENDED SMALL RIB GROOVE IN OD FRONTFACE
<b>*XC10040CB</b>	<b>84.000</b> 3.3071	<b>29.000</b> 1.1417	<b>3.0</b> .12					XC10040CB: MADE FROM VACUUM MELT STEEL
				<b>*XC10040DA</b>	<b>130.000</b> 5.1181	<b>24.000</b> .9449	<b>2.5</b> .10	
<b>*XC10237CA</b>	<b>98.000</b> 3.8583	<b>40.000</b> 1.5748	<b>1.7</b> .07					XC10040DA: MADE FROM VACUUM MELT STEEL
<b>XC10237CC</b>	<b>89.944</b> 3.5411	<b>43.500</b> 1.7126	<b>1.5</b> .06					XC10237CA: TAPERED BORE
<b>*XC10237CD</b>	<b>89.974</b> 3.5423	<b>47.000</b> 1.8504	<b>7.0</b> .28					XC10237CD: EXTENDED SMALL RIB
<b>*XC10237CH</b>	<b>89.974</b> 3.5423	<b>40.000</b> 1.5748	<b>5.8</b> .23					XC10237CH: FRONTFACE CHAMFER
				<b>XC10237DC</b>	<b>146.975</b> 5.7864	<b>32.500</b> 1.2795	<b>3.5</b> .14	
<b>*JXC10238CK</b>	<b>46.015</b> 1.8117	<b>18.000</b> .7087	spcl. spcl.					JXC10238CK: SPECIAL BACKFACE RADIUS FRONTFACE CHAMFER
				<b>JXC10238DF</b>	<b>75.000</b> 2.9528	<b>14.000</b> .5512	<b>1.5</b> .06	
<b>*XC10238CB</b>	<b>44.988</b> 1.7712	<b>19.093</b> .7517	spcl. spcl.					XC10238CB: SPECIAL BACKFACE RADIUS
				<b>XC10238DC</b>	<b>74.976</b> 2.9518	<b>14.000</b> .5512	<b>1.5</b> .06	
<b>XC10240CJ</b>	<b>29.000</b> 1.1417	<b>14.730</b> .5800	<b>3.5</b> .14					
<b>*XC10638C</b>	<b>184.150</b> 7.2500	<b>26.543</b> 1.0450	<b>1.5</b> .06					XC10238DC: EXTENDED SMALL RIB
<b>*XC10638CA</b>	<b>190.500</b> 7.5000	<b>26.543</b> 1.0450	<b>1.5</b> .06					XC10237CH: FRONTFACE CHAMFER
				<b>XC10638D</b>	<b>260.350</b> 10.2500	<b>28.829</b> 1.1350	<b>.3</b> .01	
<b>*XC10639C</b>	<b>209.550</b> 8.2500	<b>31.750</b> 1.2500	<b>1.5</b> .06					XC10238CK: SPECIAL BACKFACE RADIUS FRONTFACE CHAMFER
<b>*XC10639CA</b>	<b>215.900</b> 8.5000	<b>31.750</b> 1.2500	<b>1.5</b> .06					XC10238CB: SPECIAL BACKFACE RADIUS
				<b>XC10639D</b>	<b>295.275</b> 11.6250	<b>34.925</b> 1.3750	<b>.3</b> .01	
<b>*XC10740C</b>	<b>149.974</b> 5.9045	<b>77.788</b> 3.0625	<b>2.0</b> .08					XC10638C: NO SMALL RIB NO LARGE RIB
				<b>*XC10740D</b>	<b>276.300</b> 10.8780	<b>177.800</b> 7.0000	<b>N/A</b> N/A	
<b>XC10836CG</b>	<b>29.975</b> 1.1801	<b>16.764</b> .6600	<b>.8</b> .03					XC10638CA: NO SMALL RIB NO LARGE RIB
<b>XC10836CU</b>	<b>25.400</b> 1.0000	<b>16.231</b> .6390	<b>.8</b> .03					XC10639C: NO SMALL RIB NO LARGE RIB
				<b>*XC11087DA</b>	<b>82.931</b> 3.2650	<b>22.258</b> .8763	<b>.8</b> .03	
				<b>XC11087DL</b>	<b>80.035</b> 3.1510	<b>19.759</b> .7779	<b>1.5</b> .06	
				<b>XC11087DN</b>	<b>83.033</b> 3.2690	<b>19.050</b> .7500	<b>.8</b> .03	

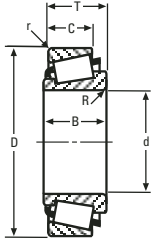

SINGLE ROW

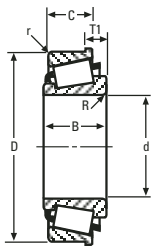

SINGLE ROW WITH FLANGE

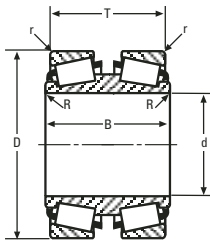

DOUBLE CONE

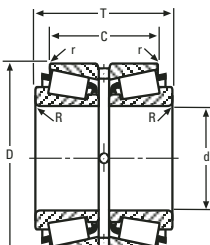

DOUBLE CUP

13

NP Parts are made for specific applications.  
XC Parts are in limited production.

\*\*These Maximum Fillet Radii will be cleared by the Cone or Cup Radii.  
\* See Remarks Column.

NP and XC PARTS

CONE			Max Shaft Fillet Radii R <sup>1</sup>	CUP			Max Hs'ng Fillet Radii r <sup>1</sup>	Remarks
Number	BORE d	WIDTH B		Number	OUTSIDE DIA D	WIDTH C		
				<b>XC11087DP</b>	<b>83.795</b> 3.2990	<b>19.050</b> .7500	<b>.8</b> .03	
<b>*XC11088CC</b>	<b>40.988</b> 1.6137	<b>18.000</b> .7087	spcl. spcl.	<b>XC11088D</b>	<b>67.975</b> 2.6762	<b>13.500</b> .5315	<b>1.5</b> .06	
<b>*JXC11438CA</b>	<b>183.000</b> 7.2047	<b>42.000</b> 1.6535	<b>1.0</b> .04	<b>JXC11438DA</b>	<b>260.000</b> 10.2362	<b>38.000</b> 1.4961	<b>3.5</b> .14	JXC11438CA: MADE FROM SPECIAL STEEL GROOVE IN ID BACKFACE SHOULDER ON ID BACKFACE
<b>*XC11438C</b>	<b>182.974</b> 7.2037	<b>42.000</b> 1.6535	<b>1.0</b> .04	<b>XC11438D</b>	<b>259.974</b> 10.2352	<b>38.000</b> 1.4961	<b>3.5</b> .14	XC11438C: GROOVE IN ID BACKFACE SHOULDER ON ID BACKFACE
<b>*JXC11439CA</b>	<b>140.000</b> 5.5118	<b>55.000</b> 2.1654	<b>1.0</b> .04	<b>JXC11439DA</b>	<b>219.000</b> 8.6220	<b>48.000</b> 1.8898	<b>3.5</b> .14	JXC11439CA: GROOVE IN ID BACKFACE SHOULDER ON ID BACKFACE
<b>*XC11439C</b>	<b>139.974</b> 5.5108	<b>55.000</b> 2.1654	<b>1.0</b> .04	<b>XC11439D</b>	<b>218.973</b> 8.6210	<b>48.000</b> 1.8898	<b>3.5</b> .14	XC11439C: SHOULDER ON ID BACKFACE GROOVE IN ID BACKFACE
<b>*JXC11440CA</b>	<b>138.000</b> 5.4331	<b>42.000</b> 1.6535	<b>1.0</b> .04	<b>JXC11440DA</b>	<b>205.000</b> 8.0709	<b>38.000</b> 1.4961	<b>3.5</b> .14	JXC11440CA: SHOULDER ON ID BACKFACE GROOVE IN ID BACKFACE
<b>*XC11440C</b>	<b>137.975</b> 5.4321	<b>42.000</b> 1.6535	<b>1.0</b> .04	<b>XC11440D</b>	<b>204.975</b> 8.0699	<b>38.000</b> 1.4961	<b>3.5</b> .14	XC11440C: GROOVE IN ID BACKFACE SHOULDER ON ID BACKFACE
<b>*XC12087C</b>	<b>147.975</b> 5.8258	<b>48.003</b> 1.8899	<b>2.0</b> .08	<b>XC12087D</b>	<b>229.974</b> 9.0541	<b>40.000</b> 1.5748	<b>3.0</b> .12	XC12087C: SHOULDER ON ID BACKFACE GROOVE IN ID BACKFACE
<b>*XC12088C</b>	<b>307.950</b> 12.1240	<b>39.000</b> 1.5354	<b>1.0</b> .04	<b>XC12088D</b>	<b>377.949</b> 14.8799	<b>32.822</b> 1.2922	<b>2.5</b> .10	XC12088C: GROOVE IN ID BACKFACE SHOULDER ON ID BACKFACE
<b>*XC12089C</b>	<b>303.974</b> 11.9675	<b>38.000</b> 1.4961	<b>1.0</b> .04	<b>XC12089D</b>	<b>357.950</b> 14.0925	<b>26.000</b> 1.0236	<b>2.5</b> .10	XC12089C: GROOVE IN ID BACKFACE
<b>JXC12237CB</b>	<b>90.000</b> 3.5433	<b>34.000</b> 1.3386	<b>3.0</b> .12					
<b>*XC12237CA</b>	<b>86.000</b> 3.3858	<b>34.000</b> 1.3386	<b>3.0</b> .12	<b>*XC12237D</b>	<b>140.000</b> 5.7087	<b>27.000</b> 1.0630	<b>2.5</b> .10	XC12237CA: MADE FROM VACUUM MELT STEEL XC12237D: MADE FROM VACUUM MELT STEEL
<b>XC12890C</b>	<b>177.800</b> 7.0000	<b>19.583</b> .7710	<b>1.5</b> .06					
<b>*XC14387CC</b>	<b>317.500</b> 12.5000	<b>85.725</b> 3.3750	<b>3.5</b> .14					XC14387CC: NO SMALL RIB SHOULDER ON OD FRONTFACE
<b>XC14389C</b>	<b>284.975</b> 11.2195	<b>30.162</b> 1.1875	<b>3.5</b> .14	<b>XC14389D</b>	<b>349.949</b> 13.7775	<b>22.225</b> .8750	<b>3.3</b> .13	
<b>XC14390C</b>	<b>289.974</b> 11.4163	<b>46.038</b> 1.8125	<b>3.5</b> .14	<b>XC14390D</b>	<b>374.950</b> 14.7618	<b>34.925</b> 1.3750	<b>3.3</b> .13	
<b>*XC14637C</b>	<b>146.050</b> 5.7500	<b>28.575</b> 1.1250	<b>1.5</b> .06	<b>XC14637D</b>	<b>193.675</b> 7.6250	<b>23.020</b> .9063	<b>1.5</b> .06	XC14637C: MADE FROM VACUUM MELT STEEL
<b>XC14638C</b>	<b>75.000</b> 2.9528	<b>25.000</b> .9843	<b>3.0</b> .12					

<sup>1</sup>These Maximum Fillet Radii will be cleared by the Cone or Cup Radii.  
\* See Remarks Column.

NP Parts are made for specific applications.  
XC Parts are in limited production.

NP and XC PARTS

CONE			Max Shaft Fillet Radii R'	CUP			Max Hs'ng Fillet Radii r'	Remarks
Number	BORE d	WIDTH B		Number	OUTSIDE DIA D	WIDTH C		
*XC14886C	184.150	33.000	2.0	XC14638D	115.000	19.000	2.5	XC14886C: MADE FROM VACUUM MELT STEEL
	7.2500	1.2992	.08	XC14638DA	115.000	19.000	1.0	
*XC15886C	355.600	128.587	1.5	*XC14886D	235.229	28.000	2.0	XC14886D: MADE FROM VACUUM MELT STEEL
	14.0000	5.0625	.06	*XC15886D	482.600	52.388	3.3	XC15886D: MADE FROM SPECIAL STEEL
*JXC15888CD	190.000	109.000	3.0	JXC15888DA	260.000	36.500	2.5	JXC15888CD: INVERTED BEARING
XC15888C	190.000	44.000	3.0					
XC15888CA	185.000	44.000	3.0					
XC15889C	95.250	73.025	3.3	XC15888D	260.000	36.500	2.5	
XC15890C	100.000	40.000	3.0					
XC16686CB	80.000	49.212	2.0					
XC17338C	50.000	28.575	3.5	XC16690DB	62.000	11.300	2.0	
	1.9685	1.1250	.14					
*JXC17935CM	38.000	17.000	spcl.	XC17338D	115.000	20.638	3.5	JXC17935CM: SPECIAL BACKFACE RADIUS
*JXC17935CNA	38.000	19.000	spcl.					JXC17935CNA: EXTENDED SMALL RIB
*JXC17935CT	38.000	19.000	2.0					JXC17935CT: EXTENDED SMALL RIB SPECIAL SMALL RIB
	1.4961	.6693	.08	JXC17935DJ	63.000	13.500	1.3	
	1.4961	.7480	.08	JXC17935DK	63.000	13.500	1.3	
	1.4961	.7480	.08	*JXC17935DM	63.000	13.500	1.3	JXC17935DM: FLANGE ON OD FRONTFACE, BEARING WIDTH IS T1 DIMENSION
*XC17940C	304.800	50.800	6.4					
	12.0000	2.0000	.25					
*XC17940CB	304.800	50.800	6.4					XC17940C: SHOULDER ON OD FRONTFACE NO SMALL RIB
	12.0000	2.0000	.25					
*XC17940CC	304.800	50.800	6.4					XC17940CB: NO SMALL RIB SHOULDER ON OD FRONTFACE
	12.0000	2.0000	.25	*XC17940DD	393.700	82.550	1.5	
					15.5000	3.2500	.06	
				XC18136D	240.310	37.000	2.5	XC17940CC: MADE FROM SPECIAL STEEL
					9.4610	1.4567	.10	
				XC18140D	140.000	22.000	1.5	XC17940DD: HOLES IN OD CENTER GROOVE IN OD CENTER MADE FROM SPECIAL STEEL
					5.5118	.8661	.06	
*JXC18437CA	41.000	21.000	2.0					
	1.6142	.8268	.08					
XC18438C	170.000	38.000	3.0					JXC18437CA: FRONTFACE CHAMFER EXTENDED SMALL RIB
	6.6929	1.4961	.12					
XC18438CA	165.000	38.000	3.0					
	6.4961	1.4961	.12	XC18438D	230.000	31.000	2.5	
					9.0551	1.2205	.10	

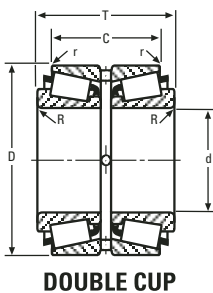
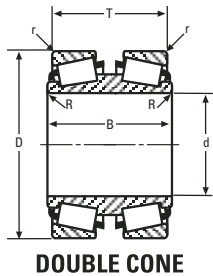
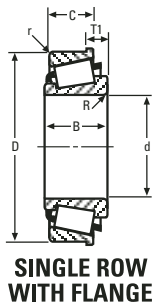
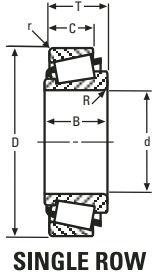

13

NP Parts are made for specific applications.  
XC Parts are in limited production.

\*\*These Maximum Fillet Radii will be cleared by the Cone or Cup Radii.  
\* See Remarks Column.



NP and XC PARTS

CONE			Max Shaft Fillet Radii R'	CUP			Max Hs'ng Fillet Radii r'	Remarks
Number	BORE d	WIDTH B		Number	OUTSIDE DIA D	WIDTH C		
*JXC18439CA	45.000 1.7717	32.000 1.2598	6.0 .24					JXC18439CA: FRONTFACE CHAMFER
				JXC18439DA	85.000 3.3465	25.000 .9843	1.5 .06	
*XC18440C	28.000 1.1024	19.205 .7561	1.0 .04					XC18440C: FRONTFACE CHAMFER EXTENDED SMALL RIB
*JXC19087CD	55.000 2.1654	38.000 1.4961	.8 .03					JXC19087CD: FRONTFACE CHAMFER
*JXC19087CG	50.000 1.9685	36.000 1.4173	.8 .03					JXC19087CG: FRONTFACE CHAMFER
*JXC19087CM	57.000 2.2441	48.210 1.8980	2.0 .08					JXC19087CM: EXTENDED SMALL RIB
*JXC19087CN	57.000 2.2441	52.275 2.0580	7.0 .28					GROOVE IN ID FRONTFACE
				*JXC19087D	110.000 4.3307	29.000 1.1417	1.5 .06	JXC19087CN: EXTENDED SMALL RIB GROOVE IN ID FRONTFACE
*JXC19089CB	65.000 2.5591	31.000 1.2205	.5 .02					JXC19087D: FLANGE ON OD FRONTFACE, BEARING WIDTH IS T1 DIMENSION
				*JXC19089DA	135.000 5.3150	34.000 1.3386	.5 .02	
JXC19090CB	30.000 1.1811	18.755 .7384	2.5 .10					JXC19089CB: FRONTFACE CHAMFER
JXC19090CC	30.000 1.1811	19.755 .7777	2.5 .10					JXC19089DA: FLANGE ON OD FRONTFACE, BEARING WIDTH IS T1 DIMENSION
				JXC19090DA	60.000 2.3622	37.000 1.4567	.5 .02	
				*JXC19090DB	58.000 2.2835	39.000 1.5354	N/A N/A	JXC19090DB: CHAMFER ON RIGHTFACE OD CHAMFER ON LEFTFACE OD
XC19090CA	25.000 .9843	17.793 .7005	3.5 .14					
*XC19936C	80.000 3.1496	44.900 1.7677	1.0 .04					XC19936C: SHOULDER ON ID BACKFACE FRONTFACE CHAMFER EXTENDED LARGE RIB
*XC19937C	90.000 3.5433	50.600 1.9921	1.0 .04					
*JXC19939C	100.000 3.9370	35.000 1.3780	spcl. spcl.					XC19937C: FRONTFACE CHAMFER SHOULDER ON ID BACKFACE
*JXC20436CA	130.000 5.1181	27.000 1.0630	3.0 .12					JXC19939C: SPECIAL BACKFACE RADIUS
				*JXC20436DC	188.050 7.4035	21.765 .8568	3.0 .12	JXC20436CA: HOLES IN BACKFACE TO UNDERCUT JXC20436DC: FLANGE ON OD FRONTFACE, BEARING WIDTH IS T1 DIMENSION
JXC20440C	57.000 2.2441	19.000 .7480	1.5 .06					
				XC23930D	90.000 3.5433	24.500 .9646	1.5 .06	
*JXC25368C	30.000 1.1811	28.000 1.1024	1.5 .06					JXC25368C: FRONTFACE CHAMFER
JXC25369C	63.000 2.4803	28.000 1.1024	3.0 .12					
*JXC25370CA	45.000 1.7717	20.000 .7874	3.5 .14					JXC25370CA: FRONTFACE CHAMFER
				JXC25370DA	75.000 2.9528	15.500 .6102	1.0 .04	
*JXC25373C	85.000 3.3465	32.000 1.2598	3.0 .12					JXC25373C: GROOVE IN OD BACKFACE EXTENDED LARGE RIB
*JXC25375C	42.000 1.6535	19.790 .7792	spcl. spcl.					JXC25375C: SPECIAL BACKFACE RADIUS
JXC25375CC	42.000 1.6535	18.790 .7398	3.5 .14					
JXC25375CD	39.000 1.5354	18.790 .7398	3.5 .14					
				*JXC25375D	72.000 2.8346	39.000 1.5354	spcl. spcl.	JXC25375D: SPECIAL CHAMFER ON RIGHTFACE OD SPECIAL CHAMFER ON LEFTFACE OD
				*JXC25375DB	72.000 2.8346	37.000 1.4567	spcl. spcl.	JXC25375DB: SPECIAL CHAMFER ON RIGHTFACE OD SPECIAL CHAMFER ON LEFTFACE OD
				*JXC25378DA	140.000 5.5118	27.000 1.0630	3.0 .12	

\*\*These Maximum Fillet Radii will be cleared by the Cone or Cup Radii.  
\* See Remarks Column.

NP Parts are made for specific applications.  
XC Parts are in limited production.

13

NP and XC PARTS

CONE			Max Shaft Fillet Radii R'	CUP			Max Hs'ng Fillet Radii r'	Remarks
Number	BORE d	WIDTH B		Number	OUTSIDE DIA D	WIDTH C		
				<b>JXC25378DB</b>	<b>140.000</b> 5.5118	<b>27.000</b> 1.0630	<b>3.0</b> .12	JXC25378DA: MADE FROM VACUUM MELT STEEL
				<b>XC25378D</b>	<b>150.000</b> 5.9055	<b>27.000</b> 1.0630	<b>3.0</b> .12	
<b>JXC25381CC</b>	<b>70.000</b> 2.7559	<b>42.000</b> 1.6535	<b>7.0</b> .28					
<b>*JXC25381CD</b>	<b>70.010</b> 2.7563	<b>53.730</b> 2.1153	<b>3.0</b> .12					JXC25381CD: GROOVE IN ID FRONTFACE EXTENDED SMALL RIB
<b>*JXC25381CE</b>	<b>70.010</b> 2.7563	<b>61.525</b> 2.4223	<b>8.0</b> .31					JXC25381CE: GROOVE IN ID FRONTFACE EXTENDED SMALL RIB
<b>*XC25384C</b>	<b>105.000</b> 4.1339	<b>35.000</b> 1.3780	<b>6.0</b> .24	<b>JXC25381DA</b>	<b>130.000</b> 5.1181	<b>35.000</b> 1.3780	<b>2.5</b> .10	XC25384C: FRONTFACE CHAMFER
<b>*JXC25389CE</b>	<b>55.000</b> 2.1654	<b>35.000</b> 1.3780	<b>2.0</b> .08	<b>XC25388D</b>	<b>140.000</b> 5.7087	<b>24.000</b> .9449	<b>2.5</b> .10	JXC25389CE: FRONTFACE CHAMFER
				<b>JXC25389D</b>	<b>100.000</b> 3.9370	<b>27.000</b> 1.0630	<b>1.5</b> .06	
<b>JXC25390C</b>	<b>32.000</b> 1.2598	<b>34.000</b> 1.3386	<b>.8</b> .03	<b>JXC25389DA</b>	<b>100.000</b> 3.9370	<b>27.000</b> 1.0630	<b>1.5</b> .06	
<b>JXC25396C</b>	<b>45.000</b> 1.7717	<b>24.000</b> .9449	<b>3.5</b> .14	<b>JXC25396D</b>	<b>75.000</b> 2.9528	<b>15.000</b> .5906	<b>2.3</b> .09	
<b>*JXC25414C</b>	<b>73.000</b> 2.8740	<b>34.000</b> 1.3386	spcl. spcl.	<b>*JXC25403DA</b>	<b>64.000</b> 2.5197	<b>16.500</b> .6496	<b>1.3</b> .05	JXC25403DA: SHOULDER ON ID FRONTFACE
<b>JXC25423C</b>	<b>32.000</b> 1.2598	<b>15.000</b> .5906	<b>3.5</b> .14	<b>*JXC25414D</b>	<b>130.000</b> 5.1181	<b>28.500</b> 1.1220	<b>2.5</b> .10	JXC25414C: BACKFACE CHAMFER SHOULDER ON ID BACKFACE JXC25414D: FLANGE ON OD FRONTFACE, BEARING WIDTH IS T1 DIMENSION
<b>*JXC25424C</b>	<b>49.000</b> 1.9291	<b>21.680</b> .8535	spcl. spcl.	<b>JXC25423D</b>	<b>53.000</b> 2.0866	<b>11.500</b> .4528	<b>1.3</b> .05	JXC25424C: SPECIAL BACKFACE RADIUS
<b>JXC25426C</b>	<b>94.000</b> 3.7008	<b>24.000</b> .9449	<b>.8</b> .03	<b>JXC25424D</b>	<b>84.000</b> 3.3071	<b>43.000</b> 1.6929	<b>.5</b> .02	
<b>JXC25427C</b>	<b>93.980</b> 3.7000	<b>49.000</b> 1.9291	<b>1.5</b> .06	<b>JXC25426D</b>	<b>130.175</b> 5.1250	<b>15.000</b> .5906	<b>.8</b> .03	
<b>*JXC25428C</b>	<b>99.000</b> 3.8976	<b>35.000</b> 1.3780	spcl. spcl.	<b>JXC25427D</b>	<b>152.400</b> 6.0000	<b>30.000</b> 1.1811	<b>1.5</b> .06	JXC25428C: FRONTFACE CHAMFER SPECIAL BACKFACE RADIUS
<b>*XC25433C</b>	<b>142.875</b> 5.6250	<b>35.300</b> 1.3898	<b>3.5</b> .14	<b>*XC25433DA</b>	<b>194.975</b> 7.6762	<b>27.500</b> 1.0827	<b>3.5</b> .14	XC25433C: MADE FROM VACUUM MELT STEEL XC25433DA: MADE FROM VACUUM MELT STEEL
<b>JXC25437CG</b>	<b>100.000</b> 3.9370	<b>28.255</b> 1.1124	<b>3.0</b> .12	<b>*JXC25437D</b>	<b>140.000</b> 5.7087	<b>34.000</b> 1.3386	<b>.8</b> .03	JXC25437D: SHOULDER ON ID FRONTFACE FLANGE ON OD FRONTFACE, BEARING WIDTH IS T1 DIMENSION GROOVE IN OD BACKFACE
<b>JXC25437DD</b>	<b>140.000</b> 5.7087	<b>17.500</b> .6890	<b>3.0</b> .12					
<b>JXC25439CA</b>	<b>38.000</b> 1.4961	<b>25.000</b> .9843	<b>2.0</b> .08					
<b>*JXC25440C</b>	<b>85.000</b> 3.3465	<b>36.000</b> 1.4173	<b>7.5</b> .30					JXC25440C: FRONTFACE CHAMFER
<b>*JXC25441C</b>	<b>95.000</b> 3.7402	<b>43.000</b> 1.6929	<b>6.0</b> .24					JXC25441C: FRONTFACE CHAMFER

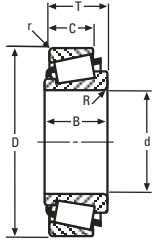

SINGLE ROW



SINGLE ROW WITH FLANGE

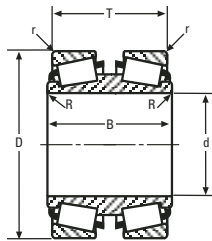

DOUBLE CONE

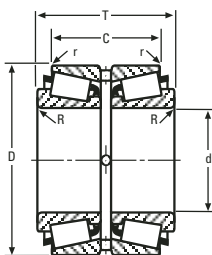

DOUBLE CUP

13

NP Parts are made for specific applications.  
XC Parts are in limited production.

\*\*These Maximum Fillet Radii will be cleared by the Cone or Cup Radii.  
\* See Remarks Column.

NP and XC PARTS

CONE			Max Shaft Fillet Radii R'	CUP			Max Hs'ng Fillet Radii r'	Remarks
Number	BORE d	WIDTH B		Number	OUTSIDE DIA D	WIDTH C		
*JXC25442CA	235.000 9.2520	45.000 1.7717	spcl. spcl.	JXC25442DA	295.000 11.6142	36.000 1.4173	3.0 .12	JXC25442CA: BACKFACE CHAMFER
XC25445C	350.520 13.8000	26.988 1.0625	.8 .03	*XC25445D	431.800 17.0000	24.765 .9750	1.0 .04	XC25445D: FLANGE ON OD FRONTFACE, BEARING WIDTH IS T1 DIMENSION
XC25446C	361.950 14.2500	30.162 1.1875	6.4 .25	*XC25446D	444.500 17.5000	26.911 1.0595	1.0 .04	XC25446D: FLANGE ON OD FRONTFACE, BEARING WIDTH IS T1 DIMENSION
*JXC25448C	180.000 7.0866	43.000 1.6929	3.0 .12					JXC25448C: GROOVE IN OD BACKFACE EXTENDED LARGE RIB
*XC25454C	259.931 10.2335	33.470 1.3177	1.5 .06					XC25454C: EXTENDED SMALL RIB
JXC25455C	38.000 1.4961	15.000 .5906	.8 .03	JXC25455D	58.000 2.2835	12.000 .4724	.8 .03	XC25457C: SHOULDER ON OD BACKFACE HOLES IN BACKFACE TO UNDERCUT
*XC25457C	447.675 17.6250	44.450 1.7500	3.3 .13					JXC25458C: GROOVE IN OD BACKFACE NO LARGE RIB STRAIGHT OD
*JXC25458C	490.000 19.2913	76.000 2.9921	3.0 .12	*JXC25458D	610.000 24.0157	110.000 4.3307	3.0 .12	JXC25458D: SHOULDER ON ID FRONTFACE STEPPED OD FRONTFACE
				JXC25459DB	130.000 5.1181	65.000 2.5591	2.0 .08	XC25468C: HOLES IN BACKFACE TO UNDERCUT
*XC25468C	215.900 8.5000	46.038 1.8125	3.5 .14					JXC25469C: SPECIAL BACKFACE RADIUS
*JXC25469C	49.000 1.9291	21.500 .8465	spcl. spcl.					
JXC25469CC	49.000 1.9291	24.000 .9449	2.8 .11					
JXC25479C	42.000 1.6535	19.500 .7677	3.5 .14					
JXC25479CC	42.000 1.6535	19.500 .7677	4.0 .16					
JXC25479CD	42.000 1.6535	19.500 .7677	1.0 .04					
JXC25479CE	42.000 1.6535	19.500 .7677	4.0 .16					
JXC25479CF	42.000 1.6535	19.500 .7677	1.0 .04					
JXC25479CG	42.000 1.6535	19.500 .7677	4.0 .16					
JXC25479CH	42.000 1.6535	19.500 .7677	1.0 .04					
JXC25479CJ	39.980 1.5740	20.000 .7874	3.3 .13					
XC25483C	1397.000 55.0000	117.475 4.6250	12.2 .48	*XC25483D	1735.000 68.3071	190.500 7.5000	3.3 .13	XC25483D: FLANGE ON OD LEFTFACE GROOVE IN OD CENTER
XC25484C	254.000 10.0000	114.300 4.5000	3.5 .14	*XC25484D	498.000 19.6063	260.000 10.2362	1.5 .06	XC25484D: SHOULDER ON OD RIGHTFACE
				XC25484DA	521.300 20.5236	260.000 10.2362	1.5 .06	
XC25486C	250.825 9.8750	20.638 .8125	2.0 .08	XC25486D	292.100 11.5000	15.875 .6250	2.0 .08	
XC25489C	1397.000 55.0000	117.475 4.6250	3.0 .12					

\*\*These Maximum Fillet Radii will be cleared by the Cone or Cup Radii.  
\* See Remarks Column.

NP Parts are made for specific applications.  
XC Parts are in limited production.

NP and XC PARTS

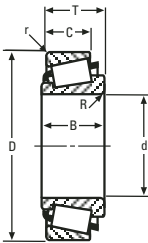
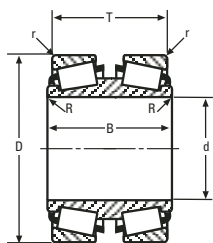
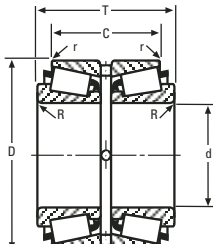
CONE			Max Shaft Fillet Radii R'	CUP			Max Hs'ng Fillet Radii r'	Remarks	
Number	BORE d	WIDTH B		Number	OUTSIDE DIA D	WIDTH C			
 <p><b>SINGLE ROW</b></p>	*XC25607C	209.550 8.2500	74.612 2.9375	1.5 .06	XC25489D *XC25493D XC25601D *XC25601DA XC25607D	1600.000 62.9921 323.825 12.7490 615.950 24.2500 59.246 2.3325 615.950 24.2500 307.975 12.1250	46.038 1.8125 50.800 .03 59.246 2.3325 62.420 2.4575 167.483 6.5938	6.0 .24 .8 .03 6.4 .25 4.6 .18 1.6 .06	XC25493D: HOLES IN RIGHTFACE ASYMMETRICAL BEARING  XC25601DA: SLOTS IN BACKFACE  XC25607C: EXTENDED SMALL RIB
	*XC25611C	103.124 4.0600	16.510 .6500	3.5 .14	XC25611D	131.318 5.1700	12.174 .4793	4.0 .16	XC25611C: MADE FROM SPECIAL STEEL
	*XC25611CA	103.124 4.0600	16.510 .6500	3.5 .14	*XC25611DA	131.318 5.1700	12.174 .4793	4.0 .16	XC25611CA: MADE FROM SPECIAL STEEL
	*XC25611CB	103.124 4.0600	16.510 .6500	3.5 .14	*XC25611DB	131.318 5.1700	12.174 .4793	4.0 .16	XC25611CB: MADE FROM SPECIAL STEEL
	*XC25614C	28.575 1.1250	15.276 .6014	3.5 .14	XC25614D	50.292 1.9800	10.749 .4232	1.3 .05	XC25614C: MADE FROM SPECIAL STEEL
	*JXC25618C	35.000 1.3780	18.000 .7087	1.0 .04	JXC25618D	72.000 2.8346	44.000 1.7323	1.0 .04	JXC25618C: NO SMALL RIB BROKEN FRONTFACE ID NO LARGE RIB STRAIGHT OD
	*XC25619C	101.600 4.0000	158.750 6.2500	.8 .03	JXC25619D	165.000 6.4961	28.000 1.1024	1.0 .04	JXC25618D: GROOVE IN ID FRONTFACE BROKEN CORNER ON FRONTFACE OD HOLES IN OD CENTER
	*XC25619CA	101.600 4.0000	158.750 6.2500	.8 .03	*JXC25620D	52.000 2.0472	37.000 1.4567	spcl. spcl.	XC25619C: HOLES IN OD RIGHTFACE EXTENDED SMALL RIB
	JXC25620C	25.000 .9843	18.755 .7384	1.0 .04	*JXC25620DA	52.000 2.0472	37.000 1.4567	spcl. spcl.	XC25619CA: EXTENDED SMALL RIB HOLES IN OD RIGHTFACE
	XC25626C	41.275 1.6250	28.481 1.1213	3.5 .14	XC25626D	79.375 3.1250	20.193 .7950	3.3 .13	JXC25620D: SPECIAL CHAMFER ON RIGHTFACE OD SPECIAL CHAMFER ON LEFTFACE OD
	*JXC25632C	80.000 3.1496	41.000 1.6142	3.0 .12	*JXC25629D	60.000 2.3622	13.000 .5118	1.5 .06	JXC25620DA: SPECIAL CHAMFER ON RIGHTFACE OD SPECIAL CHAMFER ON LEFTFACE OD
	 <p><b>DOUBLE CONE</b></p>	*JXC25640CB	30.000 1.1811	18.100 .7126	1.5 .06	*XC25639D	152.400 6.0000	31.242 1.2300	3.3 .13
*JXC25640CC		30.000 1.1811	18.100 .7126	1.5 .06	XC25639D	152.400 6.0000	31.242 1.2300	3.3 .13	JXC25632C: NO LARGE RIB SHOULDER ON OD BACKFACE
*XC25643C		50.800 2.0000	88.900 3.5000	.8 .03	*XC25640D	62.020 2.4417	15.535 .6117	1.5 .06	XC25639D: SHOULDER ON ID BACKFACE
XC25643D		50.800 2.0000	88.900 3.5000	.8 .03	*XC25640DA	62.020 2.4417	15.535 .6117	1.5 .06	JXC25640CB: FRONTFACE CHAMFER
 <p><b>DOUBLE CUP</b></p>								JXC25640CC: FRONTFACE CHAMFER	
									JXC25640D: FLANGE ON OD FRONTFACE, BEARING WIDTH IS T1 DIMENSION CHAMFER ON FRONTFACE OD
									JXC25640DA: FLANGE ON OD FRONTFACE, BEARING WIDTH IS T1 DIMENSION CHAMFER ON FRONTFACE OD

NP Parts are made for specific applications.  
XC Parts are in limited production.

\*\*These Maximum Fillet Radii will be cleared by the Cone or Cup Radii.  
\* See Remarks Column.

13

CONE			Max Shaft Fillet Radii R <sup>1</sup>	CUP			Max Hs'ng Fillet Radii r <sup>1</sup>	Remarks
Number	BORE d	WIDTH B		Number	OUTSIDE DIA D	WIDTH C		
JXC25647C	64.000 2.5197	28.355 1.1164	1.5 .06					XC25643C: EXTENDED SMALL RIB
JXC25647CB	64.025 2.5206	28.355 1.1164	1.5 .06					
				*JXC25647D	117.000 4.6063	54.145 2.1317	N/A N/A	JXC25647D: HOLES IN OD CENTER GROOVE IN OD CENTER
				*JXC25647DA	117.000 4.6063	58.640 2.3087	N/A N/A	ASYMMETRICAL - TWO SERIES BEARING
JXC25648C	64.000 2.5197	23.535 .9266	1.5 .06					JXC25647DA: ASYMMETRICAL - TWO SERIES BEARING HOLES IN OD CENTER GROOVE IN OD CENTER
JXC25648CA	70.000 2.7559	23.535 .9266	1.5 .06					
*JXC25662C	32.000 1.2598	29.500 1.1614	.8 .03					JXC25662C: FRONTFACE CHAMFER
*JXC25663CA	70.000 2.7559	40.000 1.5748	3.0 .12					JXC25663CA: FRONTFACE CHAMFER
				JXC25663DA	150.000 5.9055	31.750 1.2500	.5 .02	JXC25665CA: FRONTFACE CHAMFER
*JXC25665CA	28.000 1.1024	32.000 1.2598	2.5 .10					JXC25665CC: FRONTFACE CHAMFER
*JXC25665CC	28.000 1.1024	32.000 1.2598	2.5 .10					JXC25668CA: SPECIAL FRONTFACE RADIUS SPECIAL BACKFACE RADIUS
*JXC25668CA	38.000 1.4961	18.000 .7087	spcl. spcl.					
				JXC25668D	74.000 2.9134	16.500 .6496	2.0 .08	
XC25672CB	129.967 5.1168	74.500 2.9331	1.5 .06					
				*XC25672DA	239.873 9.4438	160.000 6.2992	spcl. spcl.	XC25672DA: SPECIAL RADIUS ON RIGHTFACE OD HOLES IN OD CENTER SPECIAL RADIUS ON LEFTFACE OD
*JXC25678CA	55.000 2.1654	23.000 .9055	3.0 .12					
				*JXC25678D	90.000 3.5433	17.500 .6890	1.5 .06	JXC25678CA: FRONTFACE CHAMFER
*JXC25679CB	110.000 4.3307	38.000 1.4961	6.5 .26					JXC25678D: FLANGE ON OD FRONTFACE, BEARING WIDTH IS T1 DIMENSION SPECIAL RADIUS ON FRONTFACE OD
				*XC25685DB	457.098 17.9960	36.551 1.4390	.5 .02	
				XC25685DD	457.098 17.9960	41.051 1.6162	3.3 .13	JXC25679CB: FRONTFACE CHAMFER
				*XC25685DE	457.098 17.9960	61.397 2.4172	3.3 .13	XC25685DB: SHOULDER ON OD BACKFACE
*JXC25690C	45.000 1.7717	27.000 1.0630	2.5 .10					XC25685DE: GROOVE IN OD CENTER SHOULDER ON ID BACKFACE
				JXC25690DA	110.000 4.3307	22.000 .8661	2.0 .08	JXC25690C: FRONTFACE CHAMFER
				*JXC25690DC	110.000 4.3307	23.000 .9055	2.0 .08	
XC25697CA	142.875 5.6250	45.245 1.7813	2.5 .10					JXC25690DC: FLANGE ON OD FRONTFACE, BEARING WIDTH IS T1 DIMENSION
				XC25697D	206.375 8.1250	34.529 1.3594	3.3 .13	
				XC25700DA	152.400 6.0000	35.100 1.3819	3.3 .13	
				JXC25702D	140.000 5.5118	28.000 1.1024	.4 .01	
*JXC25712C	80.000 3.1496	29.000 1.1417	1.5 .06					JXC25712C: FRONTFACE CHAMFER
*JXC25712CB	80.000 3.1496	29.000 1.1417	5.3 .21					JXC25712CB: FRONTFACE CHAMFER
				JXC25712D	125.000 4.9213	22.000 .8661	1.5 .06	JXC25715C: FRONTFACE CHAMFER
*JXC25715C	40.000 1.5748	38.000 1.4961	2.5 .10					

\*\*These Maximum Fillet Radii will be cleared by the Cone or Cup Radii.  
\* See Remarks Column.

NP Parts are made for specific applications.  
XC Parts are in limited production.

NP and XC PARTS

CONE			Max Shaft Fillet Radii R'	CUP			Max Hs'ng Fillet Radii r'	Remarks
Number	BORE d	WIDTH B		Number	OUTSIDE DIA D	WIDTH C		
*JXC25716C	75.000 2.9528	25.000 .9843	1.5 .06	*JXC25716CA	75.000 2.9528	25.000 .9843	4.0 .16	JXC25716C: FRONTFACE CHAMFER JXC25716CA: FRONTFACE CHAMFER
				JXC25716D	115.000 4.5276	19.000 .7480	1.5 .06	
				*XC25717D	69.474 2.7352	22.225 .8750	1.5 .06	XC25717D: FLANGE ON OD FRONTFACE, BEARING WIDTH IS T1 DIMENSION SPECIAL RADIUS ON FRONTFACE OD
*JXC25723C	70.000 2.7559	37.000 1.4567	2.0 .08					JXC25723C: FRONTFACE CHAMFER
*JXC25723CA	68.000 2.6772	55.305 2.1773	2.0 .08					JXC25723CA: GROOVE IN ID FRONTFACE
*JXC25723CB	68.000 2.6772	60.000 2.3622	spcl. spcl.					JXC25723CB: SPECIAL BACKFACE RADIUS FRONTFACE CHAMFER GROOVE IN ID FRONTFACE
*JXC25723CC	68.200 2.6850	60.000 2.3622	8.0 .32	JXC25723D	120.000 4.7244	29.000 1.1417	1.5 .06	JXC25723CC: GROOVE IN ID FRONTFACE
*XC25727C	146.050 5.7500	41.900 1.6496	3.5 .14	*XC25727D	203.200 8.0000	38.100 1.5000	3.5 .14	XC25727C: MADE FROM VACUUM MELT STEEL
				XC25736D	495.554 19.5100	88.900 3.5000	6.4 .25	XC25727D: MADE FROM VACUUM MELT STEEL
*JXC25739CA	55.000 2.1654	31.000 1.2205	3.0 .12	JXC25739D	115.000 4.5276	23.500 .9252	3.0 .12	JXC25739CA: FRONTFACE CHAMFER
*JXC25743C	45.975 1.8100	22.750 .8957	2.3 .09	JXC25743D	83.500 3.2874	17.500 .6890	1.5 .06	JXC25743C: FRONTFACE CHAMFER
*XC25745C	76.200 3.0000	7.620 .3000	1.3 .05	XC25745D	98.425 3.8750	7.145 .2813	1.3 .05	XC25745C: FRONTFACE CHAMFER NO SMALL RIB
XC25750C	90.000 3.5433	22.000 .8661	1.5 .06	*XC25750DA	135.000 5.3150	39.000 1.5354	.5 .02	XC25750DA: GROOVE IN OD CENTER HOLES IN OD CENTER
				*XC25756D	144.633 5.6942	44.846 1.7656	spcl. spcl.	XC25756D: SPECIAL RADIUS ON RIGHTFACE OD SPECIAL RADIUS ON LEFTFACE OD SPHERICAL OD HOLES IN OD CENTER
*JXC25763C	50.000 1.9685	23.000 .9055	3.0 .12	JXC25763D	95.000 3.7402	19.000 .7480	1.5 .06	JXC25763C: FRONTFACE CHAMFER
*XC25767CA	142.024 5.5915	15.969 .6287	spcl. spcl.	*XC25767DA	191.834 7.5525	35.116 1.3825	1.2 .04	XC25767CA: BACKFACE CHAMFER FRONTFACE CHAMFER NO SMALL RIB
*XC25768CA	151.973 5.9832	15.016 .5912	5.3 .21	*XC25768DA	197.957 7.7936	10.485 .4128	5.5 .22	XC25767DA: CHAMFER ON FRONTFACE OD CHAMFER ON BACKFACE OD THREADED OD FRONTFACE
*JXC25769C	50.000 1.9685	29.000 1.1417	6.0 .24	*XC25772D	237.249 9.3405	73.914 2.9100	spcl. spcl.	XC25768CA: NO SMALL RIB
*JXC25779C	55.000 2.1654	25.165 .9908	1.5 .06	XC25779D	96.838 3.8125	15.875 .6250	.8 .03	XC25768DA: BROKEN CORNER ON FRONTFACE OD
JXC25780C	40.000 1.5748	24.700 .9724	1.5 .06	*JXC25780D	95.000 3.7402	39.800 1.5669	1.5 .06	JXC25779C: FRONTFACE CHAMFER
								XC25772D: HOLES IN OD CENTER SPHERICAL OD SPECIAL RADIUS ON LEFTFACE OD SPECIAL RADIUS ON RIGHTFACE OD

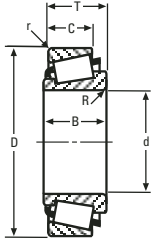

SINGLE ROW

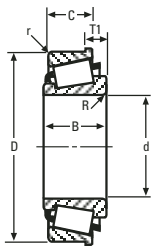

SINGLE ROW WITH FLANGE

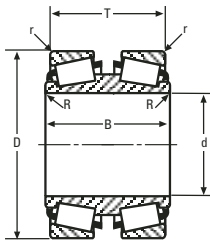

DOUBLE CONE

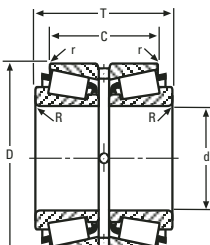

DOUBLE CUP

13

NP Parts are made for specific applications.  
XC Parts are in limited production.

\*\*These Maximum Fillet Radii will be cleared by the Cone or Cup Radii.  
\* See Remarks Column.

NP and XC PARTS

CONE			Max Shaft Fillet Radii R <sup>1</sup>	CUP			Max Hs'ng Fillet Radii r <sup>1</sup>	Remarks
Number	BORE d	WIDTH B		Number	OUTSIDE DIA D	WIDTH C		
*JXC25784C	28.000 1.1024	35.800 1.4094	2.5 .10	*XC25789D	177.800 7.0000	48.293 1.9013	spcl. spcl.	JXC25779C: EXTENDED SMALL RIB JXC25780D: FLANGE ON OD RIGHTFACE ASYMMETRICAL - TWO SERIES BEARING SHOULDER ON OD LEFTFACE
*JXC25799C	90.000 3.5433	16.000 .6299	1.0 .04	JXC25799D	115.020 4.5283	8.815 .3471	1.0 .04	JXC25784C: FRONTFACE CHAMFER
XC25820C	433.388 17.0625	27.783 1.0938	.8 .03	*JXC25806D	100.000 3.9370	21.000 .8268	1.5 .06	XC25789D: SPECIAL RADIUS ON RIGHTFACE OD SPHERICAL OD HOLES IN OD CENTER
XC25823C	234.848 9.2460	50.008 1.9688	3.5 .14	*XC25820D	485.775 19.1250	21.433 .8438	3.3 .13	SPECIAL RADIUS ON LEFTFACE OD JXC25799C: FRONTFACE CHAMFER EXTENDED LARGE RIB
XC25824C	76.200 3.0000	53.183 2.0938	3.5 .14	*XC25823D	311.150 12.2500	33.338 1.3125	3.3 .13	JXC25806D: FLANGE ON OD FRONTFACE, BEARING WIDTH IS T1 DIMENSION
*XC25831CB	149.967 5.9042	70.000 2.7559	3.0 .12	*XC25831DA	249.872 9.8375	160.000 6.2992	N/A N/A	XC25820D: GROOVE IN ID FRONTFACE SHOULDER ON ID FRONTFACE
*XC25868C	196.850 7.7500	44.450 1.7500	3.5 .14	*XC25862D	152.425 6.0010	53.183 2.0938	N/A N/A	XC25823D: FLANGE ON OD FRONTFACE, BEARING WIDTH IS T1 DIMENSION
NP005797	190.500 7.5000	46.833 1.8438	3.5 .14	*XC25876D	130.962 5.1560	42.860 1.6874	N/A N/A	XC25831CB: FRONTFACE CHAMFER
NP006115	71.438 2.8125	36.512 1.4375	3.5 .14	*XC25877D	185.763 7.3135	62.309 2.4531	N/A N/A	XC25831DA: GROOVE IN OD CENTER
NP006327	75.000 2.9528	51.000 2.0079	3.0 .12	*XC25880D	223.838 8.8125	84.930 3.3437	N/A N/A	XC25862D: SPHERICAL OD HOLES IN OD CENTER
NP008789	119.957 4.7227	57.500 2.2638	1.5 .06	*XC25888D	201.612 7.9375	75.408 2.9688	N/A N/A	XC25868C: EXTENDED SMALL RIB
NP008806	266.700 10.5000	109.538 4.3125	1.5 .06	*XC25889D	293.726 11.5640	113.508 4.4688	N/A N/A	XC25876D: HOLES IN OD CENTER SPHERICAL OD
*NP009805	38.100 1.5000	29.771 1.1721	.8 .03	*XC25890D	349.225 13.7490	120.650 4.7500	N/A N/A	XC25890D: SPHERICAL OD HOLES IN OD CENTER
NP027538	25.000 .9843	22.000 .8661	1.0 .04	NP002293	100.000 3.9370	26.990 1.0625	.8 .03	XC25877D: HOLES IN OD CENTER SPHERICAL OD
*NP030633	90.000 3.5433	62.755 2.4706	10.0 .39	NP016286	82.550 3.2500	23.020 .9063	3.3 .13	NP009805: FRONTFACE CHAMFER
*NP033571	127.000 5.0000	46.830 1.8437	3.5 .14	NP024261	140.000 5.5118	28.575 1.1250	3.5 .14	NP027538: FRONTFACE CHAMFER
				NP030857	90.000 3.5433	22.855 .8999	1.5 .06	NP030633: EXTENDED SMALL RIB GROOVE IN ID FRONTFACE SHOULDER ON OD BACKFACE
								NP033571: EXTENDED LARGE RIB

\*\*These Maximum Fillet Radii will be cleared by the Cone or Cup Radii.  
\* See Remarks Column.

NP Parts are made for specific applications.  
XC Parts are in limited production.

13

NP and XC PARTS

CONE			Max Shaft Fillet Radii R'	CUP			Max Hs'ng Fillet Radii r'	Remarks
Number	BORE d	WIDTH B		Number	OUTSIDE DIA D	WIDTH C		
				*NP035457	244.874 9.6407	170.000 6.6929	N/A N/A	NP035457: GROOVE IN OD CENTER
				*NP037463	90.000 3.5433	27.000 1.0630	1.5 .06	NP037463: KEYWAY IN OD BACKFACE
				NP052626	112.712 4.4375	19.050 .7500	3.3 .13	
								NP062901: FRONTFACE CHAMFER
				*NP063979	482.600 19.0000	107.950 4.2500	1.5 .06	NP063979: HOLES IN OD CENTER GROOVE IN OD CENTER
								NP064953
								NP069631
								NP076564
								NP079516
								NP083847
				*NP089873	355.600 14.0000	101.600 4.0000	1.5 .06	NP089873: HOLES IN OD CENTER GROOVE IN OD CENTER
								NP097363
				*NP100371	120.000 4.7244	42.000 1.6535	.8 .03	NP100371: CHAMFER ON LEFTFACE OD CHAMFER ON RIGHTFACE OD
								NP101379
								NP102036
				*NP106959	150.000 5.9055	24.000 .9449	2.0 .08	NP106959: CHAMFER ON FRONTFACE OD FLANGE ON OD FRONTFACE, BEARING WIDTH IS T1 DIMENSION
				NP106970	80.000 3.1496	15.500 .6102	1.0 .04	
								NP108340
								NP108543
								*NP109544
								*NP110611
								NP111385
								*NP113315
								*NP113645
								*NP113979
				NP116172	168.275 6.6250	41.275 1.6250	3.3 .13	
				NP120899	260.350 10.2500	41.275 1.6250	3.3 .13	
				NP122729	90.000 3.5433	23.000 .9055	2.5 .10	
				NP122954	212.725 8.3750	53.975 2.1250	3.3 .13	
				NP125626	50.000 1.9685	21.500 .8465	3.0 .12	
				NP129939	180.975 7.1250	25.400 1.0000	3.3 .13	

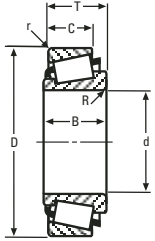

SINGLE ROW

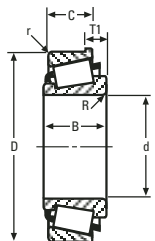

SINGLE ROW WITH FLANGE

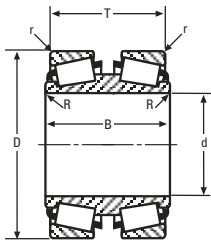

DOUBLE CONE

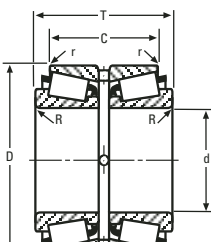

DOUBLE CUP

13

NP Parts are made for specific applications.  
XC Parts are in limited production.

\*\*These Maximum Fillet Radii will be cleared by the Cone or Cup Radii.  
\* See Remarks Column.



NP and XC PARTS

CONE			Max Shaft Fillet Radii R <sup>1</sup>	CUP			Max Hs'ng Fillet Radii r <sup>1</sup>	Remarks
Number	BORE d	WIDTH B		Number	OUTSIDE DIA D	WIDTH C		
NP130281	88.900 3.5000	56.363 2.2190	3.5 .14					
NP130380	101.600 4.0000	57.531 2.2650	8.0 .31					
NP134527	114.300 4.5000	66.675 2.6250	7.0 .28					
				*NP137905	84.000 3.3071	53.000 2.0866	spcl. spcl.	NP137905: SPECIAL CHAMFER ON RIGHTFACE OD SPECIAL CHAMFER ON LEFTFACE OD
NP138515	27.000 1.0630	22.500 .8858	1.5 .06					
NP138708	63.500 2.5000	30.048 1.1830	2.0 .08					
				*NP142179	675.000 26.5748	63.500 2.5000	3.5 .14	NP142179: SLOTS IN BACKFACE
				NP147197	125.000 4.9213	22.000 .8661	1.5 .06	
				NP153717	42.862 1.6875	9.525 .3750	1.5 .06	
				NP156827	152.400 6.0000	30.162 1.1875	3.3 .13	
NP159006	23.812 .9375	21.463 .8450	1.5 .06					
				NP159648	127.000 5.0000	26.988 1.0625	3.3 .13	
*NP168674	479.425 18.8750	128.587 5.0625	6.4 .25					NP168674: SLOTS IN BACKFACE
NP174018	96.838 3.8125	28.971 1.1406	3.5 .14					
				NP177400	68.000 2.6772	14.500 .5709	1.5 .06	
NP177778	66.675 2.6250	38.354 1.5100	3.5 .14					
NP179928	76.200 3.0000	46.038 1.8125	3.5 .14					
				NP183151	140.000 5.7087	27.000 1.0630	2.5 .10	
NP183776	28.500 1.1220	14.730 .5800	1.0 .04					
				NP188393	127.000 5.0000	26.988 1.0625	3.3 .13	
*NP189575	68.262 2.6875	39.688 1.5625	3.5 .14					NP189575: FRONTFACE CHAMFER
				NP194962	50.292 1.9800	10.668 .4200	1.3 .05	
				NP199047	104.775 4.1250	28.575 1.1250	3.3 .13	
NP201810	63.500 2.5000	56.007 2.2050	4.3 .17					NP202138: FRONTFACE CHAMFER
*NP202138	152.400 6.0000	66.675 2.6250	7.0 .28					
NP202653	33.338 1.3125	28.575 1.1250	.8 .03					
*NP203305	65.000 2.5591	31.000 1.2205	2.0 .08					NP203305: FRONTFACE CHAMFER
NP208481	152.400 6.0000	46.830 1.8437	3.5 .14					
				*NP212181	80.000 3.1496	12.500 .4921	1.0 .04	NP212181: FLANGE ON OD FRONTFACE, BEARING WIDTH IS T1 DIMENSION
NP212764	85.000 3.3465	29.000 1.1417	3.0 .12					
				NP218183	149.225 5.8750	44.450 1.7500	3.3 .13	
*NP223588	34.925 1.3750	18.288 .7200	spcl. spcl.					NP223588: SPECIAL BACKFACE RADIUS
				NP224557	75.500 2.9724	14.732 .5800	.8 .03	

\*\*These Maximum Fillet Radii will be cleared by the Cone or Cup Radii.  
\* See Remarks Column.

NP Parts are made for specific applications.  
XC Parts are in limited production.

13

**NP and XC PARTS**

CONE			Max Shaft Fillet Radii R'	CUP			Max Hs'ng Fillet Radii r'	Remarks
Number	BORE d	WIDTH B		Number	OUTSIDE DIA D	WIDTH C		
				*NP224896	42.862 1.6875	9.525 .3750	1.5 .06	NP224896: BROKEN CORNER ON FRONTFACE OD
				NP227619	55.000 2.1654	13.000 .5118	1.0 .04	
								NP228079: FRONTFACE CHAMFER
	*NP228079	50.000 1.9685	41.000 1.6142					
	NP230343	355.600 14.0000	128.587 5.0625					
				NP230788	346.075 13.6250	50.800 2.0000	6.4 .25	
	NP233968	133.350 5.2500	46.038 1.8125					
				*NP235483	114.300 4.5000	34.925 1.3750	3.3 .13	NP235483: FLANGE ON OD FRONTFACE, BEARING WIDTH IS T1 DIMENSION
				NP235899	72.000 2.8346	19.485 .7672	1.5 .06	
	*NP238787	333.375 13.1250	90.488 3.5625					NP238787: KEYWAY IN ID FRONTFACE
	*NP239427	165.087 6.4995	88.392 3.4800					NP239427: EXTENDED LARGE RIB EXTENDED SMALL RIB
				NP241715	200.000 7.8740	34.925 1.3750	3.3 .13	
	NP242161	100.000 3.9370	46.000 1.8110					
				*NP243097	655.000 25.7874	65.000 2.5591	3.3 .13	NP243097: HOLES IN BACKFACE
	NP245592	90.488 3.5625	48.260 1.9000					
	NP251532	80.000 3.1496	28.000 1.1024					
	NP252845	41.275 1.6250	19.812 .7800					
	*NP253527	101.600 4.0000	68.000 2.6772					NP253527: FRONTFACE CHAMFER SLOTS IN FRONTFACE
				NP256087	140.000 5.7087	24.000 .9449	1.5 .06	
				*NP259680	65.088 2.5625	15.875 .6250	1.5 .06	NP259680: KEYWAY IN OD BACKFACE
				NP261254	358.775 14.1250	53.975 2.1250	3.3 .13	
				NP264596	190.500 7.5000	46.038 1.8125	1.5 .06	
	NP264845	101.600 4.0000	57.531 2.2650					
				*NP266168	655.000 25.7874	65.000 2.5591	3.3 .13	NP266168: HOLES IN BACKFACE
				NP266492	110.000 4.3307	18.824 .7411	1.3 .05	
	*NP268853	50.000 1.9685	41.000 1.6142					NP268853: FRONTFACE CHAMFER
	*NP273081	101.600 4.0000	63.500 2.5000					NP273081: FRONTFACE CHAMFER SHOULDER ON ID FRONTFACE
	*NP275832	45.000 1.7717	26.500 1.0433					NP275832: FRONTFACE CHAMFER
	NP282175	25.000 .9843	16.000 .6299					
				NP282407	80.000 3.1496	17.826 .7018	1.3 .05	
				*NP285161	69.474 2.7352	22.225 .8750	1.5 .06	NP285161: SPECIAL RADIUS ON FRONTFACE OD FLANGE ON OD FRONTFACE, BEARING WIDTH IS T1 DIMENSION
				NP290596	168.275 6.6250	41.275 1.6250	3.3 .13	
				NP292535	679.450 26.7500	101.600 4.0000	6.4 .25	
	NP294742	45.000 1.7717	20.000 .7874					

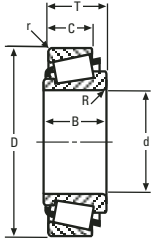

**SINGLE ROW**



**SINGLE ROW WITH FLANGE**

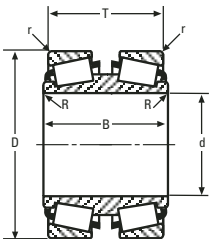

**DOUBLE CONE**

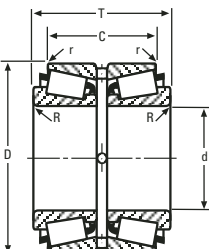

**DOUBLE CUP**

**13**

NP Parts are made for specific applications.  
XC Parts are in limited production.

\*\*These Maximum Fillet Radii will be cleared by the Cone or Cup Radii.  
\* See Remarks Column.

NP and XC PARTS

CONE			Max Shaft Fillet Radii R <sup>1</sup>	CUP			Max Hs'ng Fillet Radii r <sup>1</sup>	Remarks
Number	BORE d	WIDTH B		Number	OUTSIDE DIA D	WIDTH C		
				<b>NP294963</b>	<b>59.974</b> 2.3612	<b>11.938</b> .4700	<b>1.3</b> .05	
<b>NP296458</b>	<b>203.200</b> 8.0000	<b>57.945</b> 2.2813	<b>9.7</b> .38					
<b>NP297576</b>	<b>41.275</b> 1.6250	<b>19.812</b> .7800	<b>3.5</b> .14					
<b>*NP298271</b>	<b>55.000</b> 2.1654	<b>23.000</b> .9055	<b>1.5</b> .06					NP298271: FRONTFACE CHAMFER
				<b>*NP304907</b>	<b>140.000</b> 5.5118	<b>28.000</b> 1.1024	<b>.4</b> .01	
				<b>NP307444</b>	<b>180.000</b> 7.0866	<b>39.000</b> 1.5354	<b>2.5</b> .10	
<b>NP307693</b>	<b>90.000</b> 3.5433	<b>34.000</b> 1.3386	<b>3.0</b> .12					
<b>*NP307772</b>	<b>55.000</b> 2.1654	<b>23.000</b> .9055	<b>1.5</b> .06					NP307772: FRONTFACE CHAMFER
<b>*NP307784</b>	<b>35.000</b> 1.3780	<b>18.000</b> .7087	<b>1.0</b> .04					NP307784: FRONTFACE CHAMFER
<b>NP309336</b>	<b>80.000</b> 3.1496	<b>34.000</b> 1.3386	<b>3.0</b> .12					
				<b>NP312529</b>	<b>82.000</b> 3.2283	<b>17.000</b> .6693	<b>2.0</b> .08	
<b>NP313363</b>	<b>76.200</b> 3.0000	<b>56.363</b> 2.2190	<b>6.4</b> .25					
<b>NP313972</b>	<b>70.000</b> 2.7559	<b>42.000</b> 1.6535	<b>3.0</b> .12					
				<b>NP315658</b>	<b>190.500</b> 7.5000	<b>46.038</b> 1.8125	<b>3.3</b> .13	
<b>*NP315939</b>	<b>100.000</b> 3.9370	<b>39.000</b> 1.5354	<b>6.0</b> .24					NP315939: FRONTFACE CHAMFER
				<b>NP316098</b>	<b>82.000</b> 3.2283	<b>17.000</b> .6693	<b>2.0</b> .08	
<b>*NP316592</b>	<b>35.000</b> 1.3780	<b>18.000</b> .7087	<b>3.3</b> .13					NP316592: FRONTFACE CHAMFER
				<b>NP317251</b>	<b>148.430</b> 5.8437	<b>21.433</b> .8438	<b>3.0</b> .12	
				<b>NP317439</b>	<b>79.375</b> 3.1250	<b>23.812</b> .9375	<b>3.3</b> .13	
				<b>*NP319428</b>	<b>253.957</b> 9.9983	<b>144.018</b> 5.6700	<b>1.0</b> .04	
<b>*NP323058</b>	<b>105.000</b> 4.1339	<b>43.000</b> 1.6929	<b>6.0</b> .24					NP319428: CHAMFER ON LEFTFACE OD ASYMMETRICAL BEARING CHAMFER ON RIGHTFACE OD GROOVE IN OD CENTER
				<b>NP329140</b>	<b>122.238</b> 4.8125	<b>29.718</b> 1.1700	<b>3.3</b> .13	
<b>*NP331550</b>	<b>50.800</b> 2.0000	<b>44.450</b> 1.7500	<b>3.5</b> .14					NP323058: FRONTFACE CHAMFER NP331550: FRONTFACE CHAMFER
<b>NP333133</b>	<b>45.000</b> 1.7717	<b>21.625</b> .8514	<b>1.0</b> .04					
				<b>*NP335917</b>	<b>249.872</b> 9.8375	<b>160.000</b> 6.2992	<b>spcl.</b> spcl.	
<b>*NP342389</b>	<b>406.400</b> 16.0000	<b>190.500</b> 7.5000	<b>3.3</b> .13					NP335917: GROOVE IN OD CENTER SPECIAL CHAMFER ON RIGHTFACE OD SPECIAL CHAMFER ON LEFTFACE OD
<b>*NP345107</b>	<b>145.674</b> 5.7352	<b>89.220</b> 3.5126	<b>1.5</b> .06					NP342389: EXTENDED SMALL RIB GROOVE IN ID
<b>*NP351444</b>	<b>45.987</b> 1.8105	<b>18.000</b> .7087	<b>2.3</b> .09					NP35107: NO SMALL RIB GROOVE IN OD CENTER INVERTED BEARING
				<b>NP353162</b>	<b>280.000</b> 11.0236	<b>48.000</b> 1.8898	<b>3.5</b> .14	
<b>*NP353549</b>	<b>35.000</b> 1.3780	<b>23.500</b> .9252	<b>2.0</b> .08					TAPERED BORE
				<b>*NP353933</b>	<b>68.262</b> 2.6875	<b>11.908</b> .4688	<b>1.5</b> .06	
				<b>NP354665</b>	<b>158.750</b> 6.2500	<b>15.875</b> .6250	<b>3.3</b> .13	
				<b>NP354913</b>	<b>1509.715</b> 59.4375	<b>182.865</b> 7.1994	<b>12.7</b> .50	
								NP351444: FRONTFACE CHAMFER NP353549: FRONTFACE CHAMFER NP353933: SPECIAL RADIUS ON FRONTFACE OD FLANGE ON OD FRONTFACE, BEARING WIDTH IS T1 DIMENSION

\*\*These Maximum Fillet Radii will be cleared by the Cone or Cup Radii.  
\* See Remarks Column.

NP Parts are made for specific applications.  
XC Parts are in limited production.

**NP and XC PARTS**

CONE			Max Shaft Fillet Radii R'	CUP			Max Hs'ng Fillet Radii r'	Remarks
Number	BORE d	WIDTH B		Number	OUTSIDE DIA D	WIDTH C		
				<b>*NP355383</b>	<b>200.000</b> 7.8740	<b>34.925</b> 1.3750	<b>3.3</b> .13	NP355383: FLANGE ON OD FRONTFACE, BEARING WIDTH IS T1 DIMENSION
<b>NP358464</b>	<b>35.000</b> 1.3780	<b>18.000</b> .7087	<b>1.5</b> .06	<b>NP363867</b>	<b>122.238</b> 4.8125	<b>29.718</b> 1.1700	<b>3.3</b> .13	
<b>NP362252</b>	<b>49.212</b> 1.9375	<b>36.512</b> 1.4375	<b>3.5</b> .14	<b>*NP366621</b>	<b>220.000</b> 8.6614	<b>23.000</b> .9055	<b>3.0</b> .12	NP366621: KEYWAY IN OD BACKFACE
<b>*NP369824</b>	<b>28.000</b> 1.1024	<b>17.460</b> .6875	<b>3.5</b> .14	<b>NP366890</b>	<b>196.850</b> 7.7500	<b>38.100</b> 1.5000	<b>3.3</b> .13	NP369824: FRONTFACE CHAMFER
<b>NP379418</b>	<b>146.050</b> 5.7500	<b>82.550</b> 3.2500	<b>6.4</b> .25	<b>*NP380316</b>	<b>635.000</b> 25.0000	<b>112.649</b> 4.4350	<b>spcl.</b> spcl.	NP380316: SPECIAL CHAMFER ON BACKFACE OD SPECIAL CHAMFER ON FRONTFACE OD
<b>NP379811</b>	<b>65.000</b> 2.5591	<b>23.000</b> .9055	<b>3.0</b> .12	<b>NP385281</b>	<b>655.000</b> 25.7874	<b>76.000</b> 2.9921	<b>6.5</b> .26	SHOULDER ON OD FRONTFACE HOLES IN OD FRONTFACE
				<b>*NP387991</b>	<b>562.000</b> 22.1260	<b>70.000</b> 2.7559	<b>4.0</b> .16	NP387991: HOLES IN BACKFACE
				<b>NP390444</b>	<b>31.750</b> 1.2500	<b>19.050</b> .7500	<b>spcl.</b> spcl.	NP390444: SPECIAL BACKFACE RADIUS
				<b>NP390451</b>	<b>73.025</b> 2.8750	<b>54.229</b> 2.1350	<b>3.5</b> .14	
				<b>NP392358</b>	<b>317.500</b> 12.5000	<b>85.725</b> 3.3750	<b>3.5</b> .14	
				<b>NP393593</b>	<b>196.850</b> 7.7500	<b>38.100</b> 1.5000	<b>3.3</b> .13	
				<b>*NP394948</b>	<b>635.000</b> 25.0000	<b>112.039</b> 4.4110	<b>6.4</b> .25	NP394948: HOLES IN OD FRONTFACE SPECIAL CHAMFER ON FRONTFACE OD
<b>NP398617</b>	<b>68.262</b> 2.6875	<b>46.038</b> 1.8125	<b>3.5</b> .14	<b>NP400383</b>	<b>150.000</b> 5.9055	<b>24.000</b> .9449	<b>1.0</b> .04	CHAMFER ON BACKFACE OD SHOULDER ON OD FRONTFACE
<b>*NP401015</b>	<b>45.100</b> 1.7756	<b>16.100</b> .6339	<b>1.0</b> .04	<b>NP401046</b>	<b>136.525</b> 5.3750	<b>38.100</b> 1.5000	<b>1.5</b> .06	NP401015: FRONTFACE CHAMFER
				<b>NP402276</b>	<b>76.200</b> 3.0000	<b>23.020</b> .9063	<b>3.3</b> .13	
				<b>*NP402973</b>	<b>72.111</b> 2.8390	<b>14.732</b> .5800	<b>.8</b> .03	NP402973: BROKEN CORNER ON FRONTFACE OD
				<b>NP403673</b>	<b>320.000</b> 12.5984	<b>30.000</b> 1.1811	<b>3.0</b> .12	
<b>*NP407977</b>	<b>30.000</b> 1.1811	<b>16.700</b> .6575	<b>.4</b> .01	<b>*NP408197</b>	<b>219.873</b> 8.6564	<b>155.000</b> 6.1024	<b>N/A</b> N/A	NP407977: FRONTFACE CHAMFER
				<b>NP409741</b>	<b>140.000</b> 5.7087	<b>42.000</b> 1.6535	<b>2.5</b> .10	NP408197: GROOVE IN OD CENTER HOLES IN OD CENTER
<b>*NP412314</b>	<b>35.000</b> 1.3780	<b>28.000</b> 1.1024	<b>1.5</b> .06	<b>NP417842</b>	<b>73.431</b> 2.8910	<b>14.732</b> .5800	<b>.8</b> .03	NP412314: FRONTFACE CHAMFER
<b>*NP416359</b>	<b>80.000</b> 3.1496	<b>29.000</b> 1.1417	<b>1.5</b> .06	<b>NP419272</b>	<b>50.810</b> 2.0004	<b>11.808</b> .4649	<b>1.5</b> .06	NP416359: FRONTFACE CHAMFER
				<b>NP420110</b>	<b>150.000</b> 5.9055	<b>30.000</b> 1.1811	<b>2.5</b> .10	
				<b>NP420308</b>	<b>77.788</b> 3.0625	<b>15.080</b> .5937	<b>.8</b> .03	

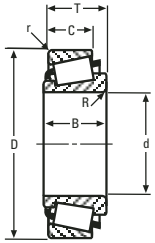

**SINGLE ROW**



**SINGLE ROW WITH FLANGE**

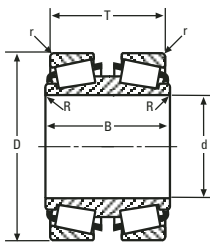

**DOUBLE CONE**

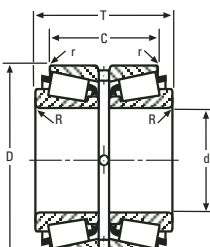

**DOUBLE CUP**

**13**

NP Parts are made for specific applications.  
XC Parts are in limited production.

\*\*These Maximum Fillet Radii will be cleared by the Cone or Cup Radii.  
\* See Remarks Column.

NP and XC PARTS

CONE			Max Shaft Fillet Radii R'	CUP			Max Hs'ng Fillet Radii r'	Remarks
Number	BORE d	WIDTH B		Number	OUTSIDE DIA D	WIDTH C		
NP427955	50.800 2.0000	44.475 1.7510	.8 .03	NP421556	469.900 18.5000	71.438 2.8125	3.3 .13	
				NP423026	234.950 9.2500	49.212 1.9375	3.3 .13	
				NP428883	72.000 2.8346	22.000 .8661	1.5 .06	
				NP430381	82.931 3.2650	17.462 .6875	.8 .03	
NP430408	140.000 5.5118	33.000 1.2992	3.5 .14	NP433706	190.500 7.5000	46.038 1.8125	1.5 .06	
NP435084	69.850 2.7500	56.363 2.2190	3.5 .14	NP436465	76.992 3.0312	11.908 .4688	1.5 .06	
NP439027	101.600 4.0000	73.025 2.8750	6.4 .25	NP437479	80.000 3.1496	15.500 .6102	1.0 .04	
*NP440642	90.000 3.5433	62.755 2.4706	10.0 .39	*NP442870	139.992 5.5115	28.575 1.1250	3.3 .13	NP440642: SPECIAL SMALL RIB EXTENDED SMALL RIB GROOVE IN ID FRONTFACE
NP444242	50.000 1.9685	28.000 1.1024	3.0 .12	NP443198	300.000 11.8110	51.000 2.0079	2.5 .10	NP442870: FLANGE ON OD FRONTFACE, BEARING WIDTH IS T1 DIMENSION
NP449291	45.242 1.7812	19.842 .7812	3.5 .14	NP453732	655.000 25.7874	76.000 2.9921	6.5 .26	
*NP455275	55.000 2.1654	30.000 1.1811	3.0 .12	*NP455898	514.350 20.2500	52.000 2.0472	4.0 .16	NP455275: GROOVE IN ID FRONTFACE SHOULDER ON ID FRONTFACE FRONTFACE CHAMFER EXTENDED SMALL RIB
*NP455350	34.988 1.3775	18.000 .7087	spcl. spcl.	NP460543	212.725 8.3750	53.975 2.1250	3.3 .13	NP455350: SPECIAL BACKFACE RADIUS FRONTFACE CHAMFER
*NP457202	38.100 1.5000	29.771 1.1721	.8 .03	NP472053	104.775 4.1250	28.575 1.1250	3.3 .13	NP457202: FRONTFACE CHAMFER
NP461086	53.700 2.1142	31.000 1.2205	3.0 .12	NP477660	47.000 1.8504	11.500 .4528	.6 .03	NP461086: HOLES IN BACKFACE
NP463799	35.000 1.3780	23.000 .9055	1.5 .06					NP463799: FRONTFACE CHAMFER
NP464541	50.800 2.0000	44.450 1.7500	3.5 .14					NP468643: EXTENDED SMALL RIB
*NP468643	365.600 14.3937	140.000 5.5118	2.5 .10					
*NP479278	30.000 1.1811	17.000 .6693	1.0 .04					NP479278: FRONTFACE CHAMFER
NP483022	49.212 1.9375	44.475 1.7510	3.5 .14					
*NP483277	68.000 2.6772	60.870 2.3964	.8 .03					NP483277: FRONTFACE CHAMFER EXTENDED SMALL RIB
NP484279	45.000 1.7717	19.840 .7812	1.8 .07					EXTENDED LARGE RIB
NP492308	89.974 3.5423	40.000 1.5748	7.0 .28					

\*\*These Maximum Fillet Radii will be cleared by the Cone or Cup Radii.  
\* See Remarks Column.

NP Parts are made for specific applications.  
XC Parts are in limited production.

13

**NP and XC PARTS**

CONE			Max Shaft Fillet Radii R'	CUP			Max Hs'ng Fillet Radii r'	Remarks
Number	BORE d	WIDTH B		Number	OUTSIDE DIA D	WIDTH C		
NP498093	107.950	66.675	8.0	*NP497563	62.000	14.000	1.0	NP497563: BROKEN CORNER ON FRONTFACE OD
	4.2500	2.6250	.31		2.4409	.5512	.04	
NP512245	234.950	49.212	6.4	NP498148	304.800	57.150	6.4	NP499336: GROOVE IN OD CENTER HOLES IN OD CENTER
					12.0000	2.2500	.25	
				*NP499336	219.873	155.000	N/A	NP510716: CHAMFER ON FRONTFACE OD
					8.6564	6.1024	N/A	
				*NP510716	52.000	18.000	1.0	NP514720
					2.0472	.7087	.04	
					292.100	46.038	3.3	NP516315
					11.5000	1.8125	.13	
								NP516946: FRONTFACE CHAMFER
								NP518547: FRONTFACE CHAMFER
								NP520058: REVERSE TAPERED BORE
								NP520308
								NP522505
								NP528245: FRONTFACE CHAMFER
								NP531592
								NP535811
								*NP536440
								*NP540329
								NP542200
								NP545492
								NP549434
								*NP555508
								NP557248
								NP561514
								NP561905
								*NP562664
								NP573074
								NP575780
								*NP576479
								*NP586296
								*NP587110

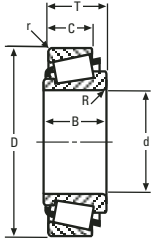

**SINGLE ROW**

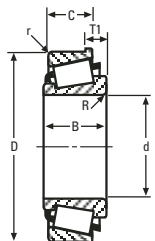

**SINGLE ROW WITH FLANGE**

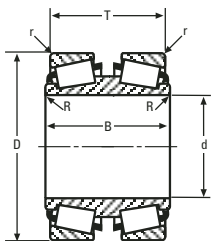

**DOUBLE CONE**

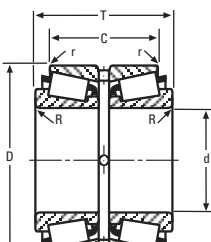

**DOUBLE CUP**

**13**

NP Parts are made for specific applications.  
XC Parts are in limited production.

\*\*These Maximum Fillet Radii will be cleared by the Cone or Cup Radii.  
\* See Remarks Column.

NP and XC PARTS

CONE			Max Shaft Fillet Radii R'	CUP			Max Hs'ng Fillet Radii r'	Remarks
Number	BORE d	WIDTH B		Number	OUTSIDE DIA D	WIDTH C		
				NP592766	75.000 2.9528	15.500 .6102	1.5 .06	
				*NP594918	59.530 2.3437	18.288 .7200	1.5 .06	NP594918: KEYWAY IN OD BACKFACE
				*NP595979	100.000 3.9370	37.000 1.4567	N/A N/A	NP595979: CHAMFER ON RIGHTFACE OD CHAMFER ON LEFTFACE OD
				NP597926	100.000 3.9370	36.510 1.4375	.8 .03	
NP599945	133.350 5.2500	63.500 2.5000	9.7 .38					
NP600001	85.000 3.3465	28.000 1.1024	2.5 .10					
NP600920	119.957 4.7227	57.500 2.2638	1.5 .06					
*NP601751	66.675 2.6250	21.996 .8660	3.5 .14					NP601751: FRONTFACE CHAMFER
				NP603591	73.025 2.8750	23.020 .9063	3.3 .13	
NP606435	117.475 4.6250	31.750 1.2500	8.0 .31					
				NP607075	110.000 4.3307	18.824 .7411	1.3 .05	
				NP611161	74.976 2.9518	14.000 .5512	1.5 .06	
				NP614635	120.000 4.7244	26.195 1.0313	3.3 .13	
				NP621715	447.675 17.6250	68.262 2.6875	3.3 .13	
*NP622187	30.000 1.1811	17.000 .6693	1.0 .04					NP622187: FRONTFACE CHAMFER
*NP623529	37.000 1.4567	38.000 1.4961	2.0 .08					NP623529: FRONTFACE CHAMFER EXTENDED LARGE RIB
NP624111	180.000 7.0866	64.000 2.5197	3.5 .14					
NP626468	50.000 1.9685	20.000 .7874	3.5 .14					
				NP628202	250.000 9.8425	37.000 1.4567	2.5 .10	
				*NP631090	234.950 9.2500	114.300 4.5000	1.5 .06	NP631090: GROOVE IN OD CENTER HOLES IN OD CENTER
NP636046	25.400 1.0000	23.114 .9100	.8 .03					
*NP638318	25.000 .9843	15.000 .5906	1.0 .04					NP638318: FRONTFACE CHAMFER
				*NP638413	108.000 4.2520	29.250 1.1516	.5 .02	NP638413: FLANGE ON OD FRONTFACE, BEARING WIDTH IS T1 DIMENSION
*NP639164	385.762 15.1875	158.750 6.2500	3.3 .13					NP639164: ASYMMETRICAL BEARING
				NP645406	64.976 2.5581	14.000 .5512	1.3 .05	
				*NP646130	90.000 3.5433	49.000 1.9291	1.5 .06	NP646130: ASYMMETRICAL - TWO SERIES BEARING GROOVE IN OD LEFTFACE
				NP646352	50.005 1.9687	13.970 .5500	1.3 .05	FLANGE ON OD RIGHTFACE CHAMFER ON RIGHTFACE OD
				NP646664	80.000 3.1496	25.000 .9843	1.5 .06	CHAMFER ON LEFTFACE OD
				NP659482	65.088 2.5625	13.970 .5500	1.3 .05	NP660452: CHAMFER ON RIGHTFACE OD CHAMFER ON LEFTFACE OD
				*NP660452	80.000 3.1496	30.000 1.1811	N/A N/A	
NP660566	133.350 5.2500	46.038 1.8125	3.5 .14					
*NP660946	550.000 21.6535	150.000 5.9055	3.5 .14					NP660946: GROOVE IN ID

\*\*These Maximum Fillet Radii will be cleared by the Cone or Cup Radii.  
\* See Remarks Column.

NP Parts are made for specific applications.  
XC Parts are in limited production.

13

**NP and XC PARTS**

CONE			Max Shaft Fillet Radii R'	CUP			Max Hs'ng Fillet Radii r'	Remarks
Number	BORE d	WIDTH B		Number	OUTSIDE DIA D	WIDTH C		
				NP665055	190.500	46.038	3.3	
					7.5000	1.8125	.13	
				NP666842	68.000	15.400	1.5	
					2.6772	.6063	.06	
				NP669027	180.095	39.000	2.5	
					7.0903	1.5354	.10	
				*NP669820	190.500	46.038	3.3	NP669820: FLANGE ON OD FRONTFACE, BEARING WIDTH IS T1 DIMENSION
					7.5000	1.8125	.13	
				NP673108	99.974	42.000	5.0	NP673108: FRONTFACE CHAMFER
					3.9360	1.6535	.20	
				NP673791	15.875	14.288	1.5	
					.6250	.5625	.06	
				NP674634	69.850	25.400	1.5	
					2.7500	1.0000	.06	
				NP681933	65.088	46.038	3.5	
					2.5625	1.8125	.14	
				NP686631	120.650	82.550	9.7	
					4.7500	3.2500	.38	
				*NP687057	253.906	144.018	1.0	NP687057: ASYMMETRICAL BEARING CHAMFER ON LEFTFACE OD CHAMFER ON RIGHTFACE OD KEYWAY IN OD CENTER
					9.9963	5.6700	.04	
				NP688738	42.862	17.145	1.5	NP688738: FRONTFACE CHAMFER
					1.6875	.6750	.06	
				NP688898	480.000	76.000	5.0	
					18.8976	2.9921	.20	
				*NP693218	56.560	12.000	1.0	NP688796: GROOVE IN OD CENTER
					2.2268	.4724	.04	
				*NP693852	59.131	12.000	1.0	NP693218: FLANGE ON OD FRONTFACE, BEARING WIDTH IS T1 DIMENSION CHAMFER ON FRONTFACE OD
					2.3280	.4724	.04	
				NP694563	41.275	36.512	1.5	
					1.6250	1.4375	.06	
				NP697931	88.900	49.212	3.5	NP693852: CHAMFER ON FRONTFACE OD FLANGE ON OD FRONTFACE, BEARING WIDTH IS T1 DIMENSION
					3.5000	1.9375	.14	
				NP698197	95.250	22.225	.8	
					3.7500	.8750	.03	
				NP700413	460.000	76.000	5.0	
					18.1102	2.9921	.20	
				NP701655	60.325	44.450	3.5	
					2.3750	1.7500	.14	
				*NP702249	29.000	17.590	2.3	NP702249: EXTENDED SMALL RIB
					1.1417	.6925	.09	
				NP703773	41.275	36.512	1.5	
					1.6250	1.4375	.06	
				NP707669	68.262	46.038	3.5	
					2.6875	1.8125	.14	
				NP708326	44.450	36.512	3.5	
					1.7500	1.4375	.14	
				NP709900	482.600	52.388	3.3	
					19.0000	2.0625	.13	
				NP712475	85.026	46.672	3.5	
					3.3475	1.8375	.14	

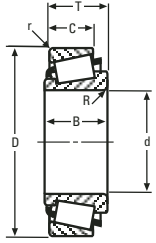

**SINGLE ROW**



**SINGLE ROW WITH FLANGE**

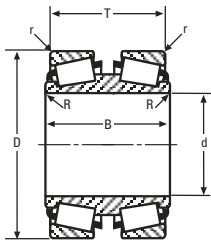

**DOUBLE CONE**

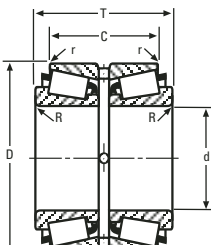

**DOUBLE CUP**

**13**

NP Parts are made for specific applications.  
XC Parts are in limited production.

\*\*These Maximum Fillet Radii will be cleared by the Cone or Cup Radii.  
\* See Remarks Column.



NP and XC PARTS

CONE			Max Shaft Fillet Radii R <sup>1</sup>	CUP			Max Hs'ng Fillet Radii r <sup>1</sup>	Remarks
Number	BORE d	WIDTH B		Number	OUTSIDE DIA D	WIDTH C		
*NP712550	40.000 1.5748	23.000 .9055	1.5 .06					NP712550: FRONTFACE CHAMFER
*NP712745	119.913 4.7210	38.936 1.5329	3.5 .14					NP712745: TAPERED BORE
*NP714822	40.000 1.5748	33.000 1.2992	4.0 .16					NP714822: FRONTFACE CHAMFER
*NP715284	50.000 1.9685	20.000 .7874	2.3 .09					NP715284: FRONTFACE CHAMFER
				NP715448	254.000 10.0000	33.338 1.3125	3.3 .13	
				NP717379	105.000 4.1339	18.500 .7283	1.0 .04	
				NP717996	130.000 5.1181	24.000 .9449	2.5 .10	
				NP719416	546.100 21.5000	82.550 3.2500	6.4 .25	
				NP721559	141.000 5.5512	22.000 .8661	2.0 .08	
*NP726878	45.242 1.7812	27.419 1.0795	3.5 .14					NP726878: EXTENDED SMALL RIB
*NP727766	57.165 2.2506	26.150 1.0295	.8 .03					NP727766: FRONTFACE CHAMFER
*NP731186	254.000 10.0000	71.438 2.8125	3.5 .14					NP731186: KEYWAY IN ID FRONTFACE
				NP733999	59.131 2.3280	11.938 .4700	1.3 .05	
				NP735186	158.750 6.2500	15.875 .6250	3.3 .13	
				*NP736722	130.000 5.1181	45.000 1.7717	N/A N/A	NP736722: CHAMFER ON RIGHTFACE OD CHAMFER ON LEFTFACE OD
*NP737697	50.000 1.9685	20.000 .7874	3.0 .12					NP737697: FRONTFACE CHAMFER
NP738483	133.350 5.2500	63.500 2.5000	9.7 .38					
				NP738729	69.012 2.7170	15.083 .5938	2.3 .09	
NP739395	101.600 4.0000	66.675 2.6250	7.0 .28					
				NP739603	447.675 17.6250	68.262 2.6875	3.3 .13	
				NP742024	190.500 7.5000	46.038 1.8125	1.5 .06	
				NP742592	67.975 2.6762	13.500 .5315	1.5 .06	
NP747110	60.325 2.3750	43.764 1.7230	3.5 .14					
*NP748283	49.212 1.9375	44.450 1.7500	3.5 .14					NP748283: FRONTFACE CHAMFER
				*NP748655	64.200 2.5276	13.970 .5500	1.3 .05	NP748655: FLANGE ON OD FRONTFACE, BEARING WIDTH IS T1 DIMENSION CHAMFER ON FRONTFACE OD
				NP750751	80.000 3.1496	22.665 .8923	1.5 .06	
				*NP750997	61.986 2.4404	14.732 .5800	1.5 .06	NP750997: FLANGE ON OD FRONTFACE, BEARING WIDTH IS T1 DIMENSION CHAMFER ON FRONTFACE OD
*NP751516	38.100 1.5000	29.771 1.1721	3.5 .14					NP751516: FRONTFACE CHAMFER
				NP758445	254.000 10.0000	47.625 1.8750	3.3 .13	
				NP761714	73.431 2.8910	14.732 .5800	.8 .03	
				NP762896	80.000 3.1496	15.500 .6102	1.0 .04	
				NP763848	80.040 3.1512	15.500 .6102	1.0 .04	
*NP765903	30.000 1.1811	17.000 .6693	1.5 .06					NP765903: FRONTFACE CHAMFER

\*These Maximum Fillet Radii will be cleared by the Cone or Cup Radii.  
\* See Remarks Column.

NP Parts are made for specific applications.  
XC Parts are in limited production.

**NP and XC PARTS**

CONE			Max Shaft Fillet Radii R'	CUP			Max Hs'ng Fillet Radii r'	Remarks
Number	BORE d	WIDTH B		Number	OUTSIDE DIA D	WIDTH C		
*NP766253	90.000 3.5433	62.755 2.4706	10.0 .39					NP766253: SPECIAL SMALL RIB EXTENDED SMALL RIB
NP769363	63.500 2.5000	38.354 1.5100	3.5 .14					SHOULDER ON ID BACKFACE GROOVE IN ID FRONTFACE
*NP774232	446.204 17.5671	233.045 9.1750	3.3 .13	NP777052	168.275 6.6250	41.275 1.6250	3.3 .13	NP774232: NO SMALL RIB TAPERED BORE NO LARGE RIB
NP780054	129.967 5.1168	68.715 2.7053	3.3 .13					
NP781752	61.000 2.4016	35.000 1.3780	3.0 .12					
*NP787790	40.000 1.5748	32.000 1.2598	1.5 .06	*NP787502	202.000 7.9528	101.000 3.9764	1.0 .04	NP787502: HOLES IN OD CENTER SHOULDER ON OD LEFTFACE ASYMMETRICAL BEARING CHAMFER ON RIGHTFACE OD
*NP797917	50.800 2.0000	36.068 1.4200	.8 .03	NP794104	136.525 5.3750	38.100 1.5000	1.5 .06	NP794104: GROOVE IN OD CENTER FLANGE ON OD LEFTFACE CHAMFER ON LEFTFACE OD
NP799347	85.026 3.3475	46.672 1.8375	3.5 .14					NP787790: FRONTFACE CHAMFER
*NP819171	45.987 1.8105	18.000 .7087	2.3 .09	NP801481	59.530 2.3437	18.288 .7200	1.5 .06	NP797917: FRONTFACE CHAMFER
NP821977	177.800 7.0000	53.975 2.1250	8.0 .31	*NP807769	127.000 5.0000	29.000 1.1417	2.5 .10	NP807769: CHAMFER ON FRONTFACE OD
NP822100	26.500 1.0433	14.732 .5800	3.5 .14	*NP810997	65.000 2.5591	14.525 .5718	.5 .02	NP810997: SHOULDER ON OD BACKFACE CHAMFER ON BACKFACE OD CHAMFER ON FRONTFACE OD
*NP823007	107.950 4.2500	21.438 .8440	3.5 .14	NP819244	150.089 5.9090	36.512 1.4375	1.5 .06	NP819244: FRONTFACE CHAMFER
NP823021	317.500 12.5000	85.725 3.3750	3.5 .14					NP823007: FRONTFACE CHAMFER
*NP824422	34.988 1.3775	16.764 .6600	spcl. spcl.					NP824422: SPECIAL BACKFACE RADIUS
NP825236	200.000 7.8740	62.000 2.4409	3.5 .14	NP825371	562.000 22.1260	77.788 3.0625	6.4 .25	
NP830648	390.000 15.3543	180.000 7.0866	2.0 .08	NP831700	103.188 4.0625	36.512 1.4375	3.3 .13	
*NP833746	115.087 4.5310	62.819 2.4732	3.5 .14					NP833746: FRONTFACE CHAMFER EXTENDED LARGE RIB GROOVE IN OD BACKFACE
NP835067	47.625 1.8750	24.448 .9625	3.5 .14	NP836838	130.000 5.1181	26.350 1.0374	2.5 .10	
*NP837197	45.987 1.8105	18.000 .7087	2.3 .09					NP837197: FRONTFACE CHAMFER
*NP837704	247.650 9.7500	63.500 2.5000	6.4 .25					NP837704: KEYWAY IN ID FRONTFACE
*NP838887	50.000 1.9685	20.000 .7874	2.3 .09					NP838887: FRONTFACE CHAMFER
NP839980	133.350 5.2500	63.500 2.5000	9.7 .38	*NP840431	55.000 2.1654	12.550 .4941	1.0 .04	NP840431: CHAMFER ON FRONTFACE OD

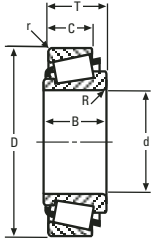

**SINGLE ROW**



**SINGLE ROW WITH FLANGE**

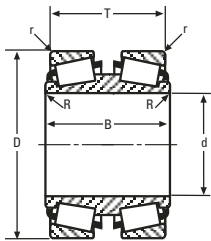

**DOUBLE CONE**

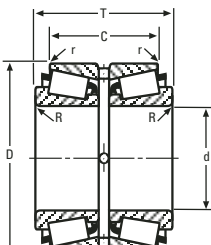

**DOUBLE CUP**

**13**

NP Parts are made for specific applications.  
XC Parts are in limited production.

\*\*These Maximum Fillet Radii will be cleared by the Cone or Cup Radii.  
\* See Remarks Column.

NP and XC PARTS

CONE			Max Shaft Fillet Radii R <sup>1</sup>	CUP			Max Hs'ng Fillet Radii r <sup>1</sup>	Remarks
Number	BORE d	WIDTH B		Number	OUTSIDE DIA D	WIDTH C		
				NP841384	111.125 4.3750	20.638 .8125	3.3 .13	
NP844601	71.438 2.8125	32.545 1.2813	3.5 .14					
*NP846650	75.000 2.9528	28.000 1.1024	.6 .03					NP846650: FRONTFACE CHAMFER
				NP847247	112.712 4.4375	19.050 .7500	3.3 .13	
*NP849042	240.000 9.4488	39.000 1.5354	3.0 .12					NP849042: FRONTFACE CHAMFER
NP850232	45.915 1.8077	18.000 .7087	2.3 .09					
				NP850439	62.000 2.4409	14.288 .5625	1.3 .05	
NP851052	82.550 3.2500	46.672 1.8375	3.5 .14					
NP851626	25.400 1.0000	14.732 .5800	1.3 .05					
				NP851934	106.000 4.1732	13.170 .5185	1.0 .04	
				NP852290	65.088 2.5625	13.970 .5500	1.3 .05	
NP853879	77.788 3.0625	48.702 1.9174	3.5 .14					
NP853900	101.600 4.0000	34.925 1.3750	.8 .03					
				NP854000	149.898 5.9015	26.988 1.0625	3.3 .13	
				NP854835	655.000 25.7874	70.000 2.7559	3.3 .13	
				NP859261	136.525 5.3750	36.512 1.4375	3.3 .13	
NP859982	180.000 7.0866	45.000 1.7717	3.0 .12					
NP861151	38.500 1.5157	18.000 .7087	2.5 .10					
				NP862174	85.700 3.3740	15.875 .6250	1.5 .06	
				NP863447	74.976 2.9518	14.000 .5512	1.5 .06	
				NP863766	355.600 14.0000	44.450 1.7500	3.3 .13	
*NP864263	45.000 1.7717	21.625 .8514	spcl. spcl.					NP864263: FRONTFACE CHAMFER BACKFACE CHAMFER
NP864314	50.800 2.0000	36.512 1.4375	3.5 .14					
				NP865283	104.775 4.1250	28.575 1.1250	3.3 .13	
NP867201	21.986 .8656	18.288 .7200	1.3 .05					
NP869339	70.000 2.7559	29.000 1.1417	3.0 .12					
NP871543	68.262 2.6875	21.996 .8660	2.3 .09					
				NP876594	150.089 5.9090	36.512 1.4375	1.5 .06	
*NP877824	157.150 6.1870	84.531 3.3280	1.0 .04					NP877824: EXTENDED LARGE RIB SHOULDER ON ID BACKFACE SPECIAL BORE
NP880810	22.225 .8750	20.221 .7961	1.5 .06					
NP881228	26.988 1.0625	14.732 .5800	3.5 .14					
*NP881387	65.000 2.5591	33.000 1.2992	1.0 .04					NP881387: FRONTFACE CHAMFER
NP882248	114.300 4.5000	66.675 2.6250	7.0 .28					

\*\*These Maximum Fillet Radii will be cleared by the Cone or Cup Radii.  
\* See Remarks Column.

NP Parts are made for specific applications.  
XC Parts are in limited production.

13

**NP and XC PARTS**

CONE			Max Shaft Fillet Radii R'	CUP			Max Hs'ng Fillet Radii r'	Remarks
Number	BORE d	WIDTH B		Number	OUTSIDE DIA D	WIDTH C		
NP883948	114.300 4.5000	66.675 2.6250	7.0 .28	NP885315	62.000 2.4409	14.000 .5512	1.5 .06	NP890996: GROOVE IN OD CENTER HOLES IN OD CENTER
				*NP890996	229.873 9.0501	150.000 5.9055	N/A N/A	
				NP891538	110.000 4.3307	15.500 .6102	2.0 .08	
NP897661	53.700 2.1142	29.145 1.1475	3.0 .12	NP901205	260.350 10.2500	41.275 1.6250	3.3 .13	
NP904081	42.070 1.6563	40.386 1.5900	3.5 .14	NP901641	130.000 5.1181	35.000 1.3780	2.5 .10	
NP904811	44.450 1.7500	26.909 1.0594	3.5 .14	NP905784	80.000 3.1496	18.740 .7377	.8 .03	NP907899: ASYMMETRICAL BEARING GROOVE IN ID
*NP907899	510.000 20.0787	188.500 7.4213	1.5 .06	NP908060	150.000 5.9055	24.000 .9449	1.5 .06	NP909358: FRONTFACE CHAMFER
*NP909358	40.000 1.5748	22.403 .8820	3.5 .14	NP909855	146.975 5.7864	32.500 1.2795	3.5 .14	
NP910415	44.450 1.7500	25.400 1.0000	3.5 .14	NP912541	514.350 20.2500	63.500 2.5000	3.3 .13	
				NP918319	50.292 1.9800	10.668 .4200	1.3 .05	
				NP918734	212.725 8.3750	53.975 2.1250	3.3 .13	
NP921376	77.788 3.0625	48.702 1.9174	3.5 .14					
NP921847	100.000 3.9370	46.000 1.8110	3.0 .12					
NP928058	100.000 3.9370	32.000 1.2598	2.0 .08					
NP929079	43.000 1.6929	30.000 1.1811	2.0 .08					
NP936041	231.775 9.1250	65.088 2.5625	6.4 .25					
*NP938901	45.987 1.8105	18.000 .7087	spcl. spcl.					NP938901: FRONTFACE CHAMFER SPECIAL BACKFACE RADIUS
NP946192	44.450 1.7500	23.012 .9060	.8 .03					
NP946311	34.925 1.3750	24.608 .9688	1.5 .06	NP946363	55.000 2.1654	13.000 .5118	1.5 .06	NP946473: BROKEN CORNER ON FRONTFACE OD
				*NP946473	62.000 2.4409	14.000 .5512	1.0 .04	NP947791: FRONTFACE CHAMFER
*NP947791	50.000 1.9685	32.000 1.2598	1.5 .06					
NP950329	482.000 18.9764	160.000 6.2992	3.3 .13					
NP951065	31.750 1.2500	27.783 1.0938	1.3 .05	NP953787	62.000 2.4409	12.750 .5020	1.0 .04	NP956328: SPECIAL BACKFACE RADIUS
*NP956328	40.988 1.6137	18.000 .7087	spcl. spcl.					

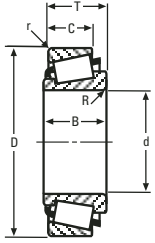

**SINGLE ROW**



**SINGLE ROW WITH FLANGE**

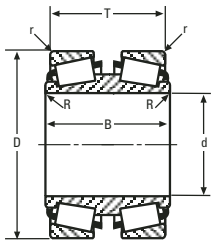

**DOUBLE CONE**

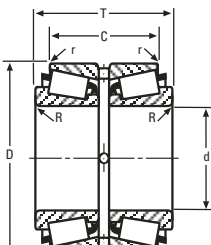

**DOUBLE CUP**

**13**

NP Parts are made for specific applications.  
XC Parts are in limited production.

\*\*These Maximum Fillet Radii will be cleared by the Cone or Cup Radii.  
\* See Remarks Column.

NP and XC PARTS

CONE			Max Shaft Fillet Radii R <sup>1</sup>	CUP			Max Hs'ng Fillet Radii r <sup>1</sup>	Remarks
Number	BORE d	WIDTH B		Number	OUTSIDE DIA D	WIDTH C		
*NP959165	34.925 1.3750	18.288 .7200	spcl. spcl.	NP957262	127.000 5.0000	34.925 1.3750	3.3 .13	NP958022: HOLES IN OD CENTER GROOVE IN OD CENTER  NP959165: SPECIAL BACKFACE RADIUS  NP959605: SHOULDER ON OD FRONTFACE HOLES IN OD FRONTFACE CHAMFER ON FRONTFACE OD SPECIAL CHAMFER ON BACKFACE OD  NP96708: HOLES IN OD FRONTFACE CHAMFER ON BACKFACE OD  NP964528: HOLES IN OD CENTER GROOVE IN OD CENTER  NP972022: FRONTFACE CHAMFER  NP975152: SHOULDER ON OD BACKFACE CHAMFER ON BACKFACE OD CHAMFER ON FRONTFACE OD  NP975615: EXTENDED LARGE RIB FRONTFACE CHAMFER EXTENDED SMALL RIB  NP980605: FRONTFACE CHAMFER  NP980976: GROOVE IN ID FRONTFACE SHOULDER ON ID FRONTFACE FRONTFACE CHAMFER  NP988748: FRONTFACE CHAMFER  NP995460: GROOVE IN ID FRONTFACE EXTENDED SMALL RIB EXTENDED LARGE RIB
				*NP958022	187.325 7.3750	93.660 3.6874	1.5 .06	
				*NP959605	635.000 25.0000	112.649 4.4350	spcl. spcl.	
				NP959807	57.175 2.2510	15.875 .6250	1.5 .06	
				*NP960708	635.000 25.0000	115.570 4.5500	6.4 .25	
				NP961542	161.925 6.3750	38.100 1.5000	3.3 .13	
				NP962387	80.000 3.1496	15.500 .6102	1.0 .04	
				NP963662	50.800 2.0000	22.225 .8750	3.5 .14	
				NP965020	170.000 6.6929	46.038 1.8125	4.8 .19	
				*NP972022	80.000 3.1496	46.000 1.8110	6.0 .24	
NP972299	50.800 2.0000	28.575 1.1250	3.5 .14					
NP972505	381.000 15.0000	104.775 4.1250	6.4 .25					
*NP975152	68.000 2.6772	60.870 2.3964	.8 .03	NP975152	65.000 2.5591	14.525 .5718	.5 .02	
				NP975201	150.089 5.9090	36.512 1.4375	3.3 .13	
*NP975615	68.000 2.6772	60.870 2.3964	.8 .03					
*NP980605	30.000 1.1811	16.700 .6575	1.0 .04					
*NP980976	40.000 1.5748	27.500 1.0827	4.3 .17					
NP981262	120.650 4.7500	47.625 1.8750	3.3 .13					
NP981435	76.200 3.0000	57.531 2.2650	3.5 .14	NP981435	266.700 10.5000	38.100 1.5000	3.3 .13	
				NP984494	65.088 2.5625	13.970 .5500	1.3 .05	
NP987549	76.200 3.0000	57.531 2.2650	3.5 .14					
*NP988748	57.165 2.2506	26.150 1.0295	.8 .03					
NP993044	88.900 3.5000	57.531 2.2650	8.0 .31					
*NP995460	82.000 3.2283	55.255 2.1753	10.0 .39					
NP999210	25.400 1.0000	23.114 .9100	.8 .03					

\*\*These Maximum Fillet Radii will be cleared by the Cone or Cup Radii.  
\* See Remarks Column.

NP Parts are made for specific applications.  
XC Parts are in limited production.

# AUXILIARY PARTS – CUP SHIMS

## Standard Metal Shims for Cup Adjusted Bearings

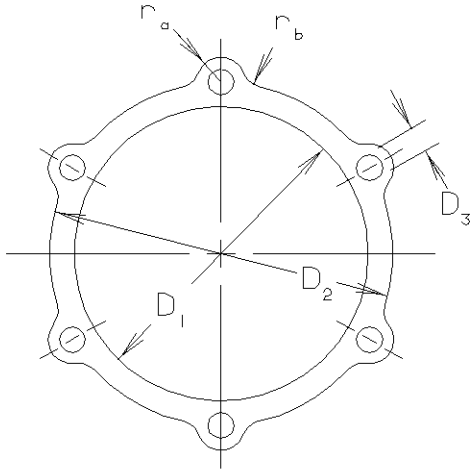

Shims are **0.13 mm** (0.005 in.), **0.18 mm** (0.007 in) and **0.51 mm** (0.020 in.) thick

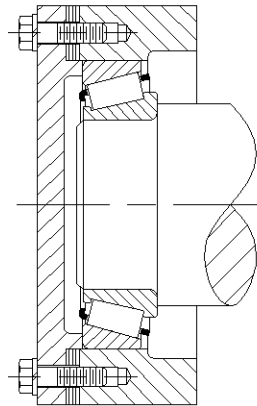

without carrier

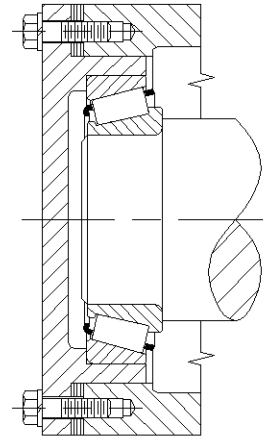

with carrier

Carrier section should be equal to average cup wall section.

Suggested shim sets consist of three **0.13 mm** (0.005 in.), three **0.18 mm** (0.007 in), and one **0.51 mm** (0.020 in.) thick shims. When ordering, specify the exact quantity for each part number. Shims shown in this table are made from aluminum.

**Cup Shims**  
part number identifies the following:  
thickness (inches)  
00 00  
example  
K2 06 05 Covers number 6 shim **0.13** (0.005 in.) thick (blue)  
K2 06 07 Covers number 6 shim **0.18** (0.007 in.) thick (silver)  
K2 06 20 Covers number 6 shim **0.51** (0.020 in.) thick (yellow)

shim part numbers			cap screws		D <sub>1</sub>	D <sub>2</sub>	D <sub>3</sub>	r <sub>a</sub>	r <sub>b</sub>	shim part numbers			cap screws		D <sub>1</sub>	D <sub>2</sub>	D <sub>3</sub>	r <sub>a</sub>	r <sub>b</sub>
0.13 0.005 thick	0.18 0.007 thick	0.51 0.020 thick	no.	size						0.13 0.005 thick	0.18 0.007 thick	0.51 0.020 thick	no.	size					
K20605	K20607	K20620	4	6.4 0.25	35.8 1.41	47.8 1.88	7.1 0.28	6.4 0.25	3.0 0.12	K21605	K21607	K21620	4	12.7 0.50	102.4 4.03	127.0 5.00	13.5 0.53	12.7 0.50	6.4 0.25
K20705	K20707	K20720	4	6.4 0.25	45.2 1.78	57.2 2.25	7.1 0.28	6.4 0.25	3.0 0.12	K21705	K21707	K21720	4	12.7 0.50	108.7 4.28	133.4 5.25	13.5 0.53	12.7 0.50	6.4 0.25
K20805	K20807	K20820	4	9.7 0.38	51.6 2.03	69.8 2.75	10.4 0.41	9.7 0.38	4.8 0.19	K21805	K21807	K21820	4	12.7 0.50	115.1 4.53	139.7 5.50	13.5 0.53	12.7 0.50	6.4 0.25
K20905	K20907	K20920	4	9.7 0.38	59.4 2.34	76.2 3.00	10.4 0.41	9.7 0.38	4.8 0.19	K21905	K21907	K21920	6	12.7 0.50	121.4 4.78	146.0 5.75	13.5 0.53	12.7 0.50	6.4 0.25
K21005	K21007	K20920	4	9.7 0.38	65.8 2.34	82.6 3.25	10.4 0.41	9.7 0.38	4.8 0.19	K22005	K22007	K22020	6	12.7 0.50	127.8 5.03	152.4 6.00	13.5 0.53	12.7 0.50	6.4 0.25
K21105	K21107	K21120	4	9.7 0.38	70.6 2.78	88.9 3.50	10.4 0.41	9.7 0.38	4.8 0.19	K22205	K22207	K22220	6	12.7 0.50	140.5 5.53	165.1 6.50	13.5 0.53	12.7 0.50	6.4 0.25
K21405	K21407	K21420	4	9.7 0.38	89.7 3.53	108.0 4.25	10.4 0.41	9.7 0.38	4.8 0.19	K22405	K22407	K22420	6	12.7 0.50	153.2 6.03	177.8 7.00	13.5 0.53	12.7 0.50	6.4 0.25
K21505	K21507	K21520	4	9.7 0.38	96.0 3.78	114.3 4.50	10.4 0.41	9.7 0.38	4.8 0.19										

These parts have been designed and developed for use with Timken bearings only.

## AUXILIARY PARTS – CUP SHIMS

### Standard Metal Shims for Cup Adjusted Bearings

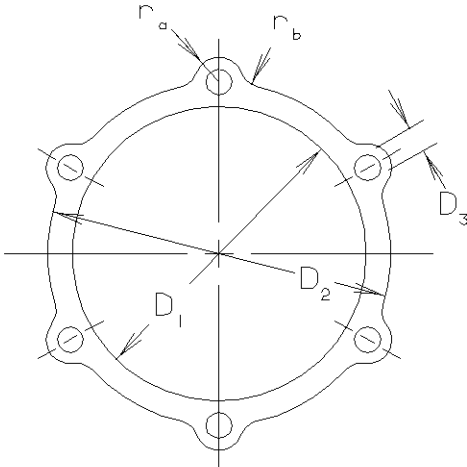

Shims are **0.13 mm** (0.005 in.), **0.18 mm** (0.007 in) and **0.51 mm** (0.020 in.) thick

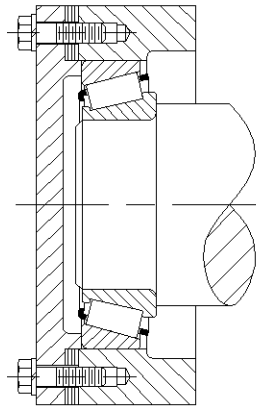

without carrier

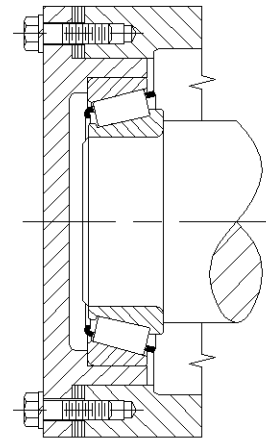

with carrier

Carrier section should be equal to average cup wall section.

Suggested shim sets consist of three **0.13 mm** (0.005 in.), three **0.18 mm** (0.007 in), and one **0.51 mm** (0.020 in.) thick shims. When ordering, specify the exact quantity for each part number. Shims shown in this table are made from aluminum.

**Cup Shims**  
part number identifies the following:  
shim size thickness (inches)  
K2 00 00  
example  
K2 06 05 Covers number 6 shim **0.13** (0.005 in.) thick (blue)  
K2 06 07 Covers number 6 shim **0.18** (0.007 in.) thick (silver)  
K2 06 20 Covers number 6 shim **0.51** (0.020 in.) thick (yellow)

shim part numbers			cap screws		D <sub>1</sub>	D <sub>2</sub>	D <sub>3</sub>	r <sub>a</sub>	r <sub>b</sub>	shim part numbers			cap screws		D <sub>1</sub>	D <sub>2</sub>	D <sub>3</sub>	r <sub>a</sub>	r <sub>b</sub>
0.13 0.005 thick	0.18 0.007 thick	0.51 0.020 thick	no.	size						0.13 0.005 thick	0.18 0.007 thick	0.51 0.020 thick	no.	size					
K22505	K22507	K22520	6	15.7 0.62	159.5 6.28	190.5 7.50	16.8 0.66	15.7 0.62	7.9 0.31	K23805	K23807	K23820	6	15.7 0.62	242.1 9.53	273.0 10.75	16.8 0.66	15.7 0.62	7.9 0.31
K22605	K22607	K22620	6	15.7 0.62	165.9 6.53	196.8 7.75	16.8 0.66	15.7 0.62	7.9 0.31	K24005	K24007	K24020	6	19.0 0.75	254.8 10.03	292.1 11.50	19.8 0.78	19.0 0.75	9.7 0.38
K22705	K22707	K22720	6	15.7 0.62	172.2 6.78	203.2 8.00	16.8 0.66	15.7 0.62	7.9 0.31	K24105	K24107	K24120	8	19.0 0.75	267.5 10.53	304.8 12.00	19.8 0.78	19.0 0.75	9.7 0.38
K22905	K22907	K22920	6	15.7 0.62	184.9 7.28	215.9 8.50	16.8 0.66	15.7 0.62	7.9 0.31	K24205	K24207	K24220	8	19.0 0.75	296.2 11.66	333.2 13.12	19.8 0.78	19.0 0.75	9.7 0.38
K23005	K23007	K23020	6	15.7 0.62	191.3 7.53	222.2 8.75	16.8 0.66	15.7 0.62	7.9 0.31	K24405	K24407	K24420	8	19.0 0.75	318.3 12.53	355.6 14.00	19.8 0.78	19.0 0.75	9.7 0.38
K23205	K23207	K23220	6	15.7 0.62	204.0 8.03	235.0 9.25	16.8 0.66	15.7 0.62	7.9 0.31	K24605	K24607	K24620	8	22.4 0.88	343.7 13.53	387.4 15.25	23.9 0.94	22.4 0.88	11.2 0.44
K23405	K23407	K23420	6	15.7 0.62	216.7 8.53	247.6 9.75	16.8 0.66	15.7 0.62	7.9 0.31	K24805	K24807	K24820	8	22.4 0.88	69.1 14.53	412.8 16.25	23.9 0.94	22.4 0.88	11.2 0.44
K23605	K23607	K23620	6	15.7 0.62	229.4 9.03	260.4 10.25	16.8 0.66	15.7 0.62	7.9 0.31	K25005	K25007	K25020	8	25.4 1.00	394.5 15.53	444.5 17.50	26.9 1.06	25.4 1.00	12.7 0.50
										K25005	K25007	K25020	8	25.4 1.00	419.9 16.53	469.9 18.50	26.9 1.06	25.4 1.00	12.7 0.50

These parts have been designed and developed for use with Timken bearings only.

**AUXILIARY PARTS – CONE SHIMS**  
**Standard Metal Shims for Cone Adjusted Bearings**

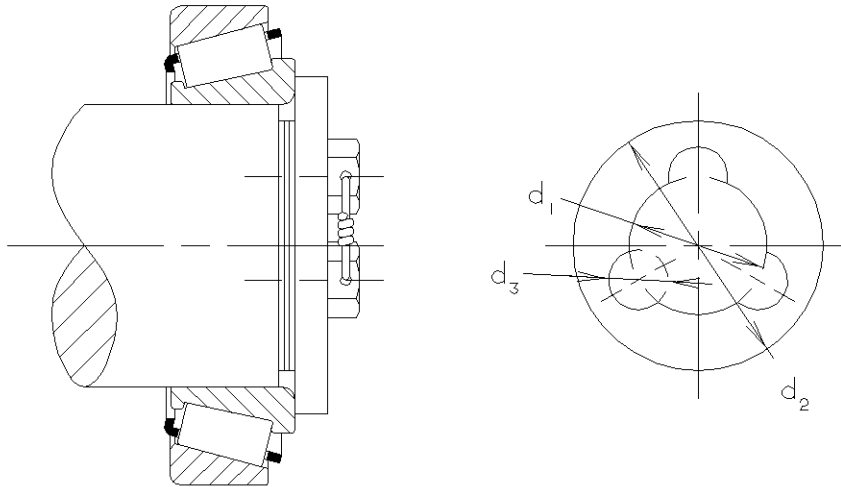

Suggested shim sets consist of three **0.13 mm** (0.005 in.) (blue), three **0.18 mm** (0.007 in.) (silver), and one **0.51 mm** (0.020 in.) (yellow) thick shims. When ordering, specify the exact quantity for each part number. Shims shown in this table are made from aluminum.

shims		shaft size	cap screws		d <sub>1</sub>	d <sub>2</sub>	d <sub>3</sub>	shims		shaft size	cap screws		d <sub>1</sub>	d <sub>2</sub>	d <sub>3</sub>
part number	thickness		no.	size				part number	thickness		no.	size			
T50605	0.13 0.005	63.5 2.50	3	12.7 0.50	35.1 1.38	60.5 2.38	14.2 0.56	T45882	0.13 0.005	108.0 4.25	3	15.7 0.62	76.2 3.00	103.1 4.06	17.5 0.69
T50606	0.18 0.007	to						T50633	0.18 0.007	to					
T50607	0.51 0.020	73.2 2.88						T45884	0.51 0.020	117.3 4.62					
T50608	0.13 0.005	76.2 3.00	3	12.7 0.50	44.4 1.75	73.2 2.88	14.2 0.56	T45885	0.13 0.005	120.6 4.75	3	15.7 0.62	88.9 3.50	117.3 4.62	17.5 0.69
T50609	0.18 0.007	to						T50634	0.18 0.007	to					
T50610	0.51 0.020	85.9 3.38						T45887	0.51 0.020	124.0 4.88					
T50611	0.13 0.005	8.9 3.50	3	12.7 0.50	57.2 2.25	85.9 3.38	14.2 0.56	T50614	0.13 0.005	127.0 5.00	4	19.0 0.75	88.9 3.50	124.0 4.88	20.6 0.81
T50612	0.18 0.007	to						T50615	0.18 0.007	to					
T50613	0.51 0.020	104.6 4.12						T50616	0.51 0.020	136.7 5.38					

These parts have been designed and developed for use with Timken bearings only.



## AUXILIARY PARTS – CONE SHIMS

### Standard Metal Shims for Cone Adjusted Bearings

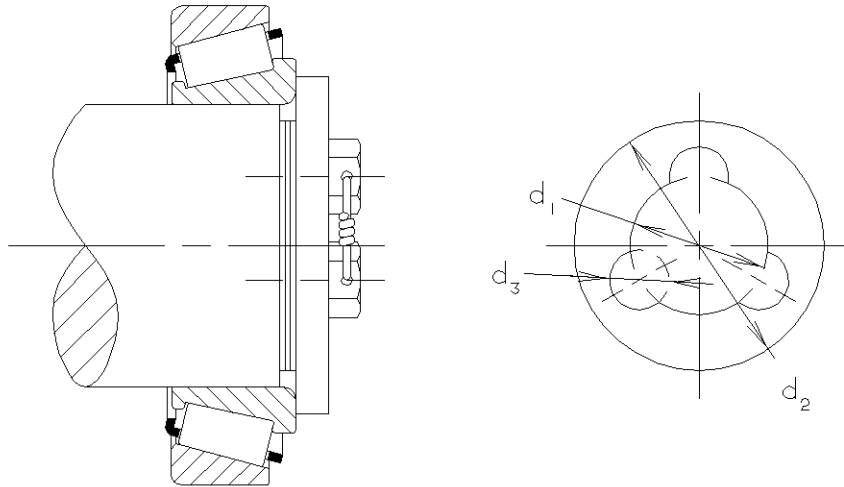

Suggested shim sets consist of three **0.13 mm** (blue) (0.005 in.), three **0.18 mm** (silver) (0.007 in.), and one **0.51 mm** (yellow) (0.020 in.) thick shims.  
 When ordering, specify the exact quantity for each part number.  
 Shims shown in this table are made from aluminum.

shims		shaft size	cap screws		d <sub>1</sub>	d <sub>2</sub>	d <sub>3</sub>	shims		shaft size	cap screws		d <sub>1</sub>	d <sub>2</sub>	d <sub>3</sub>
part number	thickness		no.	size				part number	thickness		no.	size			
T50617	0.13 0.005	139.7 5.50	4	19.0 0.75	88.9 3.50	136.7 5.38	20.6 0.81	T50623	0.13 0.005	177.8 7.00	6	25.4 1.00	127.0 5.00	174.8 6.88	26.9 1.06
T50618	0.18 0.007	to						T50624	0.18 0.007	200.2 7.88					
T50619	0.51 0.020	149.4 5.88						T50625	0.51 0.020						
T50620	0.13 0.005	152.7 6.00	6	19.0 0.75	101.6 4.00	149.4 5.88	20.6 0.81	T50626	0.13 0.005	203.2 8.00	6	31.8 1.25	152.4 6.00	200.2 7.88	33.3 1.31
T50621	0.18 0.007	to						T50627	0.18 0.007						
T50622	0.51 0.020	174.8 6.88						T50628	0.51 0.020						

**These parts have been designed and developed for use with Timken bearings only.**

## AUXILIARY PARTS – LOCKNUTS, LOCKWASHERS, AND TONGUED WASHERS

### Standard Locknut, Lockwasher, and Tongued Washer Assemblies

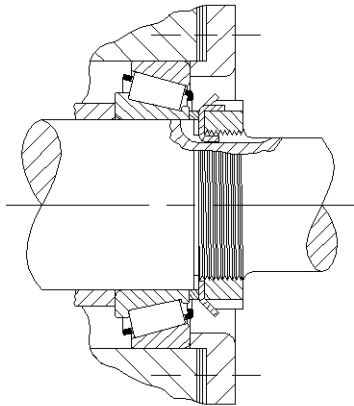

Figure 1

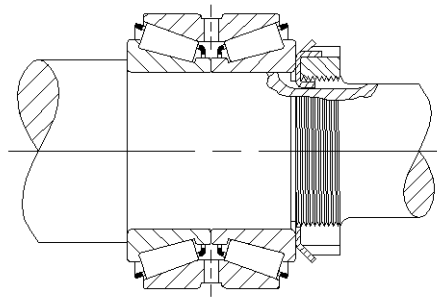

Figure 2

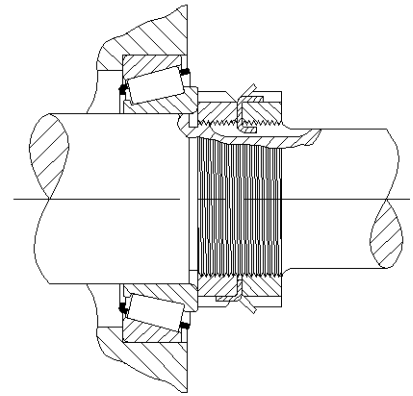

Figure 3

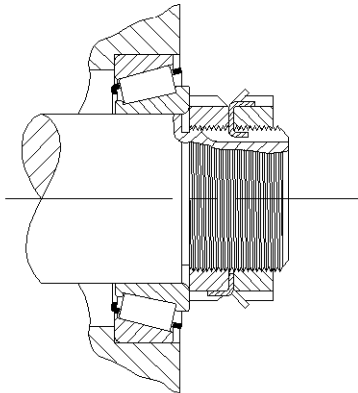

Figure 4

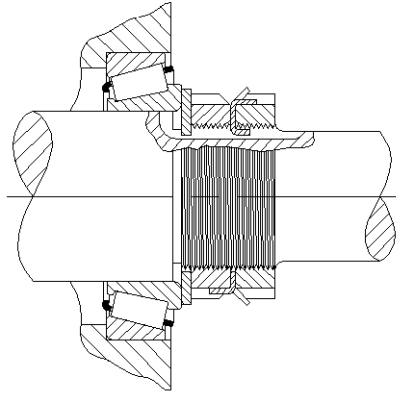

Figure 5

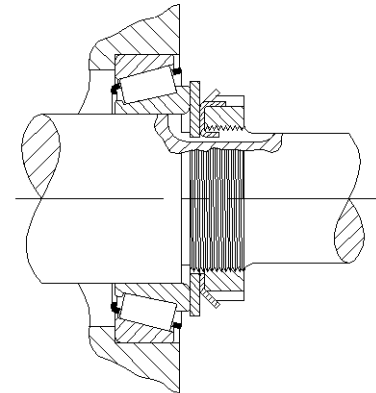

Figure 6

The designs shown in figures 1 to 6 inclusive show various methods of using standard locknuts, lockwashers, and tongued washers, indicated in the tables on pages 285 through 286. A single locknut and lockwasher can be used to clamp the cone against a sleeve, shown in figure 1, or directly against a shaft shoulder. A narrow spacer is applied between the front face of the cone and the lockwasher so that the lockwasher will clear the bearing cage by a minimum of 3mm (0.12 in). The spacer outside diameter should be made a minimum of 6mm (0.24 in) smaller than the cage inside diameter, but must still provide the recommended cone backing diameter as found in the Timken engineering journal. Figure 2 shows another clamped design using a single locknut and lockwasher with a two-row bearing of either type TDO with cone spacer or type TNA. Since no cage clearance problem is present, the narrow spacer shown in figure 1 is unnecessary.

Figures 3, 4, and 5 indicate an adjustable bearing arrangement using two locknuts and a lockwasher. These may be used with either single or two-row bearing of the types permitting a cone adjusted arrangement. The design in figure 3 allows the maximum shaft extension diameter that can be used with a shaft thread outside diameter, which will be less than the cone

bore. Figure 4 shows an alternate design with smaller thread diameter and corresponding smaller locknuts and lockwasher. The locknut outside diameter, minus 2 times "r" (pages 285 through 286), must not be less than the recommended cone backing diameter as found in the Timken engineering journal. Figure 5 indicates the use of a tongued washer located between the inner locknut and cone. This is intended for applications where the cones are applied with loose fits on hardened stationary shafts as found in many automotive applications. The hardened tongued washers are not sold by The Timken Company.

When space does not permit the use of two locknuts and a lockwasher in an adjustable arrangement, and a single locknut and a lockwasher is used, then a tongued washer must be placed between the cone and lockwasher as illustrated in figure 6. This is necessary to provide adequate backing for the cone, in most cases, and to prevent damage to the lockwasher if the cone should creep on the shaft. The tongued washers are available from The Timken Company.

**AUXILIARY PARTS – LOCKNUTS, LOCKWASHERS AND TONGUED WASHERS**

**Inch Design**

**Standard Locknuts, Lockwashers, and Tongued Washers for Tapered Roller Bearings**

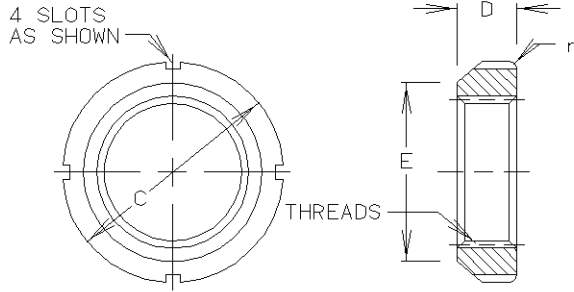

Figure 1 – Locknuts

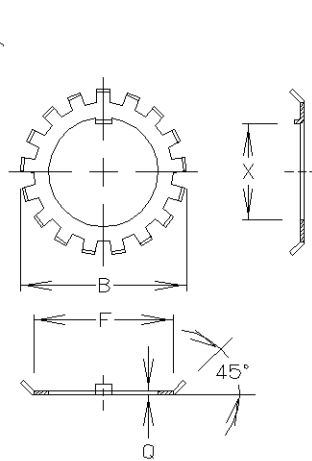

Figure 2 – Lockwashers

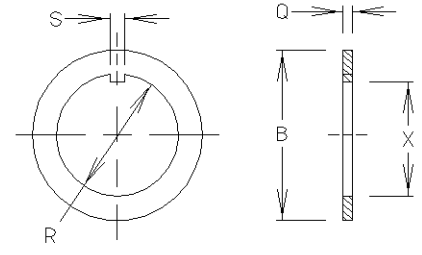

Figure 3 – Tongued Washers

Threads are American National, Form NS, Class 3, with thread length based on 45° chamfer.

ABMA locknut number	locknut dimensions						lockwasher dimensions					tongued washer dimensions						
	threads		outside diameter C	maximum thickness D	face outside diameter E	r	ABMA lockwasher number	maximum diameter over tangs B	face diameter F	thickness Q	number of tangs	tongued washer number	bore R		outside diameter B	minimum thickness Q	key	
	minimum value of major diameter	number per inch											min	max			S max	X min
N-00	0.391	32	0.755	0.229	0.625	0.047	TW100	0.891	0.625	0.032	9	K91500*	0.406	0.421	0.798	0.109	0.120	0.334
N-01	0.469	32	0.880	0.323	0.719	0.047	TW101	1.031	0.719	0.032	9	K91501	0.484	0.499	0.923	0.109	0.120	0.412
N-02	0.586	32	1.005	0.323	0.813	0.047	TW102	1.156	0.813	0.048	11	K91502	0.601	0.616	1.173	0.125	0.120	0.513
N-03	0.664	32	1.130	0.354	0.938	0.047	TW103	1.344	0.938	0.048	11	K91503	0.679	0.694	1.173	0.125	0.120	0.591
N-04	0.781	32	1.380	0.385	1.125	0.047	TW104	1.563	1.125	0.048	11	K91504	0.801	0.816	1.423	0.125	0.176	0.713
N-05	0.969	32	1.568	0.416	1.281	0.047	TW105	1.703	1.281	0.052	13	K91505	0.989	1.009	1.860	0.125	0.176	0.897
N-06	1.173	18	1.755	0.416	1.500	0.047	TW106	1.953	1.500	0.052	13	K91506	1.193	1.213	1.860	0.125	0.176	1.081
TN-065	1.312	18	2.068	0.448	1.813	0.063	TW065	2.234	1.813	0.052	15	K915065	1.333	1.353	2.173	0.125	0.176	1.221
TN-07	1.376	18	2.068	0.448	1.813	0.063	TW107	2.250	1.813	0.052	15	K91507	1.396	1.416	2.173	0.125	0.176	1.284
TN-08	1.563	18	2.255	0.448	2.000	0.063	TW108	2.484	2.000	0.062	15	K91508	1.583	1.603	2.735	0.156	0.290	1.461
TN-09	1.767	18	2.536	0.448	2.281	0.063	TW109	2.719	2.281	0.062	17	K91509	1.792	1.817	2.735	0.156	0.290	1.670
TN-10	1.967	18	2.693	0.510	2.438	0.063	TW110	2.922	2.438	0.062	17	K91510	1.992	2.017	3.235	0.156	0.290	1.870
TN-11	2.157	18	2.974	0.510	2.656	0.063	TW111	3.094	2.656	0.062	17	K91511	2.182	2.207	3.235	0.156	0.290	2.060
TN-12	2.360	18	3.161	0.541	2.844	0.063	TW112	3.328	2.844	0.072	17	K91512	2.400	2.425	3.735	0.187	0.290	2.248
TN-13	2.548	18	3.380	0.573	3.063	0.094	TW113	3.563	3.063	0.072	19	K91513	2.588	2.613	3.735	0.187	0.290	2.43
TN-14	2.751	18	3.630	0.573	3.313	0.094	TW114	3.813	3.313	0.072	19	K91514	2.791	2.816	3.735	0.187	0.290	2.639
TAN-15	2.933	12	3.880	0.604	3.563	0.094	TW115	4.047	3.563	0.085	19	K91515	2.973	3.003	4.173	0.218	0.290	2.808
TAN-16	3.137	12	4.161	0.604	3.844	0.094	TW116	4.391	3.844	0.085	19	K91516	3.177	3.207	4.173	0.218	0.353	3.012
TAN-17	3.340	12	4.411	0.635	4.031	0.094	TW117	4.625	4.031	0.085	19	K91517	3.395	3.425	4.610	0.218	0.353	3.230
TAN-18	3.527	12	4.661	0.698	4.281	0.094	TW118	4.953	4.281	0.115	19	K91518	3.582	3.612	5.110	0.250	0.353	3.387
TAN-19	3.730	12	4.943	0.729	4.562	0.125	TW119	5.234	4.563	0.115	19	K91519	3.800	3.830	5.110	0.250	0.353	3.605
TAN-20	3.918	12	5.193	0.760	4.813	0.125	TW120	5.484	4.813	0.115	19	K91520	3.988	4.018	5.610	0.250	0.353	3.778
TAN-21	4.122	12	5.443	0.760	5.000	0.125	TW121	5.703	5.000	0.115	19	K91521	4.192	4.222	5.610	0.250	0.353	3.982
TAN-22	4.325	12	5.724	0.791	5.281	0.125	TW122	6.000	5.281	0.130	19	K91522	4.395	4.425	6.110	0.281	0.353	4.170
TAN-24	4.716	12	6.130	0.823	5.688	0.125	TW124	6.531	5.688	0.155	19	K91524	4.801	4.831	6.735	0.375	0.353	4.551
TAN-26	5.106	12	6.755	0.885	6.188	0.125	TW126	7.047	6.188	0.155	19	K91526	5.191	5.226	7.485	0.375	0.435	4.921
TAN-128	5.497	12	7.099	1.198	6.531	0.125	TW128	7.438	6.531	0.155	19	K91528	5.582	5.617	7.485	0.375	0.590	5.312
TAN-130	5.888	12	7.693	1.260	7.063	0.125	TW130	8.063	7.063	0.193	19	K91530*	5.983	6.018	7.985	0.375	0.590	5.675
TAN-132	6.284	8	8.068	1.291	7.438	0.156	TW132	8.453	7.438	0.193	19	K91532	6.389	6.424	8.485	0.375	0.590	6.081
TAN-134	6.659	8	8.661	1.354	8.031	0.156	TW134	9.078	8.031	0.193	19	K91534*	6.764	6.799	8.985	0.375	0.715	6.456
TAN-136	7.066	8	9.06	1.416	8.375	0.156	TW136	9.438	8.375	0.193	19	K91536*	7.171	7.206	9.235	0.375	0.715	6.863
TAN-138	7.472	8	9.474	1.416	8.781	0.156	TW138	9.859	8.781	0.193	19	K91538*	7.577	7.612	9.735	0.375	0.715	7.269
TAN-140	7.847	8	9.849	1.510	9.156	0.156	TW140	10.406	9.156	0.193	19	K91540	7.982	8.017	10.110	0.375	0.840	7.674

\* custom manufactured item

# AUXILIARY PARTS – LOCKNUTS, LOCKWASHERS, AND TONGUED WASHERS

## Inch Design

### Shaft Thread and Keyway Dimensions for Standard Locknuts, Lockwashers, and Tongued Washers

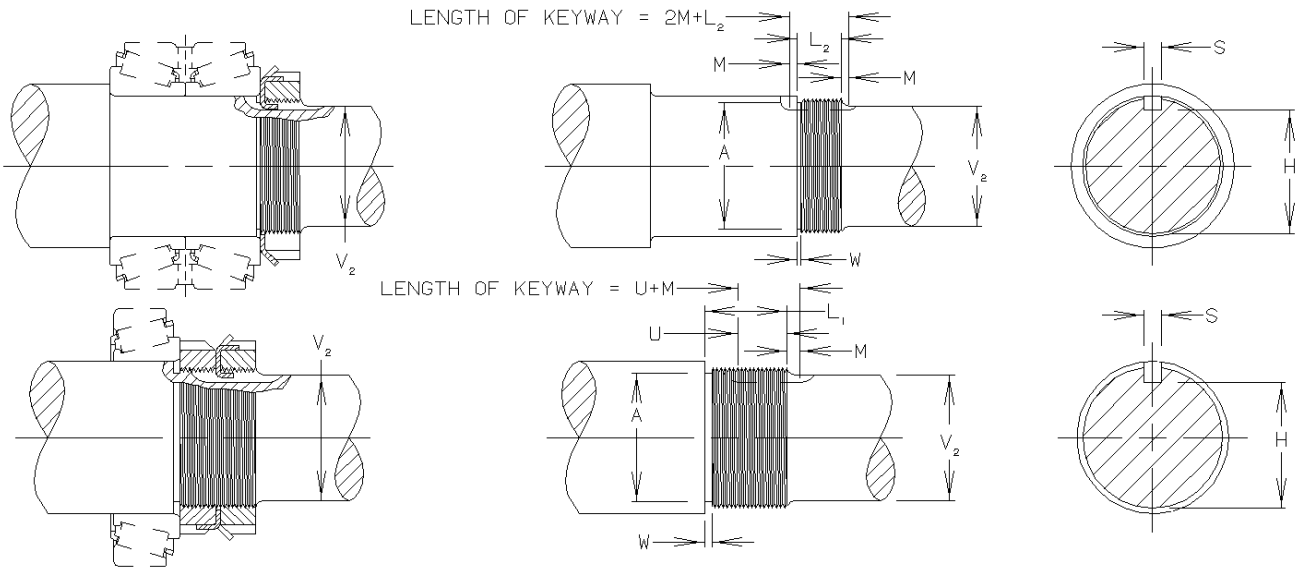

These dimensions are ABMA standards.

ABMA locknut number	number per inch	threads									shaft ext dia $V_2$	thread length		keyway			
		major diameter			pitch diameter (1)			minor diameter	relief diameter	relief width W +0.016 -0.000		L <sub>1</sub>	L <sub>2</sub>	H	S	M +0.016 -0.000	U +0.016 -0.000
		max	tol	min	max	tol	min										
N-00	32	0.391	0.0054	0.3856	0.3707	0.0026	0.3681	0.3527	0.3371 ± 0.005	0.062	0.312	0.593	0.375	0.287	0.125	0.094	0.469
N-01	32	0.469	0.0054	0.4636	0.4487	0.0026	0.4461	0.4307	0.4151 ± 0.005	0.062	0.406	0.781	0.468	0.366	0.125	0.094	0.562
N-02	32	0.586	0.0054	0.5806	0.5657	0.0030	0.5627	0.5477	0.5321 ± 0.005	0.062	0.500	0.812	0.500	0.485	0.125	0.094	0.594
N-03	32	0.664	0.0054	0.6586	0.6437	0.0030	0.6407	0.6257	0.6101 ± 0.005	0.062	0.562	0.875	0.531	0.564	0.125	0.094	0.625
N-04	32	0.781	0.0054	0.7756	0.7607	0.0034	0.7573	0.7427	0.7271 ± 0.005	0.062	0.703	0.906	0.531	0.676	0.188	0.094	0.625
N-05	32	0.969	0.0054	0.9636	0.9487	0.0034	0.9453	0.9307	0.9151 ± 0.005	0.062	0.875	1.000	0.593	0.835	0.188	0.125	0.719
N-06	18	1.173	0.0082	1.1648	1.1369	0.0040	1.1329	1.1048	1.0892 ± 0.005	0.093	1.062	1.000	0.593	1.040	0.188	0.125	0.719
TN-065	18	1.312	0.0082	1.3043	1.2764	0.0040	1.2724	1.2443	1.2287 ± 0.005	0.093	1.188	1.062	0.625	1.180	0.188	0.125	0.750
N-07	18	1.376	0.0082	1.3678	1.3399	0.0040	1.3359	1.3078	1.2922 ± 0.005	0.093	1.250	1.062	0.625	1.244	0.188	0.125	0.750
N-08	18	1.563	0.0082	1.5548	1.5269	0.0045	1.5224	1.4948	1.4792 ± 0.005	0.093	1.438	1.062	0.625	1.422	0.312	0.125	0.750
N-09	18	1.767	0.0082	1.7588	1.7309	0.0045	1.7264	1.6988	1.6832 ± 0.005	0.125	1.656	1.062	0.625	1.628	0.312	0.156	0.781
N-10	18	1.967	0.0082	1.9588	1.9309	0.0045	1.9264	1.8988	1.8832 ± 0.005	0.125	1.859	1.187	0.687	1.830	0.312	0.156	0.844
N-11	18	2.157	0.0082	2.1488	2.1209	0.0051	2.1158	1.8988	2.0732 ± 0.005	0.125	2.047	1.187	0.687	2.021	0.312	0.156	0.844
N-12	18	2.360	0.0082	2.3518	2.3239	0.0051	2.3188	2.0888	2.2762 ± 0.005	0.125	2.250	1.281	0.750	2.194	0.312	0.156	0.906
N-13	18	2.548	0.0082	2.5398	2.5119	0.0051	2.5068	2.2918	2.4642 ± 0.005	0.125	2.422	1.343	0.781	2.382	0.312	0.156	0.938
N-14	18	2.751	0.0082	2.7428	2.7149	0.0051	2.7097	2.4798	2.6672 ± 0.005	0.125	2.625	1.343	0.781	2.586	0.312	0.250	1.000
TAN-15	12	2.933	0.0112	2.9218	2.8789	0.0054	2.8735	2.6828	2.7995 ± 0.010	0.156	2.781	1.406	0.812	2.737	0.312	0.250	1.031
TAN-16	12	3.137	0.0112	3.1258	3.0829	0.0059	3.0770	2.8308	3.0035 ± 0.010	0.156	3.000	1.406	0.812	2.938	0.375	0.250	1.031
TAN-17	12	3.340	0.0112	3.3288	3.2859	0.0059	3.2800	3.0348	3.2065 ± 0.010	0.156	3.188	1.468	0.843	3.141	0.375	0.250	1.062
TAN-18	12	3.527	0.0112	3.5158	3.4729	0.0074	3.4655	3.2378	3.3935 ± 0.010	0.156	3.375	1.625	0.937	3.298	0.375	0.250	1.156
TAN-19	12	3.730	0.0112	3.7188	3.6759	0.0074	3.6685	3.4248	3.5965 ± 0.010	0.156	3.562	1.687	0.968	3.502	0.375	0.250	1.188
TAN-20	12	3.918	0.0112	3.9068	3.8639	0.0074	3.8565	3.6278	3.7845 ± 0.010	0.156	3.766	1.750	1.000	3.690	0.375	0.312	1.281
TAN-21	12	4.122	0.0112	4.1108	4.0679	0.0083	4.0596	3.8158	3.9885 ± 0.010	0.156	3.938	1.750	1.000	3.894	0.375	0.312	1.281
TAN-22	12	4.325	0.0112	4.3138	4.2709	0.0083	4.2626	4.0198	4.1915 ± 0.010	0.156	4.156	1.812	1.031	4.098	0.375	0.312	1.312
TAN-24	12	4.716	0.0112	4.7048	4.6619	0.0083	4.6536	4.6138	4.5252 ± 0.010	0.156	4.531	1.906	1.093	4.458	0.375	0.312	1.375
TAN-26	12	5.106	0.0112	5.0948	5.0519	0.0083	5.0436	5.0038	4.9725 ± 0.010	0.156	4.906	2.031	1.156	4.844	0.500	0.312	1.438
TAN-128	12	5.497	0.0112	5.4858	5.4429	0.0083	5.4346	5.3948	5.3635 ± 0.010	0.156	5.297	2.656	1.468	5.229	0.625	0.312	1.750
TAN-130	12	5.888	0.0112	5.8768	5.8339	0.0083	5.8256	5.7858	5.7545 ± 0.010	0.156	5.656	2.812	1.562	5.590	0.625	0.375	1.906
TAN-132	8	6.284	0.0152	6.2688	6.2028	0.0091	6.1937	6.1306	6.0993 ± 0.010	0.250	6.062	2.875	1.593	5.956	0.625	0.375	1.938
TAN-134	8	6.659	0.0152	6.6438	6.5778	0.0091	6.5687	6.5056	6.4743 ± 0.010	0.250	6.438	3.000	1.656	6.326	0.750	0.375	2.000
TAN-136	8	7.066	0.0152	7.0508	6.9848	0.0091	6.9757	6.9126	6.8813 ± 0.010	0.250	6.844	3.125	1.718	6.734	0.750	0.375	2.062
TAN-138	8	7.472	0.0152	7.4568	7.3908	0.0091	7.3817	7.3186	7.2873 ± 0.010	0.250	7.250	3.125	1.718	7.141	0.750	0.375	2.062
TAN-140	8	7.847	0.0152	7.8318	7.7658	0.0114	7.7544	7.6936	7.6623 ± 0.010	0.250	7.625	3.312	1.812	7.510	0.875	0.375	2.125

(1) This standard is applicable to steel nuts. When either the nut or the shaft is made of stainless steel, aluminum, or other material having a tendency to seize, it is recommended that the maximum thread diameter of the shaft, both major and pitch, be reduced by 20% of the listed pitch diameter tolerance.

14

**BEARING DIMENSIONS BY CONE BORE**

BORE d	OUTSIDE DIAMETER D	WIDTH T	CONE	CUP	BORE d	OUTSIDE DIAMETER D	WIDTH T	CONE	CUP
7.938	31.991	10.008	A2031	A2126	18.313	49.225	23.020	09072W	09194
.3125	1.2595	.3940			.7210	1.9380	.9063		
9.525	31.991	10.008	A2037	A2126	19.000	52.883	21.034	09075	09194-S
.3750	1.2595	.3940			.7480	2.0820	.8281		
11.112	31.991	11.961	A2043	A2126	19.004	56.896	19.368	1774	1729
.4375	1.2595	.4709			.7482	2.2400	.7625		
11.112	34.989	10.998	A4044	A4138	19.050	39.992	12.014	A6075	A6157
.4375	1.3775	.4330			.7500	1.5745	.4730		
11.112	38.100	17.635	00068X	00150	19.050	44.450	12.700	4A	6
.4375	1.5000	.6943			.7500	1.7500	.5000		
11.986	31.991	10.008	A2047	A2126	19.050	44.450	15.494	05075	05175
.4719	1.2595	.3940			.7500	1.7500	.6100		
12.680	34.989	10.998	A4049	A4138	19.050	45.237	15.494	LM11949	LM11910
.4992	1.3775	.4330			.7500	1.7810	.6100		
12.700	34.989	10.998	A4050	A4138	19.050	49.225	21.209	09067	09194
.5000	1.3775	.4330			.7500	1.9380	.8350		
12.700	38.100	13.495	00050	00150	19.050	52.388	23.177	1351	1328
.5000	1.5000	.5313			.7500	2.0625	.9125		
13.500	38.100	13.495	00059	00150	19.050	53.975	22.225	21075	21212
.5315	1.5000	.5313			.7500	2.1250	.8750		
14.288	44.450	20.637	1163X	1120NI	19.050	56.896	19.368	1775	1729
.5625	1.7500	.8125			.7500	2.2400	.7625		
14.989	34.989	10.998	A4059	A4138	19.588	44.450	14.236	4CX	6
.5901	1.3775	.4330			.7712	1.7500	.5605		
15.000	42.000	14.250	X30302	Y30302	19.987	44.450	15.494	05079	05175
.5906	1.6535	.5610			.7869	1.7500	.6100		
15.875	34.989	10.998	L21549	L21511	19.987	50.005	13.495	07079X	07196
.6250	1.3775	.4330			.7869	1.9687	.5313		
15.875	39.992	12.014	A6062	A6157	20.000	50.005	13.495	07079	07196
.6250	1.5745	.4730			.7874	1.9687	.5313		
15.875	40.000	14.287	03062	03157X	20.000	52.000	15.000	157	153
.6250	1.5748	.5625			.7874	2.0472	.5905		
15.875	42.862	14.287	11590	11520	20.000	42.000	15.000	X32004X	YAA32004X
.6250	1.6875	.5625			.7874	1.6535	.5906		
15.875	42.862	16.670	17580	17520	20.000	47.000	15.250	X30204M	Y30204M
.6250	1.6875	.6563			.7874	1.8504	.6004		
15.875	44.450	15.494	05062	05175	20.000	47.000	19.250	X32204	Y32204
.6250	1.7500	.6100			.7874	1.8504	.7579		
15.875	44.450	20.637	1178X	1120NI	20.000	52.000	16.250	X30304	Y30304
.6250	1.7500	.8125			.7874	2.0472	.6398		
15.875	49.225	23.020	09062	09194	20.000	52.000	22.250	X32304M	Y32304M
.6250	1.9380	.9063			.7874	2.0472	.8760		
15.875	53.975	22.225	21063	21212	20.612	50.800	20.637	09081-S	09201
.6250	2.1250	.8750			.8115	2.0000	.8125		
15.987	46.975	21.000	HM81649	HM81610	20.622	62.000	17.983	248X	242
.6294	1.8494	.8268			.8119	2.4409	.7080		
16.993	39.992	12.014	A6067	A6157	20.625	49.225	23.020	09081	09194
.6690	1.5745	.4730			.8120	1.9380	.9063		
16.993	44.450	15.494	05066	05175	20.627	56.896	19.368	1778	1729
.6690	1.7500	.6100			.8121	2.2400	.7625		
17.000	40.000	13.250	X30203	Y30203	20.638	44.450	14.236	4CB	6
.6693	1.5748	.5217			.8125	1.7500	.5605		
17.000	47.000	15.250	X30303	Y30303	20.638	45.784	26.193	1551	1530
.6693	1.8504	.6004			.8125	1.8025	1.0312		
17.000	40.000	14.287	03066X	03157X	20.638	49.225	19.845	12580	12520
.6693	1.5748	.5625			.8125	1.9380	.7813		
17.455	36.525	11.112	A5069	A5144	20.638	61.912	28.575	3660	3620
.6872	1.4380	.4375			.8125	2.4375	1.1250		
17.462	39.878	13.843	LM11749	LM11710	21.422	56.896	19.368	1784A	1729
.6875	1.5700	.5450			.8434	2.2400	.7625		
17.462	44.450	12.700	4C	6	21.430	45.237	15.494	LM12748	LM12710
.6875	1.7500	.5000			.8437	1.7810	.6100		
17.462	44.450	15.494	05068	05175	21.430	50.005	17.526	M12649	M12610
.6875	1.7500	.6100			.8437	1.9687	.6900		
17.653	49.225	19.845	09070	09195	21.986	45.237	15.494	LM12749	LM12710
.6950	1.9380	.7813			.8656	1.7810	.610		
17.988	44.450	15.494	05070XS	05175	22.225	42.070	11.176	LL52549	LL52510
.7082	1.7500	.6100			.8750	1.6563	.4400		
18.000	44.450	15.494	05070X	05175	22.225	50.005	13.495	07087	07196
.7087	1.7500	.6100			.8750	1.9687	.5313		

The Bearing Dimension Catalog is not to be used as a design manual.  
The cone bore section does not include all available parts – see series for additional information.

# BEARING DIMENSIONS BY CONE BORE

BORE d	OUTSIDE DIAMETER D	WIDTH T	CONE	CUP	BORE d	OUTSIDE DIAMETER D	WIDTH T	CONE	CUP
22.225	50.005	17.526	M12648	M12610	25.000	62.000	25.250	X32305	Y32305
.8750	1.9687	.6900			.9843	2.4409	.9941		
22.225	52.388	19.367	1380	1328	25.000	50.005	13.495	07097	07196
.8750	2.0625	.7625			.9843	1.9687	.5313		
22.225	56.896	19.368	1755	1729	25.000	62.000	16.002	17098X	17244
.8750	2.2400	.7625			.9843	2.4409	.630		
22.225	56.896	19.845	1975	1920	25.000	62.000	17.000	237	233
.8750	2.2400	.7813			.9843	2.4409	.6693		
22.225	56.896	23.812	2380	2320	25.000	62.000	17.983	247	242
.8750	2.2400	.9375			.9843	2.4409	.7080		
22.225	57.150	19.050	M53648	M53611	25.000	63.500	21.691	23098-S	23250X
.8750	2.2500	.7500			.9843	2.5000	.8540		
22.225	57.150	22.225	1280	1220	25.159	50.005	13.495	07096	07196
.8750	2.2500	.8750			.9905	1.9687	.5313		
22.225	61.912	36.513	3655	3620	25.273	50.005	13.495	07099	07196
.8750	2.4375	1.4375			.9950	1.9687	.5313		
22.225	62.000	17.983	246X	242	25.400	49.225	15.872	12CB	13C
.8750	2.4409	.7080			1.0000	1.9380	.6249		
22.225	63.100	23.812	2684	2620	25.400	50.005	13.495	07100	07196
.8750	2.4843	.9375			1.0000	1.9687	.5313		
22.225	72.626	26.988	320	312	25.400	50.292	14.224	L44642	L44610
.8750	2.8593	1.0625			1.0000	1.9800	.5600		
22.606	47.000	15.500	LM72849	LM72810	25.400	56.896	19.368	1780	1729
.8900	1.8504	.6102			1.0000	2.2400	.7625		
22.987	50.005	13.495	07090X	07196	25.400	56.896	19.845	1986	1920
.9050	1.9687	.5313			1.0000	2.2400	.7813		
23.812	49.225	15.872	12CA	13C	25.400	56.896	33.337	2356	2320
.9375	1.9380	.6249			1.0000	2.2400	1.3125		
23.812	50.005	13.495	07093	07196	25.400	57.150	17.462	15578	15520
.9375	1.9687	.5313			1.0000	2.2500	.6875		
23.812	50.292	14.224	L44640	L44610	25.400	57.150	19.431	M84548	M84510
.9375	1.9800	.5600			1.0000	2.2500	.7650		
23.812	56.896	21.826	1990X	1920	25.400	59.530	23.368	M84249	M84210
.9375	2.2400	.8593			1.0000	2.3437	.9200		
23.812	56.896	23.812	2381	2320	25.400	61.912	19.050	15100	15243
.9375	2.2400	.9375			1.0000	2.4375	.7500		
23.812	56.896	23.813	1751	1729	25.400	62.000	17.000	236	233
.9375	2.2400	.9375			1.0000	2.4409	.6693		
23.812	57.150	18.654	15574A	15520	25.400	62.000	17.983	0247	242
.9375	2.2500	.7344			1.0000	2.4409	.7080		
23.812	61.912	28.575	3659	3620	25.400	63.100	23.812	2687	2620
.9375	2.4375	1.1250			1.0000	2.4843	.9375		
23.812	62.000	17.000	235	233	25.400	63.500	21.691	23100	23250X
.9375	2.4409	.6693			1.0000	2.5000	.8540		
23.812	63.100	23.812	2683	2620	25.400	64.292	21.432	M86643	M86610
.9375	2.4843	.9375			1.0000	2.5312	.8438		
23.812	63.500	21.691	23092	23250X	25.400	66.987	20.500	02473	02419
.9375	2.5000	.8540			1.0000	2.6373	.8071		
23.812	69.723	19.050	26093	2627	25.400	68.262	22.225	M88036	M88010
.9375	2.7450	.7500			1.0000	2.6875	.8750		
23.812	72.000	39.738	3162	3120-S	25.400	68.262	22.225	2473	2420
.9375	2.8346	1.5645			1.0000	2.6875	.8750		
24.384	76.200	24.608	43096	43300	25.400	69.723	19.050	26100	26274
.9600	3.0000	.9688			1.0000	2.7450	.7500		
24.981	50.005	13.495	07098	07196	25.400	72.233	25.400	HM88630	HM88610
.9835	1.9687	.5313			1.0000	2.8438	1.0000		
24.981	62.000	16.002	17098	17244	25.400	72.626	24.607	41100	41286
.9835	2.4409	.6300			1.0000	2.8593	.9688		
25.000	85.725	21.000	V334A	3320X	25.400	72.626	26.988	315	312
.9842	3.3750	.8268			1.0000	2.8593	1.0625		
25.000	47.000	15.000	X32005X	YAA32005X	25.400	72.626	30.162	3189	3120
.9843	1.8504	.5906			1.0000	2.8593	1.1875		
25.000	52.000	16.250	X30205	YAA30205	25.400	80.167	26.987	338	3320
.9843	2.0472	.6398			1.0000	3.1562	1.0625		
25.000	52.000	19.250	X32205B	YAA32205B	25.776	72.626	26.988	321	312
.9843	2.0472	.7579			1.0148	2.8593	1.0625		
25.000	52.000	22.000	X33205	Y33205	25.987	50.292	14.224	L44645	L44610
.9843	2.0472	.8661			1.0231	1.9800	.5600		
25.000	62.000	18.250	X30305M	Y30305M	25.987	57.150	17.462	15579X	15520
.9843	2.4409	.7185			1.0231	2.2500	.6875		

15

BEARING DIMENSIONS BY CONE BORE

BORE d	OUTSIDE DIAMETER D	WIDTH T	CONE	CUP	BORE d	OUTSIDE DIAMETER D	WIDTH T	CONE	CUP
26.157	61.912	19.050	15103	15243	29.987	61.912	18.161	15115	15243
1.0298	2.4375	.7500			1.1806	2.4375	.7150		
26.162	57.150	18.654	15579A	15520	29.987	62.000	16.002	17118	17244
1.0300	2.2500	.7344			1.1806	2.4409	.6300		
26.162	61.912	19.050	15103-S	15243	29.987	66.987	20.500	02474A	02419
1.0300	2.4375	.7500			1.1806	2.6373	.8071		
23.812	63.100	23.812	2682	2620	29.987	69.012	19.050	14118AS	14272
1.0300	2.4843	.9375			1.1806	2.7170	.7500		
26.975	56.896	19.845	1987	1920	29.987	69.723	19.050	26118	26274
1.0620	2.2400	.7813			1.1806	2.7450	.7500		
26.988	50.292	14.224	L44649	L44610	29.987	76.200	24.608	43117	43300
1.0625	1.9800	.5600			1.1806	3.0000	.9688		
26.988	56.896	19.845	1997X	1920	30.000	61.912	19.050	15117X	15243
1.0625	2.2400	.7813			1.1811	2.4375	.7500		
26.988	57.150	17.462	15580	15520	30.000	62.000	16.002	17118-S	17244
1.0625	2.2500	.6875			1.1811	2.4409	.6300		
26.988	57.150	19.431	M84549	M84510	30.000	66.421	25.400	2560X	2520
1.0625	2.2500	.7650			1.1811	2.6150	1.0000		
26.988	61.912	19.050	15106	15243	30.000	69.012	19.050	14117A	14272
1.0625	2.4375	.7500			1.1811	2.7170	.7500		
26.988	63.100	23.812	2688	2620	30.000	69.723	19.050	26118-S	26274
1.0625	2.4843	.9375			1.1811	2.7450	.7500		
26.988	72.000	17.000	258	25	30.000	72.626	26.988	319	312
1.0625	2.8346	.6693			1.1811	2.8593	1.0625		
26.988	72.626	24.607	41106	41286	30.000	72.626	30.162	3190	3120
1.0625	2.8593	.9688			1.1811	2.8593	1.1875		
27.200	63.100	23.812	2681	2620	30.000	82.550	34.925	416	412
1.0709	2.4843	.9375			1.1811	3.2500	1.3750		
27.988	66.987	20.500	02473X	02419	30.000	62.000	17.000	X32006X	YGA32006X
1.1019	2.6373	.8071			1.1811	2.4409	.6693		
28.575	56.896	19.845	1984W	1920	30.000	62.000	17.250	X30206M	Y30206M
1.1250	2.2400	.7813			1.1811	2.4409	.6791		
28.575	57.150	17.462	15590	15520	30.000	62.000	21.250	X32206B	Y32206B
1.1250	2.2500	.6875			1.1811	2.4409	.8366		
28.575	59.131	15.875	LM67043	LM67010	30.000	62.000	25.000	X33206	Y33206
1.1250	2.3280	.6250			1.1811	2.4409	.9843		
28.575	61.912	19.050	15112	15243	30.000	72.000	20.750	X30306M	Y30306M
1.1250	2.4375	.7500			1.1811	2.8346	.8169		
28.575	63.100	23.812	2689	2620	30.000	72.000	28.750	X32306	Y32306
1.1250	2.4843	.9375			1.1811	2.8346	1.1319		
28.575	64.292	21.432	M86647	M86610	30.112	61.912	19.050	15116	15243
1.1250	2.5312	.8438			1.1855	2.4375	.7500		
28.575	66.421	19.052	24112	24261	30.124	64.287	18.273	40	36X
1.1250	2.6150	.7501			1.1860	2.5310	.7194		
28.575	66.421	25.400	2578	2520	30.162	58.738	14.683	08118	08231
1.1250	2.6150	1.0000			1.1875	2.3125	.5781		
28.575	66.987	20.500	02474	02419	30.162	61.087	19.050	29	32
1.1250	2.6373	.8071			1.1875	2.4050	.7500		
28.575	68.262	22.225	M88040	M88010	30.162	62.000	16.002	17119	17244
1.1250	2.6875	.8750			1.1875	2.4409	.6300		
28.575	68.262	22.225	2474	2420	30.162	64.292	21.432	M86649	M86610
1.1250	2.6875	.8750			1.1875	2.5312	.8438		
28.575	69.723	19.050	26112	26274	30.162	66.421	19.052	24118	24261
1.1250	2.7450	.7500			1.1875	2.6150	.7501		
28.575	72.626	24.607	41125	41286	30.162	66.421	25.400	2558	2520
1.1250	2.8593	.9688			1.1875	2.6150	1.0000		
28.575	72.626	30.162	3192	3120	30.162	68.262	22.225	M88043	M88010
1.1250	2.8593	1.1875			1.1875	2.6875	.8750		
28.575	73.025	22.225	02872	02820	30.162	72.000	17.000	257	253
1.1250	2.8750	.8750			1.1875	2.8346	.6693		
28.575	82.550	25.400	43112	43326	30.162	72.626	26.988	316	312
1.1250	3.2500	1.0000			1.1875	2.8593	1.0625		
28.575	90.000	30.958	445	429XS	30.162	72.626	30.162	3187	3120
1.1250	3.5433	1.2188			1.1875	2.8593	1.1875		
29.000	50.292	14.224	L45449	L45410	30.162	76.200	20.637	28118	28300
1.1417	1.9800	.5600			1.1875	3.0000	.8125		
29.367	63.100	23.812	2690	2620	30.162	79.375	29.370	3474	3420
1.1562	2.4843	.9375			1.1875	3.1250	1.1563		
29.972	72.626	26.988	322	312	30.162	82.550	25.400	43118	43326
1.1800	2.8593	1.0625			1.1875	3.2500	1.0000		

The Bearing Dimension Catalog is not to be used as a design manual.  
The cone bore section does not include all available parts – see series for additional information.

# BEARING DIMENSIONS BY CONE BORE

BORE d	OUTSIDE DIAMETER D	WIDTH T	CONE	CUP	BORE d	OUTSIDE DIAMETER D	WIDTH T	CONE	CUP
30.162	85.725	21.000	334	3320X	32.000	69.723	19.050	26126X	26274
1.1875	3.3750	.8268			1.2598	2.7450	.7500		
30.162	90.119	23.000	356	352	32.004	69.723	19.050	26126	26274
1.1875	3.5480	.9055			1.2600	2.7450	.7500		
30.175	61.912	19.050	15120A	15243	32.532	66.421	26.988	2584	2520
1.1880	2.4375	.7500			1.2808	2.6150	1.0625		
30.213	61.912	19.050	15118	15243	33.338	66.421	30.955	2554	2520
1.1895	2.4375	.7500			1.3125	2.6150	1.2187		
30.213	66.421	25.400	2561X	2520	33.338	66.675	20.638	1680	1620
1.1895	2.6150	1.0000			1.3125	2.6250	.8125		
30.226	69.012	19.050	14116	14272	33.338	66.675	20.638	M38545	M38510
1.1900	2.7170	.7500			1.3125	2.6250	.8125		
30.955	64.292	21.432	M86648	M86610	33.338	68.262	22.225	M88047	M88010
1.2187	2.5312	.8438			1.3125	2.6875	.8750		
30.955	68.262	22.225	M88045	M88010	33.338	68.262	22.225	16582	16522
1.2187	2.6875	.8750			1.3125	2.6875	.8750		
31.623	66.675	20.638	1674	1620	33.338	69.012	19.050	14130	14272
1.2450	2.6250	.8125			1.3125	2.7170	.7500		
31.750	58.738	14.683	08125	08231	33.338	69.723	19.050	26131	26274
1.2500	2.3125	.5781			1.3125	2.7450	.7500		
31.750	59.131	15.875	LM67045	LM67010	33.338	72.000	17.000	256	253
1.2500	2.3280	.6250			1.3125	2.8346	.6693		
31.750	61.912	19.050	15125	15243	33.338	72.000	19.000	16131	16282
1.2500	2.4375	.7500			1.3125	2.8346	.7480		
31.750	66.421	30.955	2553	2520	33.338	72.626	30.162	3196	3120
1.2500	2.6150	1.2187			1.3125	2.8593	1.1875		
31.750	66.987	20.500	02475	02419	33.338	73.025	22.225	2876	2820
1.2500	2.6373	.8071			1.3125	2.8750	.8750		
31.750	68.262	22.225	M88046	M88010	33.338	73.025	29.370	HM88547	HM88510
1.2500	2.6875	.8750			1.3125	2.8750	1.1563		
31.750	68.262	22.225	16579	16522	33.338	76.200	23.775	2785	2720
1.2500	2.6875	.8750			1.3125	3.0000	.9360		
31.750	68.262	22.225	2475	2420	33.338	76.200	24.608	43131	43300
1.2500	2.6875	.8750			1.3125	3.0000	.9688		
31.750	68.262	26.987	23491	23420	33.338	76.200	29.369	HM89443	HM89410
1.2500	2.6875	1.0625			1.3125	3.0000	1.1563		
31.750	69.012	26.187	14123A	14272	33.338	76.200	29.370	31590	31520
1.2500	2.7170	1.0310			1.3125	3.0000	1.1563		
31.750	72.000	17.000	255	253	33.338	79.375	29.370	3477	3420
1.2500	2.8346	.6693			1.3125	3.1250	1.1563		
31.750	72.233	25.400	HM88644	HM88610	33.338	80.167	26.987	335-S	3320
1.2500	2.8438	1.0000			1.3125	3.1562	1.0625		
31.750	72.626	30.162	3188	3120	33.338	88.500	25.400	44131	44348
1.2500	2.8593	1.1875			1.3125	3.4843	1.0000		
31.750	73.025	22.225	2875	2820	34.925	65.088	18.034	LM48548A	LM48510
1.2500	2.8750	.8750			1.3750	2.5625	.7100		
31.750	73.025	22.225	02875	02820	34.925	66.675	20.638	M38549	M38510
1.2500	2.8750	.8750			1.3750	2.6250	.8125		
31.750	73.025	26.988	23685	23620	34.925	68.262	20.638	14585	14525
1.2500	2.8750	1.0625			1.3750	2.6875	.8125		
31.750	73.025	29.370	HM88542	HM88510	34.925	69.012	26.187	14136A	14272
1.2500	2.8750	1.1563			1.3750	2.7170	1.0310		
31.750	76.200	23.775	2783	2720	34.925	72.000	19.000	16137	16282
1.2500	3.0000	.9360			1.3750	2.8346	.7480		
31.750	76.200	29.369	HM89440	HM89410	34.925	72.233	25.400	HM88649	HM88610
1.2500	3.0000	1.1563			1.3750	2.8438	1.0000		
31.750	79.375	29.370	3476	3420	34.925	72.626	26.988	325	312
1.2500	3.1250	1.1563			1.3750	2.8593	1.0625		
31.750	80.167	26.987	346	3320	34.925	73.025	22.225	2877	2820
1.2500	3.1562	1.0625			1.3750	2.8750	.8750		
31.750	82.550	25.400	43125	43326	34.925	73.025	22.225	02877	02820
1.2500	3.2500	1.0000			1.3750	2.8750	.8750		
31.750	88.500	25.400	44126	44348	34.925	73.025	23.813	25877	25820
1.2500	3.4843	1.0000			1.3750	2.8750	.9375		
31.750	90.000	30.958	443	429XS	34.925	73.025	26.988	23690	23620
1.2500	3.5433	1.2188			1.3750	2.8750	1.0625		
31.986	66.987	20.500	02476X	02419	34.925	73.025	26.988	23790	23720
1.2593	2.6373	.8071			1.3750	2.8750	1.0625		
31.986	72.233	25.400	HM88638	HM88610	34.925	76.200	20.637	28137	28300
1.2593	2.8438	1.0000			1.3750	3.0000	.8125		

15



## BEARING DIMENSIONS BY CONE BORE

BORE d	OUTSIDE DIAMETER D	WIDTH T	CONE	CUP	BORE d	OUTSIDE DIAMETER D	WIDTH T	CONE	CUP
34.925	76.200	23.775	2786	2720	35.000	80.167	25.400	26883	26820
1.3750	3.0000	.9360			1.3780	3.1562	1.0000		
34.925	76.200	29.369	HM89446	HM89410	35.000	80.167	26.987	339	3320
1.3750	3.0000	1.1563			1.3780	3.1562	1.0625		
34.925	76.200	29.370	36137	36300	35.000	82.550	24.608	43138X	43326
1.3750	3.0000	1.1563			1.3780	3.2500	.9688		
34.925	76.200	29.370	31593	31520	35.000	82.550	34.925	421	412
1.3750	3.0000	1.1563			1.3780	3.2500	1.3750		
34.925	79.375	29.370	3478	3420	35.000	90.000	30.958	441	429XS
1.3750	3.1250	1.1563			1.3780	3.5433	1.2188		
34.925	80.035	23.812	27875	27821	35.128	65.088	18.034	LM48545	LM48510
1.3750	3.1510	.9375			1.3830	2.5625	.7100		
34.925	80.167	26.987	335	3320	35.306	73.025	22.225	2880	2820
1.3750	3.1562	1.0625			1.3900	2.8750	.8750		
34.925	80.167	37.307	3360	3320	35.707	76.200	23.775	2791A	2720
1.3750	3.1562	1.4688			1.4058	3.0000	.9360		
34.925	82.550	25.400	43137X	43326	35.710	80.167	37.126	347X	3320
1.3750	3.2500	1.0000			1.4059	3.1562	1.4617		
34.925	82.550	34.925	417	412	35.717	72.233	25.400	HM88648	HM88610
1.3750	3.2500	1.3750			1.4062	2.8438	1.0000		
34.925	84.138	30.162	3581	3520	36.449	73.025	22.225	02884	02820
1.3750	3.3125	1.1875			1.4350	2.8750	.8750		
34.925	85.725	30.163	3872	3820	36.487	73.025	23.813	25880	25820
1.3750	3.3750	1.1875			1.4365	2.8750	.9375		
34.925	88.500	39.687	4368	4320	36.487	76.200	23.775	2780	2720
1.3750	3.4843	1.5625			1.4365	3.0000	.9360		
34.925	90.000	30.958	449	429XS	36.487	80.167	29.370	3378	3320
1.3750	3.5433	1.2188			1.4365	3.1562	1.1563		
34.925	100.040	36.449	3751	3735	36.512	66.675	15.875	19143	19262
1.3750	3.9386	1.4350			1.4375	2.6250	.6250		
34.976	66.675	15.875	19138	19262	36.512	69.012	19.050	13682	13620
1.3770	2.6250	.6250			1.4375	2.7170	.7500		
34.976	69.012	19.050	14139	14272	36.512	72.000	19.000	16143	16282
1.3770	2.7170	.7500			1.4375	2.8346	.7480		
34.976	76.200	20.637	28138	28300	36.512	76.200	29.369	HM89448	HM89410
1.3770	3.0000	.8125			1.4375	3.0000	1.1563		
34.976	76.200	23.775	2775	2720	36.512	76.200	29.370	31597	31520
1.3770	3.0000	.9360			1.4375	3.0000	1.1563		
34.988	59.131	15.875	L68149A	L68110	36.512	79.375	29.370	3479	3420
1.3775	2.3280	.6250			1.4375	3.1250	1.1563		
34.988	61.973	16.702	LM78349A	LM78310A	36.512	79.375	29.370	HM89249	HM89210
1.3775	2.4399	.6576			1.4375	3.1250	1.1563		
34.988	66.675	20.638	M38547	M38510	36.512	80.167	25.400	26877	26820
1.3775	2.6250	.8125			1.4375	3.1562	1.0000		
35.000	62.000	18.000	X32007X	Y32007X	36.512	80.167	37.307	3353	3320
1.3780	2.4409	.7087			1.4375	3.1562	1.4688		
35.000	72.000	18.250	X30207M	Y30207M	36.512	81.973	23.876	25570	25518
1.3780	2.8346	.7185			1.4375	3.2273	.9400		
35.000	72.000	24.250	X32207M	Y32207M	36.512	85.725	30.163	3878	3820
1.3780	2.8346	.9547			1.4375	3.3750	1.1875		
35.000	72.000	28.000	X33207	Y33207	36.512	88.500	25.400	44143	44348
1.3780	2.8346	1.1024			1.4375	3.4843	1.0000		
35.000	80.000	22.750	X31307	Y31307	36.512	90.043	50.800	4356	4328
1.3780	3.1496	.8957			1.4375	3.5450	2.0000		
35.000	80.000	22.750	X30307M	Y30307M	36.512	93.662	31.750	46143	46368
1.3780	3.1496	.8957			1.4375	3.6875	1.2500		
35.000	80.000	32.750	X32307	Y32307	38.000	66.675	15.875	19149X	19262
1.3780	3.1496	1.2894			1.4961	2.6250	.6250		
35.000	66.675	15.875	19138X	19262	38.100	63.500	12.700	13889	13830
1.3780	2.6250	.6250			1.5000	2.5000	.5000		
35.000	69.012	19.050	14139X	14272	38.100	65.088	18.034	LM29749	LM29710
1.3780	2.7170	.7500			1.5000	2.5625	.7100		
35.000	72.000	17.000	259	253	38.100	66.675	15.875	19150	19262
1.3780	2.8346	.6693			1.5000	2.6250	.6250		
35.000	73.025	26.988	23691	2362	38.100	69.012	19.050	13685	13620
1.3780	2.8750	1.0625			1.5000	2.7170	.7500		
35.000	76.200	20.637	28138X	28300	38.100	72.000	19.000	16150	16282
1.3780	3.0000	.8125			1.5000	2.8346	.7480		
35.000	79.375	29.370	3480	3420	38.100	76.200	20.637	28150	28300
1.3780	3.1250	1.1563			1.5000	3.0000	.8125		

15

The Bearing Dimension Catalog is not to be used as a design manual.  
The cone bore section does not include all available parts – see series for additional information.

## BEARING DIMENSIONS BY CONE BORE

BORE d	OUTSIDE DIAMETER D	WIDTH T	CONE	CUP	BORE d	OUTSIDE DIAMETER D	WIDTH T	CONE	CUP
38.100	76.200	23.775	2776	2720	39.668	107.950	32.557	457	452
1.5000	3.0000	.9360			1.5625	4.2500	1.2818		
38.100	79.375	29.370	3490	3420	39.688	120.650	41.275	620	612
1.5000	3.1250	1.1563			1.5625	4.7500	1.6250		
38.100	80.035	22.225	27879	27821	39.980	76.200	18.009	11157	113000
1.5000	3.1510	.8750			1.5740	3.0000	.7090		
38.100	80.167	25.400	26878	26820	39.980	76.200	19.347	28155	28300
1.5000	3.1562	1.0000			1.5740	3.0000	.7617		
38.100	80.167	26.987	337	3320	39.987	90.975	32.000	HM204043	HM204010
1.5000	3.1562	1.0625			1.5743	3.5817	1.2598		
38.100	80.167	37.307	3362	3320	40.000	76.200	18.009	11157X	11300
1.5000	3.1562	1.4688			1.5748	3.0000	.7090		
38.100	81.973	23.876	25572	25518	40.000	76.200	20.637	28158	28300
1.5000	3.2273	.9400			1.5748	3.0000	.8125		
38.100	82.550	29.370	HM801346	HM801310	40.000	80.167	26.987	344	3320
1.5000	3.2500	1.1563			1.5748	3.1562	1.0625		
38.100	82.550	34.925	415	412	40.000	82.550	34.925	420	412
1.5000	3.2500	1.3750			1.5748	3.2500	1.3750		
38.100	84.138	30.162	3580	3520	40.000	84.138	30.162	3582	3520
1.5000	3.3125	1.1875			1.5748	3.3125	1.1875		
38.100	85.725	30.163	3875	3820	40.000	85.725	30.163	3879	3820
1.5000	3.3750	1.1875			1.5748	3.3750	1.1875		
38.100	88.500	25.400	44150	44348	40.000	88.500	25.400	44157	44348
1.5000	3.4843	1.0000			1.5748	3.4843	1.0000		
38.100	88.500	39.687	4375	4320	40.000	90.000	30.958	442-S	429XS
1.5000	3.4843	1.5625			1.5748	3.5433	1.2188		
38.100	90.000	30.958	440	429XS	40.000	90.119	23.000	350	352
1.5000	3.5433	1.2188			1.5748	3.5480	.9055		
38.100	93.662	31.750	49150	49368	40.000	107.950	32.557	459	452
1.5000	3.6875	1.2500			1.5748	4.2500	1.2818		
38.100	93.662	31.750	46150	46368	40.000	111.125	38.100	543	532
1.5000	3.6875	1.2500			1.5748	4.3750	1.5000		
38.100	95.250	27.783	33880	33821	40.000	68.000	19.000	X32008X	Y32008XZ
1.5000	3.7500	1.0938			1.5748	2.6772	.7480		
38.100	95.250	30.956	53150	53375	40.000	75.000	26.000	X33108	Y33108
1.5000	3.7500	1.2188			1.5748	2.9528	1.0236		
38.100	95.250	30.958	HM903241	HM903210	40.000	80.000	19.750	X30208M	Y30208M
1.5000	3.7500	1.2188			1.5748	3.1496	.7776		
38.100	100.000	34.925	525	520X	40.000	80.000	24.750	X32208M	Y32208M
1.5000	3.9370	1.3750			1.5748	3.1496	.9744		
38.100	107.950	32.557	455A	452	40.000	80.000	32.000	X33208	Y33208
1.5000	4.2500	1.2818			1.5748	3.1496	1.2598		
38.100	111.125	38.100	542	532	40.000	90.000	25.250	X31308	Y31308
1.5000	4.3750	1.5000			1.5748	3.5433	.9941		
38.481	63.500	12.700	13890	13830	40.000	90.000	35.250	X32308B	Y32308B
1.5150	2.5000	.5000			1.5748	3.5433	1.3878		
38.496	66.675	15.875	19153X	19262	40.483	80.167	28.257	337X	3320
1.5156	2.6250	.6250			1.5938	3.1562	1.1125		
39.688	73.025	16.667	18587	18520	40.483	82.550	29.370	HM801349	HM801310
1.5625	2.8750	.6562			1.5938	3.2500	1.1563		
39.688	73.025	25.654	M201047	M201011	41.275	67.975	17.500	LM300848	LM300811
1.5625	2.8750	1.0100			1.6250	2.6762	.6890		
39.688	76.200	23.775	2789	2720	41.275	73.025	16.667	18590	18520
1.5625	3.0000	.9360			1.6250	2.8750	.6562		
39.688	79.375	31.354	17883	17830	41.275	73.431	19.558	LM501349	LM501310
1.5625	3.1250	1.2344			1.6250	2.8910	.7700		
39.688	80.167	25.400	26880	26820	41.275	76.200	18.009	11162	11300
1.5625	3.1562	1.0000			1.6250	3.0000	.7090		
39.688	80.167	29.370	3382	3320	41.275	76.200	22.225	24780	24720
1.5625	3.1562	1.1563			1.6250	3.0000	.8750		
39.688	82.550	34.925	422	412	41.275	80.167	25.400	26882	26820
1.5625	3.2500	1.3750			1.6250	3.1562	1.0000		
39.688	88.500	25.400	44156	44348	41.275	80.167	26.987	336	3320
1.5625	3.4843	1.0000			1.6250	3.1562	1.0625		
39.688	88.500	39.687	4367	4320	41.275	80.167	29.370	3383	3320
1.5625	3.4843	1.5625			1.6250	3.1562	1.1563		
39.688	100.000	28.173	3774	373	41.275	82.550	26.195	22778	22720
1.5625	3.9370	1.1092			1.6250	3.2500	1.0313		
39.688	100.000	34.925	525A	520X	41.275	82.550	26.543	M802047	M802011
39.688	107.950	32.557			1.6250	3.2500	1.0450		

15

**BEARING DIMENSIONS BY CONE BORE**

BORE d	OUTSIDE DIAMETER D	WIDTH T	CONE	CUP	BORE d	OUTSIDE DIAMETER D	WIDTH T	CONE	CUP
41.275	82.550	34.925	419	412	42.987	74.988	19.367	16986	16929
1.6250	3.2500	1.3750			1.6924	2.9523	.7625		
41.275	84.138	30.162	3576	3520	42.987	79.375	20.638	17886	17830
1.6250	3.3125	1.1875			1.6924	3.1250	.8125		
41.275	85.725	30.163	3877	3820	43.000	80.167	26.987	342X	3320
1.6250	3.3750	1.1875			1.6929	3.1562	1.0625		
41.275	88.500	25.400	44162	44348	44.450	71.438	12.700	LL103049	LL103010
1.6250	3.4843	1.0000			1.7500	2.8125	.5000		
41.275	88.500	39.687	4388	4320	44.450	73.025	18.258	L102849	L102810
1.6250	3.4843	1.5625			1.7500	2.8750	.7188		
41.275	88.900	30.162	HM803145	HM803110	44.450	76.992	17.464	12175	12303
1.6250	3.5000	1.1875			1.7500	3.0312	.6876		
41.275	90.000	20.000	365A	362	44.450	79.375	17.462	18685	18620
1.6250	3.5433	.7874			1.7500	3.1250	.6875		
41.275	90.000	30.958	439	429XS	44.450	79.375	31.354	17884	17830
1.6250	3.5433	1.2188			1.7500	3.1250	1.2344		
41.275	92.075	26.195	M903345	M903310	44.450	80.962	19.050	13175	13318
1.6250	3.6250	1.0313			1.7500	3.1875	.7500		
41.275	93.662	31.750	49162	49368	44.450	81.973	23.876	25580	25518
1.6250	3.6875	1.2500			1.7500	3.2273	.9400		
41.275	93.662	31.750	46162	46368	44.450	82.931	22.225	35175	35326
1.6250	3.6875	1.2500			1.7500	3.2650	.8750		
41.275	95.250	30.163	HM804840	HM804810	44.450	84.138	30.162	3578	3520
1.6250	3.7500	1.1875			1.7500	3.3125	1.1875		
41.275	95.250	30.956	53162	53375	44.450	85.000	25.400	2975	2924
1.6250	3.7500	1.2188			1.7500	3.3465	1.0000		
41.275	95.250	30.958	HM903244	HM903210	44.450	88.500	46.037	4364	4320
1.6250	3.7500	1.2188			1.7500	3.4843	1.8125		
41.275	100.000	34.925	526	520X	44.450	88.900	30.162	HM803149	HM803110
1.6250	3.9370	1.3750			1.7500	3.5000	1.1875		
41.275	100.040	36.449	3753	3735	44.450	90.000	30.958	435	429XS
1.6250	3.9386	1.4350			1.7500	3.5433	1.2188		
41.275	104.775	36.512	59162	59412	44.450	90.119	23.000	355	352
1.6250	4.1250	1.4375			1.7500	3.5480	.9055		
41.275	104.775	36.512	HM807035	HM807010	44.450	93.662	31.750	49175	49368
1.6250	4.1250	1.4375			1.7500	3.6875	1.2500		
41.275	107.950	32.557	464	452	44.450	93.662	31.750	46175	46368
1.6250	4.2500	1.2818			1.7500	3.6875	1.2500		
41.275	111.125	38.100	541	532	44.450	95.250	27.783	33885	33821
1.6250	4.3750	1.5000			1.7500	3.7500	1.0938		
42.000	76.200	18.009	11165X	11300	44.450	95.250	30.163	HM804842	HM804810
1.6535	3.0000	.7090			1.7500	3.7500	1.1875		
42.070	88.500	39.687	4395	4320	44.450	95.250	30.958	HM903247	HM903210
1.6563	3.4843	1.5625			1.7500	3.7500	1.2188		
42.850	107.950	32.557	461	452	44.450	98.425	21.000	386AS	382
1.6870	4.2500	1.2818			1.7500	3.8750	.8268		
42.862	76.992	17.464	12168	12303	44.450	100.000	34.523	3760	373
1.6875	3.0312	.6876			1.7500	3.9370	1.3592		
42.862	81.973	23.876	25576	25518	44.450	100.000	34.925	527	520X
1.6875	3.2273	.9400			1.7500	3.9370	1.3750		
42.862	82.550	19.842	22168	22325	44.450	101.200	43.657	5356	5320
1.6875	3.2500	.7812			1.7500	3.9843	1.7188		
42.862	82.550	26.195	22780	22720	44.450	101.600	31.750	49576	49520
1.6875	3.2500	1.0313			1.7500	4.0000	1.2500		
42.862	84.138	30.162	3579	3520	44.450	104.775	30.162	45280	45220
1.6875	3.3125	1.1875			1.7500	4.1250	1.1875		
42.862	84.988	19.000	29168	29334	44.450	104.775	36.512	59175	59412
1.6875	3.3460	.7480			1.7500	4.1250	1.4375		
42.862	85.000	25.400	2973	2924	44.450	104.775	36.512	HM807040	HM807010
1.6875	3.3465	1.0000			1.7500	4.1250	1.4375		
42.862	114.300	44.450	65383	65320	44.450	107.950	32.557	458	452
1.6875	4.5000	1.7500			1.7500	4.2500	1.2818		
42.875	80.167	25.400	26884	26820	44.450	109.985	29.251	55175	55434
1.6880	3.1562	1.0000			1.7500	4.3301	1.1516		
42.875	80.167	26.987	342-S	3320	44.450	109.985	29.251	55175C	55434
1.6880	3.1562	1.0625			1.7500	4.3301	1.1516		
42.875	81.973	23.876	25577	25518	44.450	111.125	30.163	HM907635	HM907614
1.6880	3.2273	.9400			1.7500	4.3750	1.1875		
42.987	67.975	17.502	LM300849C	LM300811	44.450	111.125	38.100	535	532
1.6924	2.6762	.6891			1.7500	4.3750	1.5000		

The Bearing Dimension Catalog is not to be used as a design manual.  
The cone bore section does not include all available parts – see series for additional information.



**BEARING DIMENSIONS BY CONE BORE**

BORE d	OUTSIDE DIAMETER D	WIDTH T	CONE	CUP	BORE d	OUTSIDE DIAMETER D	WIDTH T	CONE	CUP
44.450	114.300	44.450	65384	65320	46.038	79.375	17.462	18690	18620
1.7500	4.5000	1.7500			1.8125	3.1250	.6875		
44.450	120.650	41.275	615	612	46.038	80.962	19.050	13181	13318
1.7500	4.7500	1.6250			1.8125	3.1875	.7500		
44.450	127.000	50.800	6277	6220	46.038	81.973	23.876	25592	25518
1.7500	5.0000	2.0000			1.8125	3.2273	.9400		
44.869	89.980	24.750	28576	28520	46.038	85.000	17.462	18780	18720
1.7665	3.5425	.9744			1.8125	3.3465	.6875		
44.945	90.000	30.958	450	429XS	46.038	85.000	25.400	2984	2924
1.7695	3.5433	1.2188			1.8125	3.3465	1.0000		
44.983	81.973	23.876	25584	25518	46.038	90.000	30.958	436	429XS
1.7710	3.2273	.9400			1.8125	3.5433	1.2188		
44.983	84.988	19.000	29177	29334	46.038	90.119	23.000	359A	352
1.7710	3.3460	.7480			1.8125	3.5480	.9055		
44.983	100.000	28.173	3776	373	46.038	100.000	28.173	3777	373
1.7710	3.9370	1.1092			1.8125	3.9370	1.1092		
44.983	100.000	34.925	527-S	520X	47.500	100.000	27.250	XFA30309M	Y30309M
1.7710	3.9370	1.3750			1.8701	3.9370	1.0728		
44.988	81.973	23.876	25584A	25518	47.625	88.900	25.400	M804048	M804010
1.7712	3.2273	.9400			1.8750	3.5000	1.0000		
44.988	90.000	20.000	367X	362	47.625	90.000	20.000	369A	362
1.7712	3.5433	.7874			1.8750	3.5433	.7874		
44.988	95.250	30.958	HM903248	HM903210	47.625	95.250	30.163	HM804846	HM804810
1.7712	3.7500	1.2188			1.8750	3.7500	1.1875		
44.988	104.986	32.512	HM905843	HM905810	47.625	98.425	21.000	386A	382
1.7712	4.1333	1.2800			1.8750	3.8750	.8268		
44.988	110.000	27.000	396A	393	47.625	100.000	28.173	3778	373
1.7712	4.3307	1.0630			1.8750	3.9370	1.1092		
44.991	100.000	38.545	V527A	520X	47.625	100.000	34.925	528	520X
1.7713	3.9370	1.5175			1.8750	3.9370	1.3750		
45.000	85.000	20.750	X30209M	Y30209M	47.625	101.200	43.657	5358	5320
1.7717	3.3465	.8169			1.8750	3.9843	1.7188		
45.000	85.000	24.750	X32209M	Y32209M	47.625	101.600	31.750	49580	49520
1.7717	3.3465	.9744			1.8750	4.0000	1.2500		
45.000	85.000	32.000	X33209	Y33209	47.625	104.775	30.162	45282	45220
1.7717	3.3465	1.2598			1.8750	4.1250	1.1875		
45.000	100.000	27.250	X31309M	Y31309M	47.625	104.775	36.512	59187	59412
1.7717	3.9370	1.0728			1.8750	4.1250	1.4375		
45.000	100.000	38.250	X32309BM	Y32309BM	47.625	107.950	32.557	463	452
1.7717	3.9370	1.5059			1.8750	4.2500	1.2818		
45.000	90.000	20.000	367	362	47.625	109.985	29.251	55187	55434
1.7717	3.5433	.7874			1.8750	4.3301	1.1516		
45.000	90.000	30.958	435-S	429XS	47.625	109.985	29.251	55187C	55434
1.7717	3.5433	1.2188			1.8750	4.3301	1.1516		
45.000	90.119	23.000	358	352	47.625	111.125	30.163	HM907639	HM907614
1.7717	3.5480	.9055			1.8750	4.3750	1.1875		
45.000	100.000	25.000	376	372	47.625	111.125	38.100	536	532
1.7717	3.9370	.9842			1.8750	4.3750	1.5000		
45.000	101.200	39.687	4559	4520	47.625	117.475	33.338	66187	66461
1.7717	3.9843	1.5625			1.8750	4.6250	1.3125		
45.000	107.950	32.557	458-S	452	47.625	120.650	41.275	617	612
1.7717	4.2500	1.2818			1.8750	4.7500	1.6250		
45.230	79.375	20.638	17887	17830	47.625	123.825	36.512	72187C	72487
1.7807	3.1250	.8125			1.8750	4.8750	1.4375		
45.237	84.138	30.162	3586	3520	47.625	123.825	36.512	72187	72487
1.7810	3.3125	1.1875			1.8750	4.8750	1.4375		
45.242	73.431	19.558	LM102949	LM102910	48.412	95.250	30.163	HM804848	HM804810
1.7812	2.8910	.7700			1.9060	3.7500	1.1875		
45.242	77.788	19.842	LM603049	LM603011	48.412	100.000	28.173	3781A	373
1.7812	3.0625	.7812			1.9060	3.9370	1.1092		
45.618	81.973	23.876	25590	25518	49.212	90.000	20.000	365-S	362
1.7960	3.2273	.9400			1.9375	3.5433	.7874		
45.771	90.000	30.958	437	429XS	49.212	100.000	28.173	3781	373
1.8020	3.5433	1.2188			1.9375	3.9370	1.1092		
45.987	74.976	18.000	LM503349	LM503310	49.212	101.200	43.657	5395	5320
1.8105	2.9518	.7087			1.9375	3.9843	1.7188		
45.987	90.975	32.000	HM204049	HM204010	49.212	104.775	36.512	HM807044	HM807010
1.8105	3.5817	1.2598			1.9375	4.1250	1.4375		
46.038	77.788	12.700	LL205442	LL205410	49.212	111.125	38.100	545	532
1.8125	3.0625	.5000			1.9375	4.3750	1.5000		

15

## BEARING DIMENSIONS BY CONE BORE

BORE d	OUTSIDE DIAMETER D	WIDTH T	CONE	CUP	BORE d	OUTSIDE DIAMETER D	WIDTH T	CONE	CUP
49.212	114.300	44.450	HH506348	HH506310	50.800	101.600	31.750	49585	49520
1.9375	4.5000	1.7500			2.0000	4.0000	1.2500		
49.212	114.300	44.450	65390	65320	50.800	104.775	30.162	45284	45220
1.9375	4.5000	1.7500			2.0000	4.1250	1.1875		
49.212	120.251	44.450	5562	5520	50.800	104.775	36.512	59200	59412
1.9375	4.7343	1.7500			2.0000	4.1250	1.4375		
49.974	109.985	29.251	55196	55434	50.800	104.775	36.512	HM807046	HM807010
1.9675	4.3301	1.1516			2.0000	4.1250	1.4375		
49.982	111.125	38.100	546	532	50.800	107.950	32.557	455	452
1.9678	4.3750	1.5000			2.0000	4.2500	1.2818		
49.987	80.962	18.257	L305648	L305610	50.800	109.985	29.251	55200	55434
1.9680	3.1875	.7188			2.0000	4.3301	1.1516		
49.987	89.980	24.750	28579	28520	50.800	109.985	29.251	55200C	55434
1.9680	3.5425	.9744			2.0000	4.3301	1.1516		
49.987	100.000	25.000	378A	372	50.800	110.000	27.000	398	393
1.9680	3.9370	.9842			2.0000	4.3307	1.0630		
49.987	109.985	29.251	55194	55434	50.800	111.125	30.163	HM907643	HM907614
1.9680	4.3301	1.1516			2.0000	4.3750	1.1875		
49.987	114.300	44.450	HH506349	HH506310	50.800	111.125	38.100	537	532
1.9680	4.5000	1.7500			2.0000	4.3750	1.5000		
50.000	90.000	20.000	365	362	50.800	112.712	30.162	3975	3919RB
1.9685	3.5433	.7874			2.0000	4.4375	1.1875		
50.000	95.250	27.783	33887X	33821	50.800	112.712	30.163	39573	39520
1.9685	3.7500	1.0938			2.0000	4.4375	1.1875		
50.000	100.000	34.925	529A	520X	50.800	114.300	44.450	65395	65320
1.9685	3.9370	1.3750			2.0000	4.5000	1.7500		
50.000	101.200	42.895	5360	5320	50.800	117.475	33.338	66200	66461
1.9685	3.9843	1.6888			2.0000	4.6250	1.3125		
50.000	107.950	32.557	465	452	50.800	120.251	44.450	5565	5520
1.9685	4.2500	1.2818			2.0000	4.7343	1.7500		
50.000	110.000	27.000	396	393	50.800	120.650	41.275	619	612
1.9685	4.3307	1.0630			2.0000	4.7500	1.6250		
50.000	80.000	24.000	X33010	Y33010	50.800	123.825	36.512	72200C	72487
1.9685	3.1496	.9449			2.0000	4.8750	1.4375		
50.000	85.000	26.000	X33110	Y33110	50.800	123.825	36.512	72200	72487
1.9685	3.3465	1.0236			2.0000	4.8750	1.4375		
50.000	90.000	24.750	X32210M	Y32210M	50.800	123.825	38.100	555	552
1.9685	3.5433	.9744			2.0000	4.8750	1.5000		
50.000	90.000	32.000	X33210	Y33210	50.800	127.000	36.512	HM813836	HM813810
1.9685	3.5433	1.2598			2.0000	5.0000	1.4375		
50.000	110.000	29.250	X31310M	Y31310M	50.800	127.000	44.450	65200	65500
1.9685	4.3307	1.1516			2.0000	5.0000	1.7500		
50.000	110.000	42.250	X32310B	Y32310B	50.800	127.000	50.800	6279	6220
1.9685	4.3307	1.6634			2.0000	5.0000	2.0000		
50.800	77.788	12.700	LL205449	LL205410	50.815	100.000	35.000	XGA33211	Y33211
2.0000	3.0625	.5000			2.0006	3.9370	1.3780		
50.800	80.962	18.257	L305649	L305610	51.592	90.000	20.000	368-S	362
2.0000	3.1875	.7188			2.0312	3.5433	.7874		
50.800	85.000	17.462	18790	18720	51.592	100.000	25.000	377-S	372
2.0000	3.3465	.6875			2.0312	3.9370	.9842		
50.800	85.000	24.500	18200	18335E	52.000	85.000	24.500	18204X	18335E
2.0000	3.3465	.9646			2.0472	3.3465	.9646		
50.800	89.980	24.750	28580	28520	52.000	90.000	21.750	XGA30210	Y30210
2.0000	3.5425	.9744			2.0472	3.5433	.8563		
50.800	90.000	20.000	368	362	52.388	89.980	24.750	28584	28520
2.0000	3.5433	.7874			2.0625	3.5425	.9744		
50.800	95.250	27.783	33889	33821	52.388	95.250	27.783	33890	33821
2.0000	3.7500	1.0938			2.0625	3.7500	1.0938		
50.800	96.838	24.608	28678	28621	52.388	100.000	25.000	377	372
2.0000	3.8125	.9688			2.0625	3.9370	.9842		
50.800	98.425	21.000	385A	382	52.388	100.000	28.173	3767	373
2.0000	3.8750	.8268			2.0625	3.9370	1.1092		
50.800	100.000	25.000	375	372	52.388	107.950	32.557	468	452
2.0000	3.9370	.9842			2.0625	4.2500	1.2818		
50.800	100.000	34.523	3762	373	52.388	109.985	29.251	55206	55434
2.0000	3.9370	1.3592			2.0625	4.3301	1.1516		
50.800	100.000	34.925	529	520X	52.388	109.985	29.251	55206C	55434
2.0000	3.9370	1.3750			2.0625	4.3301	1.1516		
50.800	101.200	39.687	4580	4520	52.388	110.000	36.512	3959	3927X
2.0000	3.9843	1.5625			2.0625	4.3307	1.4375		

15

The Bearing Dimension Catalog is not to be used as a design manual.  
 The cone bore section does not include all available parts – see series for additional information.

# BEARING DIMENSIONS BY CONE BORE

BORE d	OUTSIDE DIAMETER D	WIDTH T	CONE	CUP	BORE d	OUTSIDE DIAMETER D	WIDTH T	CONE	CUP
52.388	111.125	38.100	540	532	55.000	100.000	35.000	X33211M	Y33211M
2.0625	4.3750	1.5000			2.1654	3.9370	1.3780		
53.975	87.312	18.258	L507945	L507910	55.000	120.000	31.500	X30311	Y30311
2.1250	3.4375	.7188			2.1654	4.7244	1.2402		
53.975	88.900	19.050	LM806649	LM806610	55.000	120.000	31.500	X31311M	Y31311M
2.1250	3.5000	.7500			2.1654	4.7244	1.2402		
53.975	88.900	20.241	LM806349C	LM806310	55.000	120.000	45.500	X32311BM	Y32311BM
2.1250	3.5000	.7969			2.1654	4.7244	1.7913		
53.975	95.250	27.783	33895	33821	55.000	98.425	21.000	385	382
2.1250	3.7500	1.0938			2.1654	3.8750	.8268		
53.975	98.425	21.000	389A	382	55.000	120.000	29.794	475	472
2.1250	3.8750	.8268			2.1654	4.7244	1.1730		
53.975	104.775	30.162	45287	45220	55.000	120.650	41.275	622X	612
2.1250	4.1250	1.1875			2.1654	4.7500	1.6250		
53.975	104.775	36.512	HM807049	HM807010	55.000	123.825	38.100	557	552
2.1250	4.1250	1.4375			2.1654	4.8750	1.5000		
53.975	107.950	32.557	456	452	55.006	120.650	41.275	622A	612
2.1250	4.2500	1.2818			2.1656	4.7500	1.6250		
53.975	109.985	29.251	55212C	55434	55.474	98.425	21.000	386	382
2.1250	4.3301	1.1516			2.1840	3.8750	.8268		
53.975	111.125	38.100	539	532	55.562	96.838	24.608	28680	28621
2.1250	4.3750	1.5000			2.1875	3.8125	.9688		
53.975	112.712	30.163	39578	39520	55.562	107.950	32.557	466-S	452
2.1250	4.4375	1.1875			2.1875	4.2500	1.2818		
53.975	117.475	33.338	66212	66461	55.562	120.251	44.450	5566	5520
2.1250	4.6250	1.3125			2.1875	4.7343	1.7500		
53.975	120.251	44.450	5577	5520	55.562	123.825	36.512	72218C	72487
2.1250	4.7343	1.7500			2.1875	4.8750	1.4375		
53.975	120.650	41.275	621	612	55.562	123.825	36.512	72218	72487
2.1250	4.7500	1.6250			2.1875	4.8750	1.4375		
53.975	122.238	33.338	66584	66520	55.562	127.000	36.512	HM813840	HM813810
2.1250	4.8125	1.3125			2.1875	5.0000	1.4375		
53.975	123.825	36.512	72212C	72487	55.575	98.425	21.000	389	382
2.1250	4.8750	1.4375			2.1880	3.8750	.8268		
53.975	123.825	36.512	72212	72487	55.753	122.238	33.338	66583	66520
2.1250	4.8750	1.4375			2.1950	4.8125	1.3125		
53.975	123.825	38.100	557-S	552	57.150	87.312	18.258	L507949	L507910
2.1250	4.8750	1.5000			2.2500	3.4375	.7188		
53.975	127.000	44.450	65212	65500	57.150	96.838	24.608	28682	28621
2.1250	5.0000	1.7500			2.2500	3.8125	.9688		
53.975	127.000	50.800	6280	6220	57.150	98.425	21.000	387	382
2.1250	5.0000	2.0000			2.2500	3.8750	.8268		
53.975	130.175	36.513	HM911242	HM911210	57.150	104.775	30.162	45289	45220
2.1250	5.1250	1.4375			2.2500	4.1250	1.1875		
53.975	136.525	36.513	78214	78537	57.150	107.950	32.557	462	452
2.1250	5.3750	1.4375			2.2500	4.2500	1.2818		
53.975	136.525	36.513	78214C	78537	57.150	110.000	27.000	390	393
2.1250	5.3750	1.4375			2.2500	4.3307	1.0630		
53.975	136.525	41.275	636	632	57.150	112.712	25.400	29665	29620
2.1250	5.3750	1.6250			2.2500	4.4375	1.0000		
54.488	104.775	36.512	HM807048	HM807010	57.150	112.712	30.163	39580	39520
2.1452	4.1250	1.4375			2.2500	4.4375	1.1875		
54.813	135.755	53.975	6380	6320	57.150	112.712	36.512	3958	3919RB
2.1580	5.3447	2.1250			2.2500	4.4375	1.4375		
54.988	107.950	32.557	466	452	57.150	117.475	30.162	33225	33461
2.1649	4.2500	1.2818			2.2500	4.6250	1.1875		
54.988	111.125	38.100	538	532	57.150	117.475	33.338	66225	66461
2.1649	4.3750	1.5000			2.2500	4.6250	1.3125		
54.988	135.755	53.975	6381	6320	57.150	120.650	41.275	623	612
2.1649	5.3447	2.1250			2.2500	4.7500	1.6250		
54.996	99.979	24.605	28970	28919	57.150	122.238	33.338	66587	66520
2.1652	3.9362	.9687			2.2500	4.8125	1.3125		
55.000	90.000	23.000	X32011X	Y32011X	57.150	123.825	36.512	72225C	72487
2.1654	3.5433	.9055			2.2500	4.8750	1.4375		
55.000	90.000	27.000	X33011	Y33011	57.150	123.825	36.512	72225	72487
2.1654	3.5433	1.0630			2.2500	4.8750	1.4375		
55.000	95.000	30.000	X33111	Y33111	57.150	123.825	38.100	555-S	552
2.1654	3.7402	1.1811			2.2500	4.8750	1.5000		
55.000	100.000	22.750	X30211M	Y30211M	57.150	127.000	44.450	65225	65500
2.1654	3.9370	.8957			2.2500	5.0000	1.7500		

15

BEARING DIMENSIONS BY CONE BORE

BORE d	OUTSIDE DIAMETER D	WIDTH T	CONE	CUP	BORE d	OUTSIDE DIAMETER D	WIDTH T	CONE	CUP
57.150	135.755	53.975	6375	6320	60.000	100.000	30.000	X33112	Y33112
2.2500	5.3447	2.1250			2.3622	3.9370	1.1811		
57.150	136.525	36.513	78225	78537	60.000	110.000	23.750	X30212M	Y30212M
2.2500	5.3750	1.4375			2.3622	4.3307	.9350		
57.150	136.525	36.513	78225C	78537	60.000	110.000	29.750	X32212M	Y32212M
2.2500	5.3750	1.4375			2.3622	4.3307	1.1713		
57.150	136.525	41.275	635	632	60.000	130.000	33.500	X30312M	Y30312M
2.2500	5.3750	1.6250			2.3622	5.1181	1.3189		
57.150	149.225	53.975	6455	6420	60.000	130.000	33.500	X31312M	Y31312M
2.2500	5.8750	2.1250			2.3622	5.1181	1.3189		
57.150	152.400	53.975	HH814540	HH814510	60.000	130.000	48.500	X32312B	Y32312B
2.2500	6.0000	2.1250			2.3622	5.1181	1.9094		
57.531	98.425	21.000	388A	382	60.325	99.979	24.605	28985	28919
2.2650	3.8750	.8268			2.3750	3.9362	.9687		
57.981	98.425	21.000	388XS	382	60.325	103.213	17.247	L812144	L812111
2.2827	3.8750	.8268			2.3750	4.0635	.6790		
58.738	112.712	30.162	3981	3919RB	60.325	112.712	36.512	3960	3919RB
2.3125	4.4375	1.1875			2.3750	4.4375	1.4375		
58.738	127.000	44.450	65231	65500	60.325	120.251	44.450	5582	5520
2.3125	5.0000	1.7500			2.3750	4.7343	1.7500		
59.530	112.712	30.162	3978	3919RB	60.325	122.238	38.100	HM212044	HM212010
2.3437	4.4375	1.1875			2.3750	4.8125	1.5000		
59.880	127.000	44.450	65235	65500	60.325	123.825	38.100	557A	552
2.3575	5.0000	1.7500			2.3750	4.8750	1.5000		
59.931	150.089	44.450	745	742	60.325	127.000	36.512	HM813841	HM813810
2.3595	5.9090	1.7500			2.3750	5.0000	1.4375		
59.972	122.238	33.338	66589	66520	60.325	127.000	44.450	65237	65500
2.3611	4.8125	1.3125			2.3750	5.0000	1.7500		
59.977	99.979	24.605	28980	28919	60.325	130.175	36.513	HM911245	HM911210
2.3613	3.9362	.9687			2.3750	5.1250	1.4375		
59.977	122.238	33.338	66586	66520	60.325	135.755	53.975	6376	6320
2.3613	4.8125	1.3125			2.3750	5.3447	2.1250		
59.987	104.775	21.433	39236	39412	60.325	136.525	36.513	78238	78537
2.3617	4.1250	.8438			2.3750	5.3750	1.4375		
59.987	112.712	30.162	3977X	3919RB	60.325	136.525	36.513	78238C	78537
2.3617	4.4375	1.1875			2.3750	5.3750	1.4375		
59.987	123.825	38.100	558-S	552	60.325	136.525	41.275	637	632
2.3617	4.8750	1.5000			2.3750	5.3750	1.6250		
59.987	127.000	36.512	HM813839	HM813810	60.325	139.700	46.038	H715332	H715310
2.3617	5.0000	1.4375			2.3750	5.5000	1.8125		
59.987	130.175	34.100	HM911244	HM911210	60.325	152.400	52.705	HH814542	HH814510
2.3617	5.1250	1.3425			2.3750	6.0000	2.0750		
59.987	135.755	53.975	6391	6320	60.325	161.925	47.625	9275	9220
2.3617	5.3447	2.1250			2.3750	6.3750	1.8750		
59.987	146.050	41.275	H913840	H913810	61.912	110.000	27.000	392	393
2.3617	5.7500	1.6250			2.4375	4.3307	1.0630		
60.000	107.950	25.400	29580	29520	61.912	123.825	38.100	554	552
2.3622	4.2500	1.0000			2.4375	4.8750	1.5000		
60.000	110.000	27.000	397	393	61.912	127.000	36.512	HM813843	HM813810
2.3622	4.3307	1.0630			2.4375	5.0000	1.4375		
60.000	112.712	30.162	3977	3919RB	61.912	130.175	36.513	HM911249	HM911210
2.3622	4.4375	1.1875			2.4375	5.1250	1.4375		
60.000	112.712	30.163	39582A	39520	61.912	139.700	46.038	H715334	H715310
2.3622	4.4375	1.1875			2.4375	5.5000	1.8125		
60.000	120.000	29.794	476	472	61.912	146.050	41.275	H913842	H913810
2.3622	4.7244	1.1730			2.4375	5.7500	1.6250		
60.000	120.251	44.998	5569	5520	61.912	158.750	55.562	9178	9120
2.3622	4.7343	1.7716			2.4375	6.2500	2.1875		
60.000	122.238	33.338	66585	66520	61.976	99.979	23.813	28990	28919
2.3622	4.8125	1.3125			2.4400	3.9362	.9375		
60.000	123.825	38.100	558X	552	62.738	99.979	24.605	28995	28919
2.3622	4.8750	1.5000			2.4700	3.9362	.9687		
60.000	135.755	53.975	6361	6320	63.487	94.976	17.000	L910349	L910310
2.3622	5.3447	2.1250			2.4995	3.7392	.6693		
60.000	150.089	44.450	746	742	63.500	92.075	13.495	LL510749	LL510710
2.3622	5.9090	1.7500			2.5000	3.6250	.5313		
60.000	95.000	23.000	X32012X	Y32012X	63.500	94.458	19.050	L610549	L610510
2.3622	3.7402	.9055			2.5000	3.7188	.7500		
60.000	95.000	27.000	X33012	Y33012	63.500	101.600	25.400	LM110848	LM110811
2.3622	3.7402	1.0630			2.5000	4.0000	1.0000		



The Bearing Dimension Catalog is not to be used as a design manual.  
The cone bore section does not include all available parts – see series for additional information.

## BEARING DIMENSIONS BY CONE BORE

BORE d	OUTSIDE DIAMETER D	WIDTH T	CONE	CUP	BORE d	OUTSIDE DIAMETER D	WIDTH T	CONE	CUP
63.500	104.775	21.433	39250	39412	65.000	100.000	27.000	X33013	Y33013
2.5000	4.1250	.8438			2.5591	3.9370	1.0630		
63.500	107.950	25.398	M111048	M111012	65.000	110.000	34.000	X33113	Y33113
2.5000	4.2500	.9999			2.5591	4.3307	1.3386		
63.500	107.950	25.400	29585	29520	65.000	120.000	24.750	X30213M	Y30213M
2.5000	4.2500	1.0000			2.5591	4.7244	.9744		
63.500	110.000	27.000	390A	393	65.000	120.000	32.750	X32213	YAA32213
2.5000	4.3307	1.0630			2.5591	4.7244	1.2894		
63.500	112.712	25.400	29670	29620	65.000	120.000	41.000	X33213M	Y33213M
2.5000	4.4375	1.0000			2.5591	4.7244	1.6142		
63.500	112.712	30.163	39585	39520	65.000	140.000	36.000	X30313	Y30313
2.5000	4.4375	1.1875			2.5591	5.5118	1.4173		
63.500	112.712	36.512	3955	3919RB	65.000	140.000	36.000	X31313M	Y31313M
2.5000	4.4375	1.4375			2.5591	5.5118	1.4173		
63.500	117.475	30.162	33251	33461	65.000	140.000	51.000	X32313M	Y32313M
2.5000	4.6250	1.1875			2.5591	5.5118	2.0079		
63.500	120.000	29.794	477	472	65.000	110.000	27.000	399	393
2.5000	4.7244	1.1730			2.5591	4.3307	1.0630		
63.500	120.251	52.387	5552	5520	65.000	120.000	29.794	478	472
2.5000	4.7343	2.0625			2.5591	4.7244	1.1730		
63.500	122.238	38.100	HM212046	HM212010	65.000	135.755	53.975	6385-S	6320
2.5000	4.8125	1.5000			2.5591	5.3447	2.1250		
63.500	123.825	38.100	559	552	65.088	135.755	63.500	6377	6320
2.5000	4.8750	1.5000			2.5625	5.3447	2.5000		
63.500	127.000	36.512	HM813842	HM813810	65.088	139.700	46.038	H715340	H715310
2.5000	5.0000	1.4375			2.5625	5.5000	1.8125		
63.500	130.048	36.512	565	562	65.883	120.251	44.450	5595	5520
2.5000	5.1200	1.4375			2.5938	4.7343	1.7500		
63.500	135.755	53.975	6382	6320	65.987	123.975	41.500	H212749	H212710
2.5000	5.3447	2.1250			2.5979	4.8809	1.6339		
63.500	136.525	36.513	78250	78537	66.650	112.712	30.163	39590A	39520
2.5000	5.3750	1.4375			2.6240	4.4375	1.1875		
63.500	136.525	36.513	78248C	78537	66.675	103.213	17.247	L812147	L812111
2.5000	5.3750	1.4375			2.6250	4.0635	.6790		
63.500	136.525	41.275	H414235	H414210	66.675	107.950	25.400	29590	29520
2.5000	5.3750	1.6250			2.6250	4.2500	1.0000		
63.500	136.525	41.275	639	632	66.675	110.000	27.000	395A	393
2.5000	5.3750	1.6250			2.6250	4.3307	1.0630		
63.500	139.700	46.038	H715336	H715310	66.675	112.712	30.162	3984	3919RB
2.5000	5.5000	1.8125			2.6250	4.4375	1.1875		
63.500	149.225	53.975	6475	6420	66.675	112.712	30.163	39589	39520
2.5000	5.8750	2.1250			2.6250	4.4375	1.1875		
63.500	150.089	44.450	745-S	742	66.675	117.475	30.162	33261	33461
2.5000	5.9090	1.7500			2.6250	4.6250	1.1875		
63.500	177.800	57.150	HH914447	HH914412	66.675	120.000	29.794	478-S	472
2.5000	7.0000	2.2500			2.6250	4.7244	1.1730		
64.000	104.775	21.433	39252X	39412	66.675	122.238	38.100	HM212049	HM212010
2.5197	4.1250	.8438			2.6250	4.8125	1.5000		
64.960	149.225	53.975	6464	6420	66.675	123.825	38.100	560	552
2.5575	5.8750	2.1250			2.6250	4.8750	1.5000		
64.960	150.089	44.450	747-S	742	66.675	127.000	36.512	HM813844	HM813810
2.5575	5.9090	1.7500			2.6250	5.0000	1.4375		
64.960	152.400	41.275	656	652	66.675	133.350	30.163	495AA	492A
2.5575	6.0000	1.6250			2.6250	5.2500	1.1875		
64.963	130.048	36.512	569	562	66.675	135.755	53.975	6386	6320
2.5576	5.1200	1.4375			2.6250	5.3447	2.1250		
64.973	110.000	27.000	396-S	393	66.675	136.525	41.275	H414242	H414210
2.5580	4.3307	1.0630			2.6250	5.3750	1.6250		
64.973	135.755	53.975	6385	6320	66.675	136.525	41.275	641	632
2.5580	5.3447	2.1250			2.6250	5.3750	1.6250		
64.988	107.950	25.400	29588	29520	66.675	139.700	46.038	H715341	H715310
2.5586	4.2500	1.0000			2.6250	5.5000	1.8125		
64.988	112.712	30.163	39586	39520	66.675	152.400	53.975	HH814547	HH814510
2.5586	4.4375	1.1875			2.6250	6.0000	2.1250		
64.988	120.000	29.794	478XA	472	66.675	177.800	57.150	HH914449	HH914412
2.5586	4.7244	1.1730			2.6250	7.0000	2.2500		
64.988	136.525	36.513	78255X	78537	68.262	110.000	27.000	399A	393
2.5586	5.3750	1.4375			2.6875	4.3307	1.0630		
65.000	100.000	23.000	X32013X	Y32013X	68.262	117.475	30.162	33269	33461
2.5591	3.9370	.9055			2.6875	4.6250	1.1875		

15



**BEARING DIMENSIONS BY CONE BORE**

BORE d	OUTSIDE DIAMETER D	WIDTH T	CONE	CUP	BORE d	OUTSIDE DIAMETER D	WIDTH T	CONE	CUP
68.262	120.000	29.794	480	472	70.000	130.048	36.512	570X	562
2.6875	4.7244	1.1730			2.7559	5.1200	1.4375		
68.262	120.251	52.387	5557	5520	70.000	140.000	43.002	HM515737	HM515714
2.6875	4.7343	2.0625			2.7559	5.5118	1.6930		
68.262	123.825	38.100	560-S	552	70.000	149.225	53.975	6459	6420
2.6875	4.8750	1.5000			2.7559	5.8750	2.1250		
68.262	130.048	36.512	570	562	70.000	110.000	25.000	X32014X	Y32014X
2.6875	5.1200	1.4375			2.7559	4.3307	.9843		
68.262	136.525	41.275	H414245	H414210	70.000	110.000	31.000	X33014M	Y33014M
2.6875	5.3750	1.6250			2.7559	4.3307	1.2205		
68.262	136.525	41.275	642	632	70.000	120.000	37.000	X33114	Y33114
2.6875	5.3750	1.6250			2.7559	4.7244	1.4567		
68.262	139.700	46.038	H715343	H715310	70.000	125.000	26.250	X30214M	Y30214M
2.6875	5.5000	1.8125			2.7559	4.9213	1.0335		
68.262	152.400	47.626	H914841	H914811	70.000	125.000	33.250	X32214M	Y32214M
2.6875	6.0000	1.8750			2.7559	4.9213	1.3091		
68.262	158.750	50.800	9185	9120	70.000	125.000	41.000	X33214	Y33214
2.6875	6.2500	2.0000			2.7559	4.9213	1.6142		
68.262	161.925	49.212	9278	9220	70.000	150.000	38.000	X31314M	Y31314M
2.6875	6.3750	1.9375			2.7559	5.9055	1.4961		
69.850	98.425	13.495	LL713049	LL713010	70.000	150.000	38.000	X30314	Y30314
2.7500	3.8750	.5313			2.7559	5.9055	1.4961		
69.850	99.217	17.000	LL713149	LL713110	70.000	150.000	54.000	X32314M	Y32314M
2.7500	3.9062	.6693			2.7559	5.9055	2.1260		
69.850	101.600	19.050	L713049	L713010	70.637	112.712	25.400	29680	29620
2.7500	4.0000	.7500			2.7810	4.4375	1.0000		
69.850	112.712	22.225	LM613449	LM613410	71.412	130.048	36.512	567AA	562
2.7500	4.4375	.8750			2.8115	5.1200	1.4375		
69.850	112.712	25.400	29675	29620	71.438	117.475	30.162	33281	33461
2.7500	4.4375	1.0000			2.8125	4.6250	1.1875		
69.850	117.475	30.162	33275	33461	71.438	120.000	32.545	47490	47420
2.7500	4.6250	1.1875			2.8125	4.7244	1.2813		
69.850	120.000	29.794	482	472	71.438	127.000	36.512	HM813849	HM813810
2.7500	4.7244	1.1730			2.8125	5.0000	1.4375		
69.850	120.000	32.545	47487	47420	71.438	130.048	36.512	567A	562
2.7500	4.7244	1.2813			2.8125	5.1200	1.4375		
69.850	127.000	36.512	HM813846	HM813810	71.438	133.350	30.163	495-S	492A
2.7500	5.0000	1.4375			2.8125	5.2500	1.1875		
69.850	130.048	36.512	566	562	71.438	133.350	33.337	47675	47620
2.7500	5.1200	1.4375			2.8125	5.2500	1.3125		
69.850	136.525	41.275	643	632	71.438	136.525	41.275	H414249	H414210
2.7500	5.3750	1.6250			2.8125	5.3750	1.6250		
69.850	139.700	46.038	H715344	H715310	71.438	136.525	41.275	644	632
2.7500	5.5000	1.8125			2.8125	5.3750	1.6250		
69.850	146.050	36.512	HM914545	HM914510	71.438	139.700	46.038	H715345	H715310
2.7500	5.7500	1.4375			2.8125	5.5000	1.8125		
69.850	146.050	41.275	H913849	H913810	73.025	112.712	25.400	29685	29620
2.7500	5.7500	1.6250			2.8750	4.4375	1.0000		
69.850	149.225	53.975	6454	6420	73.025	117.475	25.400	LM814845	LM814810
2.7500	5.8750	2.1250			2.8750	4.6250	1.0000		
69.850	150.089	44.450	744A	742	73.025	117.475	30.162	33287	33461
2.7500	5.9090	1.7500			2.8750	4.6250	1.1875		
69.850	152.400	41.275	655	652	73.025	123.825	38.887	M514546	M514512
2.7500	6.0000	1.6250			2.8750	4.8750	1.5310		
69.850	168.275	53.975	835	832	73.025	125.412	25.400	27680	27620
2.7500	6.6250	2.1250			2.8750	4.9375	1.0000		
69.914	177.800	52.387	9382	9320	73.025	127.000	30.163	42683	42620
2.7525	7.0000	2.0625			2.8750	5.0000	1.1875		
69.952	120.000	23.000	34274	34472X	73.025	130.048	36.512	567	562
2.7540	4.7244	.9055			2.8750	5.1200	1.4375		
69.987	139.700	46.038	H715347	H715310	73.025	139.992	36.513	576	572
2.7554	5.5000	1.8125			2.8750	5.5115	1.4375		
69.987	176.212	54.770	H916642	H916610	73.025	140.000	50.800	HM515741	HM515714
2.7554	6.9375	2.1563			2.8750	5.5118	2.0000		
70.000	112.712	25.400	29677	29620	73.025	142.138	50.800	5752	5720
2.7559	4.4375	1.0000			2.8750	5.5960	2.0000		
70.000	120.000	23.000	34275	34472X	73.025	149.225	53.975	6460	6420
2.7559	4.7244	.9055			2.8750	5.8750	2.1250		
70.000	120.000	29.794	484	472	73.025	150.089	44.450	744	742
2.7559	4.7244	1.1730			2.8750	5.9090	1.7500		

**15**

The Bearing Dimension Catalog is not to be used as a design manual.  
The cone bore section does not include all available parts – see series for additional information.

# BEARING DIMENSIONS BY CONE BORE

BORE d	OUTSIDE DIAMETER D	WIDTH T	CONE	CUP	BORE d	OUTSIDE DIAMETER D	WIDTH T	CONE	CUP
73.025	152.400	41.275	657	652	76.200	149.225	53.975	6461	6420
2.8750	6.0000	1.6250			3.0000	5.8750	2.1250		
73.025	161.925	47.625	762	752	76.200	150.089	44.450	748-S	742
2.8750	6.3750	1.8750			3.0000	5.9090	1.7500		
73.817	112.712	25.400	29688	29620	76.200	152.400	39.688	590A	592
2.9062	4.4375	1.0000			3.0000	6.0000	1.5625		
73.817	130.048	36.512	568	562	76.200	152.400	41.275	659	652
2.9062	5.1200	1.4375			3.0000	6.0000	1.6250		
74.612	139.992	36.513	577	572	76.200	161.925	47.625	755	752
2.9375	5.5115	1.4375			3.0000	6.3750	1.8750		
74.612	152.400	41.275	658	652	76.200	161.925	49.212	9285	9220
2.9375	6.0000	1.6250			3.0000	6.3750	1.9375		
74.976	120.000	23.000	34294	34472X	76.200	168.275	53.975	837	832
2.9518	4.7244	.9055			3.0000	6.6250	2.1250		
74.988	127.000	30.163	42686	42620	76.200	169.850	62.705	6554	6520
2.9523	5.0000	1.1875			3.0000	6.6870	2.4687		
75.000	115.000	25.000	X32015X	Y32015X	76.200	177.800	55.562	9378	9320
2.9528	4.5276	.9843			3.0000	7.0000	2.1875		
75.000	115.000	31.000	X33015	Y33015	76.200	180.975	53.975	H917840	H917810
2.9528	4.5276	1.2205			3.0000	7.1250	2.1250		
75.000	125.000	37.000	X33115	Y33115	76.200	190.500	57.150	HH221430	HH221410
2.9528	4.9213	1.4567			3.0000	7.5000	2.2500		
75.000	130.000	27.250	X30215M	Y30215M	77.356	120.000	23.000	34304	34472X
2.9528	5.1181	1.0728			3.0455	4.7244	.9055		
75.000	130.000	33.250	X32215M	Y32215M	77.788	117.475	25.400	LM814849	LM814810
2.9528	5.1181	1.3091			3.0625	4.6250	1.0000		
75.000	130.000	41.000	X33215M	Y33215M	77.788	120.000	23.000	34306	34472X
2.9528	5.1181	1.6142			3.0625	4.7244	.9055		
75.000	160.000	40.000	X30315M	Y30315M	77.788	127.000	30.163	42690	42620
2.9528	6.2992	1.5748			3.0625	5.0000	1.1875		
75.000	160.000	40.000	X31315M	Y31315M	77.788	133.350	30.163	495AS	492A
2.9528	6.2992	1.5748			3.0625	5.2500	1.1875		
75.000	130.048	36.512	568X	562	77.788	139.700	46.038	H715348	H715310
2.9528	5.1200	1.4375			3.0625	5.5000	1.8125		
75.000	133.350	30.163	497X	492A	77.788	142.138	44.450	5795	5720
2.9528	5.2500	1.1875			3.0625	5.5960	1.7500		
75.987	131.976	39.000	HM215249	HM215210	77.788	146.050	33.337	47880	47820
2.9916	5.1959	1.5354			3.0625	5.7500	1.3125		
76.000	120.000	23.000	34299X	34472X	77.788	164.976	49.500	H816249	H816210
2.9921	4.7244	.9055			3.0625	6.4951	1.9488		
76.162	169.850	53.975	6574P	6520	79.375	140.000	44.450	HM515749	HM515714
2.9985	6.6870	2.1250			3.1250	5.5118	1.7500		
76.200	98.425	11.112	EL914049	EL914010	79.375	150.089	44.450	750	742
3.0000	3.8750	.4375			3.1250	5.9090	1.7500		
76.200	105.570	13.495	LL714649	LL714610	79.375	152.400	39.688	595A	592
3.0000	4.1563	.5313			3.1250	6.0000	1.5625		
76.200	109.538	19.050	L814749	L814710	79.375	152.400	41.275	661	652
3.0000	4.3125	.7500			3.1250	6.0000	1.6250		
76.200	115.888	26.987	LM114848	LM114811	79.375	161.925	47.625	756A	752
3.0000	4.5625	1.0625			3.1250	6.3750	1.8750		
76.200	120.000	23.000	34300	34472X	79.375	190.500	57.150	HH221431	HH221410
3.0000	4.7244	.9055			3.1250	7.5000	2.2500		
76.200	125.412	25.400	27684	27620	79.974	129.974	26.987	LM716446	LM716411
3.0000	4.9375	1.0000			3.1486	5.1171	1.0625		
76.200	127.000	30.163	42687	42620	79.974	146.975	40.000	HM218238	HM218210
3.0000	5.0000	1.1875			3.1486	5.7864	1.5748		
76.200	133.350	30.163	495A	492A	79.985	133.350	30.163	496X	492A
3.0000	5.2500	1.1875			3.1490	5.2500	1.1875		
76.200	133.350	33.337	47678	47620	79.985	139.992	36.513	578	572
3.0000	5.2500	1.3125			3.1490	5.5115	1.4375		
76.200	133.350	39.687	HM516442	HM516410	79.985	152.400	39.688	590	592
3.0000	5.2500	1.5625			3.1490	6.0000	1.5625		
76.200	139.700	46.038	H715346	H715310	79.992	139.992	36.513	578W	572
3.0000	5.5000	1.8125			3.1493	5.5115	1.4375		
76.200	139.992	36.513	575	572	80.000	150.089	44.450	748	742
3.0000	5.5115	1.4375			3.1496	5.9090	1.7500		
76.200	140.000	44.450	HM515745	HM515714	80.000	200.000	52.761	98316	98788
3.0000	5.5118	1.7500			3.1496	7.8740	2.0772		
76.200	142.138	50.800	5755	5720	80.000	125.000	29.000	X32016X	Y32016X
3.0000	5.5960	2.0000			3.1496	4.9213	1.1417		

15

**BEARING DIMENSIONS BY CONE BORE**

BORE d	OUTSIDE DIAMETER D	WIDTH T	CONE	CUP	BORE d	OUTSIDE DIAMETER D	WIDTH T	CONE	CUP
80.000	130.000	37.000	X33116M	Y33116M	84.138	152.400	41.275	664	652
3.1496	5.1181	1.4567			3.3125	6.0000	1.6250		
80.000	140.000	28.250	X30216M	Y30216M	84.138	177.800	52.387	9386H	9320
3.1496	5.5118	1.1122			3.3125	7.0000	2.0625		
80.000	140.000	35.250	X32216M	Y32216M	84.138	193.675	52.000	H919942	H919911
3.1496	5.5118	1.3878			3.3125	7.6250	2.0472		
80.000	140.000	46.000	X33216	Y33216	84.976	125.412	25.400	27695	27620
3.1496	5.5118	1.8110			3.3455	4.9375	1.0000		
80.000	170.000	42.500	X30316M	Y30316M	84.976	133.350	30.163	499A	492A
3.1496	6.6929	1.6732			3.3455	5.2500	1.1875		
80.000	170.000	61.500	X32316M	Y32316M	85.000	130.000	29.000	X32017X	Y32017X
3.1496	6.6929	2.4213			3.3465	5.1181	1.1417		
80.962	133.350	30.163	496	492A	85.000	130.000	36.000	X33017	Y33017
3.1875	5.2500	1.1875			3.3465	5.1181	1.4173		
80.962	133.350	33.337	47681	47620	85.000	140.000	41.000	X33117	Y33117
3.1875	5.2500	1.3125			3.3465	5.5118	1.6142		
80.962	133.350	39.687	HM516447	HM516410	85.000	150.000	30.500	X30217M	Y30217M
3.1875	5.2500	1.5625			3.3465	5.9055	1.2008		
80.962	139.992	36.513	581	572	85.000	150.000	38.500	X32217M	Y32217M
3.1875	5.5115	1.4375			3.3465	5.9055	1.5157		
80.962	150.089	44.450	740	742	85.000	150.000	49.000	X33217M	Y33217M
3.1875	5.9090	1.7500			3.3465	5.9055	1.9291		
80.962	152.400	38.100	662	652	85.000	180.000	44.500	X30317M	Y30317M
3.1875	6.0000	1.5000			3.3465	7.0866	1.7520		
80.962	168.275	53.975	838	832	85.000	180.000	63.500	X32317	Y32317
3.1875	6.6250	2.1250			3.3465	7.0866	2.5000		
81.700	133.350	30.163	496AS	492A	85.000	152.400	39.688	599X	592
3.2165	5.2500	1.1875			3.3465	6.0000	1.5625		
82.550	114.300	15.083	LL116249	LL116210	85.000	152.400	41.275	665X	652
3.2500	4.5000	.5938			3.3465	6.0000	1.6250		
82.550	115.888	20.637	L116149	L116110	85.000	161.925	48.006	762X	752
3.2500	4.5625	.8125			3.3465	6.3750	1.8900		
82.550	123.825	28.575	LM116548	LM116511	85.000	188.912	53.297	90334	90744
3.2500	4.8750	1.1250			3.3465	7.4375	2.0983		
82.550	125.412	25.400	27687	27620	85.000	200.000	52.761	98335	98788
3.2500	4.9375	1.0000			3.3465	7.8740	2.0772		
82.550	129.974	26.987	LM716449	LM716411	85.026	150.089	44.450	749	742
3.2500	5.1171	1.0625			3.3475	5.9090	1.7500		
82.550	133.350	30.163	495	492A	85.725	133.350	30.163	497	492A
3.2500	5.2500	1.1875			3.3750	5.2500	1.1875		
82.550	133.350	33.337	47685	47620	85.725	142.138	42.863	HM617048	HM617010
3.2500	5.2500	1.3125			3.3750	5.5960	1.6875		
82.550	133.350	39.687	HM516448	HM516410	85.725	152.400	39.688	596	592
3.2500	5.2500	1.5625			3.3750	6.0000	1.5625		
82.550	139.992	36.513	580	572	85.725	152.400	41.275	665	652
3.2500	5.5115	1.4375			3.3750	6.0000	1.6250		
82.550	142.138	42.863	HM617045	HM617010	85.725	161.925	47.625	758	752
3.2500	5.5960	1.6875			3.3750	6.3750	1.8750		
82.550	150.089	44.450	749A	742	85.725	168.275	41.275	677	672
3.2500	5.9090	1.7500			3.3750	6.6250	1.6250		
82.550	152.400	39.688	595	592	85.725	168.275	53.975	841	832
3.2500	6.0000	1.5625			3.3750	6.6250	2.1250		
82.550	152.400	41.275	663	652	87.312	123.825	20.637	L217847	L217810
3.2500	6.0000	1.6250			3.4375	4.8750	.8125		
82.550	161.925	47.625	756	752	87.312	152.400	39.688	596-S	592
3.2500	6.3750	1.8750			3.4375	6.0000	1.5625		
82.550	168.275	53.975	839	832	87.312	190.500	57.150	HH221432	HH221410
3.2500	6.6250	2.1250			3.4375	7.5000	2.2500		
82.550	169.850	53.975	6559C	6520	87.312	190.500	57.150	869	852
3.2500	6.6870	2.1250			3.4375	7.5000	2.2500		
82.550	180.975	53.975	H917849	H917810	87.960	148.430	28.575	42346	42584
3.2500	7.1250	2.1250			3.4630	5.8437	1.1250		
83.345	125.412	25.400	27688H	27620	88.900	121.442	15.082	LL217849	LL217810
3.2813	4.9375	1.0000			3.5000	4.7812	.5938		
83.345	133.350	33.337	47688	47620	88.900	123.825	20.637	L217849	L217810
3.2813	5.2500	1.3125			3.5000	4.8750	.8125		
84.000	140.000	32.000	XUA32018X	Y32018X	88.900	125.412	19.050	L117549	L117510
3.3071	5.5118	1.2598			3.5000	4.9375	.7500		
84.138	133.350	30.163	498	492A	88.900	130.175	28.574	LM117949	LM117910
3.3125	5.2500	1.1875			3.5000	5.1250	1.1250		

The Bearing Dimension Catalog is not to be used as a design manual.  
The cone bore section does not include all available parts – see series for additional information.

## BEARING DIMENSIONS BY CONE BORE

BORE d	OUTSIDE DIAMETER D	WIDTH T	CONE	CUP	BORE d	OUTSIDE DIAMETER D	WIDTH T	CONE	CUP
88.900	148.430	28.575	42350	42584	92.075	146.050	33.337	47890	47820
3.5000	5.8437	1.1250			3.6250	5.7500	1.3125		
88.900	152.400	39.688	593	592	92.075	148.430	28.575	42362	42584
3.5000	6.0000	1.5625			3.6250	5.8437	1.1250		
88.900	152.400	39.688	HM518445	HM518410	92.075	152.400	39.688	598	592
3.5000	6.0000	1.5625			3.6250	6.0000	1.5625		
88.900	160.096	30.124	69350X	69630	92.075	168.275	41.275	681	672
3.5000	6.3030	1.1860			3.6250	6.6250	1.6250		
88.900	161.925	47.625	759	752	92.075	171.450	47.625	77362	77675
3.5000	6.3750	1.8750			3.6250	6.7500	1.8750		
88.900	168.275	41.275	679	672	92.075	180.975	47.625	778	772
3.5000	6.6250	1.6250			3.6250	7.1250	1.8750		
88.900	168.275	53.975	850	832	92.075	190.500	57.150	HH221438	HH221410
3.5000	6.6250	2.1250			3.6250	7.5000	2.2500		
88.900	169.850	62.705	6552	6520	92.075	190.500	57.150	857	852
3.5000	6.6870	2.4687			3.6250	7.5000	2.2500		
88.900	171.450	47.625	77350	77675	92.075	214.312	73.025	EE213362	213843
3.5000	6.7500	1.8750			3.6250	8.4375	2.8750		
88.900	180.975	47.625	775	772	93.662	148.430	28.575	42368	42584
3.5000	7.1250	1.8750			3.6875	5.8437	1.1250		
88.900	190.500	57.150	HH221434	HH221410	93.662	152.400	39.688	596W	592
3.5000	7.5000	2.2500			3.6875	6.0000	1.5625		
88.900	190.500	57.150	855	852	94.948	190.500	47.625	71373	71750
3.5000	7.5000	2.2500			3.7381	7.5000	1.8750		
88.900	200.000	52.761	98350	98788	94.976	148.430	28.575	42373	42584
3.5000	7.8740	2.0772			3.7392	5.8437	1.1250		
89.090	152.400	39.688	593-S	592	94.976	168.275	41.275	682	672
3.5075	6.0000	1.5625			3.7392	6.6250	1.6250		
89.891	168.275	53.975	850A	832	94.976	190.500	57.150	867A	852
3.5390	6.6250	2.1250			3.7392	7.5000	2.2500		
89.974	146.975	40.000	HM218248	HM218210	94.983	177.800	41.275	64373	64700
3.5423	5.7864	1.5748			3.7395	7.0000	1.6250		
89.974	200.000	52.761	98354	98788	95.000	145.000	32.000	X32019X	Y32019X
3.5423	7.8740	2.0772			3.7402	5.7087	1.2598		
89.980	190.500	63.619	HH221435	HH221410	95.000	145.000	39.000	X33019	Y33019
3.5425	7.5000	2.5047			3.7402	5.7087	1.5354		
89.992	160.096	30.124	69354	69630	95.000	170.000	34.500	X30219M	Y30219M
3.5430	6.3030	1.1860			3.7402	6.6929	1.3583		
90.000	148.430	28.575	42354X	42584	95.000	170.000	45.500	X32219M	Y32219M
3.5433	5.8437	1.1250			3.7402	6.6929	1.7913		
90.000	152.400	39.688	597X	592	95.000	168.275	41.275	683X	672
3.5433	6.0000	1.5625			3.7402	6.6250	1.6250		
90.000	161.925	47.625	767X	752	95.000	190.500	57.150	862	852
3.5433	6.3750	1.8750			3.7402	7.5000	2.2500		
90.000	169.850	53.975	6581X	6520	95.250	128.587	15.875	LL319348	LL319310
3.5433	6.6870	2.1250			3.7500	5.0625	.6250		
90.000	200.000	52.761	98354X	98788	95.250	130.175	20.638	L319249	L319210
3.5433	7.8740	2.0772			3.7500	5.1250	.8125		
90.000	140.000	32.000	X32018X	Y32018X	95.250	136.525	30.162	LM119348	LM119311
3.5433	5.5118	1.2598			3.7500	5.3750	1.1875		
90.000	140.000	39.000	X33018	Y33018	95.250	146.050	33.337	47896	47820
3.5433	5.5118	1.5354			3.7500	5.7500	1.3125		
90.000	150.000	45.000	X33118M	Y33118M	95.250	148.430	28.575	42375	42584
3.5433	5.9055	1.7717			3.7500	5.8437	1.1250		
90.000	160.000	32.500	X30218M	Y30218M	95.250	152.400	39.688	594	592
3.5433	6.2992	1.2795			3.7500	6.0000	1.5625		
90.000	160.000	42.500	X32218M	Y32218M	95.250	157.162	36.512	52375	52618
3.5433	6.2992	1.6732			3.7500	6.1875	1.4375		
90.000	190.000	46.500	X31318M	Y31318M	95.250	168.275	41.275	683	672
3.5433	7.4803	1.8307			3.7500	6.6250	1.6250		
90.488	161.925	47.625	760	752	95.250	171.450	47.625	77375	77675
3.5625	6.3750	1.8750			3.7500	6.7500	1.8750		
91.351	152.400	39.688	597A	592	95.250	180.975	47.625	776	772
3.5965	6.0000	1.5625			3.7500	7.1250	1.8750		
91.973	142.875	30.000	LM718947	LM718910	95.250	190.500	57.150	HH221440	HH221410
3.6210	5.6250	1.1811			3.7500	7.5000	2.2500		
92.075	130.175	20.638	L319245	L319210	95.250	190.500	57.150	864	852
3.6250	5.1250	.8125			3.7500	7.5000	2.2500		
92.075	130.175	28.575	LM218948	LM218911	95.250	200.025	73.025	EH220749	EH220710
3.6250	5.1250	1.1250			3.7500	7.8750	2.8750		

15

## BEARING DIMENSIONS BY CONE BORE

BORE d	OUTSIDE DIAMETER D	WIDTH T	CONE	CUP	BORE d	OUTSIDE DIAMETER D	WIDTH T	CONE	CUP
96.838	148.430	28.575	42381	42584	101.600	177.800	34.925	LM921845	LM921810
3.8125	5.8437	1.1250			4.0000	7.0000	1.3750		
96.838	188.912	50.800	90381	90744	101.600	180.975	47.625	780	772
3.8125	7.4375	2.0000			4.0000	7.1250	1.8750		
98.425	157.162	36.512	52387	52618	101.600	190.500	57.150	HH221449	HH221410
3.8750	6.1875	1.4375			4.0000	7.5000	2.2500		
98.425	168.275	41.275	685	672	101.600	190.500	57.150	861	852
3.8750	6.6250	1.6250			4.0000	7.5000	2.2500		
98.425	180.975	47.625	779	772	101.600	200.000	52.761	98400	98788
3.8750	7.1250	1.8750			4.0000	7.8740	2.0772		
98.425	184.150	63.500	HH421246C	HH421210	101.600	206.375	66.675	941	930
3.8750	7.2500	2.5000			4.0000	8.1250	2.6250		
98.425	190.500	57.150	HH221442	HH221410	101.600	212.725	66.674	HH224335	HH224310
3.8750	7.5000	2.2500			4.0000	8.3750	2.6250		
98.425	190.500	57.150	866	852	101.600	214.312	55.562	H924033	H924010
3.8750	7.5000	2.2500			4.0000	8.4375	2.1875		
98.425	206.375	66.675	943	930	101.600	250.825	76.200	EE215040	215096
3.8750	8.1250	2.6250			4.0000	9.8750	3.0000		
98.425	212.725	66.674	HH224332	HH224310	101.600	250.825	76.200	HH923649	HH923610
3.8750	8.3750	2.6250			4.0000	9.8750	3.0000		
99.212	171.450	49.213	HM321245	HM321210	103.188	168.275	41.275	689	672
3.9060	6.7500	1.9375			4.0625	6.6250	1.6250		
99.898	200.000	52.761	98393	98788	104.775	142.083	15.875	LL521845	LL521810
3.9330	7.8740	2.0772			4.1250	5.5938	.6250		
99.974	146.050	25.400	LM720646	LM720610	104.775	180.975	47.625	782	772
3.9360	5.7500	1.0000			4.1250	7.1250	1.8750		
99.974	156.975	42.000	HM220145	HM220110	104.775	190.500	47.625	71412	71750
3.9360	6.1801	1.6535			4.1250	7.5000	1.8750		
99.974	180.975	47.625	783A	772	105.000	160.000	35.000	X32021X	Y32021X
3.9360	7.1250	1.8750			4.1339	6.2992	1.3780		
99.974	206.375	66.675	944A	930	105.000	160.000	43.000	X33021M	Y33021M
3.9360	8.1250	2.6250			4.1339	6.2992	1.6929		
99.974	212.725	66.674	HH224334	HH224310	105.000	190.000	39.000	X30221M	Y30221M
3.9360	8.3750	2.6250			4.1339	7.4803	1.5354		
99.982	190.500	57.150	HH221447	HH221410	105.000	190.000	53.000	X32221M	Y32221M
3.9363	7.5000	2.2500			4.1339	7.4803	2.0866		
100.000	157.162	36.512	52394X	52618	106.000	160.000	35.000	XGA32021X	Y32021X
3.9370	6.1875	1.4375			4.1732	6.2992	1.3780		
100.000	180.975	47.625	783	772	106.362	165.100	36.512	56418	56650
3.9370	7.1250	1.8750			4.1875	6.5000	1.4375		
100.000	190.500	57.150	863X	852	106.975	146.975	28.500	LM121349	LM121310
3.9370	7.5000	2.2500			4.2116	5.7864	1.1220		
100.000	200.000	52.761	98394X	98788	107.874	146.050	21.432	L521948	L521910
3.9370	7.8740	2.0772			4.2470	5.7500	.8438		
100.000	150.000	32.000	X32020X	Y32020X	107.950	142.083	15.875	LL521849C	LL521810
3.9370	5.9055	1.2598			4.2500	5.5938	.6250		
100.000	150.000	39.000	X33020	Y33020	107.950	146.050	21.432	L521949	L521910
3.9370	5.9055	1.5354			4.2500	5.7500	.8438		
100.000	180.000	37.000	X30220M	Y30220M	107.950	158.750	23.020	37425	37624
3.9370	7.0866	1.4567			4.2500	6.2500	.9063		
100.000	180.000	49.000	X32220M	Y32220M	107.950	159.987	34.925	LM522546	LM522510
3.9370	7.0866	1.9291			4.2500	6.2987	1.3750		
100.012	157.162	36.512	52393	52618	107.950	161.925	34.925	48190	48120
3.9375	6.1875	1.4375			4.2500	6.3750	1.3750		
100.813	180.975	47.625	789	772	107.950	165.100	36.512	56425	56650
3.9690	7.1250	1.8750			4.2500	6.5000	1.4375		
101.600	134.938	15.875	LL420549	LL420510	107.950	171.450	34.000	67425	67675
4.0000	5.3125	.6250			4.2500	6.7500	1.3386		
101.600	136.525	21.433	L420449	L420410	107.950	190.500	47.625	71425	71750
4.0000	5.3750	.8438			4.2500	7.5000	1.8750		
101.600	146.050	21.432	L521945	L521910	107.950	201.612	57.150	H424434	H424415
4.0000	5.7500	.8438			4.2500	7.9375	2.2500		
101.600	146.050	25.400	LM720648	LM720610	107.950	206.375	66.675	936	930
4.0000	5.7500	1.0000			4.2500	8.1250	2.6250		
101.600	146.050	31.750	LM120749	LM120710	107.950	212.725	66.674	HH224340	HH224310
4.0000	5.7500	1.2500			4.2500	8.3750	2.6250		
101.600	157.162	36.512	52400	52618	109.100	206.375	66.675	935A	930
4.0000	6.1875	1.4375			4.2953	8.1250	2.6250		
101.600	168.275	41.275	687	672	109.538	158.750	23.020	37431	37624
4.0000	6.6250	1.6250			4.3125	6.2500	.9063		

15

The Bearing Dimension Catalog is not to be used as a design manual.  
The cone bore section does not include all available parts – see series for additional information.

## BEARING DIMENSIONS BY CONE BORE

BORE d	OUTSIDE DIAMETER D	WIDTH T	CONE	CUP	BORE d	OUTSIDE DIAMETER D	WIDTH T	CONE	CUP
109.900 4.3268	212.725 8.3750	66.675 2.6250	937XA	932	114.976 4.5266	212.725 8.3750	66.674 2.6250	HH224349	HH224310
109.941 4.3284	195.262 7.6875	53.975 2.1250	HM124640	HM124618	115.000 4.5276	177.800 7.0000	40.000 1.5748	64452X	64700
109.952 4.3288	190.500 7.5000	47.625 1.8750	71432	71750	115.087 4.5310	190.500 7.5000	47.625 1.8750	71453	71750
109.974 4.3297	177.800 7.0000	41.275 1.6250	64432	64700	117.373 4.6210	195.262 7.6875	53.975 2.1250	HM124644	HM124618
109.984 4.3301	214.312 8.4375	55.562 2.1875	H924043	H924010	117.475 4.6250	179.974 7.0856	34.925 1.3750	68462	68709
109.987 4.3302	159.987 6.2987	34.925 1.3750	LM522548	LM522510	117.475 4.6250	212.725 8.3750	63.500 2.5000	H225148	H225110
109.992 4.3304	177.800 7.0000	41.275 1.6250	64433	64700	119.062 4.6875	195.262 7.6875	53.975 2.1250	HM124646	HM124618
110.000 4.3307	190.500 7.5000	47.625 1.8750	71433X	71750	119.949 4.7224	204.775 8.0620	55.563 2.1875	HM125943	HM125910
110.000 4.3307	206.375 8.1250	66.675 2.6250	942	930	119.957 4.7227	195.262 7.6875	53.975 2.1250	HM124649	HM124618
110.000 4.3307	170.000 6.6929	38.000 1.4961	X32022X	Y32022X	119.957 4.7227	207.962 8.1875	53.975 2.1250	HM127436	HM127415
110.000 4.3307	170.000 6.6929	47.000 1.8504	X33022	Y33022	119.964 4.7230	214.975 8.4636	47.625 1.8750	74472	74845
110.000 4.3307	200.000 7.8740	41.000 1.6142	X30222M	Y30222M	119.974 4.7234	172.242 6.7812	35.720 1.4063	M224748	M224713A
110.000 4.3307	200.000 7.8740	56.000 2.2047	X32222M	Y32222M	119.974 4.7234	254.000 10.0000	77.788 3.0625	HH228336	HH228310
110.332 4.3438	171.450 6.7500	34.000 1.3386	67434	67675	120.000 4.7244	214.975 8.4636	47.625 1.8750	74473X	74845
110.400 4.3465	146.000 5.7480	21.420 .8433	L522148VV	L522110V	120.000 4.7244	228.600 9.0000	53.975 2.1250	97472X	97900
111.125 4.3750	171.450 6.7500	34.000 1.3386	67437	67675	120.000 4.7244	165.000 6.4961	29.000 1.1417	X32924M	Y32924M
111.125 4.3750	177.800 7.0000	41.275 1.6250	64437	64700	120.000 4.7244	180.000 7.0866	38.000 1.4961	X32024X	Y32024X
111.125 4.3750	190.500 7.5000	47.625 1.8750	71437	71750	120.000 4.7244	180.000 7.0866	48.000 1.8898	X33024	Y33024
111.125 4.3750	214.312 8.4375	55.562 2.1875	H924045	H924010	120.000 4.7244	215.000 8.4646	43.500 1.7126	X30224M	Y30224M
111.918 4.4062	206.375 8.1250	66.675 2.6250	947	930	120.000 4.7244	215.000 8.4646	61.500 2.4213	X32224M	Y32224M
114.300 4.5000	152.400 6.0000	21.432 .8438	L623149	L623110	120.650 4.7500	160.338 6.3125	21.433 .8438	L624549	L624510
114.300 4.5000	158.750 6.2500	34.925 1.3750	LM122948	LM122911	120.650 4.7500	166.688 6.5625	25.400 1.0000	L724349	L724310
114.300 4.5000	161.925 6.3750	27.783 1.0938	LM722949	LM722910	120.650 4.7500	166.688 6.5625	52.387 2.0625	LM124448	LM124410
114.300 4.5000	177.800 7.0000	41.275 1.6250	64450	64700	120.650 4.7500	169.862 6.6875	25.400 1.0000	L225842	L225810
114.300 4.5000	179.974 7.0856	34.925 1.3750	68450	68709	120.650 4.7500	174.625 6.8750	35.720 1.4063	M224749	M224710
114.300 4.5000	190.500 7.5000	47.625 1.8750	71450	71750	120.650 4.7500	182.562 7.1875	39.689 1.5626	48282	48220
114.300 4.5000	201.612 7.9375	57.150 2.2500	H424442	H424415	120.650 4.7500	190.500 7.5000	46.037 1.8125	HM624749	HM624710
114.300 4.5000	206.375 8.1250	66.675 2.6250	938	930	120.650 4.7500	203.200 8.0000	46.038 1.8125	67384	67320
114.300 4.5000	212.725 8.3750	66.674 2.6250	HH224346	HH224310	120.650 4.7500	206.375 8.1250	47.625 1.8750	795	792
114.300 4.5000	228.600 9.0000	53.975 2.1250	HM926740	HM926710	120.650 4.7500	230.000 9.0551	63.500 2.5000	95475	95905
114.300 4.5000	228.600 9.0000	53.975 2.1250	97450	97900	120.650 4.7500	244.475 9.6250	57.150 2.2500	EE341048	341096
114.300 4.5000	254.000 10.0000	77.787 3.0625	EE197045	197100	120.650 4.7500	254.000 10.0000	77.788 3.0625	HH228340	HH228310
114.300 4.5000	273.050 10.7500	82.550 3.2500	HH926744	HH926710	120.650 4.7500	254.000 10.0000	77.788 3.0625	EE153044	153100
114.300 4.5000	279.400 11.0000	82.550 3.2500	EE514045	514110	120.650 4.7500	273.050 10.7500	82.550 3.2500	HH926749	HH926710
114.976 4.5266	177.800 7.0000	41.275 1.6250	64452	64700	123.825 4.8750	182.562 7.1875	39.689 1.5626	48286	48220

15

**BEARING DIMENSIONS BY CONE BORE**

BORE d	OUTSIDE DIAMETER D	WIDTH T	CONE	CUP	BORE d	OUTSIDE DIAMETER D	WIDTH T	CONE	CUP
123.825	204.775	55.563	HM125948	HM125910	127.792	228.600	53.975	97503	97900
4.8750	8.0620	2.1875			5.0312	9.0000	2.1250		
123.825	254.000	77.788	HH228344	HH228310	128.575	230.000	63.500	95506	95905
4.8750	10.0000	3.0625			5.0620	9.0551	2.5000		
123.825	254.000	77.788	EE153049	153100	128.587	190.500	34.925	48506	48750
4.8750	10.0000	3.0625			5.0625	7.5000	1.3750		
124.943	230.000	63.500	95491	95905	128.587	206.375	47.625	799	792
4.9190	9.0551	2.5000			5.0625	8.1250	1.8750		
125.298	228.600	53.975	HM926745	HM926710	129.967	207.962	53.975	HM127442	HM127415
4.9330	9.0000	2.1250			5.1168	8.1875	2.1250		
125.298	228.600	53.975	97493	97900	129.967	215.900	57.150	HM227545	HM227515
4.9330	9.0000	2.1250			5.1168	8.5000	2.2500		
126.987	207.962	53.975	HM127440	HM127415	129.967	230.000	63.500	95514X	95905
4.9995	8.1875	2.1250			5.1168	9.0551	2.5000		
127.000	165.895	18.257	LL225749	LL225710	129.974	230.000	63.500	95512	95905
5.0000	6.5313	.7188			5.1171	9.0551	2.5000		
127.000	169.862	25.400	L225849	L225810	129.974	254.000	79.502	HH228346NW	HH228310
5.0000	6.6875	1.0000			5.1171	10.0000	3.1300		
127.000	171.450	25.400	L725349	L725311	130.000	206.375	47.625	797	792
5.0000	6.7500	1.0000			5.1181	8.1250	1.8750		
127.000	173.038	42.863	M325948	M325911	130.000	214.975	47.625	74511X	74845
5.0000	6.8125	1.6875			5.1181	8.4636	1.8750		
127.000	174.625	36.512	LM125748	LM125711	130.000	230.000	63.500	95512X	95905
5.0000	6.8750	1.4375			5.1181	9.0551	2.5000		
127.000	182.562	39.689	48290	48220	130.000	262.000	78.000	EE154512	154103
5.0000	7.1875	1.5626			5.1181	10.3150	3.0709		
127.000	196.850	46.036	M327345	67322	130.000	200.000	45.000	X32026X	Y32026X
5.0000	7.7500	1.8125			5.1181	7.8740	1.7717		
127.000	203.200	46.038	67388	67320	130.000	230.000	43.750	X30226M	Y30226M
5.0000	8.0000	1.8125			5.1181	9.0551	1.7224		
127.000	206.375	47.625	796X	792	130.000	230.000	67.750	X32226M	Y32226M
5.0000	8.1250	1.8750			5.1181	9.0551	2.6673		
127.000	214.312	49.205	85499	85845	130.175	203.200	46.038	67389	67320
5.0000	8.4375	1.9372			5.1250	8.0000	1.8125		
127.000	214.975	47.625	74500	74845	130.175	206.375	47.625	799A	792
5.0000	8.4636	1.8750			5.1250	8.1250	1.8750		
127.000	215.900	57.150	HM227542	HM227515	131.750	207.962	53.975	HM127446	HM127415
5.0000	8.5000	2.2500			5.1870	8.1875	2.1250		
127.000	228.600	53.975	HM926747	HM926710	133.350	173.038	19.050	LL327049	LL327010
5.0000	9.0000	2.1250			5.2500	6.8125	.7500		
127.000	228.600	53.975	97500	97900	133.350	177.008	25.400	L327249	L327210
5.0000	9.0000	2.1250			5.2500	6.9688	1.0000		
127.000	230.000	63.500	95500	95905	133.350	184.150	25.400	L826949	L826914
5.0000	9.0551	2.5000			5.2500	7.2500	1.0000		
127.000	234.950	71.438	HH427346	HH427315	133.350	190.500	39.687	48385	48320
5.0000	9.2500	2.8125			5.2500	7.5000	1.5625		
127.000	247.650	63.500	EE116050	116097	133.350	194.975	35.300	LM229136C	LM229110
5.0000	9.7500	2.5000			5.2500	7.6762	1.3898		
127.000	249.974	66.675	99500	99097	133.350	196.850	46.036	M327349	67322
5.0000	9.8415	2.6250			5.2500	7.7500	1.8125		
127.000	254.000	77.788	HH228349	HH228310	133.350	203.200	46.038	67390	67320
5.0000	10.0000	3.0625			5.2500	8.0000	1.8125		
127.000	254.000	77.788	EE153050	153100	133.350	214.975	47.625	74525	74845
5.0000	10.0000	3.0625			5.2500	8.4636	1.8750		
127.000	279.400	82.550	EE514050	514110	133.350	230.000	63.500	95524V	95905
5.0000	11.0000	3.2500			5.2500	9.0551	2.5000		
127.000	285.000	85.003	EE455051	455112X	134.976	214.975	47.625	74529	74845
5.0000	11.2205	3.3466			5.3140	8.4636	1.8750		
127.000	288.925	82.550	HH231637	HH231610	136.525	187.325	28.575	LM328444	LM328410
5.0000	11.3750	3.2500			5.3750	7.3750	1.1250		
127.000	295.275	82.550	EE195500X	195116X	136.525	190.500	39.687	48393	48320
5.0000	11.6250	3.2500			5.3750	7.5000	1.5625		
127.000	295.275	82.553	EE540502	541162	136.525	194.975	33.000	LM229140C	LM229110
5.0000	11.6250	3.2501			5.3750	7.6762	1.2992		
127.000	304.800	60.325	750500	751200	136.525	214.975	47.625	74536W	74845
5.0000	12.0000	2.3750			5.3750	8.4636	1.8750		
127.000	304.800	88.900	HH932132	HH932110	136.525	228.600	57.150	896	892
5.0000	12.0000	3.5000			5.3750	9.0000	2.2500		
127.792	228.600	53.975	HM926749	HM926710	136.525	249.974	66.675	99537	99097
5.0312	9.0000	2.1250			5.3750	9.8415	2.6250		

The Bearing Dimension Catalog is not to be used as a design manual.  
The cone bore section does not include all available parts – see series for additional information.

**BEARING DIMENSIONS BY CONE BORE**

BORE d	OUTSIDE DIAMETER D	WIDTH T	CONE	CUP	BORE d	OUTSIDE DIAMETER D	WIDTH T	CONE	CUP
136.525 5.3750	280.000 11.0236	82.550 3.2500	EE270537XS	271102-S	144.462 5.6875	241.300 9.5000	63.500 2.5000	H230847	H230811
136.525 5.3750	304.800 12.0000	79.375 3.1250	EE580537	581200	146.050 5.7500	188.120 7.4063	22.225 .8750	LL529749	LL529710
137.318 5.4062	249.974 9.8415	66.675 2.6250	99540	99097	146.050 5.7500	193.675 7.6250	28.575 1.1250	36690	36620
139.687 5.4995	269.875 10.6250	77.000 3.0315	H432640	H432610	146.050 5.7500	203.200 8.0000	45.100 1.7756	M229349	M229310
139.700 5.5000	180.975 7.1250	21.432 .8438	LL428349	LL428310	146.050 5.7500	236.538 9.3125	57.150 2.2500	HM231140	HM231110
139.700 5.5000	187.325 7.3750	28.575 1.1250	LM328448	LM328410	146.050 5.7500	236.538 9.3125	57.150 2.2500	82576	82931
139.700 5.5000	188.912 7.4375	39.688 1.5625	LM328048	LM328011	146.050 5.7500	244.475 9.6250	47.625 1.8750	81575	81962
139.700 5.5000	214.975 8.4636	47.625 1.8750	74550	74845	146.050 5.7500	249.974 9.8415	66.675 2.6250	99575	99097
139.700 5.5000	222.250 8.7500	34.925 1.3750	73551	73875	146.050 5.7500	268.288 10.5625	74.613 2.9375	EE107057	107105
139.700 5.5000	228.600 9.0000	57.150 2.2500	898	892	146.050 5.7500	285.750 11.2500	76.200 3.0000	EE217056	217112
139.700 5.5000	236.538 9.3125	57.150 2.2500	HM231132	HM231110	146.050 5.7500	304.800 12.0000	60.325 2.3750	EE750573	751200
139.700 5.5000	236.538 9.3125	57.150 2.2500	82550	82931	146.050 5.7500	304.800 12.0000	88.900 3.5000	HH932145	HH932110
139.700 5.5000	241.300 9.5000	63.500 2.5000	H230844	H230811	146.050 5.7500	307.975 12.1250	88.900 3.5000	HH234040	HH234010
139.700 5.5000	246.858 9.7188	60.325 2.3750	H429648	H429611	149.225 5.8750	236.538 9.3125	57.150 2.2500	HM231148	HM231110
139.700 5.5000	249.974 9.8415	66.675 2.6250	99550	99097	149.225 5.8750	236.538 9.3125	57.150 2.2500	82587	82931
139.700 5.5000	268.288 10.5625	74.613 2.9375	EE107055	107105	149.225 5.8750	249.974 9.8415	66.675 2.6250	99587	99097
139.700 5.5000	288.925 11.3750	82.550 3.2500	HH231649	HH231610	149.860 5.9000	317.500 12.5000	77.787 3.0625	560990	561251
139.700 5.5000	295.275 11.6250	82.553 3.2501	EE540550	541162	149.967 5.9042	252.412 9.9375	63.500 2.5000	HM133436	HM133416
139.700 5.5000	304.800 12.0000	60.325 2.3750	750550	751200	149.974 5.9045	249.974 9.8415	66.675 2.6250	99591	99097
139.700 5.5000	307.975 12.1250	88.900 3.5000	HH234031	HH234010	149.987 5.9050	223.838 8.8125	46.037 1.8125	M432144	M432111
139.878 5.5070	285.000 11.2205	85.003 3.3466	455958	455112X	150.000 5.9055	244.475 9.6250	47.625 1.8750	81590	81962
139.974 5.5108	214.975 8.4636	47.625 1.8750	74556	74845	150.000 5.9055	249.974 9.8415	66.675 2.6250	99590X	99097
139.974 5.5108	249.974 9.8415	66.675 2.6250	99553	99097	150.000 5.9055	210.000 8.2677	38.000 1.4961	X32930M	Y32930M
140.000 5.5118	214.975 8.4636	47.625 1.8750	74551X	74845	150.000 5.9055	225.000 8.8583	48.000 1.8898	X32030X	YX
140.000 5.5118	285.000 11.2205	85.003 3.3466	EE455055X	455112X	150.000 5.9055	270.000 10.6299	49.000 1.9291	X30230M	Y30230M
140.000 5.5118	190.000 7.4803	32.000 1.2598	X32928M	Y32928M	150.698 5.9330	317.500 12.5000	77.787 3.0625	EE560592	561251
140.000 5.5118	210.000 8.2677	45.000 1.7717	X32028X	Y32028X	150.812 5.9375	203.200 8.0000	41.275 1.6250	LM330446	LM330410
140.000 5.5118	250.000 9.8425	45.750 1.8012	X30228M	Y30228M	150.812 5.9375	244.475 9.6250	47.625 1.8750	81593	81962
142.875 5.6250	193.675 7.6250	28.575 1.1250	36686	36620	150.967 5.9436	222.250 8.7500	46.830 1.8437	M231647	M231610
142.875 5.6250	194.975 7.6762	33.000 1.2992	LM229147C	LM229110	152.387 5.9995	269.875 10.6250	77.000 3.0315	H432649	H432610
142.875 5.6250	200.025 7.8750	41.275 1.6250	48684	48620	152.400 6.0000	192.088 7.5625	25.000 .9843	L630349	L630310
142.875 5.6250	222.250 8.7500	34.925 1.3750	73562	73875	152.400 6.0000	203.200 8.0000	28.575 1.1250	L730649	L730610
142.875 5.6250	236.538 9.3125	57.150 2.2500	HM231136	HM231110	152.400 6.0000	203.200 8.0000	41.275 1.6250	LM330448	LM330410
142.875 5.6250	236.538 9.3125	57.150 2.2500	82562	82931	152.400 6.0000	222.250 8.7500	46.830 1.8437	M231648	M231610
144.450 5.6870	252.412 9.9375	63.500 2.5000	HM133432	HM133416	152.400 6.0000	244.475 9.6250	47.625 1.8750	81600	81962

**15**



**BEARING DIMENSIONS BY CONE BORE**

BORE d	OUTSIDE DIAMETER D	WIDTH T	CONE	CUP	BORE d	OUTSIDE DIAMETER D	WIDTH T	CONE	CUP
152.400	249.974	66.675	99600	99097	165.100	288.925	63.500	94649	94113
6.0000	9.8415	2.6250			6.5000	11.3750	2.5000		
152.400	266.700	66.675	HM234636	HM234610	165.100	288.925	63.500	HM237534	HM237510
6.0000	10.5000	2.6250			6.5000	11.3750	2.5000		
152.400	268.288	74.613	EE107060	107105	165.100	298.450	82.550	EE219065	219117
6.0000	10.5625	2.9375			6.5000	11.7500	3.2500		
152.400	285.750	76.200	EE217060	217112	165.100	311.150	82.550	H238140	H238110
6.0000	11.2500	3.0000			6.5000	12.2500	3.2500		
152.400	304.800	79.375	580995	581200	165.100	317.500	77.787	EE560650	561251
6.0000	12.0000	3.1250			6.5000	12.5000	3.0625		
152.400	307.975	88.900	HH234048	HH234010	165.100	336.550	79.375	EE590649	591326
6.0000	12.1250	3.5000			6.5000	13.2500	3.1250		
152.400	317.500	77.787	EE560600	561251	165.100	336.550	88.900	EE717065	717132
6.0000	12.5000	3.0625			6.5000	13.2500	3.5000		
152.400	355.600	61.909	780600	781400	165.100	336.550	92.075	HH437549	HH437510
6.0000	14.0000	2.4374			6.5000	13.2500	3.6250		
153.988	244.475	47.625	81606	81962	165.100	355.600	61.909	780650	781400
6.0625	9.6250	1.8750			6.5000	14.0000	2.4374		
155.575	330.200	85.725	H936340	H936310	165.100	360.000	92.075	EE420651	421417
6.1250	13.0000	3.3750			6.5000	14.1732	3.6250		
157.150	252.412	63.500	HM133444	HM133416	165.100	361.950	106.362	EE108065	108142
6.1870	9.9375	2.5000			6.5000	14.2500	4.1875		
157.162	223.838	46.037	M432148A	M432111	166.000	225.425	41.275	46791A	46720
6.1875	8.8125	1.8125			6.5354	8.8750	1.6250		
158.750	205.582	23.812	L432348	L432310	166.688	225.425	41.275	46792	46720
6.2500	8.0938	.9375			6.5625	8.8750	1.6250		
158.750	225.425	41.275	46780	46720	167.945	254.000	49.212	M235146AX	M235113
6.2500	8.8750	1.6250			6.6120	10.0000	1.9375		
158.750	285.750	76.200	EE217062X	217112	168.275	247.650	47.625	67782	67720
6.2500	11.2500	3.0000			6.6250	9.7500	1.8750		
158.750	304.800	66.675	EE280626	281200	168.275	254.000	46.037	M235146	M235113
6.2500	12.0000	2.6250			6.6250	10.0000	1.8125		
159.512	266.700	66.675	HM234643	HM234610	168.275	330.200	85.725	H936348XX	H936310
6.2800	10.5000	2.6250			6.6250	13.0000	3.3750		
159.918	317.500	77.787	EE560629	561251	168.326	254.000	49.212	M235146X	M235113
6.2960	12.5000	3.0625			6.6270	10.0000	1.9375		
159.951	244.475	47.625	81629	81962	169.974	260.350	66.675	HM535347	HM535310
6.2973	9.6250	1.8750			6.6919	10.2500	2.6250		
160.000	252.412	63.500	HM133448	HM133416	169.984	288.925	63.500	94669	94113
6.2992	9.9375	2.5000			6.6923	11.3750	2.5000		
160.000	240.000	51.000	X32032XM	Y32032XM	170.000	254.000	46.037	M235149	M235113
6.2992	9.4488	2.0079			6.6929	10.0000	1.8125		
160.325	288.925	63.500	HM237532	HM237510	170.000	254.000	46.038	86669	86100
6.3120	11.3750	2.5000			6.6929	10.0000	1.8125		
160.338	317.500	77.787	EE560631X	561251	170.000	230.000	38.000	X32934M	Y32934M
6.3125	12.5000	3.0625			6.6929	9.0551	1.4961		
161.925	244.475	47.625	81637	81962	170.000	260.000	57.000	X32034XM	Y32034XM
6.3750	9.6250	1.8750			6.6929	10.2362	2.2441		
161.925	336.550	79.375	EE590638	591326	171.450	222.250	25.400	L435049	L435010
6.3750	13.2500	3.1250			6.7500	8.7500	1.0000		
161.925	374.650	87.312	EE117063	117148	171.450	254.000	46.038	86675	86100
6.3750	14.7500	3.4375			6.7500	10.0000	1.8125		
164.976	288.925	63.500	HM237537	HM237510	171.450	260.350	66.675	HM535349	HM535310
6.4951	11.3750	2.5000			6.7500	10.2500	2.6250		
165.100	215.900	26.195	L433749	L433710	171.450	288.925	63.500	94675	94113
6.5000	8.5000	1.0313			6.7500	11.3750	2.5000		
165.100	225.425	41.275	46790	46720	171.450	288.925	63.500	HM237540	HM237510
6.5000	8.8750	1.6250			6.7500	11.3750	2.5000		
165.100	231.976	45.000	M533349-S	M533310	171.450	336.550	79.375	EE590675	591326
6.5000	9.1329	1.7717			6.7500	13.2500	3.1250		
165.100	247.650	47.625	67780	67720	171.450	355.600	61.909	EE780676	781400
6.5000	9.7500	1.8750			6.7500	14.0000	2.4374		
165.100	254.000	46.037	M235145	M235113	171.450	374.650	87.312	EE117067	117148
6.5000	10.0000	1.8125			6.7500	14.7500	3.4375		
165.100	254.000	46.038	86650	86100	174.625	247.650	47.625	67786	67720
6.5000	10.0000	1.8125			6.8750	9.7500	1.8750		
165.100	260.350	53.975	HM235148	HM235118	174.625	260.350	53.975	M236845	M236810
6.5000	10.2500	2.1250			6.8750	10.2500	2.1250		
165.100	266.700	66.675	HM234648	HM234610	174.625	288.925	63.500	94687	94113
6.5000	10.5000	2.6250			6.8750	11.3750	2.5000		

The Bearing Dimension Catalog is not to be used as a design manual.  
The cone bore section does not include all available parts – see series for additional information.

## BEARING DIMENSIONS BY CONE BORE

BORE d	OUTSIDE DIAMETER D	WIDTH T	CONE	CUP	BORE d	OUTSIDE DIAMETER D	WIDTH T	CONE	CUP
174.625 6.8750	288.925 11.3750	63.500 2.5000	HM237542	HM237510	183.000 7.2047	304.800 12.0000	66.675 2.6250	EE280720X	281200
174.625 6.8750	298.450 11.7500	82.550 3.2500	EE219068	219117	184.150 7.2500	234.950 9.2500	34.000 1.3386	LM236749	LM236710
174.625 6.8750	311.150 12.2500	82.550 3.2500	H238148	H238110	184.150 7.2500	236.538 9.3125	26.193 1.0312	LL537649	LL537610
174.625 6.8750	355.600 14.0000	61.909 2.4374	780687	781400	184.150 7.2500	266.700 10.5000	47.625 1.8750	67883	67820
176.212 6.9375	355.600 14.0000	61.909 2.4374	780693	781400	187.325 7.3750	266.700 10.5000	47.625 1.8750	67884	67820
177.292 6.9800	355.600 14.0000	79.375 3.1250	EE607071	607140	187.325 7.3750	269.875 10.6250	55.563 2.1875	M238849	M238810
177.800 7.0000	215.900 8.5000	20.638 .8125	LL735448	LL735410	187.325 7.3750	282.575 11.1250	50.800 2.0000	87737	87111
177.800 7.0000	227.012 8.9375	30.163 1.1875	36990	36920	187.325 7.3750	319.964 12.5970	88.900 3.5000	H239649	H239610
177.800 7.0000	247.650 9.7500	47.625 1.8750	67790	67720	187.630 7.3870	279.400 11.0000	52.387 2.0625	M239441	M239410
177.800 7.0000	260.350 10.2500	53.975 2.1250	M236848	M236810	189.738 7.4700	279.400 11.0000	52.387 2.0625	M239447	M239410
177.800 7.0000	265.112 10.4375	51.595 2.0313	M336946	M336912	190.000 7.4803	290.000 11.4173	64.000 2.5197	X32038XM	Y32038XM
177.800 7.0000	269.875 10.6250	55.563 2.1875	M238840	M238810	190.078 7.4834	266.700 10.5000	47.100 1.8543	67886	67820
177.800 7.0000	279.400 11.0000	61.913 2.4375	82680X	82620	190.475 7.4990	279.400 11.0000	52.387 2.0625	M239449	M239410
177.800 7.0000	285.750 11.2500	63.500 2.5000	EE91702	91112	190.500 7.5000	266.700 10.5000	47.625 1.8750	67885	67820
177.800 7.0000	288.925 11.3750	63.500 2.5000	94700	94113	190.500 7.5000	282.575 11.1250	50.800 2.0000	87750	87111
177.800 7.0000	288.925 11.3750	63.500 2.5000	HM237543	HM237510	190.500 7.5000	288.925 11.3750	55.562 2.1875	82788	82720
177.800 7.0000	304.800 12.0000	66.675 2.6250	EE280702	281200	190.500 7.5000	317.500 12.5000	63.500 2.5000	93750	93125
177.800 7.0000	311.150 12.2500	82.550 3.2500	H238147	H238110	190.500 7.5000	327.025 12.8750	90.487 3.5625	EE470075	470128
177.800 7.0000	319.964 12.5970	88.900 3.5000	EE222070	222126	190.500 7.5000	330.200 13.0000	63.500 2.5000	EE210753	211300
177.800 7.0000	319.964 12.5970	88.900 3.5000	H239640	H239610	190.500 7.5000	336.550 13.2500	98.425 3.8750	HH840249	HH840210
177.800 7.0000	327.025 12.8750	90.487 3.5625	EE470073	470128	190.500 7.5000	355.600 14.0000	79.375 3.1250	EE607075	607140
177.800 7.0000	336.550 13.2500	79.375 3.1250	590900	591326	190.500 7.5000	360.000 14.1732	92.075 3.6250	EE420751	421417
177.800 7.0000	355.600 14.0000	61.909 2.4374	780700	781400	190.500 7.5000	428.625 16.8750	106.362 4.1875	EE350750	351687
177.800 7.0000	355.600 14.0000	79.375 3.1250	EE607070	607140	191.237 7.5290	279.400 11.0000	53.975 2.1250	M239448A	M239410
177.800 7.0000	360.000 14.1732	92.075 3.6250	EE420701	421417	192.088 7.5625	266.700 10.5000	47.625 1.8750	67887	67820
177.800 7.0000	428.625 16.8750	106.362 4.1875	EE350701	351687	193.675 7.6250	282.575 11.1250	50.800 2.0000	87762	87111
178.595 7.0313	265.112 10.4375	51.595 2.0313	M336948	M336912	194.976 7.6762	266.700 10.5000	47.625 1.8750	67888	67820
179.388 7.0625	265.112 10.4375	54.770 2.1563	M336949A	M336912	196.850 7.7500	241.300 9.5000	23.813 .9375	LL639249	LL639210
179.934 7.0840	265.112 10.4375	51.595 2.0313	M336949	M336912	196.850 7.7500	254.000 10.0000	28.575 1.1250	L540049	L540010
179.954 7.0848	288.925 11.3750	62.062 2.4434	HM237546	HM237510	196.850 7.7500	257.175 10.1250	39.688 1.5625	LM739749WE	LM739710
179.974 7.0856	317.500 12.5000	63.500 2.5000	93708	93125	196.850 7.7500	317.500 12.5000	63.500 2.5000	93775	93125
180.000 7.0866	266.700 10.5000	47.100 1.8543	67875	67820	198.298 7.8070	279.400 11.0000	46.038 1.8125	67981	67919
180.000 7.0866	288.925 11.3750	63.500 2.5000	HM237547	HM237510	199.949 7.8720	279.400 11.0000	46.038 1.8125	67982	67919
180.000 7.0866	250.000 9.8425	45.000 1.7717	X32936M	Y32936M	199.974 7.8730	317.500 12.5000	66.675 2.6250	122978	122125
180.000 7.0866	280.000 11.0236	64.000 2.5197	X32036XM	Y32036XM	200.000 7.8740	254.000 10.0000	28.575 1.1250	L540048	L540010

BEARING DIMENSIONS BY CONE BORE

BORE d	OUTSIDE DIAMETER D	WIDTH T	CONE	CUP	BORE d	OUTSIDE DIAMETER D	WIDTH T	CONE	CUP
200.000	280.000	51.000	X32940M	Y32940M	209.550	279.400	46.038	67989	67919
7.8740	11.0236	2.0079			8.2500	11.0000	1.8125		
200.000	310.000	70.000	X32040X	Y32040X	209.550	317.500	63.500	93825	93125
7.8740	12.2047	2.7559			8.2500	12.5000	2.5000		
200.025	276.225	42.863	LM241147	LM241110	209.550	333.375	69.850	HM743345	HM743310
7.8750	10.8750	1.6875			8.2500	13.1250	2.7500		
200.025	292.100	57.945	M241542	M241510	209.550	355.600	68.262	96825	96140
7.8750	11.5000	2.2813			8.2500	14.0000	2.6875		
200.025	317.500	63.500	93787	93125	212.725	285.750	46.037	LM742745	LM742710
7.8750	12.5000	2.5000			8.3750	11.2500	1.8125		
200.025	333.375	69.850	HM743337	HM743310	212.725	336.550	65.087	M246932	M246910
7.8750	13.1250	2.7500			8.3750	13.2500	2.5625		
200.025	355.600	69.850	EE130787	131400	215.900	285.750	46.037	LM742748	LM742710
7.8750	14.0000	2.7500			8.5000	11.2500	1.8125		
200.025	384.175	112.712	H247535	H247510	215.900	290.010	31.750	543085	543114
7.8750	15.1250	4.4375			8.5000	11.4177	1.2500		
200.025	393.700	111.125	HH144642	HH144614	215.900	355.600	69.850	EE130851	131400
7.8750	15.5000	4.3750			8.5000	14.0000	2.7500		
200.812	292.100	57.945	M241545	M241510	215.900	360.000	82.550	EE420850	421417
7.9060	11.5000	2.2813			8.5000	14.1732	3.2500		
201.612	360.000	92.075	EE420793	421417	216.408	285.750	46.037	LM742747	LM742710
7.9375	14.1732	3.6250			8.5200	11.2500	1.8125		
203.200	261.142	28.575	LL641149	LL641110	216.713	285.750	46.037	LM742747A	LM742710
8.0000	10.2812	1.1250			8.5320	11.2500	1.8125		
203.200	276.225	42.863	LM241149	LM241110	219.916	399.928	72.000	EE710865	711574
8.0000	10.8750	1.6875			8.6581	15.7452	2.8347		
203.200	279.400	46.038	67983	67919	219.969	290.010	31.750	543086	543114
8.0000	11.0000	1.8125			8.6602	11.4177	1.2500		
203.200	292.100	57.945	M241547	M241510	220.000	300.000	51.000	X32944	Y32944
8.0000	11.5000	2.2813			8.6614	11.8110	2.0079		
203.200	317.500	53.975	EE132083	132125	220.000	340.000	76.000	X32044X	Y32044X
8.0000	12.5000	2.1250			8.6614	13.3858	2.9921		
203.200	317.500	63.500	93800	93125	220.662	314.325	61.912	M244249	M244210
8.0000	12.5000	2.5000			8.6875	12.3750	2.4375		
203.200	317.500	66.675	EE122080	122125	220.878	317.500	47.625	LM245833	LM245810
8.0000	12.5000	2.6250			8.6960	12.5000	1.8750		
203.200	346.075	79.375	HM542948	HM542911	222.250	482.600	117.475	EE380875	380190
8.0000	13.6250	3.1250			8.7500	19.0000	4.6250		
203.200	360.000	92.075	EE420801	421417	223.838	295.275	46.038	LM844049	LM844010
8.0000	14.1732	3.6250			8.8125	11.6250	1.8125		
203.200	399.928	72.000	710800	711574	225.425	355.600	69.850	EE130889	131400
8.0000	15.7452	2.8347			8.8750	14.0000	2.7500		
203.200	406.400	92.075	EE114080	114160	225.425	400.050	88.900	EE430888	431575
8.0000	16.0000	3.6250			8.8750	15.7500	3.5000		
203.200	482.600	117.475	EE380080	380190	227.330	399.928	72.000	EE710905	711574
8.0000	19.0000	4.6250			8.9500	15.7452	2.8347		
203.238	406.400	92.075	EE114081	114160	228.397	431.800	92.075	EE113089	113170
8.0015	16.0000	3.6250			8.9920	17.0000	3.6250		
203.479	261.142	28.575	LL641148	LL641110	228.460	431.800	92.075	EE113091	113170
8.0110	10.2812	1.1250			8.9945	17.0000	3.6250		
203.987	276.225	42.863	LM241148	LM241110	228.600	295.275	33.337	544090	544116
8.0310	10.8750	1.6875			9.0000	11.6250	1.3125		
204.788	292.100	57.945	M241549	M241510	228.600	320.675	50.800	88900	88126
8.0625	11.5000	2.2813			9.0000	12.6250	2.0000		
204.788	317.500	63.500	93806A	93125	228.600	327.025	52.388	8573	8520
8.0625	12.5000	2.5000			9.0000	12.8750	2.0625		
206.375	261.142	28.575	LL641149A	LL641110	228.600	355.600	68.262	96900	96140
8.1250	10.2812	1.1250			9.0000	14.0000	2.6875		
206.375	279.400	46.038	67985	67919	228.600	355.600	69.850	HM746645	HM746610
8.1250	11.0000	1.8125			9.0000	14.0000	2.7500		
206.375	317.500	53.975	EE132084	132125	228.600	355.600	69.850	EE130902	131400
8.1250	12.5000	2.1250			9.0000	14.0000	2.7500		
206.375	317.500	63.500	93812	93125	228.600	358.775	71.437	M249732	M249710
8.1250	12.5000	2.5000			9.0000	14.1250	2.8125		
206.375	336.550	98.425	H242649	H242610	228.600	399.928	72.000	710900	711574
8.1250	13.2500	3.8750			9.0000	15.7452	2.8347		
206.375	360.000	92.075	EE420812X	421417	228.600	400.050	88.900	EE430900	431575
8.1250	14.1732	3.6250			9.0000	15.7500	3.5000		
206.375	482.600	117.475	EE380081	380190	228.600	425.450	101.600	EE700091	700167
8.1250	19.0000	4.6250			9.0000	16.7500	4.0000		

The Bearing Dimension Catalog is not to be used as a design manual.  
The cone bore section does not include all available parts – see series for additional information.

# BEARING DIMENSIONS BY CONE BORE

BORE d	OUTSIDE DIAMETER D	WIDTH T	CONE	CUP	BORE d	OUTSIDE DIAMETER D	WIDTH T	CONE	CUP
228.600 9.0000	488.950 19.2500	123.825 4.8750	HH949549	HH949510	247.650 9.7500	304.800 12.0000	22.225 .8750	28880	28820
228.600 9.0000	508.000 20.0000	117.475 4.6250	EE390090	390200	247.650 9.7500	346.075 13.6250	63.500 2.5000	M348448WS	M348410
230.188 9.0625	317.500 12.5000	47.625 1.8750	LM245846	LM245810	247.650 9.7500	355.600 14.0000	50.800 2.0000	EE170975	171400
231.775 9.1250	268.288 10.5625	22.500 .8858	LL244549	LL244510	247.650 9.7500	381.000 15.0000	74.612 2.9375	M252337	M252310
231.775 9.1250	295.275 11.6250	33.337 1.3125	544091	544116	247.650 9.7500	406.400 16.0000	115.888 4.5625	HH249949	HH249910
231.775 9.1250	317.500 12.5000	47.625 1.8750	LM245848	LM245810	249.250 9.8130	381.000 15.0000	79.375 3.1250	EE126098	126150
231.775 9.1250	336.550 13.2500	65.087 2.5625	M246942	M246910	253.975 9.9990	324.950 12.7933	39.000 1.5354	L848848XX	L848810
231.775 9.1250	358.775 14.1250	71.437 2.8125	M249734	M249710	254.000 10.0000	315.912 12.4375	31.750 1.2500	LL648448W	LL648415
231.775 9.1250	377.825 14.8750	79.375 3.1250	HM647448	HM647411	254.000 10.0000	323.850 12.7500	22.224 .8750	29875	29820
231.775 9.1250	384.175 15.1250	112.712 4.4375	H247545WS	H247510	254.000 10.0000	358.775 14.1250	71.437 2.8125	M249749	M249710
234.848 9.2460	314.325 12.3750	49.212 1.9375	LM545848	LM545810	254.000 10.0000	365.125 14.3750	58.738 2.3125	EE134100	134143
234.950 9.2500	311.150 12.2500	46.037 1.8125	LM446349	LM446310	254.000 10.0000	393.700 15.5000	73.817 2.9062	EE275100	275155
234.950 9.2500	314.325 12.3750	49.212 1.9375	LM545849	LM545810	254.000 10.0000	400.050 15.7500	57.150 2.2500	EE251001	251575
234.950 9.2500	320.675 12.6250	50.800 2.0000	88925	88126	254.000 10.0000	422.275 16.6250	86.121 3.3906	HM252343	HM252310
234.950 9.2500	327.025 12.8750	52.388 2.0625	8574	8520	254.000 10.0000	444.500 17.5000	76.200 3.0000	EE822100	822175
234.950 9.2500	355.600 14.0000	68.262 2.6875	96925	96140	254.000 10.0000	495.300 19.5000	76.200 3.0000	EE941002	941950
234.950 9.2500	381.000 15.0000	74.612 2.9375	M252330	M252310	254.000 10.0000	495.300 19.5000	141.287 5.5625	HH258232	HH258210
234.950 9.2500	384.175 15.1250	112.712 4.4375	H247548	H247510	254.000 10.0000	533.400 21.0000	133.350 5.2500	HH953749	HH953710
235.077 9.2550	314.325 12.3750	49.212 1.9375	LM545847	LM545810	254.000 10.0000	558.800 22.0000	123.825 4.8750	EE620100	620220
235.331 9.2650	336.550 13.2500	65.087 2.5625	M246947	M246910	255.600 10.0630	342.900 13.5000	57.150 2.2500	M349546XX	M349510
236.538 9.3125	320.675 12.6250	44.450 1.7500	88931	88126	257.175 10.1250	342.900 13.5000	57.150 2.2500	M349549	M349510
237.330 9.3437	336.550 13.2500	65.087 2.5625	M246948	M246910	257.175 10.1250	358.775 14.1250	71.437 2.8125	M249747	M249710
237.330 9.3437	358.775 14.1250	71.437 2.8125	M249736	M249710	258.763 10.1875	400.050 15.7500	69.850 2.7500	EE221018	221575
240.000 9.4488	360.000 14.1732	76.000 2.9921	X32048X	Y32048X	260.350 10.2500	365.125 14.3750	58.738 2.3125	EE134102	134143
241.122 9.4930	368.300 14.5000	68.262 2.6875	EE125094	125145	260.350 10.2500	400.050 15.7500	69.850 2.7500	EE221026	221575
241.300 9.5000	327.025 12.8750	52.388 2.0625	8578	8520	260.350 10.2500	406.400 16.0000	69.850 2.7500	EE128102	128160
241.300 9.5000	349.148 13.7460	57.150 2.2500	EE127095	127135	260.350 10.2500	419.100 16.5000	85.725 3.3750	EE435102	435165
241.300 9.5000	355.600 14.0000	50.800 2.0000	EE170950	171400	260.350 10.2500	422.275 16.6250	86.121 3.3906	HM252348	HM252310
241.300 9.5000	368.300 14.5000	68.262 2.6875	EE125095	125145	260.350 10.2500	488.950 19.2500	120.650 4.7500	EE295102	295193
241.300 9.5000	393.700 15.5000	73.817 2.9062	EE275095	275155	262.974 10.3533	355.600 14.0000	57.150 2.2500	LM451344	LM451310
241.300 9.5000	444.500 17.5000	101.600 4.0000	EE923095	923175	263.525 10.3750	325.438 12.8125	28.575 1.1250	38880	38820
241.300 9.5000	488.950 19.2500	120.650 4.7500	EE295950	295193	263.525 10.3750	355.600 14.0000	57.150 2.2500	LM451345	LM451310
241.300 9.5000	508.000 20.0000	117.475 4.6250	EE390095	390200	264.975 10.4321	352.425 13.8750	36.513 1.4375	L853042	L853010
243.682 9.5938	315.912 12.4375	31.750 1.2500	LL648434	LL648415	264.975 10.4321	355.600 14.0000	57.150 2.2500	LM451347	LM451310
244.475 9.6250	381.000 15.0000	79.375 3.1250	EE126097	126150	266.560 10.4945	325.438 12.8125	29.500 1.1614	38884	38820

15

BEARING DIMENSIONS BY CONE BORE

BORE d	OUTSIDE DIAMETER D	WIDTH T	CONE	CUP	BORE d	OUTSIDE DIAMETER D	WIDTH T	CONE	CUP
266.560	325.438	29.500	LL450748A	38820	298.450	431.800	69.850	EE111175	111700
10.4945	12.8125	1.1614			11.7500	17.0000	2.7500		
266.700	323.850	22.224	29880	29820	298.450	444.500	63.500	EE291175	291749
10.5000	12.7500	.8750			11.7500	17.5000	2.5000		
266.700	325.438	28.575	38885	38820	299.974	495.300	141.287	HH258248	HH258210
10.5000	12.8125	1.1250			11.8100	19.5000	5.5625		
266.700	325.438	29.500	LL450749	38820	300.000	420.000	76.000	X32960	Y32960
10.5000	12.8125	1.1614			11.8110	16.5354	2.9921		
266.700	355.600	57.150	LM451349	LM451310	300.038	422.275	82.550	HM256849	HM256810
10.5000	14.0000	2.2500			11.8125	16.6250	3.2500		
266.700	393.700	73.817	EE275105	275155	304.800	393.700	50.800	L357049	L357010
10.5000	15.5000	2.9062			12.0000	15.5000	2.0000		
266.700	444.500	120.650	H852849	H852810	304.800	406.400	63.500	LM757049	LM757010
10.5000	17.5000	4.7500			12.0000	16.0000	2.5000		
269.875	381.000	74.612	M252349	M252310	304.800	438.048	76.200	EE129120X	129172
10.6250	15.0000	2.9375			12.0000	17.2460	3.0000		
273.050	323.850	22.224	29888	29820	304.800	444.500	63.500	EE291201	291749
10.7500	12.7500	.8750			12.0000	17.5000	2.5000		
273.050	393.700	73.817	EE275108	275155	304.800	488.950	92.075	EE724119	724191
10.7500	15.5000	2.9062			12.0000	19.2500	3.6250		
275.000	352.425	36.513	L853048	L853010	304.800	495.300	76.200	EE941205	941950
10.8268	13.8750	1.4375			12.0000	19.5000	3.0000		
276.225	352.425	36.513	L853049	L853010	304.800	499.948	101.600	M959442	M959410
10.8750	13.8750	1.4375			12.0000	19.6830	4.0000		
279.400	317.500	22.860	LL352148	LL352110	304.800	546.100	159.128	HH159849E	HH159810
11.0000	12.5000	.9000			12.0000	21.5000	6.2649		
279.400	374.650	47.625	L555233	L555210	304.800	558.800	136.525	EE790120	790221
11.0000	14.7500	1.8750			12.0000	22.0000	5.3750		
279.400	469.900	95.250	EE722110	722185	304.800	647.700	139.700	EE991201	992550
11.0000	18.5000	3.7500			12.0000	25.5000	5.5000		
279.400	488.950	120.650	EE295110	295193	305.054	406.400	63.500	LM757049A	LM757010
11.0000	19.2500	4.7500			12.0100	16.0000	2.5000		
279.400	520.700	120.650	EE296110	296204	312.738	358.775	22.225	LL957049	LL957010
11.0000	20.5000	4.7500			12.3125	14.1250	.8750		
279.982	380.898	65.088	LM654642	LM654610	314.325	447.675	85.725	HM259047WS	HM259010
11.0229	14.9960	2.5625			12.3750	17.6250	3.3750		
280.000	406.400	69.850	EE128112	128160	314.325	495.300	120.650	H859049	H859010
11.0236	16.0000	2.7500			12.3750	19.5000	4.7500		
280.192	400.050	52.387	EE101103	101575	317.500	444.500	63.500	EE291250	291749
11.0312	15.7500	2.0625			12.5000	17.5000	2.5000		
280.192	406.400	69.850	EE128110	128160	317.500	447.675	85.725	HM259048	HM259010
11.0312	16.0000	2.7500			12.5000	17.6250	3.3750		
282.575	393.700	63.500	84111W	84155	317.500	457.200	66.675	EE201250	201800
11.1250	15.5000	2.5000			12.5000	18.0000	2.6250		
285.750	323.850	20.638	LL353249	LL353210	317.500	596.900	136.525	EE720125	720236
11.2500	12.7500	.8125			12.5000	23.5000	5.3750		
285.750	354.012	33.337	545112	545139	317.500	622.300	147.638	H961649	H961610
11.2500	13.9375	1.3125			12.5000	24.5000	5.8125		
285.750	380.898	65.088	LM654649	LM654610	317.500	647.700	139.700	EE991251	992550
11.2500	14.9960	2.5625			12.5000	25.5000	5.5000		
285.750	469.900	81.770	EE921124	921850	320.000	480.000	100.000	X32064X	Y32064X
11.2500	18.5000	3.2193			12.5984	18.8976	3.9370		
285.750	520.700	120.650	EE296112	296204	320.675	406.400	50.800	L558548	L558510
11.2500	20.5000	4.7500			12.6250	16.0000	2.0000		
288.925	406.400	77.787	M255448	M255410	320.675	546.100	114.300	EE298128	298216
11.3750	16.0000	3.0625			12.6250	21.5000	4.5000		
289.974	393.700	50.800	L357040	L357010	323.850	381.000	28.575	LL758744	LL758715
11.4163	15.5000	2.0000			12.7500	15.0000	1.1250		
292.100	374.650	47.625	L555249	L555210	323.850	422.275	58.738	LM559048	LM559010
11.5000	14.7500	1.8750			12.7500	16.6250	2.3125		
292.100	393.700	63.500	84115	84155	325.438	596.900	136.525	EE720128	720236
11.5000	15.5000	2.5000			12.8125	23.5000	5.3750		
292.100	469.900	95.250	EE722115	722185	329.870	533.400	76.200	EE971298	972100
11.5000	18.5000	3.7500			12.9870	21.0000	3.0000		
292.100	508.000	123.032	EE224115	224199	329.895	415.925	47.625	L860049A	L860010
11.5000	20.0000	4.8438			12.9880	16.3750	1.8750		
292.100	520.700	114.300	EE296115	296204	330.200	415.925	47.625	L860048	L860010
11.5000	20.5000	4.5000			13.0000	16.3750	1.8750		
292.100	558.800	136.525	EE790114	790221	330.200	469.900	60.325	EE161300	161850
11.5000	22.0000	5.3750			13.0000	18.5000	2.3750		

The Bearing Dimension Catalog is not to be used as a design manual.  
The cone bore section does not include all available parts – see series for additional information.

# BEARING DIMENSIONS BY CONE BORE

BORE d	OUTSIDE DIAMETER D	WIDTH T	CONE	CUP	BORE d	OUTSIDE DIAMETER D	WIDTH T	CONE	CUP
330.200 13.0000	482.600 19.0000	66.675 2.6250	EE203130	203190	381.000 15.0000	590.550 23.2500	114.300 4.5000	M268730	M268710
330.200 13.0000	482.600 19.0000	85.725 3.3750	EE526130	526190	384.175 15.1250	441.325 17.3750	28.575 1.1250	LL365347	LL365310
333.000 13.1102	415.925 16.3750	47.625 1.8750	L860049AA	L860010	384.175 15.1250	546.100 21.5000	104.775 4.1250	HM266448	HM266410
333.375 13.1250	469.900 18.5000	90.487 3.5625	HM261049	HM261010	385.762 15.1875	514.350 20.2500	82.550 3.2500	LM665949	LM665910
338.138 13.3125	403.225 15.8750	33.338 1.3125	LL660749A	LL660711	387.248 15.2460	546.100 21.5000	87.312 3.4375	M667935	M667910
342.900 13.5000	450.850 17.7500	66.673 2.6249	LM361649	LM361610	393.700 15.5000	546.100 21.5000	76.200 3.0000	EE234154	234215
342.900 13.5000	457.098 17.9960	66.675 2.6250	LM961548	LM961510	396.875 15.6250	546.100 21.5000	76.200 3.0000	EE234156	234215
342.900 13.5000	533.400 21.0000	76.200 3.0000	EE971354	972100	396.875 15.6250	549.275 21.6250	85.725 3.3750	LM567943	LM567910
343.154 13.5100	450.850 17.7500	66.673 2.6249	LM361649A	LM361610	403.225 15.8750	460.375 18.1250	28.575 1.1250	LL566848	LL566810
346.075 13.6250	469.900 18.5000	60.325 2.3750	EE161363	161850	406.400 16.0000	508.000 20.0000	61.912 2.4375	L467549	L467510
346.075 13.6250	482.600 19.0000	66.675 2.6250	EE203136	203190	406.400 16.0000	546.100 21.5000	76.200 3.0000	EE234160	234215
346.075 13.6250	488.950 19.2500	95.250 3.7500	HM262748	HM262710	406.400 16.0000	546.100 21.5000	87.312 3.4375	M667944	M667910
349.250 13.7500	501.650 19.7500	90.488 3.5625	EE333137	333197	406.400 16.0000	549.275 21.6250	85.725 3.3750	LM567949	LM567910
354.012 13.9375	469.900 18.5000	60.325 2.3750	EE161394	161850	406.400 16.0000	574.675 22.6250	76.200 3.0000	EE285160	285226
355.600 14.0000	444.500 17.5000	60.325 2.3750	L163149	L163110	406.400 16.0000	590.550 23.2500	107.950 4.2500	EE833160X	833232
355.600 14.0000	469.900 18.5000	60.325 2.3750	EE161400	161850	406.400 16.0000	609.524 23.9970	87.312 3.4375	EE736160	736237
355.600 14.0000	501.650 19.7500	74.612 2.9375	EE231400	231975	406.400 16.0000	609.600 24.0000	92.075 3.6250	EE911600	912400
355.600 14.0000	501.650 19.7500	90.488 3.5625	EE333140	333197	406.400 16.0000	673.100 26.5000	88.900 3.5000	EE571602	572650
355.600 14.0000	673.100 26.5000	152.400 6.0000	EE121140	121265	406.400 16.0000	762.000 30.0000	180.975 7.1250	H969249	H969210
360.000 14.1732	480.000 18.8976	76.500 3.0118	X32972	Y32972	409.575 16.1250	546.100 21.5000	87.312 3.4375	M667947	M667910
361.950 14.2500	401.638 15.8125	21.430 .8437	LL762648	LL762610	409.575 16.1250	574.675 22.6250	76.200 3.0000	EE285162	285226
361.950 14.2500	406.400 16.0000	23.813 .9375	LL562749	LL562710	409.575 16.1250	590.550 23.2500	114.300 4.5000	M268744WS	M268710
368.249 14.4980	523.875 20.6250	101.600 4.0000	HM265049	HM265010	409.575 16.1250	635.000 25.0000	120.650 4.7500	M270730	M270710
368.300 14.5000	596.900 23.5000	95.250 3.7500	EE181453	182350	411.162 16.1875	609.600 24.0000	92.075 3.6250	EE911618	912400
368.300 14.5000	609.600 24.0000	142.875 5.6250	EE321145	321240	415.925 16.3750	590.550 23.2500	114.300 4.5000	M268749	M268710
371.475 14.6250	501.650 19.7500	74.612 2.9375	EE231462	231975	422.750 16.6437	476.250 18.7500	22.225 .8750	EL268247H	EL268210
374.650 14.7500	431.800 17.0000	28.575 1.1250	LL264648	LL264610	425.450 16.7500	590.550 23.2500	95.250 3.7500	M268749CR	M268710
374.650 14.7500	522.287 20.5625	85.724 3.3750	LM565943	LM565910	425.450 16.7500	685.698 26.9960	142.875 5.6250	EE328167	328269
377.825 14.8750	508.000 20.0000	63.500 2.5000	EE192148	192200	427.038 16.8125	533.400 21.0000	50.800 2.0000	L269140	L269110
377.825 14.8750	522.287 20.5625	85.724 3.3750	LM565946	LM565910	430.212 16.9375	603.250 23.7500	76.200 3.0000	EE241693	242375
377.825 14.8750	546.100 21.5000	104.775 4.1250	HM266444WS	HM266410	431.800 17.0000	533.400 21.0000	46.038 1.8125	80385	80325
381.000 15.0000	479.425 18.8750	49.213 1.9375	L865547	L865512	431.800 17.0000	533.400 21.0000	50.800 2.0000	L269143	L269110
381.000 15.0000	508.000 20.0000	63.500 2.5000	EE192150	192200	431.800 17.0000	552.450 21.7500	44.448 1.7499	80170	80217
381.000 15.0000	522.287 20.5625	85.724 3.3750	LM565949	LM565910	431.800 17.0000	571.500 22.5000	73.025 2.8750	EE239170	239225
381.000 15.0000	546.100 21.5000	104.775 4.1250	HM266446	HM266410	431.800 17.0000	571.500 22.5000	74.612 2.9375	LM869448	LM869410

15

## BEARING DIMENSIONS BY CONE BORE

BORE d	OUTSIDE DIAMETER D	WIDTH T	CONE	CUP	BORE d	OUTSIDE DIAMETER D	WIDTH T	CONE	CUP
431.800	603.250	76.200	EE241701	242375	514.350	736.600	88.900	EE982028	982900
17.0000	23.7500	3.0000			20.2500	29.0000	3.5000		
431.800	673.100	88.900	EE571703	572650	520.700	736.600	88.900	EE982051	982900
17.0000	26.5000	3.5000			20.5000	29.0000	3.5000		
431.902	685.698	177.800	EE650170	650270	533.400	635.000	50.800	LL575343	LL575310
17.0040	26.9960	7.0000			21.0000	25.0000	2.0000		
433.388	485.775	27.783	EL768949	EL768910	533.400	784.225	88.900	EE522102	523087
17.0625	19.1250	1.0938			21.0000	30.8750	3.5000		
441.325	660.400	91.280	EE737173	737260	536.575	761.873	146.050	M276449	M276410
17.3750	26.0000	3.5937			21.1250	29.9950	5.7500		
444.500	635.000	120.650	M270744	M270710	539.750	635.000	50.800	LL575349	LL575310
17.5000	25.0000	4.7500			21.2500	25.0000	2.0000		
447.675	552.450	44.448	80176	80217	546.100	736.600	76.200	EE542215	542290
17.6250	21.7500	1.7499			21.5000	29.0000	3.0000		
447.675	552.450	44.450	LL469949	LL469910	549.097	692.150	80.962	L476548	L476510
17.6250	21.7500	1.7500			21.6180	27.2500	3.1875		
447.675	635.000	120.650	M270749	M270710	549.275	603.250	27.782	EL875849	EL875810
17.6250	25.0000	4.7500			21.6250	23.7500	1.0938		
450.850	603.250	85.725	LM770945	LM770910	549.275	692.150	80.962	L476549	L476510
17.7500	23.7500	3.3750			21.6250	27.2500	3.1875		
456.794	761.873	142.875	EE425179A	425299	558.800	660.400	50.000	LL876449	LL876410
17.9840	29.9950	5.6250			22.0000	26.0000	1.9685		
457.073	573.088	74.613	L570648	L570610	558.800	723.900	73.025	EE647220	647285
17.9950	22.5625	2.9375			22.0000	28.5000	2.8750		
457.200	552.450	44.448	80180	80217	558.800	736.600	76.200	EE542220	542290
18.0000	21.7500	1.7499			22.0000	29.0000	3.0000		
457.200	573.088	74.613	L570649	L570610	558.800	736.600	88.106	EE843220	843290
18.0000	22.5625	2.9375			22.0000	29.0000	3.4687		
457.200	596.900	76.200	EE244180	244235	558.800	736.600	104.775	LM377448	LM377410
18.0000	23.5000	3.0000			22.0000	29.0000	4.1250		
457.200	603.250	85.725	LM770949	LM770910	558.800	901.573	134.938	EE327220	327355
18.0000	23.7500	3.3750			22.0000	35.4950	5.3125		
457.200	615.950	85.725	LM272235	LM272210	571.500	660.400	46.037	LL777148	LL777110
18.0000	24.2500	3.3750			22.5000	26.0000	1.8125		
457.200	660.400	91.280	EE737181	737260	571.500	812.800	155.575	M278749	M278710
18.0000	26.0000	3.5937			22.5000	32.0000	6.1250		
457.200	730.148	120.650	671800	672873	584.200	685.800	49.213	LL778149	LL778110
18.0000	28.7460	4.7500			23.0000	27.0000	1.9375		
463.550	622.300	101.206	LM671644	LM671610	584.200	709.612	58.737	L778149	L778110
18.2500	24.5000	3.9845			23.0000	27.9375	2.3125		
476.250	565.150	41.275	LL771948	LL771911	584.200	762.000	107.155	LM778549	LM778510
18.7500	22.2500	1.6250			23.0000	30.0000	4.2187		
479.425	679.450	128.587	M272749	M272710	584.200	901.700	150.021	EE662303	663550
18.8750	26.7500	5.0625			23.0000	35.5000	5.9063		
482.600	596.900	53.975	80480	80418	585.788	771.525	124.998	LM278849	LM278810
19.0000	23.5000	2.1250			23.0625	30.3750	4.9212		
482.600	615.950	85.725	LM272249	LM272210	596.900	685.800	31.750	680235	680270
19.0000	24.2500	3.3750			23.5000	27.0000	1.2500		
482.600	634.873	80.963	EE243190	243250	602.945	787.400	93.663	EE649236X	649310
19.0000	24.9950	3.1875			23.7380	31.0000	3.6875		
488.671	660.400	93.662	EE640191	640260	607.720	787.400	93.663	EE649239	649310
19.2390	26.0000	3.6875			23.9260	31.0000	3.6875		
488.950	634.873	84.138	LM772748	LM772710	609.346	787.400	93.663	EE649238	649310
19.2500	24.9950	3.3125			23.9900	31.0000	3.6875		
488.950	660.400	93.662	EE640192	640260	609.397	762.000	95.250	L879946	L879910
19.2500	26.0000	3.6875			23.9920	30.0000	3.7500		
489.026	634.873	80.963	EE243192	243250	609.600	762.000	95.250	L879947	L879910
19.2530	24.9950	3.1875			24.0000	30.0000	3.7500		
498.323	634.873	80.963	EE243197	243250	609.600	774.700	85.725	L580049	L580010
19.6190	24.9950	3.1875			24.0000	30.5000	3.3750		
498.475	634.873	80.963	EE243195	243250	609.600	787.400	93.663	EE649240	649310
19.6250	24.9950	3.1875			24.0000	31.0000	3.6875		
501.650	596.900	53.975	80487	80418	609.600	812.800	82.550	EE743240	743320
19.7500	23.5000	2.1250			24.0000	32.0000	3.2500		
501.650	711.200	136.525	M274149	M274110	615.950	708.025	41.275	LL580049	LL580010
19.7500	28.0000	5.3750			24.2500	27.8750	1.6250		
508.000	736.600	88.900	EE982003	982900	635.000	736.600	57.150	80780	80720
20.0000	29.0000	3.5000			25.0000	29.0000	2.2500		
508.000	838.200	146.050	EE426200	426330	635.000	933.450	179.387	M281635	M281610
20.0000	33.0000	5.7500			25.0000	36.7500	7.0625		

The Bearing Dimension Catalog is not to be used as a design manual.  
The cone bore section does not include all available parts – see series for additional information.

## BEARING DIMENSIONS BY CONE BORE

BORE d	OUTSIDE DIAMETER D	WIDTH T	CONE	CUP	BORE d	OUTSIDE DIAMETER D	WIDTH T	CONE	CUP
646.112 25.4375	857.250 33.7500	141.288 5.5625	LM281049	LM281010	889.000 35.0000	1123.950 44.2500	120.650 4.7500	EE158350	158442
660.235 25.9935	812.800 32.0000	95.250 3.7500	L281146	L281110	939.800 37.0000	1193.800 47.0000	101.600 4.0000	LL787840	LL787815
660.400 26.0000	812.800 32.0000	95.250 3.7500	L281147	L281110	950.000 37.4016	1270.000 50.0000	158.000 6.2205	L687645	L687619X
660.400 26.0000	854.923 33.6584	85.113 3.3509	EE749260	749334	977.900 38.5000	1130.300 44.5000	66.675 2.6250	LL687949	LL687910
660.400 26.0000	930.275 36.6250	149.225 5.8750	LM282534	LM282510	1014.412 39.9375	1270.000 50.0000	101.600 4.0000	EE168399	168500
660.400 26.0000	939.800 37.0000	136.525 5.3750	EE538260	538370	1016.000 40.0000	1270.000 50.0000	101.600 4.0000	EE168400	168500
673.100 26.5000	793.750 31.2500	66.675 2.6250	LL481448	LL481411	1063.625 41.8750	1219.200 48.0000	65.088 2.5625	LL788345	LL788310
679.450 26.7500	901.700 35.5000	142.875 5.6250	LM281849	LM281810	1066.800 42.0000	1219.200 48.0000	65.088 2.5625	LL788349	LL788310
682.625 26.8750	965.200 38.0000	185.737 7.3125	M282247	M282210	1066.800 42.0000	1320.800 52.0000	95.250 3.7500	EE776420	776520
682.625 26.8750	1035.050 40.7500	198.438 7.8125	M283433	M283410	1092.200 43.0000	1320.800 52.0000	95.250 3.7500	EE776430	776520
685.800 27.0000	876.300 34.5000	93.662 3.6875	EE655270	655345	1155.700 45.5000	1435.100 56.5000	121.030 4.7650	EE277455	277565
698.500 27.5000	819.150 32.2500	63.500 2.5000	LL382149	LL382110	1270.000 50.0000	1435.100 56.5000	69.850 2.7500	LL889049	LL889010
708.025 27.8750	930.275 36.6250	146.050 5.7500	LM282548X	LM282510	1346.200 53.0000	1574.800 62.0000	98.425 3.8750	EE188530	188621
709.976 27.9518	899.924 35.4301	110.000 4.3307	L882449	L882410	1562.100 61.5000	1806.575 71.1250	127.000 5.0000	EE299615	299711
711.200 28.0000	914.400 36.0000	85.725 3.3750	EE755280	755360	1689.100 66.5000	1844.675 72.6250	68.262 2.6875	LL789749	LL789710
719.930 28.3437	914.400 36.0000	84.137 3.3125	EE755282	755360					
723.900 28.5000	914.400 36.0000	84.137 3.3125	EE755285	755360					
736.600 29.0000	825.500 32.5000	31.750 1.2500	LL582949	LL582910					
749.300 29.5000	965.200 38.0000	93.663 3.6875	EE752295	752380					
749.300 29.5000	990.600 39.0000	159.500 6.2795	LM283649	LM283610					
758.825 29.8750	901.700 35.5000	66.675 2.6250	LL783647	LL783610					
759.925 29.9183	889.000 35.0000	69.849 2.7500	LL483448	LL483418					
759.925 29.9183	889.000 35.0000	88.900 3.5000	L183448	L183410					
762.000 30.0000	889.000 35.0000	69.849 2.7500	LL483449	LL483418					
762.000 30.0000	889.000 35.0000	69.850 2.7500	EE175300	175350					
762.000 30.0000	889.000 35.0000	88.900 3.5000	L183449	L183410					
762.000 30.0000	901.700 35.5000	66.675 2.6250	LL783649	LL783610					
762.000 30.0000	965.200 38.0000	93.663 3.6875	EE752300	752380					
774.700 30.5000	965.200 38.0000	93.663 3.6875	EE752305	752380					
801.688 31.5625	914.400 36.0000	58.738 2.3125	LL584449	LL584410					
825.500 32.5000	1041.400 41.0000	93.662 3.6875	EE763325	763410					
836.612 32.9375	1041.400 41.0000	93.662 3.6875	EE763329	763410					
838.200 33.0000	1041.400 41.0000	93.662 3.6875	EE763330	763410					
857.250 33.7500	1092.200 43.0000	120.650 4.7500	EE157337	157430					
863.600 34.0000	1130.300 44.5000	174.625 6.8750	LM286249	LM286210					

15



---

The Timken Company has created a family of literature to assist customers in specifying the appropriate bearing for each application and then maximizing its useful life. To assist that effort, reference material has been developed to help bearing selection for a market segment's specific needs, to implement proper maintenance practices and to utilize the full spectrum of design and service solutions.

Please contact your Timken sales representative to receive copies of the following literature:

**MARKET SPECIFIC LITERATURE**

- The Right Solution for the Rolling Mill Industry
- Precision Tapered Roller Bearings for Machine Tools
- Tapered Roller Bearings for Printing Presses

**MAINTENANCE LITERATURE**

- Bearing Maintenance Manual for Transportation Applications
- Bearing Maintenance Manual for Mobile Industrial Equipment
- Bearing Maintenance Manual for General Industrial Equipment
- Bearing Damage Analysis Poster
- Maintaining Quality on TQO Bearings

**PRODUCT-SPECIFIC LITERATURE**

- Aircraft Landing Wheel Bearings
- AP Bearings for Industrial Applications
- AquaSpexx Corrosion-Resistant Bearings
- Bearings Plus Service Kits
- Debris-Resistant Bearings
- Precision Crossed Roller Bearings
- Spexx Performance Bearings
- TNASWH Bearings
- Thrust Bearings

**LITERATURE ON TIMKEN SERVICES**

- Bearing Express
- Gear Express
- Industrial Bearing Services
- Mill Express
- Spacer Assembly Value Express (SAVE)

**Welcome to Timken Online**

Worldwide Leader in  
Bearings & Steel

Investor Information  
Innovative Solutions  
Corporate Overview  
R&D/New Products

News  
Employment  
Affiliations

*www.timken.com*

Technology of The Timken Company through the power of the web.  
Look to [www.timken.com](http://www.timken.com) for the latest updates to Timken dimensional information

**TIMKEN**

**WORLDWIDE LEADER IN BEARINGS AND STEEL**